



# LUND UNIVERSITY

## Simultaneous OH- and Formaldehyde-LIF Measurements in an HCCI Engine

Collin, Robert; Nygren, Jenny; Richter, Mattias; Aldén, Marcus; Hildingsson, Leif; Johansson, Bengt

*Published in:*

SAE Transactions, Journal of Fuels and Lubricants

2003

[Link to publication](#)

*Citation for published version (APA):*

Collin, R., Nygren, J., Richter, M., Aldén, M., Hildingsson, L., & Johansson, B. (2003). Simultaneous OH- and Formaldehyde-LIF Measurements in an HCCI Engine. *SAE Transactions, Journal of Fuels and Lubricants*, 112(4), 2479-2486. <http://www.sae.org/technical/papers/2003-01-3218>

*Total number of authors:*

6

### General rights

Unless other specific re-use rights are stated the following general rights apply:

Copyright and moral rights for the publications made accessible in the public portal are retained by the authors and/or other copyright owners and it is a condition of accessing publications that users recognise and abide by the legal requirements associated with these rights.

- Users may download and print one copy of any publication from the public portal for the purpose of private study or research.
- You may not further distribute the material or use it for any profit-making activity or commercial gain
- You may freely distribute the URL identifying the publication in the public portal

Read more about Creative commons licenses: <https://creativecommons.org/licenses/>

### Take down policy

If you believe that this document breaches copyright please contact us providing details, and we will remove access to the work immediately and investigate your claim.

LUND UNIVERSITY

PO Box 117  
221 00 Lund  
+46 46-222 00 00

# Simultaneous OH- and Formaldehyde-LIF Measurements in an HCCI Engine

Robert Collin, Jenny Nygren, Mattias Richter and Marcus Aldén  
Division of Combustion Physics, Lund Institute of Technology

Leif Hildingsson and Bengt Johansson  
Division of Combustion Engines, Lund Institute of Technology

Copyright © 2003 SAE International

## ABSTRACT

Simultaneous OH- and formaldehyde LIF measurements have been performed in an HCCI engine using two laser sources working on 283 and 355 nm, respectively. Two ICCD camera systems, equipped with long-pass filters, were used to collect the LIF signals. The simultaneous images of OH and formaldehyde were compared with heat-release calculated from the pressure-trace matching the cycle for the LIF measurements.

The measurements were performed on a 0.5 l single-cylinder optical engine equipped with port-fuel injection system. A blend of iso-octane and n-heptane was used as fuel and the compression ratio was set to 12:1. The width of the laser sheet was 40 mm and hence covered approximately half of the cylinder bore.

At some 20 CAD BTDC low temperature reactions is present and formaldehyde is formed. The formaldehyde signal is then rather constant until the main heat-release starts just before TDC, where the signal decreases rapidly to low values. From some 15 CAD to 5 CAD BTDC the formaldehyde is uniformly distributed in the imaged area. As formaldehyde decreases, OH increases and follows the main rate of heat release curve, though with a slight lag in phase. Thereafter OH is formed in the areas from which the formaldehyde has disappeared and the OH signal is present to some 20 CAD ATDC.

## INTRODUCTION

When running an engine in HCCI-mode (HCCI=Homogeneous Charge Compression Ignition) the fuel and air are allowed to mix in the intake port, or in the cylinder for DI-engines, in order to create a

homogeneous charge. The charge is then compressed until auto-ignition occurs. A characteristic feature with HCCI that distinguish it from more conventional combustions modes, i.e. Otto or Diesel, is that ignition occurs simultaneously at multiple sites [1]. This results in a combustion that occurs through distributed reactions throughout the bulk volume. As the whole bulk burns almost simultaneously, the overall combustion rate is very high. Consequently, highly diluted mixtures have to be used in order to limit the rate of heat release.

The major advantage with HCCI compared to the diesel concept is low NOX emissions in combination with significantly less soot formation [2]. In conventional diesel engines, a reduction of NOx most often results in an increase of soot volume fraction and vice versa. An advantage for the HCCI, when compared to an SI engine, is a higher efficiency at part load. In addition, the cycle-to-cycle variations in Indicated Mean Effective Pressure (IMEP) are very small for HCCI combustion [3]. A major challenge associated with HCCI is the difficulty to control the timing of the ignition so to that the combustion occurs close to TDC (TDC=Top Dead Center). Since the ignition process relies on spontaneous auto-ignition there are no direct means to control the onset of combustion. However, by adjusting remote operating parameters, like inlet air temperature, fuel properties or exhaust gas recirculation (EGR) rate, ignition timing can be controlled [4, 5].

The ignition and combustion processes can be studied by visualizing the distributions of formaldehyde and OH radicals. The formaldehyde molecule is formed as an intermediate species when combusting hydrocarbons. The formation occurs through low temperature oxidation in an early phase of the ignition process. Formaldehyde

is then being consumed later in the combustion process. Formaldehyde is also associated with the low temperature reactions that occur when certain mixtures of hydrocarbon fuels and air are close to the explosion limit. Hence, formaldehyde is an indicator of the first stage of ignition and a marker for zones with low temperature reactions. Planar laser induced fluorescence from formaldehyde has been used earlier for visualization of self-ignition centres in SI-engines [6], for studying the ignition of Diesel sprays [7] and for characterization of the Controlled Auto Ignition (CAI) combustion concept [8].

The OH radical is an important intermediate that is formed during combustion. OH is formed in flame regions with high temperature and there is a strong coupling between maximum temperature and maximum OH concentration. For cases where conventional flame fronts exist, the OH radical is often used as a marker of both flame fronts and of burnt regions. Because of the combustion temperature in an HCCI engine being lower than in an Otto engine, the OH concentration in an HCCI engine is significantly lower compared to what is found in an Otto engine. However, OH can still be used as a marker of regions where HCCI combustion is ongoing [9].

In this work the ignition and combustion phases for a HCCI engine are investigated with laser-induced fluorescence, LIF, on both formaldehyde and OH simultaneously. For this purpose two laser sources combined with two ICCD detector systems were used.

## EXPERIMENTAL

### ENGINE SETUP

The work presented was performed on a 0.5 l single-cylinder optical HCCI engine, the specifications of which are summarized in table 1. The engine was equipped with port-fuel injection system, which generates a principally homogeneous charge, and a blend of 50% iso-octane and 50% n-heptane was used as fuel. The

Type:	Four-valve diesel engine
Engine speed:	1200 rpm
Displacement (one cylinder):	0.5 l
Bore:	81 mm
Stroke:	93 mm
Compression ratio:	12:1
Fuel:	50% iso-octane 50% n-heptane

Table 1. Specifications of the test engine.

compression ratio was set to 12:1 and the engine was run with a lambda between 2.9 and 3.3. A wide-band lambda sensor, ETAS LA3, was used to measure the air/fuel-ratio. To maintain 50% heat released at 5 – 6 CAD ATDC the inlet air temperature had to be constantly changed. The engine was started at an inlet air temperature of 120°C and during the measurement it had to be constantly decreased and the temperature at the end of the measurement was between 80°C and 90°C. Horizontal optical access to the upper part of the cylinder liner was obtained through a full quartz ring with a height of 25 mm. An elongated piston and a 45-degree mirror provided for optical access from below through a piston window with a diameter of 58 mm.

### OPTICAL SETUP

Simultaneous OH- and formaldehyde-LIF measurements were performed in the HCCI engine using two laser sources fired with a time separation of 1  $\mu$ s in order not to disturb each other. For the OH-LIF a frequency doubled Nd:YAG was used to pump a dye laser with Rhodamin 590. The dye laser output was further frequency doubled using a single BBO crystal and the resulting pulse energy was approximately 30 mJ near 283 nm. OH was excited using the Q1(8) transition in the  $v''=0, v'=1$  band of the A2  $\rightarrow$  X2  $\rightarrow$  system. For the formaldehyde-LIF the third harmonic (355 nm) of a Nd:YAG was used with a pulse energy of approximately 75 mJ. The technique for formaldehyde LIF is described elsewhere [10]. The laser beams from the two laser

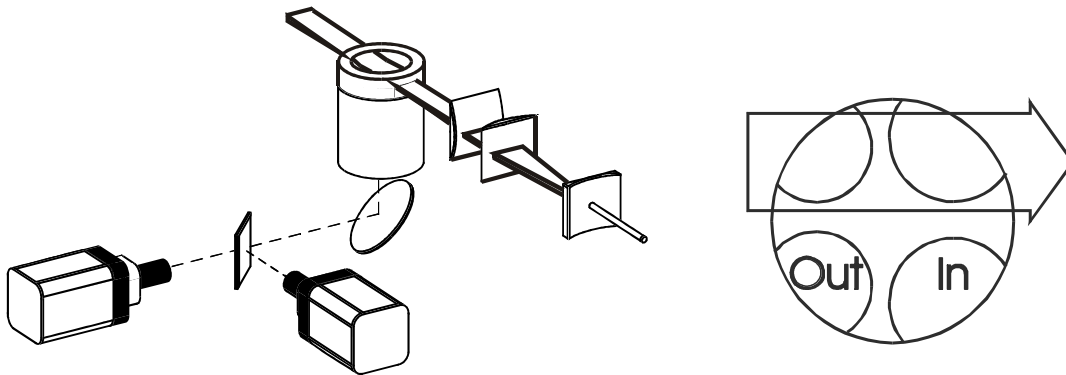

Figure 1. Schematic overview of the experimental setup. Left: Laser and detector alignment through the engine. Right: Position of the imaged area relative to the combustion chamber.

sources were lined on top of each other and thereafter shaped, with the same optics, into a horizontal laser sheet with a width of 40 mm. The sheet was focused with an  $f=300$  mm cylindrical lens into the combustion chamber, 3 mm below the roof. The laser sheets were lined in order to cover half the cylinder, see figure 1. Two ICCD-camera systems (Princeton Instruments PI-MAX), equipped with UV-lenses (Nikon,  $f = 105$  mm,  $f\#=2.5$ ) were used to collect the OH- and formaldehyde-LIF signals and a high-reflective mirror centered at 308 nm and with a transmittance of approximate 70% at 355 nm was used as beam splitter to separate the two LIF signals from each other. LIF from OH was detected in the (1,1) and (0,0) bands near 309 nm using two 283-nm long-pass filters and one UG11 filter in front of the detector. LIF from formaldehyde was detected using two GG395 Shott-filters.

### SPECTRAL INVESTIGATION

The formaldehyde signal was recorded spectrally in order to confirm that the signal detected by the formaldehyde-detector was obtained from formaldehyde. This investigation was performed by replacing the ICCD-system collecting the formaldehyde-LIF with a spectrograph. The obtained spectrum, shown in figure 2, shows the LIF signal from formaldehyde and is similar to emission spectra of formaldehyde obtained in a heated cell. The spectrum has a broad structure compared with similar spectra obtained at lower temperatures. To some extent, this can be explained by a broadening of the bands since more vibronic and ro-vibronic levels would be populated at higher temperatures [11]. The peak shown at 532 nm in figure 2 originates from the frequency-doubled component used for generating the laser radiation at 355 nm.

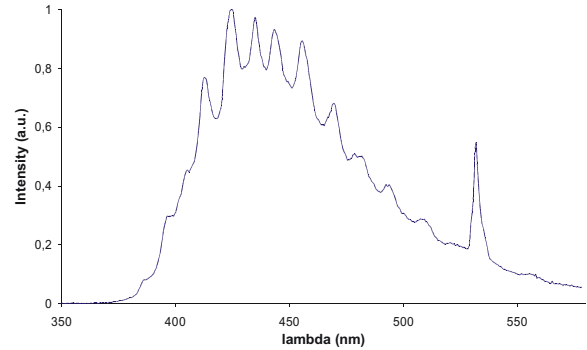

Figure 2. Spectrally resolved formaldehyde signal from the HCCI-cycle.

### RESULTS

For every measured crank-angle position background images, from the corresponding motored case, were collected. These background images were subtracted from the measured LIF images and the remaining noise level were set to zero in the images. By this, only information about the LIF signal intensity was remaining in the OH- and formaldehyde-images. For clarity the intensity images shown in the paper are flattened in order to see the spatial structures in the images more easily. This procedure is shown in figure 3 where the intensity images (to the left in figure 3) are flattened to one single color before the OH- and formaldehyde images are combined to one single image (to the right in figure 3).

Measurements were performed in a wide time range, starting before the onset of the low temperature region (LTR), through all combustion and until late in the expansion stroke. For every measured crank-angle position 20 image-pairs were collected and the corresponding pressure-traces were recorded. Those temporal positions of each image acquisition were

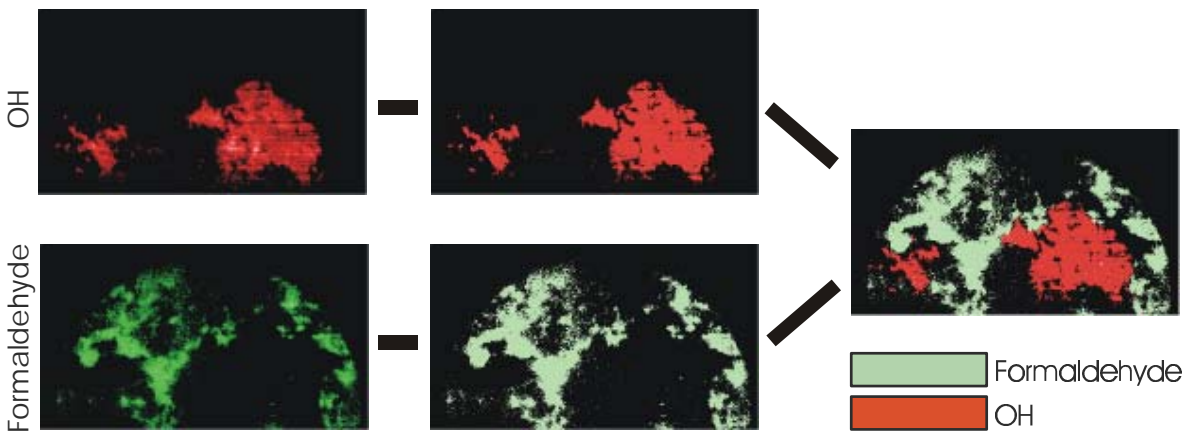

Figure 3. Procedure for representation of OH- and formaldehyde-LIF images. To the left are intensity images of OH and formaldehyde shown. The second column represents the flattened images. The combined OH- and formaldehyde image is shown to the right.

marked in the pressure-traces. In figure 4 a selected series of LIF images obtained from different crank-angles is shown to exemplify the formation and consumption of formaldehyde and OH during the combustion when the engine is run with a lambda of 3.0-3.1. Rather than presenting average images, however, single-shot images representative for each position are presented. This is because averaging smears out the shape of the spatial distribution of the OH- and formaldehyde signals. In figure 5 the average rate of heat-release for 100 individual cycles collected in connection with the LIF images obtained at 10 CAD ATDC is shown. Also shown in this figure are the mean values of the total sum-up intensity for the 20 single-shot images obtained at each measured crank-angle position. These mean values are normalized to the maximum value of the OH- and formaldehyde signals, respectively. To cover the interval from the onset of low temperature reactions until late in the expansion stroke the measurement series had to be divided into two parts (indicated by 1 and 2 in figure 5) in order not to overheat the engine.

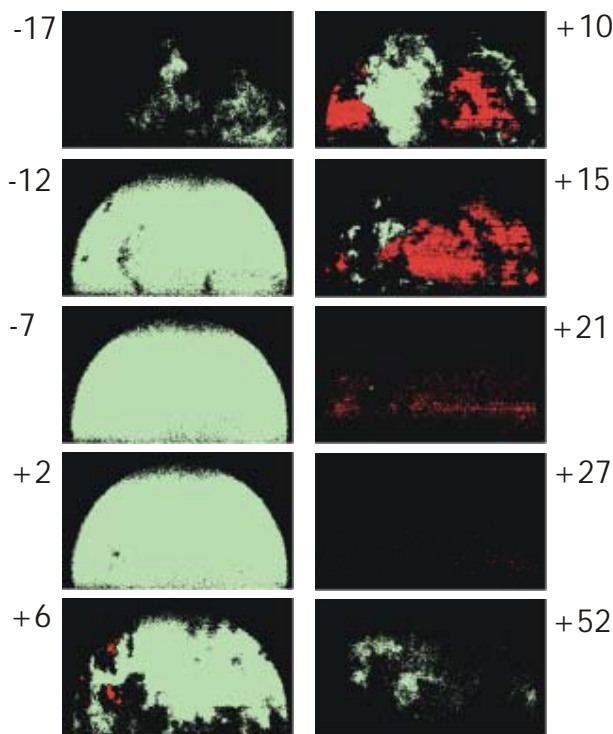

Figure 4. Single-shot images from onset of LTR combustion until the end of the main combustion. Formaldehyde is shown in green/light gray and OH is shown in red/dark gray.

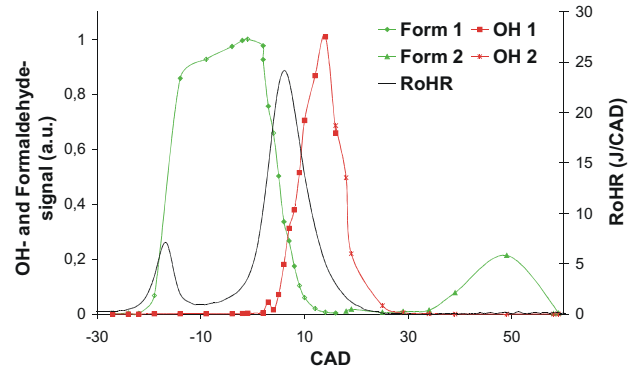

Figure 5. Average rate of heat-release and average OH- and formaldehyde-signals for the measurement series shown in figure 4.

From figure 4 and 5 it can be seen that a low temperature region is present at some 20 CAD BTDC and formaldehyde is formed. From some 15 CAD to 5 CAD BTDC the formaldehyde is uniformly distributed in the imaged area and this uniformly distributed formaldehyde signal remains until the main heat release starts just before TDC. Here, the signal decreases rapidly to low values and as formaldehyde decreases OH increases and follows the main rate of heat-release curve, though with a slight lag in phase. Thereafter OH is formed in the areas from which the formaldehyde has disappeared and the OH signal is present to some 20 CAD ATDC. OH signal do not fill the entire combustion chamber because the signal is prompt and disappear when the combustion is over. Everything in the combustion chamber does not burn at the same time. Later in the expansion stroke, around 50 CAD ATDC, signal starts to appear again at the formaldehyde-detector. This signal may come from formaldehyde but this is not confirmed since no spectral investigation of the signal was made this late in the cycle. Therefore it is possible that this signal may come from other species that fluoresce when excited by 355 nm laser radiation.

Figure 6 is a zoomed-in version of the graph in figure 5. Here only the first half of the measurement series is shown, but with the standard deviation of the measurements that build each averaged point included. From this it can be seen that the standard deviation is small up to the point where the main combustion takes place, especially for the OH formation. The standard deviation for the undefined signal later in the cycle (not seen in figure 6) is of the same magnitude as for formaldehyde during the main combustion.

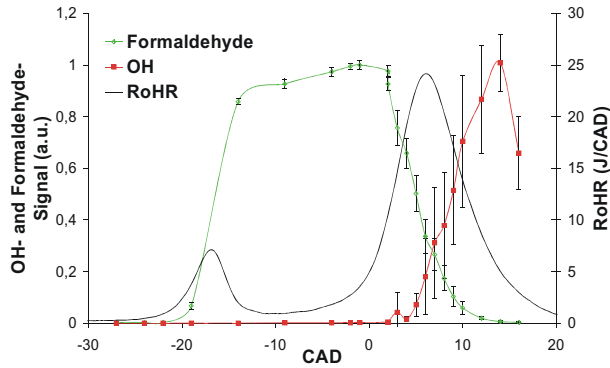

Figure 6. Average OH- and formaldehyde signals with the standard deviation of the measurement points included.

In figure 5 and 6 the LIF measurements are represented by the average sum-up intensity of the images for each measurement position. Another way to get an overview of the measurement series is to represent each LIF image-pair by the surface that is obtained by the signal of formaldehyde and OH, respectively, as in figure 4, and build the average surface for each measurement position. This representation ends-up in a graph similar to those in figure 5 and 6 with the difference that, since the image is flattened, the LIF signal dependence of laser power, pressure, number density, etc. is removed. This representation is shown in figure 7 where the average surface of the signals is normalized to the total imaged area that can be occupied with signal.

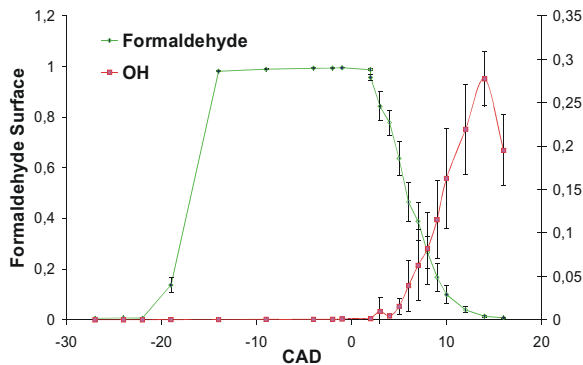

Figure 7. Average surface obtained with signal for OH and formaldehyde for each measurement position

Shown trends of formaldehyde and OH in figure 7 are similar with those shown in figure 6, including similar standard deviations. It can be seen that formaldehyde fills the total imaged area between the low temperature region and the main combustion (high temperature region, HTR) which in this region result in a constant level with a very small standard deviation. In average OH fills almost 30 % of the imaged area before it starts to disappear.

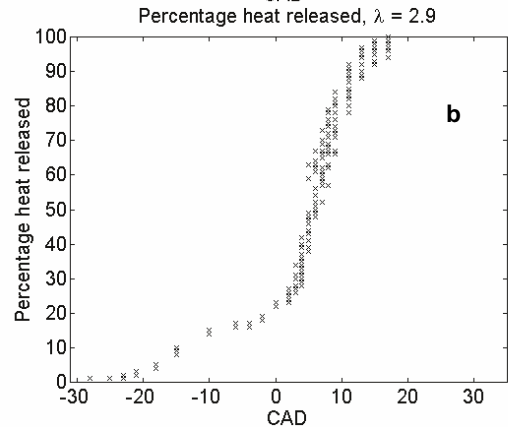
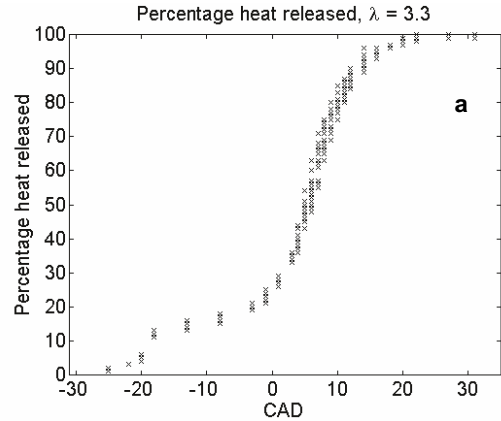

Figure 8. Percentage heat released as a function of CAD. Figure 8a (leaner) above; 8b (richer) below.

By plotting the percentage of heat released, as shown in figure 8, it is seen that there is some spread of the data for each CAD. For each CAD 20 images were recorded and thus also 20 individual pressure traces. Each one is represented by an x. Due to the rapid combustion phase of HCCI there are some CAD-positions where the heat released is spread over as much as 25% of the vertical axis. During the period before TDC and the period after 20 ATDC the combustion is much more stable and doesn't have such a large spread, see figure 8a. Due to rounding of the results there seem to be only two x for the two last CAD-positions in figure 8a, but there are 20; they are on top of each other. The LTR/pre-reactions can be seen contributing with about 30% of the total amount of heat released. It should be noted that a heat release of 100% means that the combustion is finished, but this doesn't imply that all of the fuel that was injected has been consumed; on the contrary there is probably a considerable amount of unburnt fuel trapped in the inevitable crevices that occur when using an engine with optical components. Figure 8a shows a plot for one case with a slightly leaner mixture,  $\lambda = 3.3$ , than the mixture used for figure 6 and 7, which was 3.0 to 3.1; 8b is for a case with a somewhat richer mixture, about  $\lambda = 2.9$ . To maintain 50% heat released at 5 – 6 CAD ATDC the inlet air temperature had to be constantly changed.

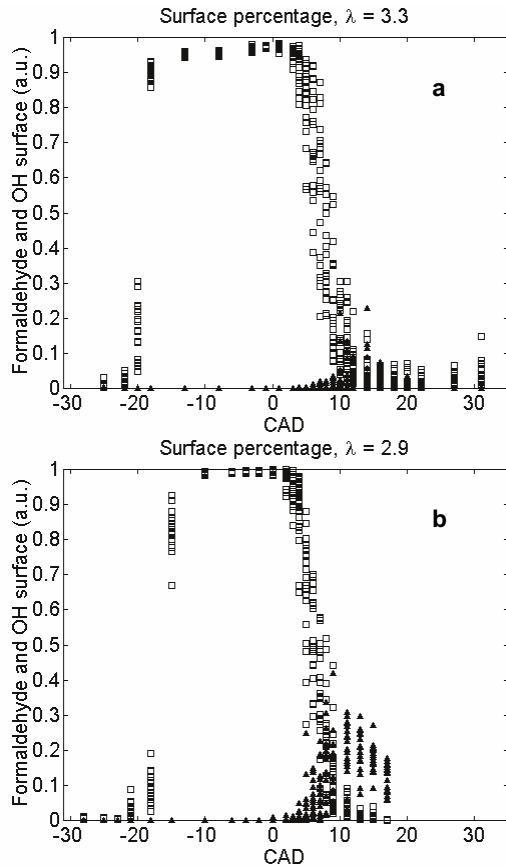

Figure 9. Normalized surface of formaldehyde and OH as a function of CAD. Figure 9a (leaner) above; 9b (richer) below. Squares represent formaldehyde and triangles represent OH.

In figure 9 the normalized surface percentage filled by formaldehyde and OH is plotted as a function of CAD, for the 20 cycles per CAD position. The maximum formaldehyde surface present in each measured case was determined and all measured surfaces were subsequently normalized to the greatest of the maximum formaldehyde surfaces. A large spread in signal level can be seen for a given CAD, especially for the OH signal.

As both the percentage heat released and PLIF signal intensity vary for a given CAD it is interesting to plot PLIF signal vs. percentage heat released instead. Figure 10 shows this.

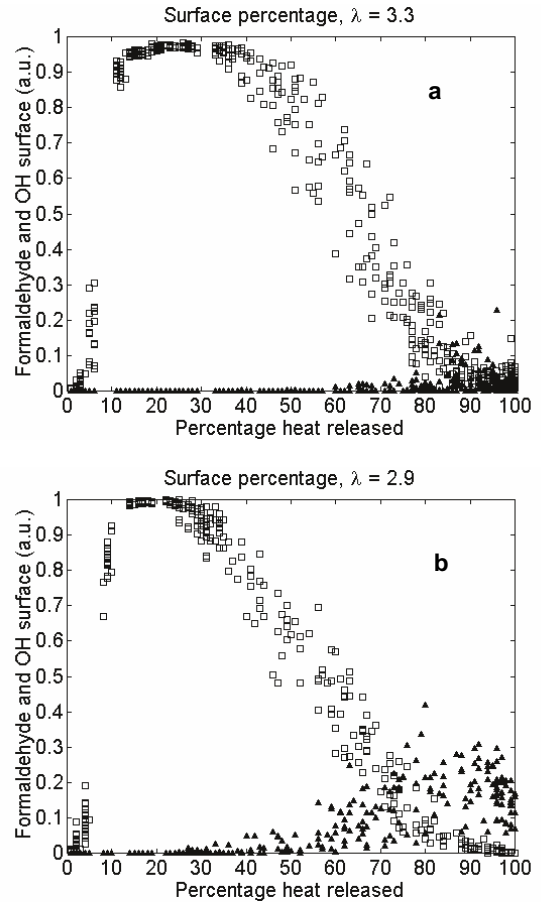

Figure 10. Normalized surface of formaldehyde and OH as a function of percentage heat released. Figure 10a (leaner) above; 10b (richer) below. Squares represent formaldehyde and triangles represent OH

As seen in figure 10, where the normalized surface area of formaldehyde and OH is plotted as a function of percentage heat released, the formaldehyde is always present in almost the whole viewed area during the time from 10% to 30% heat released, which translates to somewhat before 15 BTDC to around TDC when comparing figure 10 with figure 9; this is where the LTR occur. The normalization is the same as for figure 9. In the plot, squares represent formaldehyde surface and triangles represent OH surface. The decreasing trend of the formaldehyde surface is clearly seen, with a larger spread for the leaner case (figure 10a) than for the case with a slightly richer mixture. The fluctuation of the OH-surface is considerable, which is also seen in figure 6 by studying the standard deviations for the case with  $\lambda = 3.0 - 3.1$ . One notable observation is that there is no OH signal until around 60% heat released for figure 10a, and earlier, at about 40% heat released for figure 10b.

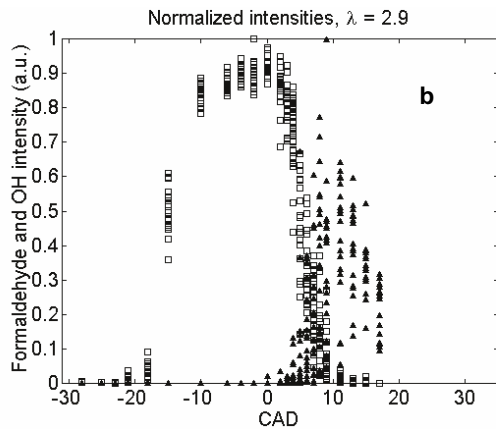
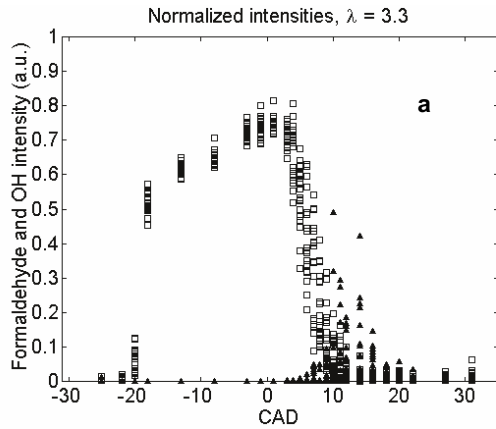

Figure 11. Normalized formaldehyde and OH intensities as a function of CAD. Figure 11a (leaner) above; 11b (richer) below. Squares represent formaldehyde and triangles represent OH.

In figure 11 it can clearly be seen that the intensities of formaldehyde and OH are low in the case of the leaner mixture compared with the richer mixture. The intensity of formaldehyde was normalized to the highest formaldehyde intensity in any of the studied cases; the same was done for the OH-intensities.

Figure 12a and b shows the normalized formaldehyde and OH intensities as a function of percentage heat released. The normalization is the same as for figure 11.

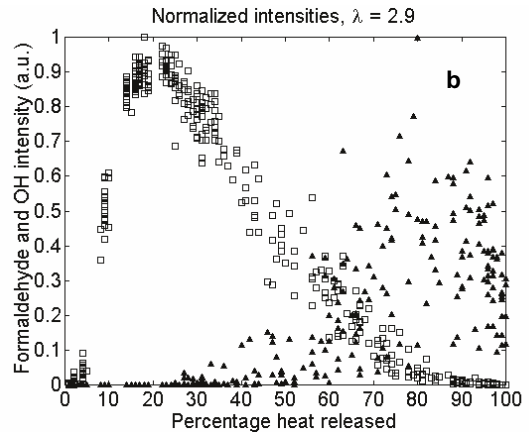
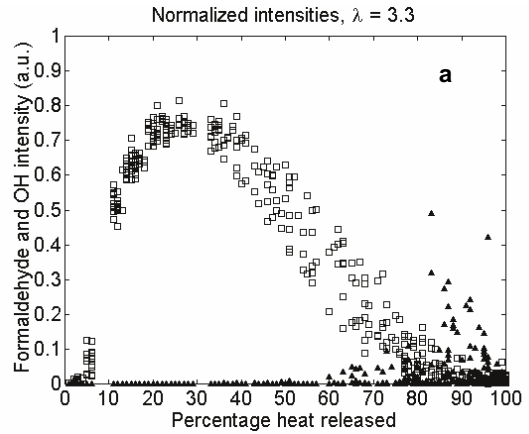

Figure 12. Normalized formaldehyde and OH intensities as a function of percentage heat released for the leaner case. Squares represent formaldehyde and triangles represent OH. Figure 12a (leaner) above; 12b (richer) below.

## CONCLUSIONS

- The concentration and location of formaldehyde and OH were measured in an optical engine using two separate PLIF systems.
- The engine was operated with a 50/50 mixture of iso-octane and n-heptane. This generated a low released some 20 CAD before the high temperature reactions.
- At the start of the low temperature reactions clouds of formaldehyde were detected. More formaldehyde was detected as the LTR progressed.
- The formaldehyde filled the entire measured region after the LTR ended.



- At the start of the HTR holes in the homogeneous formaldehyde signal were detected. At peak heat release rate the signal has gone down to less than 50 of its maximum.
- The PLIF signal of OH is detected only in regions where formaldehyde is absent. Under a relatively long period OH and formaldehyde is detected simultaneously but never in the same location.
- The PLIF signal strength of OH is lagging the rate of heat release by roughly 8 CAD. Max OH is detected when most of the fuel is consumed and thus close to peak in-cylinder temperature.
- Running the engine with a lean mixture makes the OH signal appear at higher percentage heat released compared to a rich mixture. This could be due to the lower amount of heat released with the leaner mixture and thus lower temperature during the cycle.
- Significant cycle to cycle variations exist during the HTR combustion process whereas the LTR is very stable. This gives very low cycle to cycle variation of the formation of formaldehyde but much more variations in the destruction at the first phase of HTR. Both formation and destruction of OH exhibited large cycle to cycle variations.

## ACKNOWLEDGMENTS

This work was financed by The Green Car project and The Centre of Competence. The authors are grateful for this support.

## CONTACT

Corresponding author: Robert Collin, Division of Combustion Physics, Lund Institute of Technology, PO Box 118, S-221 00, LUND, Sweden, phone: +46 46 2224565, fax: +46 46 2224542, e-mail: [Robert.collin@forbrf.lth.se](mailto:Robert.collin@forbrf.lth.se).

## REFERENCES

1. A. Hultqvist, M. Christensen, B. Johansson, A. Franke, M. Richter, M. Aldén: "A Study of the Homogeneous Charge Compression Ignition Combustion Process by Chemiluminescence Imaging", SAE1999-01-3680.
2. M. Christensen, A. Hultqvist, B. Johansson: "Demonstrating the Multi Fuel Capability of a Homogeneous Charge Compression Ignition Engine with Variable Compression Ratio", SAE1999-01-3679.
3. S. Onishi, S. Hong Jo, K. Shoda, P. Do Jo, S. Kato: "Active Thermo-Atmosphere Combustion (ATAC) – A New Combustion Process for Internal Combustion Engines", SAE790501.
4. J-O. Olsson, P. Tunestal, B. Johansson: "Closed-Loop Control of an HCCI Engine", SAE2001-01-1031.
5. J-O. Olsson, P. Tunestal, G. Haraldsson, B. Johansson: "A Turbo Charged Dual Fuel HCCI Engine", SAE2001-01-1896.
6. R. Schießl, A. Dreizler, U. Maas, A. Grant, P. Ewart: "Double-Pulse PLIF imaging of self-ignition centers in an SI engine", SAE2001-01-1925.
7. H. Kosaka, V. H. Drewes, L. Catalfamo, A. A. Aradi, N. Iida and T. Kamimoto: "Two-Dimensional Imaging of Formaldehyde Formed During the Ignition Process of a Diesel Fuel Spray", SAE2000-01-0236.
8. N. Graf, J. Gronki, C. Schulz, T. Baritaud, J. Chérel, P. Duret, and J. Lavy: "In-cylinder Combustion Visualization in an Auto-Igniting Engine using Fuel Tracer- and Formaldehyde-LIF Imaging", SAE2001-01-1924.
9. M. Richter, A. Franke, M. Aldén, A. Hultqvist and B. Johansson: "Optical Diagnostics Applied to a Naturally Aspirated Homogeneous Charge Compression Ignition Engine", SAE1999-01-3649.
10. C. Brackmann, J. Nygren, X. Bai, Z. Li, H. Bladh, B. Axelsson, I. Denbratt, L. Koopmans, P.-E. Bengtsson and M. Aldén: "Laser-Induced Fluorescence of Formaldehyde in Combustion using Third-Harmonic Nd:YAG Laser Excitation", submitted to Spectrochimica Acta Part A (2003).
11. T. Metz, X. Bai, F. Ossler, and M. Aldén: "Fluorescence lifetimes of formaldehyde (H<sub>2</sub>CO) in the  $\tilde{A}^1A_2 \rightarrow X^1A_1$  band system at elevated temperatures and pressures", submitted to Spectrochimica Acta Part A (2003).