



LUND UNIVERSITY

Degranulation in macrophages and other leukocytes: regulation by calcium, phosphoinositide 3-kinase, and protein kinase C

Nauc r, Claes

2001

[Link to publication](#)

Citation for published version (APA):

Nauc r, C. (2001). *Degranulation in macrophages and other leukocytes: regulation by calcium, phosphoinositide 3-kinase, and protein kinase C*. [Doctoral Thesis (compilation), Department of Experimental Medical Science]. Claes Nauc r, BMC B11, S-22184 Lund, Sweden,.

Total number of authors:

1

General rights

Unless other specific re-use rights are stated the following general rights apply:

Copyright and moral rights for the publications made accessible in the public portal are retained by the authors and/or other copyright owners and it is a condition of accessing publications that users recognise and abide by the legal requirements associated with these rights.

- Users may download and print one copy of any publication from the public portal for the purpose of private study or research.
- You may not further distribute the material or use it for any profit-making activity or commercial gain
- You may freely distribute the URL identifying the publication in the public portal

Read more about Creative commons licenses: <https://creativecommons.org/licenses/>

Take down policy

If you believe that this document breaches copyright please contact us providing details, and we will remove access to the work immediately and investigate your claim.

LUND UNIVERSITY

PO Box 117
221 00 Lund
+46 46-222 00 00

Från Institutionen för cell och molekylärbiologi
Lunds universitet

Degranulation in Macrophages and other Leukocytes:

Regulation by Calcium, Phosphoinositide 3-kinase,
and Protein kinase C

Akademisk avhandling

som med vederbörligt tillstånd av Medicinska fakulteten
vid Lunds universitet för avläggande av doktorsexamen i
medicinsk vetenskap kommer att offentligen försvaras i GK
salen, BMC, Sölvegatan 19, Lund, torsdagen den 17 januari
2002, kl 10.15

av

Claes Nauclér

Fakultetsopponent:
Professor Karl-Eric Magnusson
Medicinsk mikrobiologi
Institutionen för hälsa och miljö
Hälsouniversitetet, Linköpings universitet

Organization LUND UNIVERSITY Department of Cell and Molecular Biology BMC, B11 221 84 Lund, Sweden		Document name DOCTORAL DISSERTATION	
		Date of issue 2002-01-17	
Author(s) Claes Nauclér		Sponsoring organization	
Title and subtitle DEGRANULATION IN MACROPHAGES AND OTHER LEUKOCYTES: regulation by calcium, phosphoinositide 3-kinase, and protein kinase C			
Abstract Macrophages mediate innate immunity through release of cytokines, eicosanoids, reactive oxygen species as well as through phagocytosis and secretion of lysosomal enzymes. Regulation of lysosomal secretion in macrophages differs in several respects from release of specialized granules in other leukocytes. Lysosomal secretion is not dependent upon cytosolic calcium but is instead triggered by lysosomal alkalization and is modulated by cytosolic pH. Common to secretory responses in most leukocytes, on the other hand, is a regulation by protein kinase C. Immune complexes trigger a localized azurophilic degranulation in neutrophils which is dependent upon protein kinase C. An enrichment of conventional isoforms at the target area of the plasma membrane further implies a role for these kinases in the spatial regulation of degranulation. Lysosomal secretion in macrophages is likewise regulated by protein kinase C. This regulation is also exerted by conventional isoforms but involves both enhancing and repressing signaling pathways. Activation of protein kinase C reduces secretion through inhibition of lysosomal alkalization while at the same time inducing a compensatory enhancement downstream of the lysosomal alkalization. Both pathways are sensitive to depletion of cytosolic calcium and are blocked by down-regulation of conventional isoforms of protein kinase C. The pathway acting on lysosomal pH involves signaling through phosphoinositide 3-kinase. Inhibition of this kinase abrogates translocation of conventional isoforms of protein kinase C to lysosomes.			
Key words: lysosomal secretion, exocytosis, lysosomal pH, neutrophil, proton pump			
Classification system and/or index terms (if any):			
Supplementary bibliographical information:		Language English	
ISSN and key title:		ISBN 91-628-5082-2	
Recipient's notes		Number of pages	Price
		Security classification	

Distribution by (name and address)

I, the undersigned, being the copyright owner of the abstract of the above-mentioned dissertation, hereby grant to all reference sources permission to publish and disseminate the abstract of the above-mentioned dissertation.

Signature

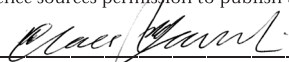

Date

2001-11-28

Till Elisabeth

Claes Nauclér, 2001

ISBN 91-628-5082-2

Printed by Bloms i Lund Tryckeri AB, Lund, Sweden.

Contents

List of papers _____	6
Abbreviations _____	7
Introduction to Macrophages _____	8
Lysosomal secretion _____	9
Ca ²⁺ and regulated secretion in leukocytes _____	18
Neutrophils	
Eosinophils	
Basophils and mast cells	
Platelets	
Cytotoxic T cells and natural killer cells	
Monocytes and macrophages	
Phosphatidylinositol 3-kinase _____	28
Protein kinase C _____	31
Isoforms and expression	
Structure	
Regulation	
Down-regulation	
Inhibitors	
Protein kinase C in exocytosis _____	42
Neutrophils	
Eosinophils	
Basophils and RBL-2H3 cells	
Mast cells	
Platelets	
Cytotoxic T cells and natural killer cells	
Monocytes and macrophages	
Paper I _____	51
Paper II _____	52
Paper III _____	54
Paper IV _____	56
Paper V _____	57
Concluding remarks _____	59
Popularized summary in swedish _____	63
Acknowledgements _____	65
References _____	66

List of papers

This thesis is based on the following papers, which will be referred to in the text by their Roman numeral.

- I. Dexamethasone lowers cytosolic pH in macrophages by altering alkalizing pH-regulatory mechanisms
Claes Nauc ler, Roger Sundler and Hans Tapper
J. Leukoc. Biol. (2000) **67**, 876-884
- II. Dexamethasone downregulates lysosomal secretion in mouse macrophages: Involvement of signaling through protein kinase C
Karin Gewert, Hans Tapper, Claes Nauc ler and Roger Sundler
J. Inflamm. (1995/1996) **47**, 115-125
- III. Signaling to localized degranulation in neutrophils adherent to immune complexes
Claes Nauc ler, Sergio Grinstein, Roger Sundler and Hans Tapper
In press, J. Leukoc. Biol.
- IV. Regulation of lysosomal pH in macrophages via phosphatidylinositol 3-kinase and protein kinase C
Claes Nauc ler and Roger Sundler
submitted for publication
- V. Modulation of lysosomal secretion by protein kinase C in mouse macrophages
Claes Nauc ler and Roger Sundler
submitted for publication

Abbreviations

4 α -PDD	4 α -phorbol 12,13-didecanoate
BAPTA	1,2-bis(O-aminophenyl)-ethane-ethane-N,N,N',N'-tetraacetic acid
BLT	benzyloxycarbonyl-L-lysine thiobenzyl ester-esterase
CaM	calmodulin
cPLA ₂	cytosolic phospholipase A ₂
CTL	cytotoxic T lymphocytes
DAG	1,2-diacylglycerol
DIDS	4,4'-diisothiocyanatostilbene-2,2'-disulfonic acid
ECP	eosinophil cationic protein
EDTA	ethylenediaminetetraacetic acid
EGTA	ethylene glycol bis(beta-aminoethyl ether)-N,N,N',N'-tetraacetic acid
FMLP	N-formyl-methionyl-leucyl-phenylalanine
GFP	green fluorescent protein
GTP γ S	guanosine-5'-O-(3-thiotriphosphate)
LDH	lactate dehydrogenase
LTB ₄	leukotriene B ₄
MARCKS	myristoylated alanine-rich protein kinase C substrate
MPO	myeloperoxidase
NK-cells	natural killer cells
NSF	N-ethylmaleimide sensitive factor
OAG	1-oleoyl-2-actetyl-glycerol
PAF	platelet activating factor
PDBu	phorbol 12,13-dibutyrate
PDK1	phosphoinositide-dependent kinase-1
PH	pleckstrin homology
PI3K	phosphatidylinositol 3-kinase
PKA	cAMP-dependent protein kinase
PKB	protein kinase B
PKC	protein kinase C
PKG	cGMP-dependent kinase
PLC	phospholipase C
PMA	phorbol myristate acetate
PS	phosphatidylserine
RACK	receptor for activated C kinase
SNAP	small N-ethylmaleimide sensitive factor attachment protein
SNARE	SNAP receptor
TCR	T-cell receptor
VAMP	vesicle associated membrane protein

Introduction to macrophages

Already in the late 19th century Metchnikoff identified macrophages as inflammatory phagocytic cells. The presence of these cells in all studied animals has now been acknowledged (Seljelid and Eskeland 1993), and they are known to play an important role in innate immunity (Gallin, Goldstein et al. 1992). Monocytes derive from pluripotent stem cells in the bone marrow and are continuously released into the blood stream. Circulating monocytes later leave the blood stream migrating through the vessel endothelium to differentiate into various forms of resident tissue macrophages. Release of monocytes from the bone marrow and subsequent migration into inflammatory lesions can be significantly increased during acute stages of inflammation (Van Furth, Diesselhoff-den Dulk et al. 1973). Macrophages reside in virtually all tissues. Examples are alveolar macrophages in the lung, Langerhans cells in the dermis, microglial cells in the brain, synovial macrophages in the joints, peritoneal macrophages in the peritoneal cavity and Kupffer cells in the liver (Gordon, Keshav et al. 1988). Kupffer cells are thought to play a major role in the removal and destruction of foreign particles in the portal blood (Crofton, Diesselhoff-den Dulk et al. 1978; Wisse and Knook 1979). Macrophages continuously partake in tissue surveillance and repair e.g. through phagocytosis of apoptotic cells (Platt, da Silva et al. 1998) and degradation of extracellular matrix. Macrophages also present antigens to T-lymphocytes (Asherson and Colizzi 1991) through expression of class II MHC molecules (Roitt 1991; Ramachandra, Song et al. 1999). Macrophages release a wide range of products with which they can influence their environment. They can, thus, both initiate inflammatory responses and influence the adaptive immune system through production of eicosanoids and cytokines. As a first line of defense against infection, macrophages kill microbes through phagocytosis (Rutherford, Witsell et al. 1993), lysosomal secretion, production of oxygen radicals, and production of nitric oxide (Hibbs, Taintor et al. 1987). Macrophages are the predominant cells-type found at sites of chronic inflammatory lesions, and their arsenal of secreted cytokines and hydrolytic lysosomal enzymes possibly plays a detrimental role in the pathology of, for instance, autoimmune diseases. A correlation has been found between

the ability of certain stimuli to trigger release of lysosomal hydrolases *in vitro* and their capacity to induce inflammation *in vivo* (Schorlemmer, Davies et al. 1977). It has therefore been suggested that macrophage lysosomal secretion plays an important role in promoting chronic inflammation (Davies and Allison 1976). Also, macrophages are found in the granulation tissue, which overlaps articular cartilage in rheumatoid arthritis (Kobayashi and Ziff 1975), and a substantial number of macrophages can be found in synovial fluid from patients suffering from this disease (Krane, Conca et al. 1990).

Lysosomal secretion

Secretion of granular content through degranulation can occur either constitutively or in a regulated fashion. Constitutive secretion is a continuous process where newly synthesized material from the endoplasmic reticulum and Golgi is packaged in vesicles, transported to the cell surface and released through fusion with the plasma membrane. Constitutive secretion is dependent on protein synthesis, and an example in macrophages is release of the antibacterial protein lysozyme (Gordon, Todd et al. 1974). Regulated secretion, on the other hand, is a process common to specialized cell-types where contents destined for exocytosis is packaged in membranous compartments while waiting to be released upon cellular activation. Some leukocytes have specialized secretory granules which can be rapidly mobilized during cellular activation. No such granules have been identified in macrophages yet. Instead, these cells respond to exocytotic stimuli with release of lysosomal contents. Although the bulk of lysosomal enzymes is found in what is classically regarded as the lysosomal compartment, these enzymes can also be found in endosomes. A recent analysis of endocytic compartments from macrophages (J774 cell line) revealed a selective enrichment of the lysosomal proteases cathepsin H and S in early and late endosomes, respectively (Claus, Jahraus et al. 1998). Some evidence was also found of the existence of subgroups among lysosomes as this compartment only partly could be mobilized by elevation of lysosomal pH by means of treatment with bafilomycin A₁, an inhibitor of the vacuolar proton pump. Both subgroups were identified as lysosomes but with somewhat different enzyme content. The role of lysosomal

pH in lysosomal secretion is further discussed below. For the sake of simplicity, however, the lysosomal compartment is often defined as the most distal compartment in the endocytic pathway (Storrie 1988; Kornfeld and Mellman 1989). Notably, there is a resemblance in terms of contents between lysosomes and certain specialized secretory granules in other leukocytes. Such granules are often viewed upon as specialized secretory lysosomes. An example of this is the azurophilic granule in neutrophils which contain many of the enzymes found in common lysosomes (Borregaard, Lollike et al. 1993) but lack the lysosomal marker lamp-1 in the membrane (Dahlgren, Carlsson et al. 1995; Cieutat, Lobel et al. 1998). It has recently been found that lysosomal secretion may be common to a broader spectrum of cells (Andrews 2000). Lysosomal secretion can for instance be triggered by Ca^{2+} -influx in fibroblasts and is thought to be a process involved in resealing after injury to the plasma membrane (Rodriguez, Webster et al. 1997). The lysosomal compartment has an acidic interior maintained through active inward transportation of protons from the cytosol by a vacuolar proton pump (Schneider 1981). pH in the lysosomal compartment is typically kept between 4.5 and 5 (Ohkuma and Poole 1978). Accordingly, most enzymes found in lysosomes have pH-optima in the acidic range. This is thought to convey effective degradation of materials inside the lysosomes while preventing self-destruction in case enzymes should escape to the more alkaline cytosol. It has, however, recently become apparent that lysosomes also harbor hydrolytic enzymes with pH-optima in the neutral range (Butor, Griffiths et al. 1995; Bank and Ansorge 2001). This further underlines the significance of lysosomes as a secretory compartment in addition to functions such as degradation of materials accumulated through endocytosis and autophagy. The mechanism of lysosomal biogenesis has been under debate for some time, and it remains unclear whether endocytosed material fuses directly with vesicles from the Golgi containing hydrolytic enzymes to form lysosomes, or if endocytosed and phagocytosed material sequentially fuse with early and late endosomes in order to reach the lysosomes (Desjardins 1995). Low amounts of lysosomal enzymes are constitutively secreted from macrophages (Schnyder and Baggiolini 1978) but a bulk secretion is triggered, for instance, by contact with particulate, phagocytosable stimuli such as zymosan (Schorlemmer, Davies et al. 1977; Dean,

Hylton et al. 1979a). Zymosan is a cell wall preparation from *Saccharomyces cerevisiae* containing mannan- and glucan-chains which are recognized by plasma membrane receptors in macrophages (Di Carlo and Fiore 1957; Bogwald, Johnson et al. 1984; Tapper and Sundler 1995b). Such regulated secretion of lysosomal enzymes is not dependent upon simultaneous protein synthesis (Davies and Bonney 1980; McCarthy, Musson et al. 1982). Lysosomal secretion can further be triggered by pathological agents such as various bacteria, immune complexes, asbestos fibers, coal particles, mold and dental plaques (Pestel, Joseph et al. 1979; Davies and Bonney 1980) but is not dependent upon phagocytosis *per se* (Schorlemmer, Davies et al. 1977; Dean, Hylton et al. 1979a; Tapper and Sundler 1995b). Secretion can accordingly be elicited by non-phagocytosable stimuli, as shown by stimulation with IgG-coated Sepharose beads of much larger size than the macrophage itself (Dean, Hylton et al. 1979b). Lysosomal secretion can also be triggered by soluble stimuli, directly affecting lysosomal pH, such as primary amines, ionophores and inhibitors of the proton pump (Riches and Stanworth 1980; Takano, Imai et al. 1984; Tapper and Sundler 1990; Tapper and Sundler 1995a). It should be noted that monocytes, monocytic and macrophage cell lines, as well as freshly isolated macrophages, mobilize lysosomal enzymes less readily upon activation than what is the case in cultured macrophages (Tapper and Sundler 1995c, and personal communications). Furthermore, mouse peritoneal macrophages, elicited by intra-peritoneal injections of thioglycollate, are more responsive to certain stimuli compared to resident macrophages in terms of lysosomal enzyme release (Bonney, Wightman et al. 1980). In a simplified model of regulated secretion one would anticipate at least three common steps (Figure 1). Firstly, the cell responds to its environment with activation of signaling cascades which in macrophages leads to a crucial alkalization of lysosomes. This, in turn, triggers the second step in which the secretory compartment is transported to the vicinity of the plasma membrane. This step precedes the first step in some cell types where pre-docked secretory compartments already await the triggering signal at its target location. Finally, in the third step, the secretory compartment fuses with the target membrane exposing its lumen to the outside of the cell.

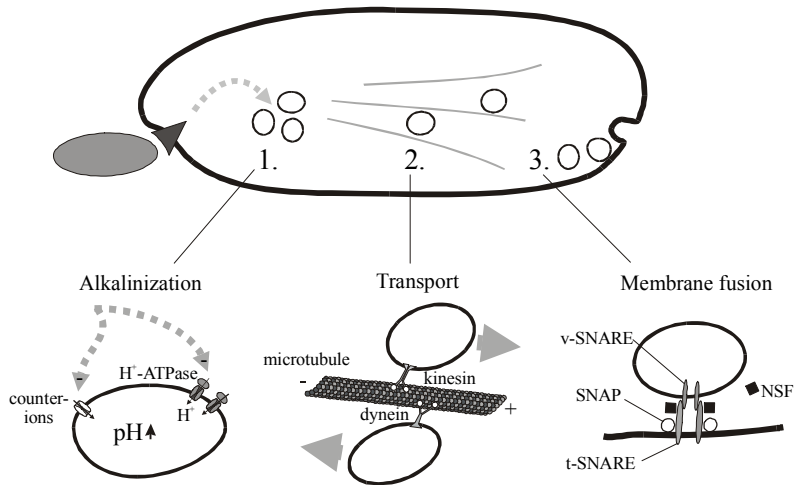

Figure 1. Outline of the major steps in zymosan-induced lysosomal secretion in macrophages.

Macrophages harbor several receptors that are able to activate signaling pathways leading to exocytosis. For instance, secretion may be triggered by receptors for IgG (Cardella, Davies et al. 1974), complement components (Schorlemmer and Allison 1977) or carbohydrate structures (Bogwald, Johnson et al. 1984). It is not known whether certain common signaling pathways required for secretion are activated by all of these receptors, or if secretion may be triggered by separate sets of signaling pathways specific to each receptor. It can be noted, however, that the involvement of certain signaling pathways seems to be common to a broad variety of cell types. The mechanism of Ca^{2+} -induced exocytosis, for instance, has been thoroughly studied in neuronal cells as well as pancreatic β -cells (Berggren and Larsson 1994; Burgoyne and Morgan 1995; Henquin, Jonas et al. 1998). In such excitable cells, a rise in cytosolic Ca^{2+} is achieved through plasma membrane depolarization, which in turn leads to opening of voltage-sensitive Ca^{2+} -channels, and thus influx of extracellular Ca^{2+} . The role of protein kinase C in excitatory cell secretion has also been extensively reviewed (Zimmermann 1990; Liu 1997; Hille, Billiard et al. 1999; Turner, Burgoyne et al. 1999). Activation of protein kinase C (PKC) by phorbol esters triggers a Ca^{2+} -independent degranulation in, for example, pituitary gonadotrope

cells (Billiard, Koh et al. 1997; Chang, Graeter et al. 1986). Secretion in these cells is also sensitive to down-regulation of PKC and is inhibited by staurosporine, which is a broad-spectrum kinase inhibitor (Dan-Cohen and Naor 1990). A modulating role for PKC in excitatory cell degranulation has also been suggested. For instance an increased probability for vesicle release (Malenka, Madison et al. 1986; Segal 1989) as well as an increase in the pool of readily releasable vesicles and refill velocity (Stevens and Sullivan 1998) has been noted in synaptic cells upon activation of PKC by phorbol esters. The roles of Ca^{2+} and PKC in leukocyte degranulation are discussed separately below.

Macrophages differ from other secretory cells in the first triggering step of exocytosis. It has been found that agents which increase lysosomal pH also induce lysosomal secretion. Such secretion is triggered, for instance, by weak bases including primary amines, quinine and chloroquine (Riches and Stanworth 1982) which accumulate in acidic compartments causing a slow alkalization (Ohkuma and Poole 1981; Poole and Ohkuma 1981). Lysosomal pH can also be disturbed by ionophores such as monensin, which confers free passage of sodium and protons over membranes, or nigericin, which allows passage of potassium and protons. These agents cause alkalization of lysosomes (Ohkuma and Poole 1978) and have also been found to trigger lysosomal secretion in macrophages (Takano, Imai et al. 1984; Tapper and Sundler 1990). A role for the actual alkalization in triggering of secretion is further supported by the finding that bafilomycin A_1 , which causes lysosomal alkalization by direct inhibition of the acidifying vacuolar proton pump (Dröse, Bindsell et al. 1993; Tapper and Sundler 1995a), also results in lysosomal secretion in macrophages (Tapper and Sundler 1995a). Lysosomal alkalization can also, as mentioned, be triggered by particulate stimuli in macrophages. It has been shown that stimulation of macrophages with zymosan induces a slow progressive rise in lysosomal pH (Tapper and Sundler 1995c). This alkalization is not a result of phagocytosis and subsequent phagolysosomal fusion which was shown through blockage of phagocytosis by pretreatment with cytochalasin B. Although macrophages readily ingest latex beads, this stimulus neither affects lysosomal pH, nor triggers secretion. These findings imply that receptor engagement is required for induction of

lysosomal alkalization by particulate stimuli in macrophages. Zymosan and monensin, in contrast to agents such as methylamine and monensin which act solely by affecting lysosomal pH, are in combination additive stimuli for macrophages lysosomal secretion, indicating other pathways besides lysosomal alkalization in zymosan-induced secretion (Riches and Stanworth 1982). It is presently not clear if lysosomal alkalization is a secretion-triggering step induced also by other particulate stimuli, such as bacteria. A role for lysosomal/granular pH has also been considered in secretory responses in other cell types. It is for instance not clear whether neutrophils degranulate in response to granular alkalization. While it has been reported that no β -glucuronidase (a marker for azurophilic granules) is released from monensin-stimulated neutrophils (Korchak and Weissmann 1980), such secretion has been found by others in both rabbit (Di Virgilio and Gomperts 1983) and human neutrophils (Fittschen and Henson 1994). As opposed to macrophages, neutrophil degranulation is not triggered by stimulation with weak bases. On the contrary, it has been found that alkalization of granules inhibited degranulation induced by stimuli such as phorbol myristate acetate (PMA) and A23187 (Klempner and Styrts 1983). Thus, the relation between granular pH and secretion in neutrophils still remains to be established. Degranulation in response to monensin has also been observed in RBL-2H3 cells, where an increase in cytosolic Ca^{2+} through Ca^{2+} -influx pathways was suggested as the triggering mechanism (Stump, Oliver et al. 1987). In human platelets, weak bases, such as primary amines and chloroquine, exert an enhancing effect on thrombin-induced secretion of lysosomal contents (Van Oost, Smith et al. 1985).

Maintenance of a firmly regulated cytosolic pH is a crucial process in all cells (Madshus 1988). Regulation of cytosolic pH is especially important in leukocytes operating in inflammatory environments where the exudate pH tends to be low (Lardner 2001). The level of cytosolic pH in macrophages is set by counteracting alkalizing and acidifying mechanisms. Macrophages make use of bicarbonate for regulation of cytosolic pH by means of an alkalizing Na^+ -dependent $\text{Cl}^-/\text{HCO}_3^-$ -exchanger and an acidifying Na^+ -independent $\text{Cl}^-/\text{HCO}_3^-$ -exchanger (Tapper and Sundler 1992a). These mechanisms, together

with an alkalinizing H^+ -ATPase (Tapper and Sundler 1992b), operate in the physiological range of cytosolic pH and determine the level of cytosolic pH in resting macrophages. These cells also express a Na^+/H^+ -exchanger, but this mechanism is inactive in quiescent macrophages, operating only after larger acidifications of the cytosol (Tapper and Sundler 1992b; Bidani, Brown et al. 1994). pH is an important determinant of the three-dimensional structure of proteins due to the presence of amino acid residues, serving as either donors or acceptors of protons. The side chains of amino acids, such as histidine, contain ionizable groups with pK values in a near-physiological range. Apart from being an important regulator of metabolic pathways in eukaryotic cells, another role for cytosolic pH has also been found in regulation of some highly specialized inflammatory cell functions. A permissive pH is for instance required for macrophage functions, such as phagocytosis (Bidani and Heming 1995), superoxide production (Swallow, Grinstein et al. 1990; Bidani and Heming 1995), and release of cytokines (Bidani and Heming 1995). Modulating effects of cytosolic pH have further been observed on transactivation of transcription factors (Murguía, De Vries et al. 1995; Conboy, Manoli et al. 1999) and propensity of cells to undergo apoptosis (Gottlieb, Giesing et al. 1995). Still another role for cytosolic pH has been found in the modulation of lysosomal secretion in macrophages (Tapper and Sundler 1990). Lysosomal secretion is inhibited at low cytosolic pH-levels, while alkalinization of the cytosol has an enhancing effect on secretion. The molecular mechanism for modulation of lysosomal secretion by cytosolic pH has to date not been clarified, but a role for the gradient formed between cytosolic pH and the triggering lysosomal pH has been suggested (Sundler 1997). Also, others have found that regulation of cytosolic pH is of importance in cellular membrane trafficking. Manipulation of cytosolic pH to levels below 6.8 reversibly inhibits both endocytic and exocytotic membrane transportation in fibroblasts (Cosson, de Curtis et al. 1989). The abrogation of vesicular traffic is preceded by a redistribution of lysosomes and endosomes toward the periphery of the cells. Similar observations have been made in neuronal and epithelial cells, where these movements are dependent on microtubules (Parton, Dotti et al. 1991) and mediated by kinesins (Hollenbeck and Swanson 1990; Swanson, Locke et al. 1992).

Organelles in eukaryotic cells are known to be transported in specific directions along microtubules. Such movements are mediated by motor proteins containing motor, cargo-binding, and regulatory components. Myosins mediate movement along actin filaments, while kinesins and dyneins mediate movement along microtubules (Vale and Fletterick 1997). Most kinesins transport cargo toward the plus-end while dyneins mediate transports toward the minus-end of microtubules. Kinesins and dyneins have been shown to mediate macrophage phagosome movement in vitro along microtubules in centrifugal and centripetal directions, respectively (Blocker, Severin et al. 1996; Blocker, Severin et al. 1997). It has been established that lysosomes translocate along microtubules, and lysosomes have also been found to co-localize with dyneins (Lin and Collins 1992). A role for actin filaments in exocytotic events has also been thoroughly discussed. It has been suggested that cross-linked actin filaments constituting a network beneath the plasma membrane can act as a barrier to exocytotic vesicles. This view is supported by the finding that exocytosis, in numerous cell-types, is facilitated by disruption of actin filaments or inhibition of filament polymerization (Aunis and Bader 1988; Muallem, Kwiatkowska et al. 1995; Vitale, Seward et al. 1995). Disruption of actin filaments has in some cell-types further proved to constitute a sufficient trigger for exocytosis (Muallem, Kwiatkowska et al. 1995).

When translocation of lysosomes toward a target area of the plasma membrane has been triggered, docking and fusion are the final events mediating release of lysosomal content to the cell exterior. Release of vesicular contents requires docking, meaning recognition and close apposition between donor and acceptor membranes before fusion can occur. Docking and fusion is mediated by a set of proteins designated SNAP receptors (SNAREs), which were discovered in synaptic vesicles and presynaptic plasma membranes. The SNARE hypothesis was first presented by Rothman and colleagues (Rothman and Orci 1992; Söllner, Bennet et al. 1993). SNAREs are family members of highly conserved proteins residing on vesicles (v-SNARE) and target membranes (t-SNARE). Both v- and t-SNAREs seem to be required on adjacent membranes for membrane docking to occur (Nichols, Ungermann et al. 1997; Weber, Zemelman et al. 1998). Direct evidence for the necessity of SNAREs in synaptic release comes from

experiments using toxins from *Clostridium botulinum* and *Clostridium tetani*, which through endoproteolytic cleavage, target and destroy v-SNAREs, including synaptobrevin or vesicle associated membrane protein (VAMP), and t-SNAREs, including syntaxins and synaptosome-associated proteins (Blasi, Binz et al. 1994; Montecucco and Schiavo 1995). SNAREs are important for, but not the only determinants of, fusion target specificity. In agreement with the multiple isoforms identified to date, specificity of vesicle trafficking seems to be ensured by the presence of unique sets of SNAREs in different membrane compartments (Söllner, Bennet et al. 1993; Bock and Scheller 1997). After recognition between v- and t-SNAREs, formation of the fusion complex is completed through binding of the soluble ATPase NSF (N-ethylmaleimide sensitive factor) and SNAPs (small N-ethylmaleimide sensitive factor attachment proteins) which promote fusion and subsequent dissociation of the complex. Sensitivity to SNARE-specific toxins and, hence, existence of SNARE fusion complexes has also been identified in a wide array of non-neuronal cell types, including macrophages (Ho and Klempner 1985; Pitzurra, Marconi et al. 1989; Pitzurra, Blasi et al. 1993). Several SNAREs have now been identified in both neutrophils and macrophages (Brumell, Volchuk et al. 1995; Nabokina, Egea et al. 1997; Hackam, Rotstein et al. 1996). The formation of SNARE complexes can in turn be regulated by Rab proteins *in vivo* (Lian, Stone et al. 1994; Sogaard, Tani et al. 1994; Lupashin and Waters 1997). The roles of Ca^{2+} and PKC in regulated secretion in leukocytes are discussed below, but it can be mentioned that both Ca^{2+} and phosphorylation events are implicated in the regulation of several SNAREs. It has for instance been shown that activation of PKC leads to phosphorylation of SNAP-25 as well as Munc-18 and that synaptotagmins can act as substrates for PKC (Fujita, Sasaki et al. 1996; Shimazaki, Nishiki et al. 1996; Hilfiker, Pieribone et al. 1999). Synaptotagmin 1, which contains a C2 domain, also found in cytosolic phospholipase A_2 (cPLA₂) and Ca^{2+} -sensitive isoforms of PKC (Perin, Fried et al. 1990), has been suggested as a potential Ca^{2+} -sensor in regulated secretion (Perin, Fried et al. 1990; Sudhof and Rizo 1996). Synaptotagmin 1 knockout mice show impaired Ca^{2+} -dependent vesicle exocytosis in neurons (Sudhof and Rizo 1996).

Table 1. Secretory compartments in leukocytes

Cell-type	compartment	example of contents	ref.
Neutrophils	azurophilic granules	MPO, elastase, defensins	(1)
	specific granules	lysozyme, lactoferrin	
	gelatinase granules	gelatinase	
	secretory vesicles	ALP	
Eosinophils	primary granules	Charcot-Leyden crystal proteins	(2, 3)
	specific granules	MBP, ECP, EPO	
	small-type granules	arylsulphatase	
	secretory vesicles	albumin	
Basophils & Mast cells	secretory granules	histamine, serotonin, heparin etc	(4)
	lysosomes	hydrolases	
Platelets	dense core granules	serotonin, ADP, Ca ²⁺	(5, 6)
	alpha granules	vWF, PDGF, fibrinogen	
	lysosomes	hydrolases etc	
CTL & NK-cells	lytic granules	perforin, hydrolases	(7)
Monocytes & Macrophages	lysosomes	hydrolases	(8, 9)

(1) Borregaard, Lollike et al. 1993 (2) Gleich, Adolphson et al. 1992 (3) Egesten, Calafat et al. 2001 (4) Siraganian 1992 (5) Weksler 1992 (6) White 1994 (7) Page, Darmon et al. 1998 (8) Dell'Angelica, Mullins et al. 2000 (9) Henson, Henson et al. 1992

Ca²⁺ and regulated secretion in leukocytes

There is a general understanding that an increase in cytosolic Ca²⁺ is necessary as well as sufficient for the initiation of secretion in most excitable cells. Mechanisms involved in elevation of Ca²⁺ and potential Ca²⁺-sensitive components of the exocytotic machineries have been reviewed in for instance neurons (Burgoyne and Morgan 1995; Meir, Ginsburg et al. 1999; Sudhof 2000), neuroendocrine cells (Cheek and Barry 1993) and pancreatic β -cells (Henquin 2000; Satin 2000). Even though addressed in numerous studies of leukocytes, the role of cytosolic Ca²⁺ in the degranulation response of these cells and other non-excitable cells is less clear. A compilation of results from such studies is presented below.

Neutrophils

Elevation of cytosolic Ca^{2+} is a common feature to most physiological stimuli capable of inducing neutrophil degranulation. Neutrophils contain four subsets of granules classified by contents (Table 1). Specific granules, gelatinase granules and secretory vesicles contain enzymes and receptors involved in extravasation and migration. These granules appear late in neutrophil maturation and are the most readily mobilized granules in response to chemotactic stimuli and elevation of cytosolic Ca^{2+} (Borregaard, Lollike et al. 1993; Sengeløv, Kjeldsen et al. 1993). Azurophilic granules, on the other hand, appear early in neutrophil maturation and are less readily released in response to Ca^{2+} . Azurophilic granules resemble lysosomes in some aspects and contain acidic hydrolases, myeloperoxidase (MPO), defensins and lysozyme implying bactericidal functions (Borregaard, Lollike et al. 1993). The differential requirement for cytosolic Ca^{2+} among neutrophil granules has been described, showing that little release of myeloperoxidase occurs at concentrations of cytosolic Ca^{2+} below 100 μM , whereas secondary (specific), and tertiary (gelatinase) granules are released at 1.5-5 μM Ca^{2+} in patch clamped neutrophils with micro-perfusion of Ca^{2+} -containing buffers (Nüsse, Serrander et al. 1998). Exocytosis of primary (azurophilic) granules thus resemble exocytosis in certain neuronal cell types (retinal bipolar cells) with a very low Ca^{2+} -sensitivity requiring concentrations of Ca^{2+} exceeding 100 μM for efficient exocytosis. Secondary granules, on the other hand, show a much higher affinity for Ca^{2+} resembling that found in pancreatic β -cells (Heidelberger and Matthews 1994; Proks, Eliasson et al. 1996; Nüsse, Serrander et al. 1997). A similar sensitivity to cytosolic Ca^{2+} (between 0.3 and 3 μM) has been shown in neutrophils where Ca^{2+} was clamped, either using ionomycin in combination with calibrated Ca^{2+} -containing buffer, or by Sendai virus permeabilization (Lew, Monod et al. 1986; Barrowman, Cockcroft et al. 1987; Borregaard, Lollike et al. 1993). A higher concentration of Ca^{2+} was required in neutrophils permeabilized with digitonin (10-40 μM) (Smolen, Stoehr et al. 1987). Interestingly, elevation of cytosolic Ca^{2+} can be dissociated from degranulation. Ca^{2+} -influx induced by physiological stimuli can be mimicked by the agent thapsigargin, which inhibits re-uptake of Ca^{2+} to intracellular Ca^{2+} -stores. Depletion of Ca^{2+} -stores

leads to influx of Ca^{2+} through channels across the plasma membrane triggered by hitherto unknown signaling pathways. Surprisingly, it has been noted that even though levels of cytosolic Ca^{2+} comparable to those reached in permeabilized cells are accomplished through influx triggered by depletion of Ca^{2+} -stores, such treatment does not trigger degranulation (Nüsse, Serrander et al. 1997). Physiological stimuli often activate several signaling pathways in parallel to elevation of cytosolic Ca^{2+} , and such activation tends to lower the concentration of Ca^{2+} required for degranulation. Treatment of neutrophils with the chemotactic peptide N-formyl-methionyl-leucyl-phenylalanine (FMLP) triggers a concentration and time-dependent release of azurophilic granule contents (Smith, Wierenga et al. 1980). Such treatment causes an elevation of cytosolic Ca^{2+} through sequential opening of internal Ca^{2+} -stores followed by influx through Ca^{2+} -channels. It can be noted that azurophilic degranulation triggered by the Ca^{2+} -ionophore A23187 requires one magnitude higher Ca^{2+} -concentration to elicit a similar response (Shaw, Brodersen et al. 1982; Di Virgilio, Lew et al. 1984). This implies involvement of additional signaling pathways in receptor-mediated degranulation but might also reflect the circumstance that high local concentrations of Ca^{2+} near the inner face of the plasma membrane can be foreseen when monitoring cytosolic Ca^{2+} using traditional probes (Davies and Hallett 1998). Results from several studies indicate that there is no absolute requirement for elevation of cytosolic Ca^{2+} in neutrophil degranulation. Neutrophils treated with immune complexes respond with Fc-receptor-mediated elevation of cytosolic Ca^{2+} followed by azurophilic degranulation. Part of this degranulation is insensitive to Ca^{2+} and proceeds in cells loaded with the Ca^{2+} -chelator 1,2-bis(O-aminophenyl)-ethane-ethane-N,N,N',N'-tetraacetic acid (BAPTA) (Seetoo, Schonhorn et al. 1997). Furthermore, treatment of neutrophils with PMA alone can triggers azurophilic degranulation. This direct activation of protein kinase C does not lead to elevation of cytosolic Ca^{2+} and the exocytotic response proceeds also when Ca^{2+} is modulated to levels 10-20 times lower than that found in resting cells (Di Virgilio, Lew et al. 1984; Mahomed and Anderson 2000).

Eosinophils

Eosinophil degranulation has been studied using stimuli such as platelet activating factor (PAF), A23187, non-hydrolyzable GTP-analogues, opsonized zymosan, IgA-coated beads, and PMA (Kroegel, Yukawa et al. 1989a; Kato, Abraham et al. 1995). It should be noted, however, that A23187-induced release of granular contents in eosinophils, and lysosomal enzymes in macrophages, in some cases has been ascribed to loss of cell integrity and leakage (Fukuda, Ackerman et al. 1985; Tapper and Sundler 1995c). Stimulation of eosinophils by PAF leads to production of inositol 1,4,5-trisphosphate and release of Ca^{2+} from internal stores (Kroegel, Chilvers et al. 1991). This is followed by a sustained elevation of cytosolic Ca^{2+} , which is dependent upon the presence of extracellular Ca^{2+} (Oshiro, Kakuta et al. 2000). Unlike PAF-induced eosinophil production of O_2^- , the exocytotic response is dependent upon influx of Ca^{2+} and inhibited by ethylene glycol bis(beta-aminoethyl ether)-N,N,N',N'-tetraacetic acid (EGTA) (Kroegel, Pleass et al. 1989; Kroegel, Yukawa et al. 1989b). Degranulation induced by engagement of receptors for IgA and IgG is dependent upon a pertussis toxin-sensitive turnover of inositol phosphates (Kita, Kato et al. 1994). In permeabilized eosinophils, degranulation can be induced by the non-hydrolyzable guanosine-5'-O-(3-thiotriphosphate) ($\text{GTP}\gamma\text{S}$) alone (Aizawa, Kakuta et al. 1992; Larbi and Gomperts 1997). This response is however dependent upon the presence of ATP (Larbi and Gomperts 1997) and is modulated by the availability of cytosolic Ca^{2+} (Nüsse, Lindau et al. 1990; Cromwell, Bennett et al. 1991). Like in neutrophils, degranulation in eosinophils can be triggered by PMA alone (Kroegel, Yukawa et al. 1988). Involvement of PKC in eosinophil degranulation is discussed below.

Basophils and mast cells

As in other leukocytes, there is no firm consensus on the requirement for and the participation of cytosolic Ca^{2+} in regulated secretion in basophils and mast cells. Much of the information available on the regulation of secretion in these cells, originates from studies using the RBL-2H3 mucosal mast cell-line as a model. The physiological stimulus for exocytosis in mast cells is cross-linking of high affinity

receptors for IgE (Metzger 1992). Degranulation can also be triggered *in vitro* by the ionophores A23187 and nigericin or agents that bypass receptor activation such as compound 40/80 and mastoparan (Blackwell, Bonser et al. 1985; Heiman and Crews 1985; Bronner, Valle et al. 1986; Chakravarty, Kjeldsen et al. 1990; Alfonso, Cabado et al. 2000). Mastoparan is a substance extracted from wasp venom, which accelerates guanine nucleotide exchange and GTPase activity of GTP-binding proteins (Wheeler-Jones, Saermark et al. 1992). The role for Ca^{2+} and G-proteins as regulators of degranulation has been thoroughly studied in permeabilized RBL-2H3 cells. Generally, degranulation in permeabilized mast cells requires presence of both Ca^{2+} as well as $\text{GTP}\gamma\text{S}$. As cytosolic proteins escape in a time-dependent manner during permeabilization, the cells become "run-down" and less responsive in terms of degranulation. Interestingly, this state is partly reversed in mast cells by addition of exogenous activated small G-proteins, such as Cdc42 or Rac. An *in vitro* interaction has also been found between Cdc42 and $\text{PLC}\gamma 1$, suggesting an upstream role for small G-proteins in formation of inositol 1,4,5-trisphosphate (Hong-Geller and Cerione 2000). The need for both Ca^{2+} and $\text{GTP}\gamma\text{S}$ to be present for release of histamine and lysosomal enzymes has been shown in RBL-2H3 and mast cells permeabilized with digitonin and streptolysin-O (Cockcroft, Howell et al. 1987; Churcher, Kramer et al. 1990; Koopmann and Jackson 1990; Pinxteren, O'Sullivan et al. 1998). Others have shown that exocytosis can be triggered by elevation of cytosolic Ca^{2+} alone in such cells, and they suggest that these differences between results originate from deviating use of buffers during permeabilization (Howell, Cockcroft et al. 1987; Lillie and Gomperts 1992). In accordance with the latter findings, degranulation in non-permeabilized mast cells can be evoked by solely elevating cytosolic Ca^{2+} through ionophores such as A23187 (Blackwell, Bonser et al. 1985; Heiman and Crews 1985; Bronner, Valle et al. 1986; Chakravarty, Kjeldsen et al. 1990). It should be noted that this treatment results in a stable elevation of cytosolic Ca^{2+} , which does not mimic the oscillations and irregular spikes of Ca^{2+} seen in cells exposed to physiological antigenic stimuli (Narenjkar, Marsh et al. 1999). Hence, such oscillations of Ca^{2+} do not seem to be required for induction of degranulation. It is currently not known

whether the oscillations carry coded information of relevance for cell physiology. On the other hand, the view of cytosolic Ca^{2+} as a prerequisite for mast cell degranulation is challenged by the finding that an exocytotic response can be elicited by antigen-stimulation without a concomitant rise of cytosolic Ca^{2+} (Pecht and Corcia 1987).

Platelets

Platelets are activated in response to vessel injury or exposure to various agents, leading to changes of shape including formation of pseudopodia, aggregation, and secretion of substances through degranulation (Weksler 1992). In electro-permeabilized platelets, elevation of cytosolic Ca^{2+} to a pCa^{2+} of 5.5 is sufficient for release of both dense granules (serotonin) as well as α -granules (β -thromboglobulin). Addition of $\text{GTP}\gamma\text{S}$ or activation of PKC causes only a minor enhancement of this secretion, but lowers the requirement for Ca^{2+} for maximal response (Coorssen, Davidson et al. 1990). In streptolysine-O-permeabilized platelets, EC_{50} -values for Ca^{2+} -induced release of dense core granule and α -granule contents are 5 and 10 μM , respectively (Padfield, Panesar et al. 1996). Activation of PKC by PMA in the nominal absence of Ca^{2+} causes only a minor release of dense core granule contents, whereas addition of $\text{GTP}\gamma\text{S}$ also causes release of alpha granule contents (Coorssen, Davidson et al. 1990). Furthermore, it is reported by others that PMA stimulates release of dense granule contents, as opposed to $\text{GTP}\gamma\text{S}$, when cytosolic Ca^{2+} is lowered to pCa^{2+} -values greater than 9 (Sloan and Haslam 1997), and that PMA induces secretion in non-permeabilized platelets without affecting ground-level cytosolic Ca^{2+} as measured with quin2 (Poll and Westwick 1986). As in mast cells, degranulation can be triggered by mastoparan, which does not increase cytosolic Ca^{2+} as detected with fura 2 (Wheeler-Jones, Saermark et al. 1992). In the nominal absence of cytosolic Ca^{2+} , activation of PKC by phorbol esters and stimulation by $\text{GTP}\gamma\text{S}$ act synergistically, promoting dense granule and α -granule secretion, while either stimulus alone is sufficient for maximal response only in the presence of Ca^{2+} (Haslam and Coorssen 1993). The secretory response elicited by PMA is considerably accelerated in the presence of modestly increased concentrations of cytosolic Ca^{2+} , which by itself does not induce

secretion (Rink, Sanchez et al. 1983). It has been reported that elevation of cytosolic Ca^{2+} to pCa^{2+} -values of 5.1 induces a 50% release of granular content of serotonin, and that this response is greatly enhanced by co-stimulation with $\text{GTP}\gamma\text{S}$, or with thrombin (Haslam and Davidson 1984; Knight and Scrutton 1985; Knight and Scrutton 1986). The release of dense granule contents can also be triggered by addition of exogenous inositol 1,4,5-trisphosphate to saponin-permeabilized platelets. This underlines that Ca^{2+} plays a role as the triggering pathway in receptor-mediated degranulation in platelets (Israels, Robinson et al. 1985). In addition to this report, it has also been reported that onset of thrombin-induced α -granule secretion and lysosomal secretion correlate with breakdown of phosphatidylinositol 4,5-bisphosphate, but not with other phosphoinositides (Marche, Rendu et al. 1985). Despite a uniform rise of Ca^{2+} in α -thrombin-stimulated indo-1-loaded platelets, approximately 20% of the cells do not respond with exocytosis, as monitored by cell-surface binding of S12 monoclonal antibodies. Stimulation with ADP also causes a uniform rise in Ca^{2+} but no complete exocytosis (Oda, Daley et al. 1991). A possible explanation could be that the cytosolic levels of Ca^{2+} achieved by physiological stimuli are lower than those used in permeabilized cell systems. Although not sufficient, elevation of cytosolic Ca^{2+} may well be a necessary requirement for degranulation induced by physiological stimuli as was shown in platelets stimulated by collagen in media with or without addition of Ca^{2+} (Packham, Rand et al. 1991). Stimuli such as thrombin and PAF, on the other hand, induce secretion even when fluctuations in cytosolic Ca^{2+} are suppressed (Rink, Sanchez et al. 1983). Hence, it seems as neither is a rise in cytosolic Ca^{2+} a necessary requirement for platelet secretion (in particular when additional signaling pathways are activated), nor is an elevation of Ca^{2+} , within a physiological range, a sufficient triggering signal for induction of secretion.

Cytotoxic T cells and natural killer cells

Influx of Ca^{2+} is a critical event in T-cell activation leading to exocytosis of lytic granules containing the lethal agents perforin and granzyme (Berke 1994). Peculiarly, the lysosomal enzymes of

cytotoxic T lymphocytes (CTL) are found within these specialized secretory granules. Thus, the lytic granules seem to perform two particular functions: as lysosomes within the cell, and as secretory granules when a target cell is recognized (Page, Darmon et al. 1998). Natural killer cells (NK) belong to a subpopulation of lymphocytes, which kill virally infected cells and tumor cells without previously being sensitized (Bonnema, Rivlin et al. 1994). Intracellular signaling pathways involved in regulation of CTL and NK-cells are often studied in experimental systems where cellular activation is monitored by killing of target cells, either through direct cell-to-cell attachment or without direct contact in suspension. Results from such studies may not be directly applied to regulation of degranulation, since killing of target cells might also involve non-exocytotic responses, and could be dependent upon sensitivity of these targets to experimental conditions, such as for instance presence of ion chelators. Lymphocyte degranulation has, however, also been studied by for instance assessment of granular contents release, such as benzyloxycarbonyl-L-lysine thiobenzyl ester-esterase (BLT) (Blanchard, Aubry et al. 1989; Dutz, Fruman et al. 1993). Generally, the exocytotic responses in CTL and NK cells are highly dependent upon influx of Ca^{2+} from an extracellular pool. Adenosine receptor-induced granule exocytosis in NK cells is, for example, sensitive to the extracellular presence of the Ca^{2+} -chelating agent EGTA (Williams, Blay et al. 1997). Ca^{2+} -chelators also inhibit granule exocytosis in CTL, triggered by engagement of the T-cell receptor (TCR), or by stimulation with a combination of PMA and A23187 (Takayama and Sitkovsky 1987; Fortier, Nacy et al. 1989). Lytic activity is strikingly reduced in the absence of extracellular Ca^{2+} (Gray, Gnarra et al. 1987). It should be noted that neither PMA nor Ca^{2+} -ionophore alone is sufficient for exocytosis in CTL (Lancki, Kaper et al. 1989). Ionophore-induced elevation of cytosolic Ca^{2+} triggers intracellular movement of granules, but not degranulation in the absence of PMA (Haverstick, Engelhard et al. 1991). Others reports say that also a combination of these stimuli trigger CTL exocytosis rather inefficiently in comparison to TCR stimulation (Kataoka and Nagai 2000). The lytic process in CTL attached to target cells is associated with a mobilization of Ca^{2+} from intracellular stores at a location other than the contact site, this is then followed by a prolonged phase of elevated cytosolic Ca^{2+}

proximal to the target cell resulting from Ca^{2+} -influx. The latter phase is also associated with oscillations, which are dependent upon extracellular Ca^{2+} (Gray, Gnarr et al. 1988). As in other leukocytes, degranulation in permeabilized CTL and NK cells can be triggered by addition of GTP γ S in a Ca^{2+} -dependent manner (Schrezenmeier, Ahnert-Hilger et al. 1988; Ting, Schoon et al. 1992).

Monocytes and macrophages

Our knowledge about regulated secretion in monocytes and macrophages is sparse in comparison to the current understanding of regulated secretion in other leukocytes. Most of the information available on the molecular regulation of lysosomal secretion in monocytes and macrophages stems from the '70s and '80s. As opposed to research performed on, for instance, neutrophils and mast cells, molecular intervention through patch-clamp and permeabilization techniques has not been widely used in macrophages. To this date, the patch-clamp technique has mostly been applied in elucidation of the regulation of cytosolic Ca^{2+} . However, the latter technique was recently employed in a study on the dynamic interaction between phagocytosis and exocytosis as measured by step-wise changes in membrane capacitance (Holevinsky and Nelson 1998).

Release of lysosomal enzymes can be triggered in cultured Kupffer cells by stimulation with A23187 but not with PMA (Dieter, Schulze-Specking et al. 1988). In this study, however, as well as in other studies mentioned below, the Ca^{2+} -ionophore-induced release of lysosomal enzymes was correlated to leakage of lactate dehydrogenase (LDH) from the cytosol and thus could not be regarded as lysosomal secretion. It should be noted that these Kupffer cells were exposed to A23187 at a concentration of 20 μM for 2 h in a Ca^{2+} -containing medium. Lysosomal secretion, as measured by release of β -galactosidase in mouse peritoneal macrophages stimulated with zymosan or methylamine, is not sensitive to chelation of Ca^{2+} by addition of EGTA (Riches, Watkins et al. 1983). Only minor effects on zymosan-induced release of N-acetyl β -D-glucosaminidase are seen when varying extracellular concentrations of Ca^{2+} in the range between 0 (in the presence of EGTA) to 1 mM. Furthermore, depletion of intracellular Ca^{2+} -stores through addition of A23187 to a Ca^{2+} -free

medium does not reduce the lysosomal secretory response (Tapper and Sundler 1995c). Lysosomal secretion in response to A23187 alone was in the latter study observed only at higher concentrations of extracellular Ca^{2+} , accompanied by release of LDH. Addition of ethylenediaminetetraacetic acid (EDTA) has however in an earlier study been shown to cause inhibition of lysosomal secretion induced by zymosan, but not by methylamine, which was explained by a reduced cellular association of zymosan in the presence of EDTA (Riches, Watkins et al. 1983). This conclusion was further strengthened by the findings that longer incubations with zymosan reduced effects on binding of zymosan, as well as release of lysosomal enzymes. The discrepancy between the effects of EGTA and EDTA indicates a role for Mg^{2+} either in binding of zymosan to a putative receptor, or in the concomitant secretory process, a topic which has also been addressed in zymosan-treated peritoneal macrophages (McMillan, Macintyre et al. 1980). In the latter study it was also shown that A23187, in the presence of extracellular Ca^{2+} , induces a concentration-dependent release of lysosomal enzymes, which is closely related to LDH, and thus a result of loss of cellular integrity. Release of lysosomal enzymes is a feature shared also by macrophage precursors. Stimulation of monocytes with opsonized zymosan results in a substantial release of lysosomal enzymes (N-acetyl- β -glucosaminidase). A similar release is triggered also in the absence of zymosan, when PKC is activated by PMA (Kelly and Carchman 1987). Such secretion is brought about seemingly without elevation of cytosolic Ca^{2+} as PMA has been shown not to elevate cytosolic Ca^{2+} in for instance neutrophils (Fujita, Irita et al. 1984). Lysozyme and lysosomal hydrolases are released constitutively in macrophages, but a distinct difference in the release of lysozyme, and other lysosomal enzymes, is found in stimulus-induced regulated secretion. Approximately 30% of the total content of lysozyme is released upon stimulation with either A23187 or PMA, whereas only a minor release of lysosomal acid hydrolases is observed in response to these stimuli (Ho and Klempner 1985). Some observations indicate that lysozyme is packed in a distinct class of cytoplasmic granules in macrophages and monocytes (Gordon, Todd et al. 1974).

A conclusion seems to be, that extracellular Ca^{2+} does not play a significant role in macrophage and monocyte lysosomal secretion, either induced by particulate stimuli (Ackerman, Beebe et al. 1977; Gordon, MacIntyre et al. 1977; Tapper and Sundler 1995c) or by stimuli that elevate lysosomal pH (Riches, Watkins et al. 1983).

Phosphatidylinositol 3-kinase

Phosphatidylinositol (PtdIns) resides on the cytosolic face of membranes, and can be phosphorylated by different phosphoinositide kinases on the 3, 4, and 5-position of the inositol ring to form PtdIns(3)P, PtdIns(4)P, PtdIns(3,4)P₂, PtdIns(4,5)P₂, and PtdIns(3,4,5)P₃ (Figure 2). These phosphoinositides, together with their respective phosphoinositide kinase, are part of an important agonist-stimulated lipid signalling system, which controls cellular functions such as growth, differentiation and survival (Rameh and Cantley 1999). In phagocytes, the phosphoinositides regulate functions such as actin polymerization, chemotaxis and respiratory burst (Wymann, Sozzani et al. 2000). Signals propagate from these phosphoinositides by means of specific interaction with certain protein domains. Pleckstrin homology (PH) domains show high affinity for PtdIns(3,4)P₂ and PtdIns(3,4,5)P₃. FYVE is another such domain specific for PtdIns(3)P (Thorner 2001; Gillooly, Simonsen et al. 2001). Of special interest in membrane trafficking and exocytosis are the phosphoinositides phosphorylated on the 3-position of the inositol ring. Originally, two yeast mutants were characterized, namely Vps34p and Vps15p, with defective membrane traffick (Cockcroft and De Matteis 2001). These mutant genes were later found homologous to the catalytic and regulatory subunit, respectively, of the mammalian phosphoinositide 3-kinase (PI3K). Hence, PI3K is a heterodimer where the regulatory subunit associates with membranes either through agonist induced G-protein signalling, or through SH2-dependent association with phosphorylated protein tyrosine kinase receptors. Several isoforms of these subunits have been identified since, and the heterodimers are subdivided into 3 classes (Vanhaesebroeck and Waterfield 1999). Members of class I and II are activated by agonist- induced stimulation and they phosphorylate PtdIns, PtdIns(4)P and PtdIns(4,5)P₂. Class III kinases, whose

substrate is PtdIns, are constitutively active and are responsible for production of most cellular PtdIns(3)P. Among signalling pathways identified downstream of PI3K, can be mentioned association with tyrosine kinases, leading to activation of PLC $\gamma_{1/2}$, Rac guanine nucleosid exchange factor, leading to activation of Rac, and association of phosphoinositide-dependent kinase-1 (PDK1) with protein kinase B (PKB) (Vanhaesebroeck and Waterfield 1999).

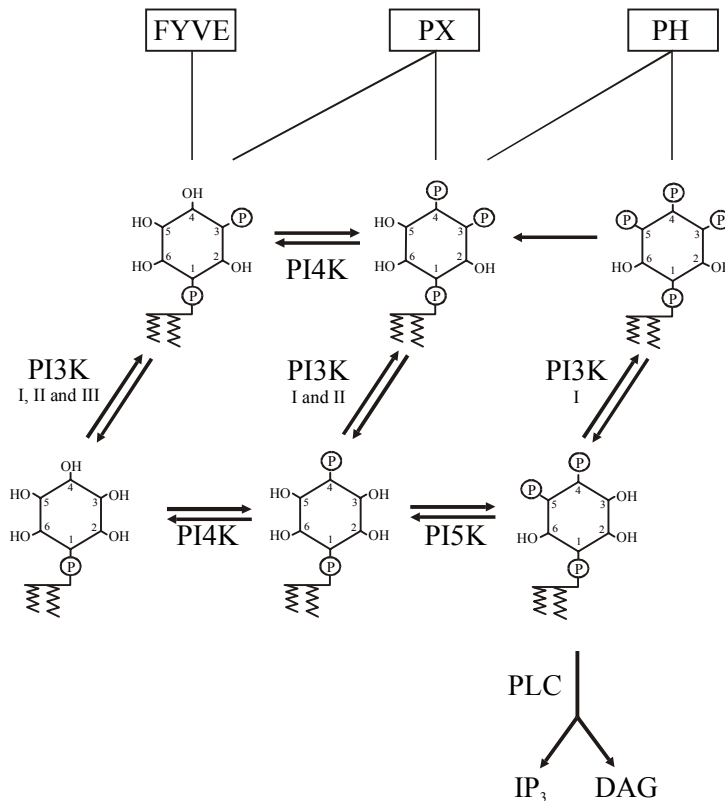

Figure 2. Phosphoinositides and their binding by protein domains.

PDK1 is a PH domain-containing serine/threonine kinase which translocates to membranes upon activation of PI3K. At the membrane, PDK1 phosphorylates and activates PKB, another serine/threonine kinase containing a PH domain. Activation of PKB is considered

important for PI3K-mediated cell survival, and for exocytotic up-regulation of glucose transporters (Corvera and Czech 1998). Translocation of PDK1 can also lead to phosphorylation of the PKC family members on the activation loop. Such phosphorylation, which is described below, sets these enzymes in a state primed for activation. Further, the PKC isoforms ϵ and ζ can be directly activated through association with PtdIns(3,4)P₂ as well as PtdIns(3,4,5)P₃ (Toker 2000). The two cell-permeable, but otherwise structurally unrelated inhibitors, wortmannin and LY294002 have greatly contributed to our current understanding of regulation of cellular functions by PI3K. Wortmannin covalently binds to the catalytic subunit, and LY294002 acts by competing at the ATP-binding site (Vanhaesebroeck and Waterfield 1999). Both wortmannin and LY294002 potently inhibit all known isoforms of PI3K. Wortmannin is thought to be specific for these enzymes at concentrations below 50 nM, while inhibiting phosphoinositide 4-kinase at concentrations above 200 nM as well as myosine-light chain kinase at micromolar concentrations (Corvera and Czech 1998). Although there is currently no data available on regulation of lysosomal secretion by PI3K, it has been shown that this enzyme plays important roles for macrophage functions such as production of arachidonate, phagocytosis, and chemotaxis (Hiller, Sternby et al. 2000; Lennartz 1999; Wymann, Sozzani et al. 2000). However, some data indicating involvement of PI3K in leukocyte degranulation come from studies in neutrophils, mast cells, basophils, and NK-cells. Inhibition of IgE-receptor-dependent degranulation in mast cells by wortmannin has been shown in several studies (Barker, Lujan et al. 1999; Djourer, Schmidt et al. 2001; Hirasawa, Sato et al. 1997; Marquardt, Alongi et al. 1996). Wortmannin further inhibits IgA-mediated histamine release from basophils (Iikura, Yamaguchi et al. 1999). Also, granular exocytosis, induced by ligation of FcR or by cross-linking of CD2 or CD16 in NK-cells, is sensitive to wortmannin (Umehara, Huang et al 1997; Bonnema, Karnitz et al. 1994). In neutrophils, azurophilic degranulation induced by FMLP, but not by PMA, is sensitive to wortmannin (Capodici, Hanft et al. 1998; Hii, Marin et al. 2001; Karlsson, Nixon et al. 2000). The role for PI3K in the macrophage lysosomal secretion is addressed in papers IV and V.

Protein kinase C

Isoforms and expression

As many as 10 members of the protein kinase C family of serine/threonine kinases have to date been characterized, and these isoforms are classified into three groups, based on their ability to bind 1,2-diacylglycerol (DAG), and their sensitivity to Ca^{2+} . Conventional isoforms (α , βI , βII , γ) are activated by Ca^{2+} , DAG and phosphatidylserine (PS). Novel isoforms (δ , ϵ , η and θ) lack the Ca^{2+} -binding domain and are activated by PS, DAG, and unsaturated fatty acids. Atypical isoforms (ι and ζ) are insensitive to Ca^{2+} , do not bind DAG but are activated by PS, phosphoinositides, and by unsaturated fatty acids. The mouse homologue of ι is named PKC λ . Expansion of the PKC family is now being considered as several more distantly related kinases have been discovered. These include PKC μ , also known as PKD, and PKC related kinases (PRKs), also known as PKN (Toker 1998).

Several isoforms are often expressed in the same cell and some isoforms tend to be expressed in a tissue-specific manner (Table 2). PKC α , βI , βII , δ , ϵ and ζ are ubiquitously expressed, and are found in most tissues (Schaap and Parker 1990; Wetsel, Khan et al. 1992; Hug and Sarre 1993). It has also been documented that expression of PKC γ seems to be restricted to the central nervous system (Nishizuka 1988; Nishizuka 1992; Wetsel, Khan et al. 1992), and that PKC η is mainly expressed in skin and lung tissues (Bacher, Zisman et al. 1991).

The ubiquitously expressed isoforms of PKC are in general found in hematopoietic cells, although some lineage-restricted variations can be found (Bassini, Zauli et al. 1999). The isoforms α , βI , βII , δ , and ζ have accordingly been identified in macrophages (Huwiler and Pfeilschifter 1993; Monick, Carter et al. 1998). Expression of PKC is probably dependent upon cell differentiation. Differences have been found between macrophages and their monocytic precursors (Monick, Carter et al. 1998). Some differences are also found between macrophage cell-lines, which might reflect both degree of differentiation as well as species of origin. RAW 264.7 cells (mouse macrophage cell line), for instance, express PKC α , βI , δ , ϵ , and ζ (Larsen, DiGennaro et al. 2000), and possibly also βII , μ , and λ , as

assessed by Western blot analysis (Lin and Chen 1998). Northern analysis of RNA, extracted from the mouse macrophage cell line, J774, shows a constitutive expression of mRNA specific for PKC β I, β II, ϵ and ζ , but not those specific for PKC α , γ or δ . Western blot analysis of cell lysates shows expression PKC β II, ϵ and ζ isoforms, but does not detect expression of PKC β I (Fujihara, Connolly et al. 1994).

Structure

Differences in regulation and binding of co-factors, which exist between the three groups of PKC isoforms, are reflected in their composition of domains (Figure 3). All PKC isoforms contain an N-terminal regulatory region, and a C-terminal catalytic region. PKC isoforms contain several conserved regions (C1-C5), which are interrupted by variable regions (V1-V5). The C1 region, which is present in all isoforms, contains a motif similar to the consensus sequence for PKC substrate phosphorylation, and it functions as a pseudo-substrate blocking the catalytic region, and thus keeping the enzyme in a non-active state (Ron and Mochly-Rosen 1995). Mutation of this region brings about agonist-independent activity in these kinases (Pears, Kour et al. 1990). Important for regulation is also cysteine-rich sequences, which are necessary for DAG and phorbol ester binding (Burns and Bell 1991; Nishizuka 1995). The atypical isoforms contain only one copy of this sequence and do not respond to DAG. The C2 region is found only in conventional isoforms, but homologous sequences have been identified also in variable regions of novel PKC isoforms. Three separate locations in the C2 region have been shown to bring about interactions with PS, and at least one of these locations is also believed to constitute a Ca^{2+} -binding site (Bell and Burns 1991, Lee and Bell 91, Quest 1996). The importance of this region in Ca^{2+} /phospholipid-dependent translocation to membranes has also been shown *in vivo* (Corbalán-García, Rodríguez-Alfaro et al. 1999). *In vivo* translocation and activation of PKC β can also be inhibited by a C2-derived peptide (Ron, Luo et al. 1995). The C2 region has, furthermore, been found in several Ca^{2+} and phospholipid-binding proteins such as synaptotagmins and cPLA₂. The crystal

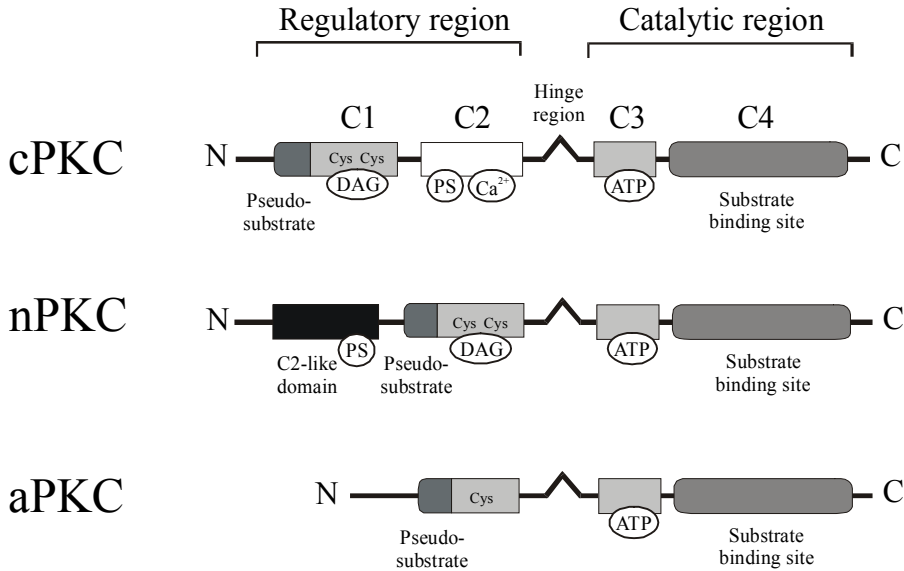

Figure 3. Structure of PKC. cPKC - conventional PKC, nPKC - novel PKC, aPKC - atypical PKC, DAG - diacylglycerol, PS - phosphatidyl serine, Cys - cysteine-rich sequence.

structure of the Ca²⁺/phospholipid binding domain from cPLA₂ was recently elucidated (Perisic, Fong et al. 1998). The N-terminal regulatory domain of PKC is connected through a hinge region (V3) to the C3 region in the catalytic domain. The C3 region contains an ATP-binding sequence similar to those found in other kinases. Also located in the catalytic domain is the C4 region, which contains a substrate-binding site and a phosphate-transfer region (Nishizuka 1992; Hug and Sarre 1993).

Regulation

Activation of PKC is regulated in two steps. Firstly, the enzyme must be in a phosphorylated state in order to be catalytically capable. Secondly, the pseudosubstrate must be removed from the substrate-binding site, an event which is induced by binding of activating ligands. Newly synthesized PKC resides as an inactive enzyme in a detergent insoluble cell fraction (Borner, Filipuzzi et al. 1989). As a first step in becoming a catalytically competent enzyme, PKC is phosphorylated in the activation loop by an unidentified kinase. A

negative charge in this loop (Thr-500 in PKC β II) aligns residues involved in catalysis also in other kinases (Orr and Newton 1994; Taylor and Radzio-Andzelm 1994). This phosphorylation is followed by two autophosphorylations in the C-terminal region of the enzyme (Keränen, Dutil et al. 1995). Autophosphorylation can be seen as a shift in electrophoretic mobility. These phosphorylations stabilize the enzyme in an activation-competent conformation, and release the mature enzyme into the cytosol. Inactive PKC typically resides in the cytosol in an inactive state with its catalytic site blocked by the pseudosubstrate region. In a simplified model of PKC activation, trans-membrane signaling leads to transient activation of phospholipases, production of DAG, and inositol phosphates, which is followed by elevation of cytosolic Ca^{2+} . DAG causes a marked increase in the enzyme's affinity for membranes by acting as a hydrophobic anchor (Nishizuka 1992). This causes translocation of PKC to membranes. In the case of conventional isoforms, Ca^{2+} acts in cooperation with DAG to increase the affinity for negatively charged lipids such as PS (Bazzi and Nelsestuen 1987). A transient production of DAG, associated with release of inositol phosphates, is typically followed by a more persistent second wave of DAG, produced through hydrolysis of phosphatidylcholine. Binding of DAG, as well as Ca^{2+} -promoted association with PS, leads to conformational changes, which in turn causes release of the pseudosubstrate region from the catalytic site (Mosior and Newton 1995; Mosior and Newton 1996). Assessment of PKC translocation to membranes is a widely used method to estimate the state of activity of the enzyme in cells (Hug and Sarre 1993), although current understanding implies greater complexity (Nelsestuen and Bazzi 1991). Translocation of conventional isoforms *in vivo* can be induced either by stimulation with PMA or by elevation of cytosolic Ca^{2+} through treatment with the ionophore A23187. Phorbol esters have been shown to cause a complete translocation of PKC α - tagged with green fluorescent protein (GFP) in baby hamster kidney cells - without any concomitant increase in cytosolic Ca^{2+} (Almholt, Arkhammar et al. 1999). It was also shown in COS-7 cells, transfected with GFP-tagged PKC γ , that deletion or mutation of the C1 or C2 region specifically blocked translocation induced by PMA or A23187, respectively (Sakai, Sasaki

et al. 1997). One should keep in mind, however, that cytosolic localization in certain experimental systems does not necessarily imply inactivity. For instance, active PKC is found in the cytosol of cells treated with bryostatins, a group of substances that can act as pharmacological modulators of PKC (Grabarek and Ware 1993). Others have noticed that PKC isoforms may exert functions even in the absence of catalytic activity (Zeidman, Lofgren et al. 1999). Neither is a membrane translocation a reliable marker for activation of PKC. Certain isoforms reside partly translocated in resting cells. This has been shown for PKC δ in neutrophils (Sergeant and McPhail 1997), as well as for δ and ϵ in macrophages (Huwiler and Pfeilschifter 1993; Miura and MacGlashan 1998). Staurosporine, and analogues of bisindolylmaleimide, which are inhibitors of PKC, can also induce translocation on their own, presumably without induction of kinase activity (Wolf and Baggiolini 1988; Kiley, Parker et al. 1992; Jones, Courage et al. 1997). Translocation of PKC is probably not governed just by conventional activating signaling pathways. PKC isoforms can in some cell-types show predilection for certain organelles like the nucleus, or Golgi stack. Such restricted translocations are likely to be regulated by specific protein interactions, and to bring about specific cellular functions (Dekker and Parker 1994; Kiley, Jaken et al. 1995; Quest 1996).

Down-regulation

Chronic activation of PKC (e.g. by phorbol esters) leads to down-regulation (Nishizuka 1995). This down-regulation is a result of accelerated breakdown of PKC through enzymatic cleavage, presumably occurring following translocation to membranes. Proteolytic cleavage initially produces active intermediates of PKC, which also might represent an alternative physiological pathway to activation of PKC in certain cell-types (Muramatsu, Kaibuchi et al. 1989). Although current understanding of the degradation-process of PKC is still limited (Parker, Bosca et al. 1995), it has been suggested that PKC is degraded in the proteasome through ubiquitination (Lee, Smith et al. 1996). Isoforms of PKC show differential sensitivity to treatment with phorbol esters, which can be used to induce a selective down-regulation in order to analyze the function of specific isoforms

in vivo. Conventional isoforms tend to be more sensitive to down-regulation than novel isoforms which in turn are more sensitive than atypical isoforms, which are resistant to phorbol ester-treatment. Differences among isoforms in sensitivity to various isomers of DAG and tumor-promoting agents have been suggested, which can be used for isoform-selective down-regulation, and thus as a tool for analysis of isoform-specific functions (Huwiler, Fabro et al. 1994; Geiges, Meyer et al. 1997; Sanchez-Pinera, Micol et al. 1999). Down-regulation of PKC by phorbol esters is preceded by a transient period of increased activity. When short-time down-regulation of conventional isoforms is performed, such transient activation of conventional isoforms, and the more persistent activation of novel isoforms, should be taken into account. Also, when treating cells with phorbol esters for longer periods of time in order to obtain complete down-regulation of conventional and novel isoforms, a possible alteration in cellular functions through activation of transcription factors and protein expression may have to be considered.

Non-PKC specific inhibitors

Staurosporine

Staurosporine is an alkaloid found in *Streptomyces sp.*, and was first identified as an anti-fungal agent (Omura, Iwai et al. 1977). Staurosporine was later shown to potently inhibit PKC *in vitro*, but other kinases such as cAMP-dependent protein kinase (PKA), Ca²⁺/calmodulin-dependent protein kinase II, and p60v-src tyrosine kinase, were inhibited with similar IC₅₀ values (Tamaoki, Nomoto et al. 1986; Nakano, Kobayashi et al. 1987; Yanagihara, Tachikawa et al. 1991). Inhibition of tyrosine kinases has been shown in several cell types (Fallon 1990; Badwey, Erickson et al. 1991; Nye, Squinto et al. 1992). The exact mechanism through which staurosporine inhibits PKC is not known, but the findings that it can inhibit also a proteolytically generated catalytic fragment of PKC, together with the lack of effect on phorbol ester binding, suggests that the ATP-binding site is a target for this substance (Nakadate, Jeng et al. 1988). The inhibitory effect of staurosporine is of a noncompetitive nature with respect to ATP (Yanagihara, Tachikawa et al. 1991). Binding of staurosporine to PKC can be displaced by the staurosporine-related

compound K-252a, but not H-7, suggesting a common site of action for the former two substances (Herbert, Seban et al. 1990). It can be concluded that the poor selectivity found when assayed against other protein kinases (Toullec, Pianetti et al. 1991), renders staurosporin a substance unsuitable for intervention of PKC functions.

K252

Several different microbial products, which contain the same indole carbazole backbone as staurosporine, share the ability to inhibit protein kinases. Members of the K-252-family of substances are alkaloid-like compounds isolated from *Nocardioopsis sp. K-290*. These molecules share a common poly-aromatic aglycon structure with various other inhibitors of protein kinases (Knusel and Hefti 1992). K-252a has proved to be a potent inhibitor of protein kinase C (Kase, Iwahashi et al. 1987). K-252b, c, and, d are all structurally related, originate from the same species, and are also inhibitors of PKC (Nakanishi, Matsuda et al. 1986). The K-252 compounds act by interfering with the ATP-binding site in PKC (Kase, Iwahashi et al. 1987; Hashimoto, Nakayama et al. 1991). Binding of staurosporine to PKC can, as mentioned, be displaced by the staurosporine-related compound K-252a. The dissociation constant for PKC is comparable to that for PKA, tyrosine protein kinases, and Ca²⁺/calmodulin-dependent kinase, suggesting low specificity toward PKC (Herbert, Seban et al. 1990; Fabre, Prudhomme et al. 1993). K-252a has also been shown to inhibit p42/44 MAP kinase, phosphorylase kinase, and autophosphorylation of receptor tyrosine kinases (Elliott, Wilkinson et al. 1990; Lloyd and Wooten 1992; Nye, Squinto et al. 1992).

H-7

When the naphthalene ring is replaced by isoquinoline in the calmodulin (CaM) antagonist N-(6-amino-hexyl)-5-chloro-1-naphthalenesulfonamide (W-7), the derivatives are no longer CaM antagonists but retain the ability to inhibit other protein kinases. PKA, cGMP-dependent kinase (PKG), myosin light chain kinase, and PKC isoforms are in contrast to CaM potently inhibited by 1-(5-isoquinolinylsulfonyl)-2-methylpiperazine (H-7), which is one of these derivatives (Hidaka, Inagaki et al. 1984). H-7 inhibits PKA, PKG, and PKC, with roughly equal potency (Quick, Ware et al. 1992). In

contrast to staurosporine, H-7 does not seem to inhibit tyrosine kinases *in vivo* (Fallon 1990; Badwey, Erickson et al. 1991), and unlike the PKC-specific inhibitors chelerythrine and calphostin C, H-7 inhibits PKC through interaction with the ATP-binding site in the catalytic domain (Nakadate, Jeng et al. 1988). Unfortunately, the ATP-binding site of PKC shows striking homology with ATP-binding sites of other serine, threonine as well as tyrosine kinases. Although commonly used as a PKC-inhibitor the lack of specificity makes this inhibitor a blunt tool in the study of PKC functions *in vivo*.

Sphingosine

Sphingosine, a naturally occurring backbone moiety of sphingomyelin and gangliosides, has been identified as a potent inhibitor of PKC (Merrill, Nimkar et al. 1989). This compound interacts with the DAG-binding site of PKC, and the inhibition is competitive with regards to phorbol esters (Hannun, Loomis et al. 1986; Oishi, Raynor et al. 1988). Although no inhibitory effect is seen on other kinases, such as myosin light chain kinase, and PKA (Merrill and Stevens 1989), sphingosine can bind and regulate CTP:phospho-choline cytidyltransferase and Na⁺,K⁺-ATPase (Oishi, Zheng et al. 1990; Sohal and Cornell 1990).

PKC-specific inhibitors

Chelerythrine

The benzophenanthridine alkaloid chelerythrine, isolated from *Zanthoxylum simulans* (Ko, Chen et al. 1990), interacts with the catalytic domain of PKC, and is a competitive inhibitor with regard to the phosphate acceptor histone H1. Chelerythrine is neither a competitive inhibitor with respect to ATP, nor does it affect binding of phorbol esters to PKC (Herbert, Seban et al. 1990). Chelerythrine is further selective toward PKC as compared to protein tyrosine kinases, PKA, and Ca²⁺/calmodulin-dependent kinase (Herbert, Seban et al. 1990).

Calphostin C

Calphostin C is a polycyclic hydrocarbon metabolite from the fungus *Cladosporium cladosporioides*, which inhibits PKC by competing, at

the binding site, for DAG and phorbol esters. Inhibition of PKC by calphostin C is irreversible, dependent upon exposure to light (Bruns, Miller et al. 1991), and requires oxidation as well. Physical quenchers of singlet oxygen reduce calphostin C-induced inhibition of PKC (Gopalakrishna, Chen et al. 1992). Calphostin C inhibits PKC three orders of magnitude more potently than it does PKA. Interaction with the regulatory region in PKC has been proposed and calphostin C inhibits binding of phorbol esters (Kobayashi, Nakano et al. 1989). Calphostin C shows no selectivity among the C1-containing isoforms belonging to conventional and novel isoforms of PKC (Arecas, Kazanietz et al. 1994; Rotenberg, Huang et al. 1995).

Bisindolylmaleimides

A series of potent and selective inhibitors of PKC have been identified among the bisindolylmaleimides. These inhibitors are derived from the structural lead provided by the non-selective protein kinase inhibitor staurosporine (Davis, Hill et al. 1992), and thus they interfere at the ATP-binding site (Toullec, Pianetti et al. 1991; Davis, Elliott et al. 1992; Bit, Davis et al. 1993). The simplest bisindolylmaleimide is Ro 31-7208. This substance is a less potent, but more specific, inhibitor of PKC as compared to staurosporine. Bisindolylmaleimides carrying straight-chain alkyl side-chains bearing a cationic constituent, such as Ro 31-7549 and Ro 31-8220, are more potent than Ro 31-7208 and slightly selective toward conventional isoforms as compared to novel isoforms. Most noticeable among the bisindolylmaleimides is the compound Ro 32-0432, which shows a 10-fold higher selectivity for PKC α , and a 4-fold higher selectivity for PKC β I, over PKC ϵ (Wilkinson, Parker et al. 1993). The aminoalkyl bisindolylmaleimide GF109203X, also named Gö 6850, is one of the most frequently used PKC-inhibitors in the literature. This inhibitor shows a high selectivity for PKC and inhibits all PKC isoforms, however, with a ranked order of potency: $\alpha > \beta$ I $> \epsilon > \delta > \zeta$ (Martiny-Baron, Kazanietz et al. 1993). The atypical PKC ζ is inhibited 10-fold less potently than PKC α . GF109203X, as well as other bisindolylmaleimides, does inhibit PKA, but only at concentrations a 100 times higher than those required for 50% inhibition of PKC. EGF, and PDGF receptor tyrosine kinases are not affected by these inhibitors (Davis, Hill et al. 1992). Some non-

PKC related effects have been reported though. GF109203X can, for instance, interfere with telomerase activity, and effects on PKC-independent activation of stress-activated protein kinase JNK1 have been reported as well (Beltman, McCormick et al. 1996; Ku, Cheng et al. 1997).

Indolocarbazoles

Whereas staurosporine and K252a are known to suppress the activity not only of PKC, but also of various other kinases (Ruegg and Burgess 1989; Gschwendt, Kittstein et al. 1994), the indocarbazole Gö 6976 has been identified as rather specific for PKC (Gschwendt, Fürstenberger et al. 1995). Effects of Gö 6976 on *in vitro* activity of recombinant PKC isozymes α , β I, δ , ϵ , and ζ have been studied. Nanomolar concentrations of Gö 6976 inhibit the Ca^{2+} -dependent isozymes α and β I, while Ca^{2+} -independent isoforms of PKC remain unaffected even at micromolar concentrations. Kinetic analysis has revealed that PKC inhibition by Gö 6976 is competitive with respect to ATP, non-competitive with respect to protein substrates, and of mixed type with respect to phosphatidylserine (Martiny-Baron, Kazanietz et al. 1993).

Peptide inhibitors

Alongside the manufacturing of refined inhibitory compounds by pharmaceutical companies, development of peptides has yielded some very specific and isoform-selective inhibitors of PKC. These synthetic peptides correspond to various regions in PKC, and thus they block functions such as substrate binding or translocation. A peptide derived from the pseudosubstrate sequence in the regulatory domain of PKC (aa19-36) acts as a potent antagonist and inhibits both autophosphorylation and protein substrate phosphorylation (House and Kemp 1987). PKC β and novel isoforms of PKC have very different substrate specificities. For instance, PKC β , but not novel isoforms, can phosphorylate p47-phox in neutrophils. Accordingly, a peptide derived from the pseudosubstrate region (aa19-36) of the C-terminus of Ca^{2+} -dependent PKC isoforms can inhibit the activity of β -PKC without interfering with activities of novel isoforms of PKC (Majumdar, Kane et al. 1993). However, the usage of synthetic

peptides as specific inhibitors, is held back by poor cell permeability. This problem has been solved by N-myristoylation of such peptides, which allows passage into, and inhibition of PKC in intact cells (Eichholtz, de Bont et al. 1993). Several peptides have also been identified which interfere with translocation of PKC. For instance, translocation of PKC ϵ can be selectively inhibited by an octapeptide derived from the V1 region in PKC ϵ (Johnson, Gray et al. 1996). RACK1 (receptor for activated C kinase) has been described as a PKC-binding protein, which anchors the activated enzyme near its protein substrate. This receptor interacts with the C2 domain of PKC, and peptides, corresponding to various regions in the C2-domain of the β isoform, inhibit PMA-induced translocation and activation of this isoform *in vivo* (Ron, Luo et al. 1995). Among other approaches used in the study of PKC, can be mentioned stable transfection with inactive PKC mutants (Garcia-Paramio, Cabrerizo et al. 1998), treatment with antisense oligonucleotides targeting specific isoforms of PKC (Chen, Wang et al. 1998), and PKC knockouts (Ramakers, Gerendasy et al. 1999).

Protein kinase C in exocytosis

Neutrophils

The isoforms PKC α , β I, β II, δ , and ζ are expressed in human neutrophils (Majumdar, Rossi et al. 1991; Smallwood and Malawista 1992; Dang, Hakim et al. 1994; Kent, Sergeant et al. 1996). It has been stated however, that PKC α originates from contamination by platelets in neutrophil preparations from blood (Devalia, Thomas et al. 1992; Bates, Bertics et al. 1993; Dang, Rais et al. 1995), and that intrinsic PKC α is down-regulated already during neutrophil terminal differentiation (Devalia, Thomas et al. 1992).

Table 2. Distribution of PKC isoforms in tissues and cell-types as assessed by Northern or Western blot analysis

Tissue/cell	conventional				novel				atypical		reference
	α	β _I	β _{II}	γ	δ	ϵ	η	θ	ι/λ	ζ	
Brain	+	+	+	+	+	+	+	+	+	+	(1)
Lung	+	+	+		+	+	+	+	+	+	(1)
Heart	+	+	+		+	+	+	+	+	+	(1)
Neutrophil	+	+	+		+					+	(1-5)
Eosinophil	+	+	+		+	+	(+)			(+)	(1, 6)
Basophil	+	+	+		+	+				-	(7-8)
Platelet	+	+	+		+	+	(+)	+		+	(1)
CTL [†]	+	+			+	(+)	+	+		+	(9-11)
Monocyte	+	+	+		+	+	+			+	(12)
Macrophage	+	+	+		+	+				+	(13)

[†] antibody reacting with both PKC β _I and β _{II} was used. Parenthesis denotes uncertainty or contradictory data

(1) Webb, Hirst et al. 2000 (2) Dang, Hakim et al. 1994 (3) Kent, Sergeant et al. 1996 (4) Majumdar, Rossi et al. 1991 (5) Smallwood and Malawista 1992 (6) Evans, Lindsay et al. 1999 (7) Miura and MacGlashan 1998 (8) Ozawa, Szallasi et al. 1993 (9) Hug and Sarre 1993 (10) Baier, Telford et al. 1993 (11) Keenan, Long et al. 1997 (12) Monick, Carter et al. 1998 (13) Huwiler and Pfeilschifter 1993

Anyway, PKC is found mainly in the cytosol of non-stimulated neutrophils, whereas a significant translocation to fractions containing the plasma membrane is observed after stimulation by PMA, 1-oleoyl-

2-actetylglycerol (OAG), or ionomycin. More than 75% of the total cellular content of PKC is located in the cytosol in resting cells (Balazovich, Smolen et al. 1986). The involvement of PKC in regulation of respiratory burst in neutrophils is well documented (Tauber 1987). Activation of PKC by phorbol esters triggers a powerful production of O_2^- (Nauseef, Volpp et al. 1991). The role of PKC in regulation of degranulation, on the other hand, is, although addressed in numerous studies, still more of an open question. The first line of evidence for involvement of PKC in neutrophil degranulation comes from experiments where PKC has been artificially activated in the absence of physiological stimuli. Direct activation of PKC, either by phorbol esters or analogues of DAG, triggers release of specific granules in neutrophils. The examples are numerous (Esaguy, Aguas et al. 1991; Cabanis, Gressier et al. 1996; White, Huang et al. 1984; Pontremoli, Melloni et al. 1986; Kang, Tsuda et al. 1985; Zaman, Mitsuyama et al. 1994). It should be noted that PMA does not affect base-line levels of cytosolic Ca^{2+} even at higher concentrations (Pontremoli, Melloni et al. 1986). Phorbol esters are on the other hand poor inducers of azurophilic degranulation, and PMA alone causes only a minor release of myeloperoxidase (MPO) in neutrophils (Nagaji 1999). Azurophilic degranulation is however seen in response to PMA when cytosolic Ca^{2+} is elevated by A23187 as well as in response to OAG, when cytosolic Ca^{2+} is elevated in a permeabilized system (Kang, Tsuda et al. 1985; Zaman, Mitsuyama et al. 1994). Other studies report substantial azurophilic degranulation in response to PMA, but only at higher concentrations (Pontremoli, Melloni et al. 1986). Studies carried out on permeabilized neutrophils stimulated with Ca^{2+} and $GTP\gamma S$, and studies performed with intact cells stimulated with physiological agents, suggest a role for PKC in modulation and maintenance of degranulation, rather than a direct triggering role. Exocytosis in electro-permeabilized neutrophils triggered by Ca^{2+} and $GTP\gamma S$ does not require ATP, but cells soon become refractory in its absence. Protein phosphorylation events thus seem necessary for maintaining a degranulation-responsive state in neutrophils. Inhibition of PKC does not inhibit Ca^{2+} and $GTP\gamma S$ -induced exocytosis, but inhibits the ATP-induced prevention of the refractory state (Boonen, van Steveninck et al. 1992). Furthermore, the

exocytotic response to Ca^{2+} , with or without guanine nucleotides, is unaffected by inhibitors of PKC (Smolen, Stoehr et al. 1989), and secretion induced by Ca^{2+} in electro-permeabilized neutrophils is enhanced in the presence of Mg^{2+} -ATP (Smolen and Sandborg 1990). Although degranulation triggered by phorbol esters is inhibited by staurosporine, calphostin C and GF109203X (Dewald, Thelen et al. 1989; Zaman, Mitsuyama et al. 1994; Cabanis, Gressier et al. 1996), the secretory response to A23187 in intact cells, or to Ca^{2+} and $\text{GTP}\gamma\text{S}$ in permeabilized cells, is insensitive to inhibition of PKC (Berkow, Dodson et al. 1987; Boonen, van Steveninck et al. 1992; Cabanis, Gressier et al. 1996). It should be taken into consideration, when evaluating the necessity and involvement of PKC in neutrophil degranulation, that also exocytotic responses to several physiological stimuli show little sensitivity toward pharmacological inhibition of PKC. Even though degranulation induced by FMLP and leukotriene B_4 (LTB_4) can be inhibited by the non-specific PKC-inhibitor K252a, the secretory response to challenge with opsonized zymosan is just marginally sensitive to inhibition of PKC (Smith, Justen et al. 1988a; Nagaji 1999). Information from *in vitro* characterization of inhibitors cannot always be translated into the *in vivo* situation in a straightforward manner. Caution is called for, since agents, such as staurosporine, have been shown to induce neutrophil degranulation of specific granules and secretory vesicles by themselves (Dewald, Thelen et al. 1989). Phorbol esters can, in addition to their secretion-inducing effects, also be used to study involvement of PKC in modulation of degranulation induced by physiological stimuli. Clearly the involvement of PKC in neutrophil degranulation is dependent upon which stimulus, and which granule, that is being focused. Evidence has also been presented for a negative involvement of PKC in the regulation of degranulation triggered by FMLP, LTB_4 , and cross-linking of the integrin receptor CD18 (Sha'afi, Molski et al. 1986; Berkow, Dodson et al. 1987; Walzog, Seifert et al. 1994). An inhibitory effect by activation of PKC by PMA in degranulation induced by FLMP and LTB_4 , seems to be due to reduction of stimulus-induced elevation of cytosolic Ca^{2+} as measured by fura-2 (Naccache, Molski et al. 1985; Smith, Justen et al. 1988b). An interesting approach in the study of specific roles of PKC isoforms is depletion

through antisense-treatment, which has been used in HL60 cells, where it was shown that PKC β is an important mediator of agonist-induced respiratory burst. An other possible conclusion from this study is that PKC β does not seem to be involved in the release of β -glucuronidase (azurophilic degranulation) induced by FMLP, immune complexes or PMA in HL60 cells (Korchak, Rossi et al. 1998).

Eosinophils

As in mast cells, a role for PKC in the maintenance of secretory competence is seen in permeabilized eosinophils challenged with Ca^{2+} and $\text{GTP}\gamma\text{S}$. In analogy to what has been described for neutrophils, responsiveness to these secretory stimuli in permeabilized cells is prolonged by the presence of ATP, which in turn has no effect if PKC is pharmacologically inhibited (Cromwell, Bennett et al. 1991). Although no enhancement of secretion can be induced by PMA, an acceleration of fusion pore expansion has been noted in patch-clamped mast cells stimulated with Ca^{2+} (Scepek, Coorssen et al. 1998). PMA causes degranulation and release of eosinophilic cationic protein (ECP) in intact cells, a response which can be inhibited by staurosporine and K252a (Egsten, Gullberg et al. 1993). Furthermore, secretion induced by contact with serum-opsonized non-phagocytosable particles is inhibited by staurosporine and calphostin C (Egsten and Malm 1998). A negative involvement of PKC in eosinophilic cell degranulation has also been suggested since release of eosinophil peroxidase triggered by C5a, PAF, or FMLP is enhanced in the presence of staurosporine (Kernen, Wymann et al. 1991).

Basophils and RBL-2H3 cells

Rat basophilic cells express the PKC isoforms α , β , δ , ϵ , and ζ (Ozawa, Szallasi et al. 1993). PMA alone has little effect on resting cytosolic levels of Ca^{2+} or histamine release in RBL-2H3 cells (Sagi-Eisenberg and Pecht 1984; Beaven, Guthrie et al. 1987). PMA-induced activation of PKC, on the other hand, enhances secretion of serotonin induced by IgE-crosslinking, antigenic stimuli, or Ca^{2+} ionophores, which reveals a potential positive involvement of PKC in regulation of exocytosis in RBL-2H3 cells (Sagi-Eisenberg and Pecht 1984; Gat-Yablonski and Sagi-Eisenberg 1990). Some conflicting data

have been reported in this area though. On one hand antigen-triggered exocytosis in RBL-2H3 cells is sensitive to inhibition of PKC by Ro 31-7549, calphostin C, and also a synthetic inhibitory peptide (Yamada, Jelsema et al. 1992). Similar observations have been made in IgE-stimulated human basophils treated with staurosporine or sphingosine (Warner and MacGlashan 1990). On the other hand an inhibitory effect of calphostin C and other agents on human basophilic degranulation, induced by IgE-crosslinking, has been confirmed, but in the same study was also noted that Ro 31-7549 had an opposite effect, and that the related inhibitor staurosporine also enhanced degranulation induced by A23187 (Bergstrand, Lundquist et al. 1992). Enhancement of secretion has also been seen upon inhibition of PKC by staurosporine and sphingosine in FMLP-stimulated basophils, while other studies report that such inhibition has no effect (Warner and MacGlashan 1990; Bergstrand, Lundquist et al. 1992). Stimulation of RBL-2H3 cells with A23187 results in two peaks of degranulation. In contrast to the rapid peak initiated within 60 sec, which like IgE-induced degranulation is sensitive to Ro 31-8425, Ro 31-8220, and chelerythrine, a delayed slower peak of PKC-independent degranulation appearing after several minutes is induced by A23187 (Ozawa, Kobayashi et al. 1996). Through study of RBL-2H3 cell variants, which differ in expression of PKC isoforms, it has been suggested that at least two isoforms, one with positive and the other one with negative effects, are involved in IgE-mediated antigen-induced degranulation (Monk, Bingham et al. 1993). Efforts have also been made to pinpoint specific roles of PKC isoforms in basophil degranulation, and involvement of certain isoforms in mediation of degranulation has been suggested. Permeabilized cells lose responsiveness to secretory stimuli as cytosolic proteins leak out. This loss of responsiveness can be overcome by addition of exogenous PKC β or δ . Loss of responsiveness can also be delayed in permeabilized cells where Ca^{2+} -independent PKC isoforms are maintained through PMA-induced membrane association, while Ca^{2+} -dependent isoforms, being more sensitive to phorbol esters, are down-regulated (Ozawa, Szallasi et al. 1993).

Mast cells

Mast cells and basophils play a crucial role in immunological and allergic processes due to the release of inflammatory mediators such as histamine. Although involvement of PKC in mediation of histamine release has been known for some time, the distinct roles of PKC isozymes in regulation of for instance histamine release in different cell types remain unclear. The topic has been addressed using several different approaches. Activation of PKC by PMA in mast cells results in a relatively slow and modest release of histamine (Bronner, Valle et al. 1986; Chakravarty, Kjeldsen et al. 1990). Activation of PKC also enhances secretion triggered by GTP γ S and Ca²⁺ in permeabilized cells, and triggered by A23187 in non-permeabilized cells (Bronner, Valle et al. 1986; Chakravarty, Kjeldsen et al. 1990; Koopmann and Jackson 1990). Release of granular contents induced by GTP γ S and Ca²⁺ is sensitive to down-regulation of PKC through long term treatment with PMA, which further indicates an involvement of PKC in this process (Koopmann and Jackson 1990). ATP is furthermore required in these permeabilized systems to maintain secretory competence over time (Lillie, Whalley et al. 1991). Involvement of PKC in mast cell exocytosis seems stimulus-specific, since secretion triggered by the basic compound 48/80 decreases upon activation of PKC by PMA (Bronner, Valle et al. 1986), and the process is not sensitive to inhibition of PKC by K252a or GF109203X (Shefler, Taube et al. 1998). Little is known about the role of specific isoforms in mast cell degranulation, but a reduction of exocytosis has been noted in PKC β -deficient mast cells stimulated through the Fc ϵ RI-receptor, or by the calcium ionophore ionomycin (Nechushtan, Leitges et al. 2000).

Platelets

In general it is believed that PKC plays an important role in agonist-induced platelet aggregation and exocytosis. PMA, by itself, triggers degranulation in platelets (Rink, Sanchez et al. 1983; Hashimoto, Togo et al. 1994). Such activation of PKC is also required for maximal degranulation in permeabilized platelets stimulated with either Ca²⁺ or GTP γ S alone (Coorssen, Davidson et al. 1990; Haslam and Coorssen 1993). An involvement of PKC in degranulation

triggered by physiological stimuli has also been shown, using various inhibitors. Ro 31-7549 partially inhibits thrombin-stimulated degranulation (Hashimoto, Togo et al. 1994), and degranulation triggered by the neutrophil protease cathepsin G is sensitive to inhibition of PKC by GF109203X and by Ro 31-8220 (Si-Tahar, Renesto et al. 1996; Rotondo, Evangelista et al. 1997). Platelet degranulation is also inhibited by a peptide corresponding to the putative *in vivo* phosphorylation site for PKC in the MARCKS (myristoylated alanine-rich protein kinase C substrate) protein (Elzagallaai, Rose et al. 2000). As opposed to these data, it has interestingly been noted that mastoparan-induced phosphorylation of a 45 kDa PKC substrate is sensitive to staurosporine treatment, while degranulation is not (Wheeler-Jones, Saermark et al. 1992).

Cytotoxic T cells and natural killer cells

It has, as opposed to in other blood cells, not been shown that activation of PKC alone by phorbol esters can induce degranulation in CTL. Phorbol esters can however act in synergy with Ca^{2+} -ionophores, causing enhanced granule exocytosis. This degranulation, and that induced by TCR cross-linking, is sensitive to chelation of extracellular Ca^{2+} (Takayama and Sitkovsky 1987; Fortier, Nacy et al. 1989). Degranulation induced by TCR engagement in CTL is inhibited by staurosporine (Mittrucker and Fleischer 1992). Inhibition of PKC by staurosporine, calphostin C, a pseudosubstrate peptide or PMA-mediated down-regulation, inhibits tumor cell destruction by non-specific killer T-lymphocytes through abrogation of granular exocytosis (Stewart and Hoskin 1997).

As in CTL cells, PMA triggers degranulation in NK-cells in a Ca^{2+} -sensitive manner (Atkinson, Gerrard et al. 1990; Ting, Schoon et al. 1992). While adenosine receptor-induced degranulation is inhibited by calphostin C in NK cells, it has been determined that Fc receptor stimulation triggers granule release through a PKC-independent pathway in cloned human NK cells (Bonnema, Karnitz et al. 1994). Pretreatment with GF109203X has no effect on Fc receptor-induced degranulation in these NK cells.

Monocytes and macrophages

There is currently plentiful of data available regarding the involvement of PKC in exocytotic events in various leukocytes and excitatory cells. However, our knowledge on regulation of lysosomal secretion by PKC in macrophages and monocytes has not kept up with the development of analytic tools, such as inhibitors, activators, and live imaging of GFP-tagged proteins. We do know that presentation of particulate stimuli, such as zymosan, to macrophages triggers elevation of cytosolic Ca^{2+} and production of DAG (Emilsson and Sundler 1984; Dieter and Fitzke 1993). Both are well-known activators of PKC. Besides a general activation of cellular PKC, zymosan also triggers a selective translocation of certain isoforms of PKC toward the phagosome (Zheleznyak and Brown 1992; Allen and Aderem 1995; Zheng, Zomerdijk et al. 1995). Phagocytosis in macrophages and monocytes is a Ca^{2+} -independent process, which is modulated by PKC-activity (Di Virgilio, Meyer et al. 1988; Zheleznyak and Brown 1992; Karimi and Lennartz 1995; Larsen, DiGennaro et al. 2000). Evidence for an involvement of PKC in lysosomal secretion in macrophages comes both from reports of secretion-triggering effects by phorbol esters alone, and from reports describing modulation of agonist-induced lysosomal secretion by co-activation of PKC by phorbol esters, or inhibition of PKC, either by pharmacological agents or activator-induced down-regulation. Some data regarding secretion-triggering effects by activation of PKC by phorbol esters seem contradictory. Several reports, however, show that release of lysosomal enzymes can be triggered in macrophages by activation of PKC by phorbol esters in the absence of additional stimuli (Ho, J. L. and Klempner, M. S. 1986; Bonney, Wightman et al. 1980). This secretion, which is insensitive to inhibition of RNA or protein synthesis, is of an exocytotic nature and not a consequence of leakage from damaged cells, as assessed by leakage of LDH (Bonney, Wightman et al. 1980). It has also been shown that substantial amounts of lysosomal enzymes are released upon stimulation also of human monocytes with PMA. Such secretion, which is not triggered by the inactive PMA-analogue 4α -PDD, occurs in a time- and concentration-dependent manner, as measured by the release of N-acetyl- β -D-glucosaminidase (Kelly and Carchman 1987). Other

studies have shown that PMA initiates little or no secretory response as compared to particulate stimuli or agents causing lysosomal alkalinization in monocytes and macrophages (Leoni and Dean 1983a; Leoni and Dean 1983b; Tapper and Sundler 1995c). As mentioned before, lysosomal secretion can as mentioned be triggered by soluble stimuli, such as primary amines, proton ionophores, and inhibitors of the vacuolar proton pump (Tapper and Sundler 1990; Tapper and Sundler 1995a). Such secretion, elicited by alkalinization of lysosomes, seems subjected to a modulation by PKC. Lysosomal secretion triggered by methylamine, monensin, or nigericin, in mouse macrophages is markedly enhanced by PMA-induced activation of PKC (Tapper and Sundler 1995c). A less marked enhancement by artificial activation of PKC is on the other hand seen when macrophages are stimulated by zymosan, but down-regulation of PKC through prolonged incubations with phorbol 12,13-dibutyrate (PDBu) leads to a reduced secretion in these cells (Tapper and Sundler 1995b). Different effects of phorbol esters on secretion induced by particulate and soluble stimuli are further addressed in paper IV and V. To date there is little information on the involvement of different isoforms of PKC in the macrophage secretory response, a topic which is also addressed in paper IV and V. Macrophages express at least 5 isoforms of PKC (α , β , δ , ϵ , and ζ) (Huwiler and Pfeilschifter 1993; Monick, Carter et al. 1998). Differences in expression of PKC isoforms have been noted between macrophage and monocytic cell lines. For instance eight isoforms of PKC (α , β I, β II, δ , ϵ , μ , λ and ζ) are expressed in RAW 264.7 macrophages (Lin and Chen 1998). Correlation between isoform expression and secretory responses in such cell lines might prove to be a valuable source of information. Cell lines can also be used for studying effects of isoform depletion through anti-sense treatment or over-expression of specific isoforms on stimulus-induced lysosomal secretion.

Paper I

Dexamethasone lowers cytosolic pH in macrophages by altering alkalinizing pH-regulatory mechanisms

Dexamethasone is a synthetic glucocorticoid used in treatment of a wide array of inflammatory conditions such as asthma and rheumatic diseases. Steroids exert their functions by binding to intracellular hormone receptors which in turn regulate gene expression through their binding to glucocorticoid response elements in the nucleus. Although treatment with glucocorticoids alters the gene expression in many different cell types, their effects on white blood cells, and especially on macrophages, are probably the most important in treating of inflammatory conditions. Dexamethasone has been shown to inhibit several pro-inflammatory macrophage functions. Since some of these functions such as release of cytokines (Bidani and Heming 1995), production of O_2^- (Swallow, Grinstein et al. 1990; Bidani and Heming 1995) and lysosomal secretion (Tapper and Sundler 1990) are also modulated by pH, we tested the effect of dexamethasone on regulation of cytosolic pH in mouse peritoneal macrophages. Cytosolic pH was measured fluorimetrically using the pH-sensitive probe BCECF-AM, which is trapped through intracellular esterase activity. A highly reproducible reduction of cytosolic pH was found, with or without addition of HCO_3^- in the experimental media. The reduction, being evident at nanomolar concentrations of dexamethasone, gradually appearing within hours, was inhibited by the glucocorticoid receptor antagonist RU38486, and was abrogated by clamping pH using a potassium-nigericin method, and was thus not an artifact. We investigated the mechanism behind these effects, and we could rule out alterations of intrinsic cellular buffer capacity as well as effects on constitutive production of acidic metabolites. Known pH-regulatory mechanisms were systematically studied using specific inhibitors. Alkalinization of the macrophage cytosol is exerted by a Na^+/H^+ -exchanger which is sensitive to amiloride, by a Na^+ -dependent Cl^-/HCO_3^- -exchanger which is sensitive to 4,4'-diisothiocyanatostilbene-2,2'-disulfonic acid (DIDS), and by a H^+ -ATPase which is inhibited by bafilomycin A_1 . Macrophages express an acidifying Na^+ -independent Cl^-/HCO_3^- -exchanger which is also sensitive to DIDS.

We could show the lowering of cytosolic pH by dexamethasone to be attributed to effects on the alkalinizing Na^+ -dependent $\text{Cl}^-/\text{HCO}_3^-$ -exchanger, and on the H^+ -ATPase, which were identified in cells during recovery from acid-loads. We pursued the effects on the H^+ -ATPase further, and we found that dexamethasone did not affect lysosomal pH. Both pools of proton pumps are sensitive to bafilomycin A_1 , but it is not known whether the H^+ -ATPases regulating cytosolic and lysosomal pH are identical. Dexamethasone did not alter the total cellular content of H^+ -ATPase, as assessed by Western blot analysis of the membrane-integral C-subunit. This subunit was also used as a marker in studying the localization of the H^+ -ATPase by means of immunofluorescence. Similar patterns of lysosomal localization were found in dexamethasone- and non-treated cells. The H^+ -ATPase, however, could not be detected in the plasma membrane. This result, together with the finding that recovery of cytosolic pH by the H^+ -ATPase after an acid-load was always preceded by a lag period, pointed out the possibility that cytosolic pH is regulated by H^+ -ATPases located in a vesicular pool. In such a scenario alkalinization could be achieved either through swift appearance of the H^+ -ATPases in the plasma membrane, by vesicular recycling, or through recycling of acidified vesicular contents.

Paper II

Dexamethasone downregulates lysosomal secretion in mouse macrophages: Involvement of signaling through protein kinase C

The objective of this study was to further explain the effects of glucocorticoids on regulated lysosomal secretion. Macrophages were stimulated either by zymosan, which is a particulate preparation from yeast cell walls, or by soluble stimuli and lysosomal secretion, estimated by release of N-acetyl β -D-glucosaminidase. The primary amine MeNH_3 , the ionophore monensin and the inhibitor bafilomycin A_1 causes lysosomal alkalinization and thus triggering of secretion. Lysosomal alkalinization in these cases is caused by accumulation in acidic compartments, by exchange of sodium for protons, and by inhibition of the lysosomal proton pump, respectively. Secretion triggered by zymosan, MeNH_3 and by bafilomycin A_1 were all

inhibited to 60-70% by therapeutic concentrations of dexamethasone. A lesser inhibition was also seen using monensin as secretory stimulus. Since dexamethasone was previously shown to reduce cytosolic pH, we carried out experiments in order to evaluate the role of this reduction for the inhibitory effects seen on lysosomal secretion. In the case of secretion in response to particulate stimuli, we found that zymosan abrogated the reduction of cytosolic pH caused by dexamethasone. Instead, dexamethasone inhibited lysosomal alkalinization, which seems to be plausible explanation of the reduced secretion seen in response to this stimulus. Nor in the case of monensin did the dexamethasone-induced effects on cytosolic pH seem to explain the reduction of secretion. The deviation in base-line cytosolic pH seen with dexamethasone was overridden during treatment with monensin. In the case of MeNH_3 and bafilomycin A_1 , effects on cytosolic pH could still be registered during stimulation, but they were diminished when stimulation was performed in media where pH was more alkaline. On the contrary, the inhibition of secretion was rather enhanced during these conditions. Hence, it could be summarized that dexamethasone did not inhibit lysosomal secretion through alteration of cytosolic pH. This conclusion is further supported by the observation that a near-complete effect on cytosolic pH was seen within 4 h of treatment with dexamethasone, while full effect on secretion required longer incubations. It has been suggested that glucocorticoids alter secretory events through up-regulation of receptors and accelerated re-uptake (Shepherd, Konish et al. 1985). This mechanism was ruled out in our case by measuring secretion of dextrans, which were pre-loaded into lysosomes in a non-receptor-dependent fashion. Inhibition of secretion by dexamethasone was, furthermore, not abrogated by addition of soluble mannan, meant to block receptors, and thus to cause inhibition of enzyme recycling. Instead, we found that activation of PKC, in itself serving as a poor stimulus for secretion, enhanced lysosomal secretion more potently in cells treated with dexamethasone, as compared to non-treated cells, thus reducing the inhibitory effect of the glucocorticoid on lysosomal secretion. Effects on signaling pathways were studied by measuring activation of phospholipase C (PLC) in response to zymosan. PLC activity was measured in cells preloaded with [^3H]inositol. We found a reduction of zymosan-binding in dexamethasone-treated cells. This

could be explained by a change in the cell morphology. Cells treated with dexamethasone will spread less, and thus they will occupy a smaller space. These cells also have fewer dendritic extrusions than did untreated cells do. Differences in cellular binding of zymosan were, however, normalized by customizing the amounts of zymosan used in dexamethasone-treated and non-treated cells. Also, in the latter case was a significant dexamethasone-induced reduction in activation of PLC in response to zymosan observed. We suggest that dexamethasone inhibits lysosomal secretion through interaction with one or more intermediate steps along the signaling axis containing PLC and PKC.

Paper III

Signaling to localized degranulation in neutrophils adherent to immune complexes

Ligation of Fc-receptors on human neutrophils triggers exocytosis of azurophilic and specific granules. In addition to a differential sensitivity to cytosolic levels of Ca^{2+} in the triggering of exocytosis from these granules (Sengeløv, Kjeldsen et al. 1993) it has recently been observed that these exocytotic responses differ also in directionality. Azurophilic granules are released in the vicinity of the sites where IgG-opsonized zymosan particles are attached while specific degranulation seems less localized, occurring all over the plasma membrane (Tapper and Grinstein 1997). The experimental setup in this study was designed to facilitate further elucidation of Fc-receptor-mediated localization of azurophilic degranulation, and also to allow for Western blot analysis of preparations from the degranulation target areas. Neutrophils were adhered to Sepharose beads coated with heat-aggregated IgG, and exocytosis was monitored by immunofluorescence using specific antibodies toward CD63 and CD66b, which are markers for azurophilic and specific granules, respectively. Degranulation was triggered within 60 sec. of adhesion to immune complex-coated Sepharose beads. Adhesion to Sepharose beads allowed accurate high-resolution analysis of degranulation to the adherent plasma membrane using confocal microscopy. In accordance with previous studies on degranulation during phagocytosis of IgG-

opsonized zymosan, azurophilic degranulation during adhesion was confined to the attached section of the plasma membrane, while specific degranulation occurred all over the cell surface. Pharmacological inhibitors were used to investigate signaling pathways involved in immune complex-triggered degranulation. Degranulation was highly sensitive to inhibition of both PKC, using the non-isoform selective inhibitor GF109302X, as well as tyrosine kinases, using genistein and erbstatin. Analysis of cytochalasin B-treated cells showed, in addition, that localized azurophilic degranulation was not dependent on cellular spreading during adhesion. Furthermore, assembly of actin filaments during adhesion, as assessed by rhodamine phalloidin-staining, was never strictly co-localized with degranulation at the adherent plasma membrane. A sonication-technique was used to separate adherent from non-adherent parts of cells. Briefly, adherent neutrophils were treated with a thiol-cleavable protein cross-linker, which made sure that non-adherent parts of the cell could be removed while loss of adherent plasma membranes was prevented. Cross-linked cells were continuously monitored during sonication using the lipophilic dye FM1-43. Presence of signaling molecules was then analyzed by means of Western blotting of adherent and non-adherent samples. Plasma membrane contents in the two fractions were estimated by means of observing pre-biotinylated cell surface molecules as well as by analyzing fraction-content of cell surface molecules pre-labeled with tritiated DIDS. We examined the presence of the tyrosine kinase Syk, and the PKC isoforms, α , β I, δ , and ζ , in adherent and non-adherent fractions, and we normalized the amounts with regard to estimated contents of plasma membrane. These experiments revealed a significant enrichment of Syk, PKC α and β I at the site of adhesion, while PKC δ and ζ did not seem to translocate to this location in particular. The findings regarding sensitivity to pharmacological inhibition and localized translocation render these kinases interesting targets in future studies of localizing signals in neutrophil degranulation.

Paper IV

Regulation of lysosomal pH in macrophages via phosphatidylinositol 3-kinase and protein kinase C

The aim of this study was to investigate mechanisms regulating lysosomal secretion with emphasis on PKC. As addressed in paper II, involvement of PKC in the regulation of exocytotic events has been established in many cell-types including macrophages (Tapper and Sundler 1995c). Since correlation clearly indicates lysosomal alkalinization as a triggering signal in such secretion (Tapper and Sundler 1990), we now focused on the regulation of lysosomal pH, and later we examined the role of PKC in the overall regulation of lysosomal secretion in our accompanying paper (paper V). Exposure of macrophages to zymosan leads to activation of PLC, production of DAG, and to elevation of cytosolic Ca^{2+} (Emilsson and Sundler 1984; Dieter and Fitzke 1993). DAG and Ca^{2+} are both well-known activators of PKC. A recent study indicates that the zymosan-induced activation of PLC in macrophages is at least to some degree regulated downstream of phosphatidylinositol 3-kinase (PI3K) (Hiller, Sternby et al. 2000). Macrophages express PKC α and β , which are two conventional isoforms activated by diacylglycerol and Ca^{2+} , as well as PKC δ and ϵ , which are novel isoforms insensitive to Ca^{2+} , and PKC ζ , which is an atypical isoform sensitive to neither DAG nor Ca^{2+} (Huwiler and Pfeilschifter 1993; Newton 1995).

Lysosomes were loaded with FITC-conjugated dextran through overnight pinocytosis and lysosomal pH was measured in a spectrofluorometer. To ensure that zymosan-induced lysosomal alkalinization was mediated by signaling intermediates, as opposed to phagolysosomal fusion, we also performed measurements of lysosomal pH in the presence of cytochalasin B. This agent, which prevents actin polymerization and thus phagocytosis, did not inhibit zymosan-induced lysosomal alkalinization. We found that the lysosomal alkalinization was reduced in the presence of the phorbol ester, PMA. This effect disappeared after prolonged incubations with PMA, and it correlated with the down-regulation of conventional isoforms of PKC. The effect of acute stimulation with PMA on lysosomal alkalinization was also abrogated by cellular depletion of

Ca²⁺. These findings point out a role for conventional isoforms in the regulation of lysosomal pH. In addition, PMA-induced modulation of lysosomal pH was prevented by inhibition of PI3K by wortmannin. Lysosomes from zymosan-stimulated macrophages were purified using cell-disruption by nitrogen cavitation with subsequent ultracentrifugation in stepwise gradients of Optiprep. Preparations were analyzed on Western blots, and the conventional isoforms α and β were found to co-fractionate with lysosomes in cells stimulated with PMA in addition to zymosan. PMA-induced appearance of these isoforms on lysosomes was prevented by wortmannin. We suggest that conventional isoforms of PKC activated through PI3K are part of a signaling pathway which counteracts zymosan-induced lysosomal alkalinization. These effects could possibly be brought about by PKC-dependent acceleration of lysosomal proton pumps.

Paper V

Modulation of lysosomal secretion by protein kinase C in mouse macrophages

The involvement of PKC in regulation of zymosan-induced lysosomal secretion in mouse peritoneal macrophages was examined using phorbol esters. As shown in the accompanying article (paper IV), activation of conventional isoforms of PKC lead to a reduction in zymosan-induced lysosomal alkalinization. Here we studied the involvement of PKC in regulation of lysosomal secretion, both through perturbation of lysosomal pH, as well as through other mechanisms. Treatment of macrophages with zymosan caused activation of PKC β , δ , and ϵ , as assessed by translocation to a membrane fraction. The time-course for activation of these isoforms was in accordance with onset of zymosan-induced lysosomal secretion. Activation of PKC α was less clear, with a slower and less pronounced translocation. Initially it was found that the PMA-induced reduction of a triggering lysosomal pH was not accompanied by inhibition of lysosomal secretion. As a consequence an additional compensatory modulating mechanism by PMA-activated PKC was revealed. A secretory enhancement by PMA-activated PKC downstream of lysosomal alkalinization was confirmed when

lysosomal secretion was artificially induced through treatment with bafilomycin A₁. This agent bypasses receptor-mediated signaling through inhibition of the vacuolar H⁺-ATPase causing lysosomal alkalinization and secretion. The enhancement of bafilomycin A₁-induced secretion, caused by PMA, was inhibited by the PKC-specific inhibitor GF109203X. In contrast to our previous findings regarding PKC-mediated modulations of lysosomal pH, the PMA-mediated effects on bafilomycin A₁-induced secretion did not respond to inhibition of PI3K by wortmannin. In the case of zymosan-induced secretion, where PMA-induced effects on lysosomal pH and downstream secretion evened up, wortmannin increased the lysosomal secretion by blocking PMA-induced reduction of lysosomal pH, while not interfering with PMA-induced downstream effects on secretion. The downstream enhancement by PMA on bafilomycin A₁-induced secretion subsided with time in accordance with down-regulation of conventional isoforms of PKC. In order to investigate the role of Ca²⁺-sensitive conventional isoforms of PKC in downstream modulation of lysosomal secretion, we performed experiments in cells depleted of Ca²⁺ by the presence of EGTA in the media, with addition of the Ca²⁺-ionophore A23187. Zymosan efficiently triggered lysosomal secretion under these conditions as well. We have previously shown that Ca²⁺-depletion inhibited PMA-mediated reduction of lysosomal alkalinization. Even though depletion of Ca²⁺ restored the zymosan-induced secretion-triggering lysosomal alkalinization, this did not result in an anticipated enhanced secretion through PMA-mediated downstream effects. Effects of Ca²⁺-depletion on PMA-induced translocation of PKC isoforms to membranes were analyzed. Ca²⁺-depletion did not interfere with translocation of novel isoforms. Interestingly, translocation of the conventional isoform α but not β was inhibited under such conditions. Together, these findings indicate a role for PKC β in downstream modulation of lysosomal secretion.

Concluding remarks

Although numerous parallels exist between the regulation of exocytosis in excitable cells and in leukocytes, the paradigms evolved from research on the regulatory role of cytosolic Ca^{2+} in excitable cell degranulation cannot be transferred in a straight forward manner since leukocytes constitute a heterogeneous population, which harbors a heterogeneous set of specialized granules. Information on the role of cytosolic Ca^{2+} in the regulation of degranulation in leukocytes comes from *in vitro* analysis using physiological or artificial stimuli with or without manipulation of cytosolic Ca^{2+} using chelating agents or ionophores. Correlation between elevation of cytosolic Ca^{2+} and leukocyte degranulation is a consistent finding in studies using physiological stimuli such as opsonized particles in macrophages, immune complexes in neutrophils, antigens in basophils, PAF in platelets and TCR-engagement in CTL. The elevation of Ca^{2+} in these cases can be attributed to either an isolated release from intracellular stores or an additional influx through Ca^{2+} -channels from the extracellular pool. Secretion induced by physiological stimuli in cell-types such as eosinophils stimulated by PAF, or CTL and NK-cells through TCR-engagement, is dependent upon the latter response. The secretion is inhibited by the presence of extracellular chelating agents, while degranulation in other leukocytes seems affected only when also the former response is canceled by intracellular chelation of Ca^{2+} through introduction of the acetoxymethyl ester of BAPTA. The requirement for elevation of cytosolic Ca^{2+} in the leukocyte degranulation triggered by physiological stimuli has also been questioned in several cases. Abrogation of Ca^{2+} -mediated signaling by treatment with BAPTA does only partially inhibit degranulation in neutrophils triggered by immune complexes. Exocytosis can be seen in basophils stimulated by antigens without a preceding rise in cytosolic Ca^{2+} . Data contradicting the view of Ca^{2+} as a necessary signal for leukocyte degranulation comes from studies using artificial stimuli as well, where phorbol esters trigger a Ca^{2+} -independent secretion in neutrophils, eosinophils, and in platelets. Secretion is also triggered by $\text{GTP}\gamma\text{S}$ in permeabilized eosinophils without a concomitant elevation of cytosolic Ca^{2+} . As opposed to data concerning requirement for Ca^{2+} in leukocyte degranulation, most of the data on the ability of elevated

Ca^{2+} to induce degranulation come from artificial manipulation of cytosolic Ca^{2+} , with or without activation of parallel signaling pathways. Elevation of cytosolic Ca^{2+} through permeabilization or through introduction of ionophores, triggers degranulation only in certain leukocytes such as neutrophils, basophils, and platelets. A differentiating sensitivity for cytosolic Ca^{2+} among subsets of granules in neutrophils should be regarded, and it has also been found that artificially induced degranulation may require higher concentrations of cytosolic Ca^{2+} than what is achieved by physiological stimuli such as FMLP. Macrophages, monocytes, CTL, and NK-cells, however, respond poorly to artificial elevation of cytosolic Ca^{2+} . Lysosomal secretion induced by zymosan (Tapper and Sundler 1995b, Paper V) in mouse peritoneal macrophages is not inhibited by depletion of cytosolic Ca^{2+} through treatment with EGTA and A23187. Neither is secretion triggered in these cells by elevation of cytosolic Ca^{2+} by A23187 (Paper V).

Various experimental setups have provided evidence of involvement of PKC in the leukocyte degranulation. To begin with, degranulation is triggered in for instance neutrophils, eosinophils, platelets, and monocytes by activation of PKC through treatment with phorbol esters. Such response is on the other hand not seen in RBL 2H3 mast cells or CTL. A second line of evidence of involvement of PKC comes from experiments on permeabilized neutrophils and mast cells where responsiveness to secretory stimuli is lost with time as cytosolic components leak out. A role for phosphorylation is implied, as addition of exogenous ATP restores the loss of secretory responsiveness that occurs with time in these permeabilized systems. Maintenance of ATP-induced responsiveness is further prevented by protein kinase inhibitors. Modulating effects on degranulation from activation and down-regulation of PKC by phorbol esters have also been investigated. A positive regulatory role for PKC in degranulation is often pointed out in such studies. Phorbol esters can for instance enhance degranulation induced by IgE-cross-linking in RBL cells, elevation of Ca^{2+} in platelets and CTL, GTP γ S in platelets, and monensin or MeNH₃ in macrophages. However, a negative modulation by phorbol esters is seen in mast cells stimulated by compound 48/80 and neutrophils stimulated with FMLP or LTB₄. An

inhibitory effect of down-regulation of PKC on degranulation has further been shown in mast cells stimulated with Ca^{2+} and GTP γ S, as well as in macrophages stimulated with zymosan. The role of PKC in leukocyte degranulation has also been studied using inhibitors. Some of these results probably imply a role for phosphorylation events - rather than involvement of PKC - in degranulation, since non-specific inhibitors of PKC such as K252a and staurosporine were often used. It can be mentioned, however, that calphostin C has been shown to inhibit degranulation induced by serum-opsonized particles in eosinophils and adenosine-receptor engagement in NK-cells. Furthermore, degranulation induced by antigen in RBL cells, IgE-cross-linking in basophils, and thrombin in platelets, is sensitive to treatment with the PKC-specific inhibitor Ro 31-7549. Sphingosine, on the other hand, caused an inhibition of IgE-induced degranulation in basophils, while an enhanced degranulation was noted in basophils stimulated with FMLP. It can thus be concluded that substantial evidence from studies including both activators and inhibitors point implies a role for PKC in the modulation of leukocyte degranulation, while the relative importance of this modulation as compared to contributions from other signaling pathways including Ca^{2+} remains to be established. We have found that PKC is a regulator of lysosomal secretion and possibly also a target for anti-inflammatory pharmacological agents (Paper II). This regulation is complex and involves both positive and negative pathways. A negative regulation is exerted at the lysosome, where a secretion-triggering alkalization is inhibited when PKC is activated by PMA. Our data indicate involvement of conventional isoforms in this modulation, as such are found on purified lysosomes from stimulated cells. Effects on lysosomal pH as well as translocation of conventional isoforms to lysosomes were inhibited by wortmannin, also indicating a role for PI3K in the regulation of lysosomal pH. Furthermore, the effects induced by PMA on lysosomal pH were quickly down-regulated in accordance with disappearing conventional isoforms. Finally we found that lowering of lysosomal pH in response to activation of PKC was inhibited by depletion of cytosolic Ca^{2+} , which further indicates the involvement of conventional isoforms in this pathway. It seems interesting that the effects on lysosomal pH were not reflected in the

secretory response, which implies a compensatory positive PKC-dependent pathway acting down-stream of lysosomal pH. This was confirmed by experiments where signaling to lysosomal alkalization was bypassed using bafilomycin A₁. In this case the results from measuring translocation, down-regulation and effects of depletion of cytosolic Ca²⁺ indicate a possible role for PKC β in downstream enhancement of lysosomal secretion.

Further detail regarding the precise roles of PKC in regulating degranulation in different leukocytes is likely to evolve as new approaches develop in the search for specific functions of PKC isoforms. Effects of anti-sense treatment and transfection with PKC isoforms, for instance, on lysosomal secretion, and on other functional responses in monocyte and macrophage cell-lines, have yet to be studied.

Popularized summary in Swedish

(Populärvetenskaplig sammanfattning)

Makrofager återfinns i stort sett överallt i kroppen. De bildas från stamceller i benmärgen och cirkulerar i blodomloppet tillsammans med andra vita blodkroppar i form av monocyter, som kan vandra igenom blodkärlens väggar och vidareutvecklas till makrofager ute i vävnaderna. Makrofagen spelar en viktig roll i kroppens totalförsvar genom att vägleda och orkestrera immunförsvarets övriga celler, t ex genom att producera prostaglandiner och utsöndra cytokiner. Cytokiner är immunförsvarets egna hormoner som verkar såväl lokalt på grannceller som systemiskt via blodbanan. Makrofager har i likhet med vissa andra blodkroppar förmåga att äta (fagocytera) och dricka (pinocytera) av sin omgivning. Därav kommer namnet makrofag som betyder stor ätarcell. En måltid kan bestå av t ex vävnadsvätska, infektiösa mikroorganismer, tumörceller, döda celler och andra vävnadsmaterial. Bakterier kan bindas till makrofagen m h a olika cellytereceptorer. Dessa receptorer aktiverar olika signalsystem inuti cellen. Sådana signaler kan bestå av spridning av vissa joner såsom kalcium eller av en slags kedjereaktion där olika enzymer i tur och ordning påverkar varandra. En sådan påverkan kan bestå av att fosfat fästs vid ett enzym. Sammantaget kan dessa signalsystem, som för övrigt ofta interagerar inbördes på ett komplext sätt, ses som cellens sätt att tänka och är därmed avgörande för dess handling. Bakterier och svamporganismer som fastnar på makrofagens receptorer aktiverar signalsystem som leder till att de fagocyteras. Väl inne i cellen sammansmälter dessa fagosomer med lysosomer. Lysosomen är en membranomsluten behållare som kan ses som cellens soptipp eller snarare som cellens återvinningscentral. Här finns en stor uppsättning nedbrytande enzymer som fungerar bäst i en sur miljö. Till skillnad från den neutrala cellvätskan har lysosomerna ett pH-värde under 5, som bibehålles av speciella protonpumpar belägna i lysosommembranet. Tyvärr kan vissa bakteriefamiljer överleva inuti makrofager t ex genom att se till så att lysosomen blir mer basisk eller genom att helt enkelt undvika att hamna i lysosomen. Parallellt med bekämpning av t ex bakterier inuti cellen sker en utsöndring av lysosomala enzymer ut ur cellen. Syftet med detta tror man vara att

åstadkomma bekämpning av bakterier i cellens omgivning samt att bryta ner vävnad för att underlätta uppremsning och återuppbyggnad i inflammatorisk vävnad. Dessvärre kan sådan sekretion av lysosomala enzymer eventuellt bidra till bestående vävnadsskador vid långvariga inflammatoriska tillstånd som ses t ex vid autoimmuna sjukdomar. Syftet med denna avhandling är att belysa hur olika signalsystem inuti makrofagen påverkar utsöndringen av lysosomala enzymer. Till skillnad från i många andra celltyper, där en ökning av kalciumjoner i cellvätskan sätter igång sekretionen, så verkar aktivering av makrofager i stället leda till att dess lysosomer blir mer basiska, vilket i sin tur leder till att den lysosomala sekretionen sätts igång. Alkalinisering av lysosomer styrs bl a av de två olika enzymerna fosfatidylinositol 3-kinas och proteinkinase C. Kinas betecknar här att de vidarebefordrar signaler genom att koppla fosfatgrupper på lipider respektive proteiner. Proteinkinase C har utöver en reglerande funktion på lysosomalt pH även en pH-oberoende förstärkande effekt på den lysosomala sekretionen i makrofager.

Acknowledgements

First of all I would like to express my deep and sincere gratitude to my mentor and supervisor, Professor Roger Sundler, who has let me share his knowledge and his time, provided me with space and money to do my work, and offered me his friendship throughout these years. Roger, I hope that your sound attitude to science, and to life in general, has made a print in me which lasts forever.

I also want to thank two of Roger's earlier disciples, Hans Tapper and Jonny Wikander. These two oldboys have given me lots of day-by-day guidance, encouragement, not to mention the good laughs which can turn a miserable situation into a dear memory.

I am grateful for having met Gösta Hiller, who has become a dear friend also in my private life. It was he who introduced me to two other dentist-not-wannabees, namely Jonathan Moses and Claes Wickström. Thanks to you for sharing delicate philosophies as well as cruder jokes with me. I think we've had lots of fun together.

I want to thank Pia Lundquist for being a great person, as well as for helping with my experiments. I also thank Karin Gewert, a colleague, for her friendship. My thanks to Karolina Andersson and Sandra Ullberg for creating a cheerful atmosphere in the lab.

I want to thank my parents, Christina and Tadde, for always being there for me. I love you both, and I know I should have told you so more often. And thanks to my brother Johan, I should have told you too more often how much I look up to you.

And thanks to you Elisabeth, my love. Without your patience and support this work wouldn't ever have been finished. You made me endure, and you gave me Gustav. I hope I can make it up to you some day.

References

- Ackerman, N. R., J. R. Beebe and G. Schidlovsky (1977) *Cytobios.* **20**(77): 7-20
- Aizawa, T., Y. Kakuta, K. Yamauchi, Y. Ohkawara, N. Maruyama, Y. Nitta, G. Tamura, H. Sasaki and T. Takishima (1992) *J. Allergy Clin. Immunol.* **90**(5): 789-795
- Alfonso, A., A. G. Cabado, M. R. Vieytes and L. M. Botana (2000) *Br. J. Pharmacol.* **130**(8): 1809-1816
- Allen, L.-A. H. and A. Aderem (1995) *J. Exp. Med.* **182**: 829-840
- Almholt, K., P. O. Arkhammar, O. Thastrup and S. Tullin (1999) *Biochem. J.* **337** (Pt 2): 211-218
- Andrews, N. W. (2000) *Trends Cell Biol.* **10**: 316-321
- Areces, L. B., M. G. Kazanietz and P. M. Blumberg (1994) *J. Biol. Chem.* **269**(30): 19553-19558
- Asherson, G. L. and V. Colizzi (1991) Antigen presentation. Human monocytes, M. Zembala and G. L. Asherson. London, Academic Press
- Atkinson, E. A., J. M. Gerrard, G. E. Hildes and A. H. Greenberg (1990) *J. Leukoc. Biol.* **47**(1): 39-48
- Aunis, D. and M. F. Bader (1988) *J. Exp. Biol.* **139**: 253-266
- Bacher, N., Y. Zisman, E. Berent and E. Livneh (1991) *Mol. Cell Biol.* **11**(1): 126-133
- Badwey, J. A., R. W. Erickson and J. T. Curnutte (1991) *Biochem. Biophys. Res. Commun.* **178**(2): 423-429
- Baier, G., D. Telford, L. Giampa, K. M. Coggeshall, G. Baier-Bitterlich, N. Isakov and A. Altman (1993) *J. Biol. Chem.* **268**(7): 4997-5004
- Balazovich, K. J., J. E. Smolen and L. A. Boxer (1986) *Blood* **68**(4): 810-817
- Bank, U. and S. Ansorge (2001) *J. Leukoc. Biol.* **69**(2): 197-206
- Barker, S. A., D. Lujan, and B. S. Wilson (1999) *J. Leukoc. Biol.* **65**: 321-329
- Barrowman, M. M., Cockcroft, S. and B. D. Gomperts (1987) *J. Physiol.* **383**: 115-124
- Bassini, A., G. Zauli, G. Migliaccio, A. R. Migliaccio, M. Pascuccio, S. Pierpaoli, L. Guidotti, S. Capitani and M. Vitale (1999) *Blood* **93**(4): 1178-1188

- Bates, M. E., P. J. Bertics, W. J. Calhoun and W. W. Busse (1993) *J. Immunol.* **150**(10): 4486-4493
- Bazzi, M. D. and G. L. Nelsestuen (1987) *Biochemistry* **26**(1): 115-122
- Beaven, M. A., D. F. Guthrie, J. P. Moore, G. A. Smith, T. R. Hesketh and J. C. Metcalfe (1987) *J. Cell Biol.* **105**(3): 1129-1136
- Bell, M. B., and D. J. Burns (1991) *J. Biol. Chem.* **266**: 4661-4664
- Beltman, J., F. McCormick and S. J. Cook (1996) *J. Biol. Chem.* **271**(43): 27018-27024
- Berggren, P. O. and O. Larsson (1994) *Biochem. Soc. Trans.* **22**(1): 12-18
- Bergstrand, H., B. Lundquist, K. Karabelas and P. Michelsen (1992) *J. Pharm. Exp. Ther.* **260**(3): 1028-1037
- Berke, G. (1994) *Annu. Rev. Immunol.* **12**: 735-773
- Berkow, R. L., R. W. Dodson and A. S. Kraft (1987) *J. Leukoc. Biol.* **41**(5): 441-446
- Bidani, A., S. E. Brown and T. A. Heming (1994) *Am. J. Physiol.* **266**(6 Pt 1): L681-L688
- Bidani, A. and T. A. Heming (1995) *J. Leukoc. Biol.* **57**(2): 275-281
- Billiard, J., D. S. Koh, D. F. Babcock and B. Hille (1997) *Proc. Natl. Acad. Sci. U S A* **94**(22): 12192-12197
- Bit, R. A., P. D. Davis, et al. (1993) *J. Med. Chem.* **36**(1): 21-29
- Blackwell, G. J., R. W. Bonser, J. Dawson and L. G. Garland (1985) *Biochem. Biophys. Res. Commun.* **127**(3): 950-955
- Blanchard, D., J. P. Aubry, J. E. de Vries and H. Spits (1989) *J. Immunol.* **142**(7): 2173-2180
- Blasi, J., T. Binz, S. Yamasaki, E. Link, H. Niemann and R. Jahn (1994) *J. Physiol. Paris* **88**(4): 235-241
- Blocker, A., F. F. Severin, J. K. Burkhardt, J. B. Bingham, H. Yu, J. C. Olivo, T. A. Schroer, A. A. Hyman and G. Griffiths (1997) *J. Cell Biol.* **137**: 113-129
- Blocker, A., F. F. Severin, A. Habermann, A. A. Hyman, G. Griffiths and J. K. Burkhardt (1996) *J. Biol. Chem.* **271**(7): 3803-3811
- Bock, J. B. and R. H. Scheller (1997) *Nature* **387**(6629): 133-135
- Bogwald, J., E. Johnson, J. Hoffman and R. Seljelid (1984) *J. Leukoc. Biol.* **35**(4): 357-371

- Bonnema, J. D., L. M. Karnitz, R. A. Schoon, R. T. Abraham and P. J. Leibson (1994) *J. Exp. Med.* **180**(4): 1427-1435
- Bonnema, J. D., K. A. Rivlin, A. T. Ting, R. A. Schoon, R. T. Abraham and P. J. Leibson (1994) *J. Immunol.* **152**(5): 2098-2104
- Bonney, R. J., P. D. Wightman, M. E. Dahlgren, P. Davies, F. A. Kuehl, Jr. and J. L. Humes (1980) *Biochim. Biophys. Acta.* **633**(3): 410-421
- Boonen, G. J., J. van Steveninck, T. M. Dubbelman, P. J. van den Broek and J. G. Elferink (1992) *Biochem. J.* **287 (Pt 3)**: 695-700
- Borner, C., I. Filipuzzi, M. Wartmann, U. Eppenberger and D. Fabbro (1989) *J. Biol. Chem.* **264**(23): 13902-13909
- Borregaard, N., K. Lollike, L. Kjeldsen, H. Sengeløv, L. Bastholm, M. H. Nielsen and D. F. Bainton (1993) *Eur. J. Haematol.* **51**: 187-198
- Bronner, C., A. Valle, J. P. Gies and Y. Landry (1986) *Ann. Inst. Pasteur. Immunologie* **137D**(2): 249-261
- Brumell, J. H., A. Volchuk, H. Sengelov, N. Borregaard, A. M. Cieutat, D. F. Bainton, S. Grinstein and A. Klip (1995) *J. Immunol.* **155**(12): 5750-5759
- Bruns, R. F., F. D. Miller, R. L. Merriman, J. J. Howbert, W. F. Heath, E. Kobayashi, I. Takahashi, T. Tamaoki and H. Nakano (1991) *Biochem. Biophys. Res. Commun.* **176**(1): 288-293
- Burgoyne, R. D. and A. Morgan (1995) *Trends Neurosci.* **18**: 191-196
- Burns, D. J. and R. M. Bell (1991) *J. Biol. Chem.* **266**(27): 18330-18338
- Butor, C., G. Griffiths, N. N. Aronson Jr and A. Varki (1995) *J. Cell Science* **108**: 2213-2219
- Cabanis, A., B. Gressier, C. Brunet, T. Dine, M. Luyckx, M. Cazin and J. C. Cazin (1996) *Gen. Pharmacol.* **27**(8): 1409-1414
- Capodici, C., Hanft, S., Feoktsov, M., and M. H. Pillinger (1998) *J. Immunol.* **160**: 1901-1909
- Cardella, C. J., P. Davies and A. C. Allison (1974) *Nature* **247**(435): 46-48
- Chakravarty, N., B. Kjeldsen, M. Hansen and E. H. Nielsen (1990) *Exp. Cell Res.* **186**(2): 245-249
- Chang, J. P., J. Graeter and K. J. Catt (1986) *Biochem. Biophys. Res. Commun.* **134**(1): 134-139
- Cheek, T. R. and V. A. Barry (1993) *J. Exp. Biol.* **184**: 183-196

- Chen, C. C., J. K. Wang and S. B. Lin (1998) *J. Immunol.* **161**(11): 6206-6214
- Christiansen, N. O. and N. Borregaard (1989) *Scand. J. Immunol.* **29**(4): 409-416
- Churcher, Y., K. M. Kramer and B. D. Gomperts (1990) *Cell Regul.* **1**(7): 523-530
- Cieutat, A. M., P. Lobel, J. T. August, L. Kjeldsen, H. Sengelov, N. Borregaard and D. F. Bainton (1998) *Blood* **91**(3): 1044-1058
- Claus, V., A. Jahraus, T. Tjelle, T. Berg, H. Kirschke, H. Faulstich and G. Griffiths (1998) *J. Biol. Chem.* **273**(16): 9842-9851
- Cockcroft, S., T. W. Howell and B. D. Gomperts (1987) *J. Cell Biol.* **105**(6 Pt 1): 2745-2750
- Cockcroft, S., and M. A. De Matteis (2001) *J. Membrane Biol.* **180**: 187-194
- Conboy, I. M., D. Manoli, V. Mhaiskar and P. P. Jones (1999) *Proc. Natl. Acad. Sci. U S A* **96**(11): 6324-6329
- Coorsen, J. R., M. M. Davidson and R. J. Haslam (1990) *Cell Regul.* **1**(13): 1027-1041
- Corbalán-García, S., J. A. Rodríguez-Alfaro and J. C. Gómez-Fernández (1999) *Biochem. J.* **337** (Pt 3): 513-521
- Corvera, S., and M. P. Czech (1998) *Trends Cell Biol.* **8**: 442-446
- Cosson, P., I. de Curtis, J. Pouyssegur, G. Griffiths and J. Davoust (1989) *J. Cell. Biol.* **108**(2): 377-387
- Crofton, R. W., M. M. Diesselhoff-den Dulk and R. van Furth (1978) *J. Exp. Med.* **148**(1): 1-17
- Cromwell, O., J. P. Bennett, I. Hide, A. B. Kay and B. D. Gomperts (1991) *J. Immunol.* **147**(6): 1905-1911
- Dahlgren, C., S. R. Carlsson, A. Karlsson, H. Lundqvist and C. Sjölin (1995) *Biochem. J.* **311**: 667-674
- Dan-Cohen, H. and Z. Naor (1990) *Mol. Cell. Endocrinol.* **69**(2-3): 135-144
- Dang, P. M., J. Hakim and A. Perianin (1994) *FEBS Lett.* **349**(3): 338-342
- Dang, P. M.-D., S. Rais, J. Hakim and A. Perianin (1995) *Biochem. Biophys. Res. Comm.* **212**(2): 664-672
- Davies, E. V. and M. B. Hallett (1998) *Biochem. Biophys. Res. Commun.* **248**(3): 679-683

- Davies, P. and A. C. Allison (1976) *Agents Actions* **6**(1-3): 60-74.
- Davies, P. and R. J. Bonney (1980) The secretion of hydrolytic enzymes by mononuclear phagocytes. *The Cell Biology of Inflammation*. G. Weissmann. Amsterdam, Elsevier/North-Holland Biomedical Press: 497-542
- Davis, P. D., L. H. Elliott, et al. (1992) *J. Med. Chem.* **35**(6): 994-1001
- Davis, P. D., C. H. Hill, G. Lawton, J. S. Nixon, S. E. Wilkinson, S. A. Hurst, E. Keech and S. E. Turner (1992) *J. Med. Chem.* **35**(1): 177-184
- Dean, R. T., W. Hylton and A. C. Allison (1979a) *Biochim. Biophys. Acta* **584**(1): 57-65
- Dean, R. T., W. Hylton and A. C. Allison (1979b) *Exp. Cell. Biol.* **47**(6): 454-462
- Dekker, L. V. and P. J. Parker (1994) *Trends Biochem. Sci.* **19**(2): 73-77
- Dell'Angelica, E. C., Mullins, C., Caplan, S. and J. S. Bonifacino (2000) *Faseb J.* **14**(10): 1265-1278
- Desjardins, M. (1995) *Trends Cell Biol.* **5**(Maj): 183-186
- Dewald, B., M. Thelen, M. P. Wymann and M. Baggiolini (1989) *Biochem. J.* **264**(3): 879-884
- Devalia, V., N. S. Thomas, P. J. Roberts, H. M. Jones and D. C. Linch (1992) *Blood* **80**(1): 68-76
- Di Carlo, F. J. and J. V. Fiore (1957) *Science* **127**: 756-757
- Di Virgilio, F. and B. D. Gomperts (1983) *Biochim. Biophys. Acta* **763**(3): 292-298
- Di Virgilio, F., D. P. Lew and T. Pozzan (1984) *Nature* **310**(5979): 691-693
- Di Virgilio, F., B. C. Meyer, S. Greenberg and S. C. Silverstein (1988) *J. Cell. Biol.* **106**(3): 657-666
- Dieter, P. and E. Fitzke (1993) *Eur. J. Biochem.* **218**: 753-758
- Dieter, P., A. Schulze-Specking and K. Decker (1988) *J. Hepatol.* **6**(2): 167-174
- Djouder, N., Schmidt, G., Frings, M., Cavalié, A., Thelen, M., and K. Aktories (2001) *J. Immunol.* **166**: 1627-1634
- Dröse, S., K. U. Bindsell, E. J. Bowman, A. Siebers, A. Zeeck and K. Altendorf (1993) *Biochemistry* **32**: 3902-3906

- Dutz, J. P., D. A. Fruman, S. J. Burakoff and B. E. Bierer (1993) *J. Immunol.* **150**(7): 2591-2598
- Egesten, A., U. Gullberg, I. Olsson and J. Richter (1993) *J. Leukoc. Biol.* **53**(3): 287-293
- Egesten, A. and J. Malm (1998) *Allergy* **53**(11): 1066-1073
- Egesten, A., Calafat, J., Janssen, H., Knol, E. F., Malm, J. and T. Persson (2001) *Clin. Exp. Allergy* **31**: 1173-1188
- Eichholtz, T., D. B. de Bont, J. de Widt, R. M. Liskamp and H. L. Ploegh (1993) *J. Biol. Chem.* **268**(3): 1982-1986
- Elliott, L. H., S. E. Wilkinson, A. D. Sedgwick, C. H. Hill, G. Lawton, P. D. Davis and J. S. Nixon (1990) *Biochem. Biophys. Res. Commun.* **171**(1): 148-154
- Elzagallaai, A., S. D. Rose and J. M. Trifaro (2000) *Blood* **95**(3): 894-902
- Emilsson, A. and R. Sundler (1984) *J. Biol. Chem.* **259**(5): 3111-3116
- Esaguy, N., A. P. Aguas, M. Vilanova and M. T. Silva (1991) *J. Leukoc. Biol.* **50**(5): 444-452
- Evans, D. J., M. A. Lindsay, B. L. Webb, H. Kankaanranta, M. A. Giembycz, B. J. O'Connor and P. J. Barnes (1999) *Am. J. Physiol.* **277**(2 Pt 1): L233-239
- Fabre, S., M. Prudhomme and M. Rapp (1993) *Bioorg. Med. Chem.* **1**(3): 193-196
- Fallon, R. J. (1990) *Biochem. Biophys. Res. Commun.* **170**(3): 1191-1196
- Fittschen, C. and P. M. Henson (1994) *J. Clin. Invest.* **93**(1): 247-255
- Fortier, A. H., C. A. Nancy and M. V. Sitkovsky (1989) *Cell. Immunol.* **124**(1): 64-76
- Fujihara, M., N. Connolly, N. Ito and T. Suzuki (1994) *J. Immunol.* **152**(4): 1898-1906
- Fujita, I., K. Irita, K. Takeshige and S. Minakami (1984) *Biochem. Biophys. Res. Commun.* **120**(2): 318-324
- Fujita, Y., T. Sasaki, K. Fukui, H. Kotani, T. Kimura, Y. Hata, T. C. Sudhof, R. H. Scheller and Y. Takai (1996) *J. Biol. Chem.* **271**(13): 7265-7268
- Fukuda, T., S. J. Ackerman, C. E. Reed, M. S. Peters, S. L. Dunnette and G. J. Gleich (1985) *J. Immunol.* **135**(2): 1349-1356

Gallin, J. I., I. M. Goldstein and R. Snyderman (1992) *Inflammation. Basic principles and clinical correlates*. New York, Raven Press.

Garcia-Paramio, P., Y. Cabrerizo, F. Bornancin and P. J. Parker (1998) *Biochem. J.* **333** (Pt 3): 631-636

Gat-Yablonski, G. and R. Sagi-Eisenberg (1990) *Biochem. J.* **270**(3): 679-684

Geiges, D., T. Meyer, B. Marte, M. Vanek, G. Weissgerber, S. Stabel, J. Pheilschifter, D. Fabbro and A. Huwiler (1997) *Biochem. Pharm.* **53**: 865-875

Gillooly, D. J., Simonsen, A., and H. Stenmark (2001) *Biochem. J.* **355**: 249-258

Gleich, G. J., C. R. Adolphson and K. M. Leifman (1992) Eosinophils. *Inflammation. Basic Principles and Clinical Correlates*. J. I. Gallin, I. M. Goldstein and R. Snyderman. New York, Raven Press: 663-700

Gopalakrishna, R., Z. H. Chen and U. Gundimeda (1992) *FEBS Lett.* **314**(2): 149-154

Gordon, J. L., D. E. MacIntyre and R. M. McMillan (1977) *Br. J. Pharmacol.* **61**(3): 452P-453P

Gordon, S., S. Keshav and L. P. Chung (1988) *Curr. Opin. Immunol.* **1**(1): 26-35

Gordon, S., J. Todd and Z. A. Cohn (1974) *J. Exp. Med.* **139**(5): 1228-1248

Gottlieb, R. A., H. A. Giesing, J. Y. Zhu, R. L. Engler and B. M. Babior (1995) *Proc. Natl. Acad. Sci. U S A* **92**(13): 5965-5968

Grabarek, J. and A. Ware (1993) *J. Biol. Chem.* **268**: 5543-5549

Gray, L. S., J. R. Gnarra and V. H. Engelhard (1987) *J. Immunol.* **138**(1): 63-69

Gray, L. S., J. R. Gnarra, J. A. Sullivan, G. L. Mandell and V. H. Engelhard (1988) *J. Immunol.* **141**(7): 2424-2430

Gschwendt, M., G. Fürstenberger, et al. (1995) *Carcinogenesis* **16**(1): 107-111

Gschwendt, M., W. Kittstein and F. Marks (1994) *FEBS Lett.* **338**(1): 85-88

Hackam, D. J., O. D. Rotstein, M. K. Bennett, A. Klip, S. Grinstein and M. F. Manolson (1996) *J. Immunol.* **156**(11): 4377-4383

Hannun, Y. A., C. R. Loomis, A. H. Merrill, Jr. and R. M. Bell (1986) *J. Biol. Chem.* **261**(27): 12604-12609

- Hashimoto, Y., T. Nakayama, et al. (1991) *Biochem. Biophys. Res. Commun.* **181**(1): 423-429
- Hashimoto, Y., M. Togo, K. Tsukamoto, Y. Horie, T. Watanabe and K. Kurokawa (1994) *Biochim. Biophys. Acta* **1222**(1): 56-62
- Haslam, R. J. and J. R. Coorsen (1993) *Adv. Exp. Med. Biol.* **344**: 149-164
- Haslam, R. J. and M. M. Davidson (1984) *FEBS Lett.* **174**(1): 90-95
- Haverstick, D. M., V. H. Engelhard and L. S. Gray (1991) *J. Immunol.* **146**(10): 3306-3313
- Heidelberger, R. and G. Matthews (1994) *Neuroreport* **5**(6): 729-732
- Heiman, A. S. and F. T. Crews (1985) *J. Immunol.* **134**(1): 548-555
- Henquin, J. C. (2000) *Diabetes* **49**(11): 1751-1760
- Henquin, J. C., J. C. Jonas and P. Gilon (1998) *Diabetes Metab.* **24**(1): 30-36
- Henson, P. M., Henson, J. E., Fittschen, C., Kimani, G., Bratton, D. L. and D. W. H. Riches (1992) Phagocytic cells: Degranulation and secretion. *Inflammation. Basic Principles and Clinical Correlates.* J. I. Gallin, I. M. Goldstein and R. Snyderman. New York, Raven Press: 511-539
- Herbert, J. M., E. Seban and J. P. Maffrand (1990) *Biochem. Biophys. Res. Commun.* **171**(1): 189-195
- Hibbs, J. B., Jr., R. R. Taintor and Z. Vavrin (1987) *Science* **235**(4787): 473-476
- Hidaka, H., M. Inagaki, S. Kawamoto and Y. Sasaki (1984) *Biochemistry* **23**(21): 5036-5041
- Hii, C. S. T., Marin, L. A., Halliday, D., Robertson, D. M., Murray, A. W., and A. Ferrante (2001) *Immunol.* **102**: 59-66
- Hilfiker, S., V. A. Pieribone, C. Nordstedt, P. Greengard and A. J. Czernik (1999) *J. Neurochem.* **73**(3): 921-932
- Hille, B., J. Billiard, D. F. Babcock, T. Nguyen and D. S. Koh (1999) *J. Physiol.* **520**(Pt 1): 23-31
- Hiller, G., M. Sternby, R. Sundler and J. Wijkander (2000) *Biochim. Biophys. Acta* **1485**: 163-172
- Hirasawa, N., Sato, Y., Yomogida, S., Mue, S., and K. Ohuchi (1997) *Cell. Signal.* **9**(3/4): 305-310
- Ho, J. L. and M. S. Klempner (1985) *J. Infect. Dis.* **152**(5): 922-929

- Ho, J. L. and M. S. Klempner (1986) *Biochem. Biophys. Res. Commun.* **135**(1): 16-24
- Holevinsky, K. O. and D. J. Nelson (1998) *Biophys. J.* **75**(5): 2577-2586
- Hollenbeck, P. J. and J. A. Swanson (1990) *Nature* **346**(6287): 864-866.
- Hong-Geller, E. and R. A. Cerione (2000) *J. Cell. Biol.* **148**(3): 481-494
- House, C. and B. E. Kemp (1987) *Science* **238**(4834): 1726-1728.
- Howell, T. W., S. Cockcroft and B. D. Gomperts (1987) *J. Cell. Biol.* **105**(1): 191-197
- Hug, H. and T. F. Sarre (1993) *Biochem. J.* **291**(Pt 2): 329-343
- Huwiler, A., D. Fabro and J. Pfeilschifter (1994) *Biochem. Pharm.* **48**: 689-700
- Huwiler, A. and J. Pfeilschifter (1993) *Eur. J. Biochem.* **217**: 69-75
- Iikura, M., Yamaguchi, M., Miyamasu, M., Morita, Y., Iwase, T., Moro, I., Yamamoto, K., and K. Hirai (1999) *Biochem. Biophys. Res. Comm.* **264**: 575-579
- Israels, S. J., P. Robinson, J. C. Docherty and J. M. Gerrard (1985) *Thromb. Res.* **40**(4): 499-509
- Johnson, J. A., M. O. Gray, C. H. Chen and D. Mochly-Rosen (1996) *J. Biol. Chem.* **271**(40): 24962-24966
- Jones, T., C. Courage, A. Hubbard and A. Gescher (1997) *Biochem. Pharmacol.* **53**(10): 1413-1418
- Kang, D., H. Tsuda, K. Takeshige, Y. Shibata and S. Minakami (1985) *J. Biochem.* **98**(6): 1699-1706
- Karimi, K. and M. R. Lennartz (1995) *J. Immunol.* **155**(12): 5786-5794
- Karlsson, A., Nixon, J. B., and L. C. McPhail (2000) *J. Leukoc. Biol.* **67**: 396-404
- Kase, H., K. Iwahashi, S. Nakanishi, Y. Matsuda, K. Yamada, M. Takahashi, C. Murakata, A. Sato and M. Kaneko (1987) *Biochem. Biophys. Res. Commun.* **142**(2): 436-440
- Kataoka, T. and K. Nagai (2000) *Immunol. Lett.* **72**(1): 49-52
- Kato, M., R. T. Abraham and H. Kita (1995) *J. Immunol.* **155**: 357-366

- Keenan, C., A. Long and D. Kelleher (1997) *Biochim. Biophys. Acta* **1358**(2): 113-126
- Kelly, B. A. and R. A. Carchman (1987) *J. Biol. Chem.* **262**(36): 17404-17411
- Kent, J. D., S. Sergeant, D. J. Burns and L. C. McPhail (1996) *J. Immunol.* **157**(10): 4641-4647
- Keranen, L. M., E. M. Dutil and A. C. Newton (1995) *Curr. Biol.* **5**(12): 1394-1403
- Kernen, P., M. P. Wymann, V. von Tscharner, D. A. Deranleau, P. C. Tai, C. J. Spry, C. A. Dahinden and M. Baggiolini (1991) *J. Clin. Invest.* **87**(6): 2012-2017
- Kiley, S. C., S. Jaken, R. Whelan and P. J. Parker (1995) *Biochem. Soc. Trans.* **23**(3): 601-605
- Kiley, S. C., P. J. Parker, D. Fabbro and S. Jaken (1992) *Carcinogen.* **13**(11): 1997-2001
- Kita, H., M. Kato, G. J. Gleich and R. T. Abraham (1994) *J. Allergy Clin. Immunol.* **94**: 1272-1281
- Klempner, M. S. and B. Styrt (1983) *J. Clin. Invest.* **72**(5): 1793-1800
- Knight, D. E. and M. C. Scrutton (1985) *FEBS Lett.* **183**(2): 417-422
- Knight, D. E. and M. C. Scrutton (1986) *Eur. J. Biochem.* **160**(1): 183-190
- Knusel, B. and F. Hefti (1992) *J. Neurochem.* **59**(6): 1987-1996
- Ko, F. N., I. S. Chen, S. J. Wu, L. G. Lee, T. F. Haung and C. M. Teng (1990) *Biochim. Biophys. Acta* **1052**(3): 360-365
- Kobayashi, E., H. Nakano, M. Morimoto and T. Tamaoki (1989) *Biochem. Biophys. Res. Commun.* **159**(2): 548-553
- Kobayashi, I. and M. Ziff (1975) *Arthritis Rheum.* **18**(5): 475-483
- Koopmann, W. R. and R. C. Jackson (1990) *Biochem. J.* **265**(2): 365-373
- Korchak, H. M., M. W. Rossi and L. E. Kilpatrick (1998) *J. Biol. Chem.* **273**(42): 27292-27299
- Korchak, H. M. and G. Weissmann (1980) *Biochim. Biophys. Acta* **601**(1): 180-194
- Kornfeld, S. and I. Mellman (1989) *Ann. Rev. Cell Biol.* **5**: 483-525
- Krane, S. M., W. Conca, M. L. Stephenson, E. P. Amento and M. B. Goldring (1990) *Ann. N. Y. Acad. Sci.* **580**: 340-354

- Kroegel, C., E. R. Chilvers, M. A. Giembycz, R. A. Challiss and P. J. Barnes (1991) *J. Allergy Clin. Immunol.* **88**(1): 114-124
- Kroegel, C., R. Pleass, T. Yukawa, K. F. Chung, J. Westwick and P. J. Barnes (1989) *FEBS Lett.* **243**(1): 41-46
- Kroegel, C., T. Yukawa, G. Dent, P. Chanez, K. F. Chung and P. J. Barnes (1988) *Immunol.* **64**(3): 559-561
- Kroegel, C., T. Yukawa, G. Dent, P. Venge, K. F. Chung and P. J. Barnes (1989a) *J. Immunol.* **142**(10): 3518-3526
- Kroegel, C., T. Yukawa, J. Westwick and P. J. Barnes (1989b) *Biochem. Biophys. Res. Commun.* **162**(1): 511-521
- Ku, W. C., A. J. Cheng and T. C. Wang (1997) *Biochem. Biophys. Res. Commun.* **241**(3): 730-736
- Lancki, D. W., B. P. Kaper and F. W. Fitch (1989) *J. Immunol.* **142**(2): 416-424
- Larbi, K. Y. and B. D. Gomperts (1997) *Cell Calcium* **21**(3): 213-219.
- Lardner, A. (2001) *J. Leukoc. Biol.* **69**(4): 522-530
- Larsen, E. C., J. A. DiGennaro, N. Saito, S. Mehta, D. J. Loegering, J. E. Mazurkiewicz and M. R. Lennartz (2000) *J. Immunol.* **165**(5): 2809-2817
- Lee, H.-W., L. Smith, G. R. Pettit, A. Vinitsky and J. Bingham Smith (1996) *J. Biol. Chem.* **271**: 20973-20976
- Lennartz, M. R. (1999) *Int. J. Biochem. Cell Biol.* **31**: 415-430
- Leoni, P. and R. T. Dean (1983a) *Biochim. Biophys. Acta* **762**(3): 378-389
- Leoni, P. and R. T. Dean (1983b) *Exp. Cell Biol.* **51**(3): 148-157
- Lew, D. P., Monod, A., Waldvogel, F. A., Dewald, B., Baggiolini, M. and T. Pozzan (1986) *J. Cell Biol.*, **102**: 2197-2204
- Lian, J. P., S. Stone, Y. Jiang, P. Lyons and S. Ferro-Novick (1994) *Nature* **372**(6507): 698-701
- Lillie, T. H. and B. D. Gomperts (1992) *Biochem. J.* **288**(Pt 1): 181-187
- Lillie, T. H., T. D. Whalley and B. D. Gomperts (1991) *Biochim. Biophys. Acta* **1094**(3): 355-363
- Lin, S. X. and C. A. Collins (1992) *J. Cell Sci.* **101**(Pt 1): 125-137
- Lin, W. W. and B. C. Chen (1998) *Br. J. Pharmacol.* **125**(7): 1601-1609
- Liu, J. P. (1997) *Clin. Exp. Pharmacol. Physiol.* **24**(8): 611-618

- Lloyd, E. D. and M. W. Wooten (1992) *J. Neurochem.* **59**(3): 1099-1109
- Luo, J-H., and I. B. Weinstein (1993) *J. Biol. Chem.* **268**: 23580-23584
- Lupashin, V. V. and M. G. Waters (1997) *Science* **276**(5316): 1255-1258
- Madshus, I. H. (1988) *Biochem. J.* **250**(1): 1-8
- Mahomed, A. G. and R. Anderson (2000) *Inflammation* **24**(6): 559-569
- Majumdar, S., L. H. Kane, M. W. Rossi, B. D. Volpp, W. M. Nauseef and H. M. Korchak (1993) *Biochim. Biophys. Acta* **1176**(3): 276-286
- Majumdar, S., M. W. Rossi, et al. (1991) *J. Biol. Chem.* **266**(14): 9285-9294
- Malenka, R. C., D. V. Madison and R. A. Nicoll (1986) *Nature* **321**(6066): 175-177
- Marche, P., F. Rendu, J. Maclouf, A. Girard and S. Levy-Toledano (1985) *J. Cardiovasc. Pharmacol.* **7**(Suppl 7): S18-19
- Marquardt, D. L., Alongi, J. L., and L. L. Walker (1996) *J. Immunol.* **156**: 1942-1945
- Martiny-Baron, G., M. G. Kazanietz, H. Mischak, P. M. Blumberg, G. Kochs, H. Hug, D. Marme and C. Schachtele (1993) *J. Biol. Chem.* **268**(13): 9194-9197
- McCarthy, K., R. A. Musson and P. M. Henson (1982) *J. Reticuloendothel. Soc.* **31**(2): 131-144
- McMillan, R. M., D. E. Macintyre, J. E. Beesley and J. L. Gordon (1980) *J. Cell Sci.* **44**: 299-315
- Meir, A., S. Ginsburg, A. Butkevich, S. G. Kachalsky, I. Kaiserman, R. Ahdut, S. Demirgoren and R. Rahamimoff (1999) *Physiol. Rev.* **79**(3): 1019-1088
- Merrill, A. H., Jr., S. Nimkar, et al. (1989) *Biochemistry* **28**(8): 3138-3145
- Merrill, A. H., Jr. and V. L. Stevens (1989) *Biochim. Biophys. Acta* **1010**(2): 131-139
- Metzger, H. (1992) *Immunol. Rev.* **125**: 37-48
- Mittrucker, H. W. and B. Fleischer (1992) *Immunol.* **76**(4): 610-615
- Miura, K. and D. W. J. MacGlashan (1998) *Blood* **92**(4): 1206-1218

- Monick, M. M., A. B. Carter, G. Gudmundsson, L. J. Geist and G. W. Hunninghake (1998) *Am. J. Physiol.* **275**(2 Pt 1): L389-L397
- Monk, P. N., B. R. Bingham, T. B. Ahmad and B. A. Helm (1993) *Receptor* **3**(2): 77-86
- Montecucco, C. and G. Schiavo (1995) *Q. Rev. Biophys.* **28**(4): 423-472
- Mosior, M. and A. C. Newton (1995) *J. Biol. Chem.* **270**(43): 25526-25533
- Mosior, M. and A. C. Newton (1996) *Biochemistry* **35**(5): 1612-1623
- Muallem, S., K. Kwiatkowska, X. Xu and H. L. Yin (1995) *J. Cell Biol.* **128**(4): 589-598
- Muramatsu, M., K. Kaibuchi and K. Arai (1989) *Mol. Cell Biol.* **9**(2): 831-836
- Murguía, J. R., L. De Vries, L. Gomez-García, A. Schönthal and R. Perona (1995) *J. Cell Biochem.* **57**(4): 630-640
- Nabokina, S., G. Egea, J. Blasi and F. Mollinedo (1997) *Biochem. Biophys. Res. Commun.* **239**(2): 592-597
- Naccache, P. H., T. F. Molski, P. Borgeat, J. R. White and R. I. Sha'afi (1985) *J. Biol. Chem.* **260**(4): 2125-2131
- Nagaji, J. (1999) *Kurume Med. J.* **46**(3-4): 157-162
- Nakadate, T., A. Y. Jeng and P. M. Blumberg (1988) *Biochem. Pharmacol.* **37**(8): 1541-1545
- Nakanishi, S., Y. Matsuda, K. Iwahashi and H. Kase (1986) *J. Antibiot. (Tokyo)* **39**(8): 1066-1071
- Nakano, H., E. Kobayashi, I. Takahashi, T. Tamaoki, Y. Kuzuu and H. Iba (1987) *J. Antibiot. (Tokyo)* **40**(5): 706-708
- Narenjkar, J., S. J. Marsh and E. S. Assem (1999) *Cell Calcium* **26**(6): 261-269
- Nauseef, W. M., B. D. Volpp, S. McCormick, K. G. Leidal and R. A. Clark (1991) *J. Biol. Chem.* **266**(9): 5911-5917
- Nechushtan, H., M. Leitges, C. Cohen, G. Kay and E. Razin (2000) *Blood* **95**(5): 1752-1757
- Nelstuen, G. L. and M. D. Bazzi (1991) *J. Bioenerg. Biomembr.* **23**(1): 43-61
- Newton, A. C. (1995) *J. Biol. Chem.* **270**(48): 28495-28498
- Nichols, B. J., C. Ungermann, H. R. Pelham, W. T. Wickner and A. Haas (1997) *Nature* **387**(6629): 199-202

- Nishizuka, Y. (1988) *Nature* **334**(6184): 661-665
- Nishizuka, Y. (1992) *Science* **258**(5082): 607-614
- Nishizuka, Y. (1995) *Faseb J.* **9**(7): 484-496
- Nüsse, O., M. Lindau, O. Cromwell, A. B. Kay and B. D. Gomperts (1990) *J. Exp. Med.* **171**(3): 775-786
- Nüsse, O., L. Serrander, R. Foyouzi-Youssefi, A. Monod, D. P. Lew and K. H. Krause (1997) *J. Biol. Chem.* **272**(45): 28360-28367
- Nüsse, O., L. Serrander, D. P. Lew and K. H. Krause (1998) *EMBO J.* **17**(5): 1279-1288.
- Nye, S. H., S. P. Squinto, D. J. Glass, T. N. Stitt, P. Hantzopoulos, M. J. Macchi, N. S. Lindsay, N. Y. Ip and G. D. Yancopoulos (1992) *Mol. Biol. Cell* **3**(6): 677-686
- Oda, A., J. F. Daley, J. Kang, M. Smith, J. A. Ware and E. W. Salzman (1991) *Am. J. Physiol.* **260**(2 Pt 1): C242-248
- Ohkuma, S. and B. Poole (1978) *Proc. Natl. Acad. Sci. US A* **75**(7): 3327-3331
- Ohkuma, S. and B. Poole (1981) *J. Cell. Biol.* **90**(3): 656-664
- Oishi, K., R. L. Raynor, P. A. Charp and J. F. Kuo (1988) *J. Biol. Chem.* **263**(14): 6865-6871
- Oishi, K., B. Zheng and J. F. Kuo (1990) *J. Biol. Chem.* **265**(1): 70-75
- Omura, S., Y. Iwai, A. Hirano, A. Nakagawa, J. Awaya, H. Tsuchya, Y. Takahashi and R. Masuma (1977) *J. Antibiot. (Tokyo)* **30**(4): 275-282
- Orr, J. W. and A. C. Newton (1994) *J. Biol. Chem.* **269**(44): 27715-27718
- Oshiro, T., Y. Kakuta, S. Shimura, M. Nara and K. Shirato (2000) *Clin. Exp. Allergy* **30**(5): 699-705
- Ozawa, K., H. Kobayashi, E. Kawai, E. Suzaki, Y. Nonomura and T. Masujima (1996) *FEBS Lett.* **398**(1): 67-73
- Ozawa, K., Z. Szallasi, M. G. Kazanietz, P. M. Blumberg, H. Mischak, J. F. Mushinski and M. A. Beaven (1993) *J. Biol. Chem.* **268**(3): 1749-1756
- Packham, M. A., M. L. Rand, D. H. Ruben and R. L. Kinlough-Rathbone (1991) *Comp. Biochem. Physiol. A* **99**(4): 551-557
- Padfield, P. J., N. Panesar, P. Henderson and J. J. Baldassare (1996) *Biochem. J.* **314**(Pt 1): 123-128

- Page, L. J., A. J. Darmon, R. Uellner and G. M. Griffiths (1998) *Biochim. Biophys. Acta* **1401**(2): 146-156
- Parker, P. J., L. Bosca, L. Dekker, N. T. Goode, N. Hajibagheri and G. Hansra (1995) *Biochem. Soc. Trans.* **23**: 153-155
- Parton, R. G., C. G. Dotti, R. Bacallao, I. Kurtz, K. Simons and K. Prydz (1991) *J. Cell Biol.* **113**(2): 261-274
- Pears, C. J., G. Kour, C. House, B. E. Kemp and P. J. Parker (1990) *Eur. J. Biochem.* **194**(1): 89-94
- Pecht, I. and A. Corcia (1987) *Biophys. Chem.* **26**(2-3): 291-301
- Perin, M. S., V. A. Fried, G. A. Mignery, R. Jahn and T. C. Sudhof (1990) *Nature* **345**(6272): 260-263
- Perisic, O., S. Fong, D. E. Lynch, M. Bycroft and R. L. Williams (1998) *J. Biol. Chem.* **273**(3): 1596-1604
- Pestel, J., M. Joseph, F. Santoro and A. Capron (1979) *Ann. Immunol. (Paris)* **130C**(4): 507-516
- Pinxteren, J. A., A. J. O'Sullivan, P. E. Tatham and B. D. Gomperts (1998) *EMBO J.* **17**(21): 6210-6218
- Pitzurra, L., E. Blasi, M. Puliti and F. Bistoni (1993) *Infect. Immun.* **61**(9): 3605-3610
- Pitzurra, L., P. Marconi, F. Bistoni and E. Blasi (1989) *Infect. Immun.* **57**(8): 2452-2456
- Platt, N., R. P. da Silva and S. Gordon (1998) *Trends Cell Biol.* **8**(9): 365-372
- Poll, C. and J. Westwick (1986) *Biochim. Biophys. Acta* **886**(3): 434-440
- Pontremoli, S., E. Melloni, M. Michetti, O. Sacco, F. Salamino, B. Sparatore and B. L. Horecker (1986) *J. Biol. Chem.* **261**(18): 8309-8313
- Poole, B. and S. Ohkuma (1981) *J. Cell. Biol.* **90**(3): 665-669
- Proks, P., L. Eliasson, C. Ammala, P. Rorsman and F. M. Ashcroft (1996) *J. Physiol.* **496**(Pt 1): 255-264
- Quest, A. F. (1996) *Enzyme Protein* **49**(5-6): 231-261
- Quick, J., J. A. Ware and P. E. Driedger (1992) *Biochem. Biophys. Res. Commun.* **187**(2): 657-663
- Ramachandra, L., R. Song and C. V. Harding (1999) *J. Immunol.* **162**(6): 3263-3272

- Ramakers, G. M., D. D. Gerendasy and P. N. de Graan (1999) *J. Biol. Chem.* **274**(4): 1873-1874
- Rameh, L. E., and L. C. Cantley (1999) *J. Biol. Chem.* **274**(13):8347-8350
- Riches, D. W. and D. R. Stanworth (1980) *Biochem. J.* **188**(3): 933-936
- Riches, D. W. and D. R. Stanworth (1982) *Biochem. J.* **202**(3): 639-645
- Riches, D. W., J. L. Watkins and D. R. Stanworth (1983) *Biochem. J.* **212**(3): 869-874
- Rink, T. J., A. Sanchez and T. J. Hallam (1983) *Nature* **305**(5932): 317-319
- Rodriguez, A., P. Webster, J. Ortego and N. W. Andrews (1997) *J. Cell. Biol.* **137**(1): 93-104
- Roitt, I. (1991) *Essential Immunology*, Blackwell Scientific Publications.
- Ron, D., J. Luo and D. Mochly-Rosen (1995) *J. Biol. Chem.* **270**(41): 24180-24187
- Ron, D. and D. Mochly-Rosen (1995) *Proc. Natl. Acad. Sci. U S A* **92**(2): 492-496
- Rotenberg, S. A., Huang, M. H., Zhu, J., Su, L., and H. Riedel (1995) *Mol. Carcinog.* **12**(1): 42-49
- Rothman, J. E. and L. Orci (1992) *Nature* **355**(6359): 409-415
- Rotondo, S., V. Evangelista, S. Manarini, G. de Gaetano and C. Cerletti (1997) *Thromb. Haemost.* **78**(2): 919-925
- Ruegg, U. T. and G. M. Burgess (1989) *Trends Pharmacol. Sci.* **10**(6): 218-220
- Rutherford, M. S., A. Witsell and L. B. Schook (1993) *J. Leukoc. Biol.* **53**(5): 602-618
- Sagi-Eisenberg, R. and I. Pecht (1984) *Immunol. Lett.* **8**(5): 237-241
- Sakai, N., K. Sasaki, N. Ikegaki, Y. Shirai, Y. Ono and N. Saito (1997) *J. Cell. Biol.* **139**(6): 1465-1476
- Sanchez-Pinera, P., V. Micol, S. Corbalan-Garcia and J. C. Gomez-Fernandez (1999) *Biochem. J.* **337**(Pt 3): 387-395
- Satin, L. S. (2000) *Endocrine* **13**(3): 251-262
- Scepek, S., J. R. Coorssen and M. Lindau (1998) *EMBO J.* **17**(15): 4340-4345

- Schaap, D. and P. J. Parker (1990) *J. Biol. Chem.* **265**(13): 7301-7307
- Schneider, D. L. (1981) *J. Biol. Chem.* **256**: 3858-3864
- Schnyder, J. and M. Baggiolini (1978) *J. Exp. Med.* **148**(2): 435-450
- Schorlemmer, H. U. and A. C. Allison (1977) *Monogr. Allergy* **12**: 115-119
- Schorlemmer, H. U., P. Davies and A. C. Allison (1976) *Nature* **261**(5555): 48-49
- Schorlemmer, H. U., P. Davies, W. Hylton, M. Gugig and A. C. Allison (1977) *Br. J. Exp. Pathol.* **58**(3): 315-326
- Schrezenmeier, H., G. Ahnert-Hilger and B. Fleischer (1988) *J. Immunol.* **141**(11): 3785-3790
- Seetoo, K. F., J. E. Schonhorn, A. T. Gewirtz, M. J. Zhou, M. E. McMenamin, L. Delva and E. R. Simons (1997) *J. Leukoc. Biol.* **62**(3): 329-340
- Segal, M. (1989) *Neurosci. Lett.* **101**(2): 169-174
- Seljelid, R. and T. Eskeland (1993) *Eur. J. Haematol.* **51**: 267-275
- Sengeløv, H., L. Kjeldsen and N. Borregaard (1993) *J. Immun.* **150**: 1535-1543
- Sergeant, S. and L. C. McPhail (1997) *J. Immunol.* **159**: 2877-2885
- Sha'afi, R. I., T. F. Molski, C. K. Huang and P. H. Naccache (1986) *Biochem. Biophys. Res. Comm.* **137**(1): 50-60
- Shaw, J. O., I. Brodersen and R. M. Lyons (1982) *Agents Actions* **12**(3): 328-332
- Shefler, I., Z. Taube, O. Medalia and R. Sagi-Eisenberg (1998) *Eur. J. Immunol.* **28**(11): 3468-3478
- Shepherd, V. L., M. G. Konish and P. Stahl (1985) *J. Biol. Chem.* **260**(1): 160-164
- Shimazaki, Y., T. Nishiki, A. Omori, M. Sekiguchi, Y. Kamata, S. Kozaki and M. Takahashi (1996) *J. Biol. Chem.* **271**(24): 14548-14553
- Siraganian, R. P. (1992) Mast Cells and Basophils. *Inflammation. Basic Principles and Clinical Correlates.* J. I. Gallin, I. M. Goldstein and R. Snyderman. New York, Raven Press: 513-542
- Si-Tahar, M., P. Renesto, H. Falet, F. Rendu and M. Chignard (1996) *Biochem. J.* **313** (Pt 2): 401-408
- Sloan, D. C. and R. J. Haslam (1997) *Biochem. J.* **328**(Pt 1): 13-21

Smallwood, J. I. and S. E. Malawista (1992) *J. Leukoc. Biol.* **51**(1): 84-92

Smith, R. J., J. M. Justen and L. M. Sam (1988a) *Biochem. Biophys. Res. Comm.* **152**(3): 1497-1503

Smith, R. J., J. M. Justen and L. M. Sam (1988b) *Inflammation* **12**(6): 597-611

Smith, R. J., W. Wierenga and S. S. Iden (1980) *Inflammation* **4**(1): 73-88

Smolen, J. E. and R. R. Sandborg (1990) *Biochim. Biophys. Acta* **1052**(1): 133-142

Smolen, J. E., S. J. Stoehr and D. Bartone (1989) *Cell. Signal.* **1**(5): 471-481

Smolen, J. E., Stoehr, S. J., Traynor, A. E. and L. A. Sklar (1987) *J. Leukoc. Biol.* **41**: 8-13

Sogaard, M., K. Tani, R. R. Ye, S. Geromanos, P. Tempst, T. Kirchhausen, J. E. Rothman and T. Sollner (1994) *Cell* **78**(6): 937-948

Sohal, P. S. and R. B. Cornell (1990) *J. Biol. Chem.* **265**(20): 11746-11750

Stewart, B. H. and D. W. Hoskin (1997) *Biochim. Biophys. Acta* **1356**(3): 333-342

Stevens, C. F. and J. M. Sullivan (1998) *Neuron* **21**(4): 885-893

Storrie, B. (1988) *Int. Rev. Cytol.* **111**: 53-105

Stump, R. F., J. M. Oliver, E. J. J. Cragoe and G. G. Deanin (1987) *J. Immunol.* **139**(3): 881-886

Sudhof, T. C. (2000) *Neuron* **28**(2): 317-320

Sudhof, T. C. and J. Rizo (1996) *Neuron* **17**(3): 379-388

Sundler, R. (1997) *Acta Physiol. Scand.* **161**: 553-556

Swallow, C. J., S. Grinstein, R. A. Sudsbury and O. D. Rotstein (1990) *Surgery* **108**(2): 363-369

Swanson, J. A., A. Locke, P. Ansel and P. J. Hollenbeck (1992) *J. Cell Sci.* **103**(Pt 1): 201-209

Söllner, T., M. Bennet, S. W. Witeheart, R. H. Scheller and J. E. Rothman (1993) *Cell* **75**: 409-418

Takano, Y., K. Imai, A. Tanaka, K. Fujimori, M. Yamada and K. Yamamoto (1984) *Cell Struct. Funct.* **9**(3): 265-277

Takayama, H. and M. V. Sitkovsky (1987) *J. Exp. Med.* **166**(3): 725-743

- Tamaoki, T., H. Nomoto, I. Takahashi, Y. Kato, M. Morimoto and F. Tomita (1986) *Biochem. Biophys. Res. Commun.* **135**(2): 397-402
- Tapper, H. and R. Sundler (1990) *Biochem. J.* **272**(2): 407-414
- Tapper, H. and R. Sundler (1992a) *Biochem. J.* **281** (Pt 1): 239-244
- Tapper, H. and R. Sundler (1992b) *Biochem. J.* **281** (Pt 1): 245-250
- Tapper, H. and R. Sundler (1995a) *J. Cell Physiol.* **163**(1): 137-144
- Tapper, H. and R. Sundler (1995b) *Biochem. J.* **306**(Pt 3): 829-835
- Tapper, H. and R. Sundler (1995c) *J. Leukoc. Biol.* **58**: 485-494
- Tapper, H. and S. Grinstein (1997) *J. Immunol.* **159**: 409-418
- Tauber, A. I. (1987) *Blood* **69**(3): 711-720
- Taylor, S. S. and E. Radzio-Andzelm (1994) *Structure* **2**(5): 345-355
- Thorner, J. W. (2001) *Nature Cell Biol.* **3**: E196-E198
- Ting, A. T., R. A. Schoon, R. T. Abraham and P. J. Leibson (1992) *J. Biol. Chem.* **267**(33): 23957-23962
- Toker, A. (1998) *Front. Biosci.* **3**: 1134-1147
- Toker, A. (2000) *Mol. Pharmacol.* **57**: 652-658
- Toullec, D., P. Pianetti, et al. (1991) *J. Biol. Chem.* **266**(24): 15771-15781.
- Turner, K. M., R. D. Burgoyne and A. Morgan (1999) *Trends Neurosci* **22**(10): 459-464
- Umehara, H., Huang, J-Y., Kono, T., Tabassam, F. H., Okazaki, T., Bloom, E. T., and N. Domae (1997) *J. Immunol.* **159**: 1200-1207
- Vale, R. D. and R. J. Fletterick (1997) *Annu Rev. Cell Dev. Biol.* **13**: 745-777
- Walzog, B., R. Seifert, A. Zakrzewicz, P. Gaehtgens and K. Ley (1994) *J. Leukoc. Biol.* **56**(5): 625-635
- Van Furth, R., M. C. Diesselhoff-den Dulk and H. Mattie (1973) *J. Exp. Med.* **138**(6): 1314-1330
- Van Oost, B. A., J. B. Smith, H. Holmsen and G. D. Vladutiu (1985) *Proc. Natl. Acad. Sci. U S A* **82**(8): 2374-2378
- Vanhaesebroeck, B., and M. D. Waterfield (1999) *Exp. Cell Res.* **253**: 239-254
- Warner, J. A. and D. W. J. MacGlashan (1990) *J. Immunology* **145**(6): 1897-1905
- Webb, B. L. J., Hirst, S. J. and M. A. Giembycz (2000) *Br. J. Pharm.* **130**: 1433-1452

Weber, T., B. V. Zemelman, J. A. McNew, B. Westermann, M. Gmachl, F. Parlati, T. H. Sollner and J. E. Rothman (1998) *Cell* **92**(6): 759-772

Weksler, B. B. (1992) Platelets. *Inflammation. Basic Principles and Clinical Correlates*. J. I. Gallin, I. M. Goldstein and R. Snyderman. New York, Raven Press: 727-746

Wetsel, W. C., W. A. Khan, I. Merchenthaler, H. Rivera, A. E. Halpern, H. M. Phung, A. Negro-Vilar and Y. A. Hannun (1992) *J. Cell. Biol.* **117**(1): 121-133

Wheeler-Jones, C. P., T. Saermark, V. V. Kakkar and K. S. Authi (1992) *Biochem. J.* **281** (Pt 2): 465-472

White, J. G. (1994) Anatomy and structural organization of the platelet. *Hemostasis and Thrombosis: Basic Principles and Clinical Practice*. Colman, R. W., Hirsch, J., Marder, V. J. and E. W. Salzman 3rd ed. Philadelphia, JB Lippincott: 397-413

White, J. R., C. K. Huang, J. M. J. Hill, P. H. Naccache, E. L. Becker and R. I. Sha'afi (1984) *J. Biol. Chem.* **259**(13): 8605-8611

Wilkinson, S. E., P. J. Parker and J. S. Nixon (1993) *Biochem. J.* **294**(Pt 2): 335-337

Williams, B. A., J. Blay and D. W. Hoskin (1997) *Exp. Cell. Res.* **233**(1): 187-197

Wisse, E. and D. L. Knook (1979) *Prog. Liver Dis.* **6**: 153-171

Vitale, M. L., E. P. Seward and J. M. Trifaro (1995) *Neuron* **14**(2): 353-363

Wolf, M. and M. Baggiolini (1988) *Biochem. Biophys. Res. Commun.* **154**(3): 1273-1279

Wymann, M. P., Sozzani, S., Altruda, F., Mantovani, A., and E. Hirsch (2000) *Trends Immunol. Today* **21**(6): 260-264

Yamada, K., C. L. Jelsema and M. A. Beaven (1992) *J. Immunol.* **149**(3): 1031-1037

Yanagihara, N., E. Tachikawa, F. Izumi, S. Yasugawa, H. Yamamoto and E. Miyamoto (1991) *J. Neurochem.* **56**(1): 294-298

Zaman, W., T. Mitsuyama, M. Hatakenaka, D. Kang, S. Minakami and K. Takeshige (1994) *J. Biochem.* **115**(2): 238-244

Zeidman, R., B. Lofgren, S. Pahlman and C. Larsson (1999) *J. Cell. Biol.* **145**(4): 713-726

- Zheleznyak, A. and E. J. Brown (1992) *J. Biol. Chem.* **267**(17): 12042-12048
- Zheng, L., T. P. L. Zomerdijk, C. Aarnoudse, R. van Furth and P. H. Nibbering (1995) *J. Immunol.* **155**: 776-784
- Zimmermann, H. (1990) *FEBS Lett.* **268**(2): 394-399



Dexamethasone lowers cytosolic pH in macrophages by altering alkalinizing pH-regulatory mechanisms

Claes Nauc ler, Roger Sundler, and Hans Tapper

Department of Cell and Molecular Biology, Section for Molecular Pathogenesis, Lund University, Sweden

Abstract: The effect of dexamethasone on cytosolic pH (pH_c) in resident mouse peritoneal macrophages was investigated using the fluorescent probe 2',7'-bis(carboxyethyl)-5(6)-carboxyfluorescein tetra-acetoxymethyl ester (BCECF-AM). Dexamethasone was found to significantly lower pH_c and this reduction of pH_c evolved gradually with time, was near maximal at 10 nM dexamethasone, and could be prevented by the glucocorticoid receptor antagonist RU-38486. The lower pH_c of dexamethasone-treated cells was neither due to a reduction of cellular buffer capacity nor to an altered regulation of pH_c by Na^+/H^+ -exchange or by acidifying Na^+ -independent Cl^-/HCO_3^- exchange, as assessed by studies of pH recovery after acute acid and alkali loads, respectively. Instead, an impaired pH_c recovery by both the H^+ -ATPase and the alkalinizing Na^+ -dependent Cl^-/HCO_3^- exchange was observed. This impairment was most likely not caused by an altered expression or localization of the 39-kDa subunit of the proton pump. Dexamethasone treatment caused a reduction of pH_c also in a HCO_3^- -containing solution, suggesting that acid extrusion by both the H^+ -ATPase and Na^+ -dependent Cl^-/HCO_3^- exchange is important for maintenance and regulation of macrophage resting pH_c . The lowering of macrophage pH_c might be one mechanism whereby glucocorticoids exert their anti-inflammatory effects. *J. Leukoc. Biol.* 67: 876–884; 2000.

Key Words: glucocorticoid · cytosolic pH · H^+ -ATPase · Cl^-/HCO_3^- -exchange

INTRODUCTION

Macrophages are present in virtually all types of tissue and have important immunological and pathological functions. As effector cells they are able to directly kill microorganisms and tumor cells and they also partake in tissue remodeling processes. Furthermore, by their ability to secrete various substances they affect other cell types, and macrophage-derived products have been implicated in pathological processes such as atherosclerosis and rheumatoid arthritis [1]. At an inflammatory site, macrophages are exposed to a variable environment (pH, nutritional status, oxygenation) in which they must defend and maintain a closely regulated cytosolic pH (pH_c) [2]. This is

in part accomplished by a tight regulation of plasma membrane-localized alkalinizing and acidifying mechanisms. Macrophages utilize bicarbonate for pH regulation by an alkalinizing Na^+ -dependent Cl^-/HCO_3^- -exchanger and an acidifying Na^+ -independent Cl^-/HCO_3^- -exchanger [3]. These mechanisms, together with a H^+ -ATPase [4], operate in the physiological pH range and determine baseline pH_c in resting macrophages. These cells also express a Na^+/H^+ -exchanger, but this mechanism operates only after a larger acidification of the cytosol in quiescent macrophages [3, 5].

A permissive pH_c is required for some highly pH-sensitive macrophage functions like phagocytosis [6], lysosomal secretion [7], superoxide production [6, 8], and cytokine release [6]. Cytosolic pH regulation is crucial for these important immune functions and also for the function of several cytosolic enzymes with pH optima in the physiological range [9]. Effects of pH_c on transactivation of transcription factors [10, 11] and apoptosis [12] have also been suggested.

If a therapeutic agent interferes with H^+ -ATPase-mediated acid extrusion, this would affect pH_c in cell types that rely on this transporter for maintenance of steady-state pH_c . A selective lowering of macrophage pH_c at an inflammatory site could allow therapeutic intervention by selectively targeting a cell type important for the regulation of the inflammatory process. In this study, we show that dexamethasone lowers pH_c in mouse macrophages by inhibition of both H^+ -ATPase and Na^+ -dependent Cl^-/HCO_3^- exchange, the two mechanisms that normally determine the resting pH_c of the macrophage [3].

MATERIALS AND METHODS

Materials

Bafilomycin A_1 was kindly provided by Prof. Altendorf, Osnabr ck, Germany. Bafilomycin A_1 was also purchased from Biomol (Plymouth Meeting, PA). 4,4'-Diisothiocyanatostilbene 2,2'-disulfonic acid (DIDS), choline chloride (99% purity), choline bicarbonate (80% aqueous solution), fluorescein isothiocyanate-dextran (mol. wt. 40,500, FD), amiloride, dexamethasone, and nigericin were purchased from Sigma (St. Louis, MO). 2',7'-Bis(carboxyethyl)-5(6)-carboxyfluorescein tetra-acetoxymethyl ester (BCECF-AM) was purchased from Molecular Probes (Eugene, OR). RU-38486 was kindly provided by Roussel Uclaf (Paris, France).

Correspondence: Claes Nauc ler, Department of Cell and Molecular Biology, Section for Molecular Pathogenesis, Lund University, P.O. Box 94, S-221 00 Lund, Sweden. E-mail: claes.naucler@medkem.lu.se

Received September 7, 1999; revised December 20, 1999; accepted December 22, 1999.

Solutions

Na medium contained the following (in mM): NaCl, 127; KH_2PO_4 , 1.2; KCl, 5.4; MgSO_4 , 0.8; CaCl_2 , 1.8; glucose, 5.6; 4-(2-hydroxyethyl)-1-piperazine-ethanesulfonic acid (HEPES), 10; and pH was adjusted with NaOH.

In Ch medium, NaCl was exchanged for choline chloride and pH was adjusted with KOH.

K medium contained the following (in mM): NaCl, 5.4; KCl, 127; MgSO_4 , 0.8; CaCl_2 , 1.8; glucose, 5.6; HEPES 10; NaH_2PO_4 , 1.2; and pH was adjusted with KOH.

Na/ HCO_3 medium contained the following (in mM): NaCl, 108.5; KH_2PO_4 , 1.2; KCl, 5.4; MgSO_4 , 0.8; CaCl_2 , 1.8; glucose, 5.6; NaHCO_3 , 18.5; pH was adjusted by varying the CO_2 partial pressure.

Ch/ HCO_3 medium contained the following (in mM): choline chloride, 108.5; KH_2PO_4 , 1.2; KCl, 5.4; MgSO_4 , 0.8; CaCl_2 , 1.8; glucose, 5.6; choline HCO_3 , 18.5; pH was adjusted by varying the CO_2 partial pressure.

Cell harvest and culture

Four milliliters of Medium 199 containing 1% heat-inactivated fetal calf serum was used for peritoneal lavage of female outbred NMRI mice (Bomnice, Copenhagen, Denmark). Macrophages pooled from 6–12 mice were used for each experiment. The peritoneal cells thus obtained were adhered onto 12-mm-diameter coverslips for 2 h at 37°C in a humidified atmosphere containing 5% CO_2 . Thereafter, nonadherent cells were washed away with phosphate-buffered saline. Medium 199 (2 mL) containing 10% serum with or without dexamethasone was then added to each well and the cells were further cultured for 20 h. When cells were cultured for measurement of lysosomal pH the medium also contained FD (0.5 mg/mL).

Measurement of cytosolic and lysosomal pH

All measurements were performed on a SLM 8000 spectrofluorometer equipped with magnetic stirring and a thermostated perfusion system for control of media temperature and flow rate. Coverslips were placed in Na medium without serum at 37°C for 30 min before experiments. For measurement of pH_c , cells were loaded with BCECF by incubation with its acetoxymethyl ester (0.2 μM) for 10 min in atmospheric CO_2 partial pressure. When measuring pH recovery, cells were acid-loaded by adding NH_4Cl for 15 min followed by its removal before measurements of pH recovery. Alkali loading was performed by a similar preincubation using Na-acetate. Before experiments, extracellular BCECF-AM was removed by washing twice with the experimental medium. When ammonium or acetate was removed, this resulted in a rapid acidification or alkalinization of the cytosol. The recording of the experimental traces was then initiated within 1 min. The coverslip was placed in a specially designed holder in a standard fluorescence cuvette holding 2 mL through which the experimental medium was perfused at a flow rate of 1 mL/min. When inspected in a standard fluorescence microscope, macrophages showed a cytosolic distribution of BCECF both in control cells and in cells treated with dexamethasone. In experiments where Na/ HCO_3 medium was used, a gas mixture of 75% N_2 , 20% O_2 , and 5% CO_2 was applied in order to maintain pH_e at 7.2. The pH of this medium was spectrofluorometrically assured by the addition of BCECF (10 nM). For experiments in bicarbonate-containing media, loading of the cells with BCECF was performed in an atmosphere of 5% CO_2 . For measurements of pH_c , the wavelengths for excitation were 506/456 nm and for emission 527 nm. The fluorescence ratio obtained was calibrated by clamping the pH_c to the pH_e using K medium and nigericin (10 μM). The fluorescence ratio was determined at various pH_e and showed linearity between pH 6.25 and 7.5. For measurement of lysosomal pH, overnight culture of the cells was in the presence of 0.5 mg/mL FD. This pH-sensitive fluorescent probe is pinocytosed and accumulates in the lysosomal compartment. The same experimental procedure as for measuring pH_c was used, but with wavelengths for excitation set at 497/456 nm and for emission at 518 nm.

Measurement of buffer capacity

Cellular buffer capacity was estimated using a method previously described [13]. Briefly, pH_c was measured in Ch medium containing amiloride (600 μM), bafilomycin A_1 (100 nM), and ammonium chloride at $\text{pH}_e = 7.2$. The concentration of ammonium was reduced stepwise (30, 20, 10, and 0 mM) by rapid perfusion (10 mL/min) and for each change in concentration of

ammonium chloride, the $\Delta[\text{H}^+]$ was calculated from the Henderson-Hasselbach equation and the obtained steady-state pH_c . Values of buffer capacity ($\beta = \Delta[\text{H}^+]/\Delta\text{pH}_c$) were determined at three different pH_c in each experiment.

Electrophoresis and Western blot analysis

Macrophages were cultured in 12-well plates with 1.5 million cells per well and treated with or without dexamethasone for 20 h. Cells were washed twice in phosphate-buffered saline (PBS) buffer and then lysed in sample buffer, boiled for 10 min, and subjected to sodium dodecyl sulfate (SDS)-polyacrylamide gel electrophoresis according to the method of Laemmli [14], using 1.5-mm slab gels. Separation and stacking gels contained 10 and 3% polyacrylamide, respectively. Samples equaling 0.6 million cells were loaded in each lane. Proteins were separated at 12 mA for 20 h and then electrophoretically transferred to PVDF membranes (Millipore, Bedford, MA) at 100 V for 2 h. The membranes were blocked by incubation in 3% gelatin (Bio-Rad, Hercules, CA) in TBS (10 mM Tris, 150 mM NaCl, pH 7.5) for 2 h and probed with an antibody to the H^+ -ATPase 39-kDa C-subunit, which is part of the V_0 complex (kindly provided by Prof. Sergio Grinstein, Toronto, Canada) at a 1:1000 dilution for 20 h. Membranes were washed and incubated with a goat anti-rabbit horseradish peroxidase secondary antibody (Santa Cruz Biotechnology, Santa Cruz, CA) at a 1:3000 dilution for 1 h. Bands were detected by chemiluminescence using Super Signal (Pierce, Rockford, IL).

Immunofluorescence microscopy

Macrophages were adhered on 19-mm coverslips and cultured with or without dexamethasone for 20 h. Cells were then put on ice, washed twice in cold PBS, and fixed with 1% paraformaldehyde (Becton Dickinson, Franklin Lakes, NJ) for 20 min on ice and for an additional 100 min at room temperature. After two washes in PBS, the cells were permeabilized in cytoskeletal buffer containing 100 mM KOH, 2 mM MgCl_2 , 5 mM EGTA, 0.02% Triton X-100, and 100 mM PIPES (pH 6.8) for 15 min on ice and thereafter blocked for 3 h in PBS containing 5% donkey serum (Sigma, St. Louis, MO) at room temperature. Cells were labeled with the antibody against the H^+ -ATPase C-subunit at a dilution of 1:200 in PBS containing 1% BSA at 4°C overnight, washed twice, and probed with a goat anti-rabbit Cy3 secondary antibody (Jackson Immunoresearch Laboratories, West Grove, PA) at 1:800 dilution for 90 min at room temperature. Coverslips were then washed three times and mounted with anti-fade mounting medium (DAKO, Carpinteria, CA) for microscopic observation. Images were recorded on a Nikon Eclipse TE300 inverted fluorescence microscope equipped with a Hamamatsu C4742-95 cooled camera, using a Plan Apochromat $\times 100$ objective and a high N.A. oil condenser.

RESULTS

A lower pH_c was observed after dexamethasone treatment

Dexamethasone treatment (10 nM for 20 h) significantly lowered resting pH_c of mouse peritoneal macrophages (Student's *t* test, $P < 0.005$, Fig. 1A). At $\text{pH}_e = 7.2$, control cells maintained a pH_c of 7.24 ± 0.009 (SEM, $n = 53$) while the pH_c in dexamethasone-treated cells was lowered by 0.087 ± 0.008 pH units (SEM, $n = 38$). This effect of dexamethasone on pH_c was dose-dependent and near maximal at a concentration of 10 nM (Fig. 1A). Of note is that a significant dexamethasone-induced (10 nM for 20h) lowering of pH_c was found also when measured in HCO_3^- -containing media ($P < 0.01$, $\Delta\text{pH} = 0.140 \pm 0.028$, SEM, $n = 6$). Dexamethasone had no immediate effect on pH_c , and the decrease in pH_c appeared gradually with dexamethasone treatment ($P < 0.05$ at 4 h, Fig. 1B). Furthermore, the effect appeared to be mediated through the glucocorticoid receptor because the reduction of pH_c was abrogated when the antagonist RU-38486 (1 μM) was added to the cell

cultures before treatment with dexamethasone (Fig. 1A). Observe that the difference in pH_c between dexamethasone-treated and control cells was even larger in a more acidic medium ($P < 0.05$ at $pH_e = 6.0$, Fig. 1C) and somewhat smaller in a more alkaline medium. When pH_c was clamped in K medium containing nigericin (10 μ M), the recorded pH level was identical in dexamethasone-treated and control cells (results not shown). An inhibition of proton-pumping into acidic compartments could manifest as a lower cytosolic pH, and

therefore we assessed the effect of dexamethasone on the lysosomal pH of macrophages pre-loaded with FD. Lysosomal pH was similar in control cells and dexamethasone-treated cells (results not shown).

Neither cellular buffer capacity nor metabolic acid production was altered by dexamethasone treatment

Dexamethasone (10 nM for 20 h) did not significantly change the intrinsic buffer capacity recorded in the absence of HCO_3^- , and the dependence of cellular buffer capacity on pH_c was similar in dexamethasone-treated and control cells (Fig. 2, A and B). Furthermore, we examined the spontaneous acidification of cells under conditions where all alkalinizing pH-regulatory mechanisms should be inhibited (Ch medium, $pH_e = 7.2$, supplemented with an inhibitor of Na^+/H^+ -exchange (amiloride, 600 μ M) and a specific inhibitor of vacuolar type H^+ -ATPase (bafilomycin A_1 , 15 nM). The acidification rate did not differ between control and dexamethasone-treated cells with or without prior acid load (Fig. 2C). Nor was there any difference in acidification rate after a preincubation in glucose-free medium, a treatment that was previously shown to inhibit lactate-mediated proton extrusion to the extracellular medium [4]. Hence, the lowered pH_c observed in dexamethasone-treated cells was neither due to an altered buffer capacity of the cells nor to an increased cellular production of acidic metabolites.

Effects of dexamethasone treatment on HCO_3^- -dependent mechanisms

Because the decrease in pH_c caused by dexamethasone treatment was observed also in a HCO_3^- -buffered medium (Fig. 1A), we studied the effect of dexamethasone on the bicarbonate-utilizing pH-regulatory mechanisms in isolation. The activity of the acidifying Na^+ -independent Cl^-/HCO_3^- exchanger was measured as the rate of recovery from an alkali load induced by acetate pretreatment in a Ch/ HCO_3^- medium containing bafilomycin A_1 and amiloride. The rapid phase of the recovery of pH_c was identical in dexamethasone-treated and control cells (Fig. 3, A and B). In a Na/ HCO_3^- medium containing bafilomycin A_1 and amiloride, control cells recovered their pH_c after an acid load to a higher level than dexamethasone-treated cells (Fig. 4, A and B). The difference seen in pH_c between control and

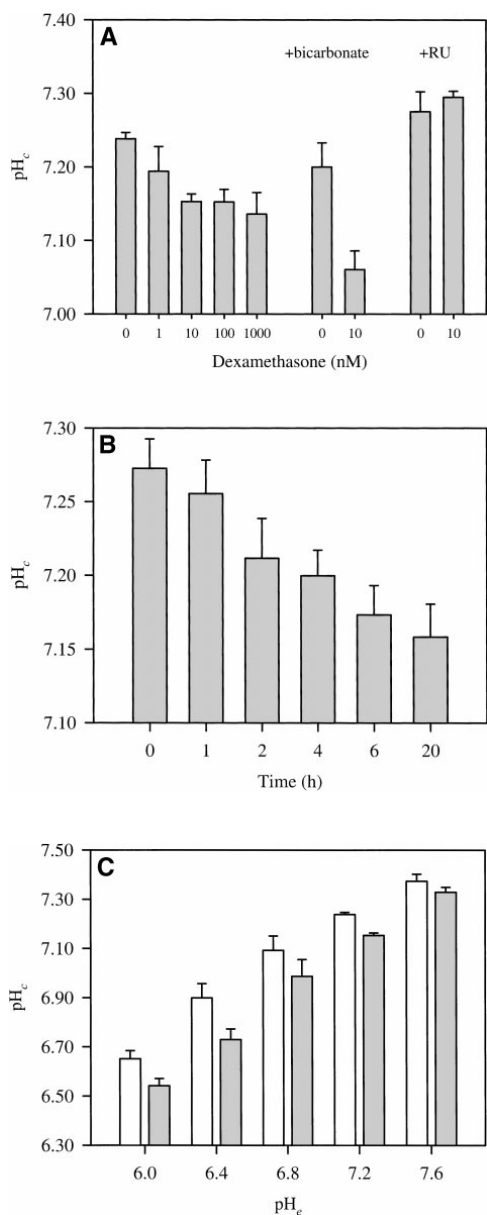

Fig. 1. Reduction of cytosolic pH by dexamethasone (A). Measurements of pH_c in Na medium, $pH_e = 7.2$. Data are presented as means with standard errors. Bars show pH_c in control cells and in cells treated with 1, 10, 100, and 1000 nM dexamethasone for 20 h (SEM, $n = 53, 6, 42, 10, 7$). Also shown is pH_c measured in Na/ HCO_3^- medium, $pH_e = 7.2$ in control cells and cells treated with 10 nM dexamethasone for 20 h (SEM, $n = 6, 6$). The right bars show pH_c measured in Na medium, $pH_e = 7.2$, in cells treated with RU-38486 (1 μ M for 20 h), and cells treated with both RU-38486 and dexamethasone (10 nM for 20 h, SEM, $n = 3, 3$). (B) pH_c in control cells and cells treated with dexamethasone, 10 nM, for 0, 1, 2, 4, 6, and 20 h (SEM, $n = 10, 6, 5, 7, 7, 11$). Cells were first cultured for 20 h without dexamethasone and then treated with dexamethasone (10 nM). Control cells were cultured in parallel without the addition of dexamethasone. Measurements were performed in Na medium, $pH_e = 7.2$. (C) Measurements of pH_c in Na medium at various pH_e . Control cells, open bars; cells treated with dexamethasone, 10 nM for 20 h, filled bars (SEM, $n = 4, 4, 3, 3, 4, 4, 53, 42, 7, 7$).

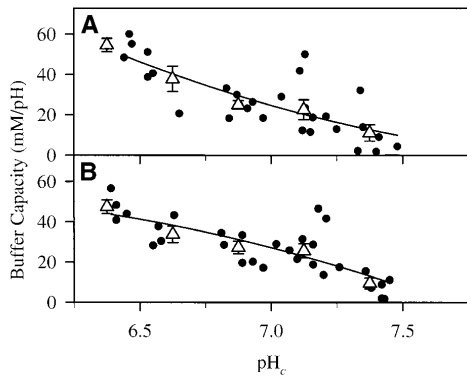

Fig. 2. Effect of dexamethasone treatment on the intrinsic buffer capacity and production of acidic metabolites. The intrinsic buffer capacity was calculated as described in Materials and Methods. (A) Control cells; (B) dexamethasone-treated cells (10 nM, 20 h). Data were obtained from five separate experiments (filled circles). Data were grouped in 0.5 pH-unit intervals and are presented as means with standard errors (open triangles). Solid lines are regressions of the second order. (C) Measurements of pH_c were performed in Ch medium, $pH_c = 7.2$, containing amiloride (600 μ M) and bafilomycin A_1 (15 nM). In the two middle traces, cells were incubated in Na medium devoid of glucose for 30 min before measurement of pH_c performed in Ch medium without glucose, $pH_c = 7.2$, containing amiloride (600 μ M) and bafilomycin A_1 (15 nM). For the two lower traces, cells were acid-loaded with NH_4Cl (20 mM) before registration of pH_c . Control cells are denoted by solid traces; dexamethasone-treated cells (10 nM, 20 h) are denoted by dotted traces. Traces in panel C are representative of at least three separate experiments.

dexamethasone-treated cells after 20 min recovery is maintained and resembles the approximate resting pH values under these conditions (Fig. 1A). Although the conditions of this experiment would allow the activity of both Na^+ -dependent and Na^+ -independent Cl^-/HCO_3^- exchangers, the presence of Na^+ is required in order to make a dexamethasone-induced lowering of pH_c in a bicarbonate-containing medium evident (Fig. 4A, see Fig. 3A).

Effects of dexamethasone treatment on Na^+/H^+ exchange

The activity of Na^+/H^+ -exchange was measured in Na medium containing bafilomycin A_1 and an inhibitor of bicarbonate-

dependent pH-regulatory mechanisms (DIDS, 600 μ M). Under these conditions, there was no difference in recovery rate after an acid load between control and dexamethasone-treated cells, and they recovered to the same level of pH_c (Fig. 5, A and B). pH_c recovery under these conditions was mediated by Na^+/H^+ -exchange because it was inhibited in the presence of amiloride (Fig. 5A, lower solid trace).

Effects of dexamethasone treatment on H^+ -ATPase-mediated pH regulation

In a Ch medium containing amiloride, H^+ -ATPase-mediated proton extrusion should be the only pH-regulatory mechanism operative after an acid load [4, 5]. When observing recovery from an acid load in such a medium, a lower recovery rate was always observed in cells treated with dexamethasone. These

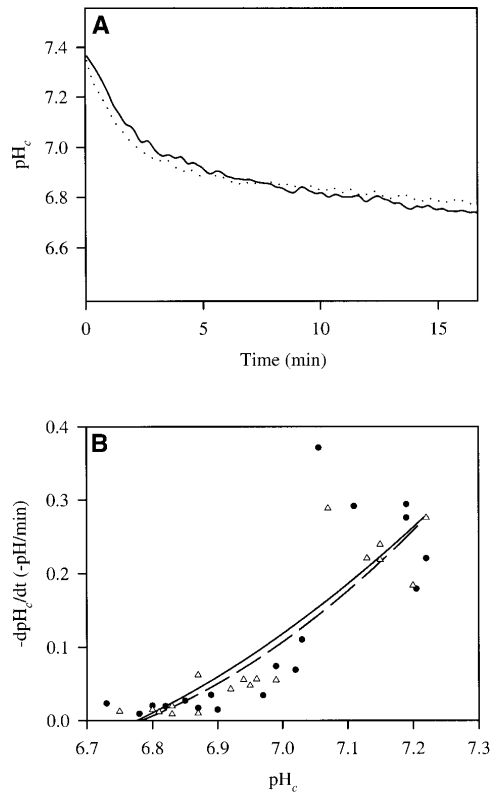

Fig. 3. Recovery from alkali load by Na^+ -independent Cl^-/HCO_3^- exchange. (A) Cells were alkali loaded with 60 mM acetate 15 min before experiments. Measurement of pH_c was performed in Ch/ HCO_3^- medium containing bafilomycin A_1 (15 nM) and amiloride (600 μ M). pH_c was maintained at 7.2 by controlling the CO_2 partial pressure. Control cells are denoted by a solid trace; dexamethasone-treated cells (10 nM, 20 h) are denoted by a dotted trace. (B) dpH_c/dt was calculated from measurements performed as in panel A. The data were taken from six traces from three separate experiments for control cells (filled circles) and dexamethasone-treated cells (open triangles), respectively. Lines for control cells (solid) and dexamethasone-treated cells (dashed) are regressions of the second order.

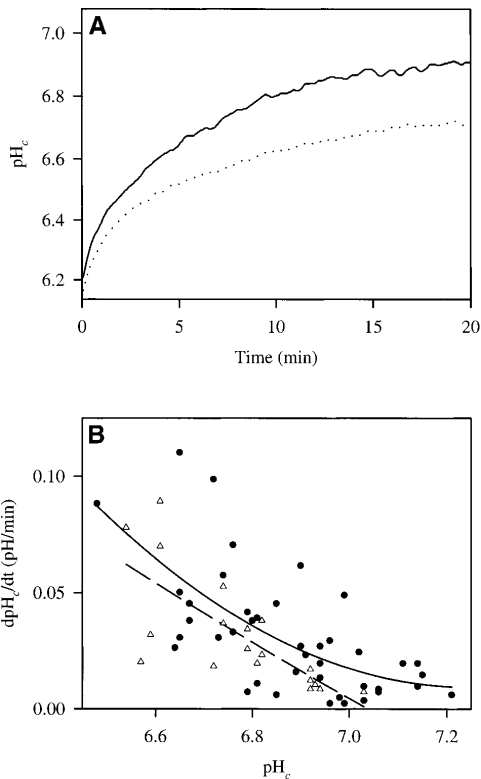

Fig. 4. Recovery from acid load by Na^+ -dependent $\text{Cl}^-/\text{HCO}_3^-$ exchange. (A) Cells were acid loaded with 20 mM NH_4Cl 15 min before experiments. Measurements of pH_c were performed in Na/HCO_3 medium ($\text{pH}_c = 7.2$) containing bafilomycin A_1 (15 nM) and amiloride (600 μM). Control cells are denoted by a solid trace; dexamethasone-treated cells (10 nM, 20 h) are denoted by a dotted trace. (B) dpH_c/dt was calculated and the data were taken from six traces from three separate experiments for control cells (filled circles) and dexamethasone-treated cells (open triangles), respectively. Lines for control cells (solid) and dexamethasone-treated cells (dashed) are regressions of the second order.

cells also attained a final pH_c lower than in control cells (Fig. 6, A and B). A lag period was often seen in these experiments before pH recovery was initiated, as noted previously [4]. Inhibition of the H^+ -ATPase by bafilomycin A_1 (15 nM) completely prevented recovery of pH_c in both control and dexamethasone-treated cells and an increase in the concentration of bafilomycin A_1 to 100 nM did not further inhibit the recovery of pH_c (Fig. 6A, lower solid traces).

Effects of dexamethasone on expression and localization of H^+ -ATPase

We next studied whether the reduced rate of pH recovery observed after treatment with dexamethasone was caused by a decreased expression or altered subcellular distribution of the proton pump. No effect on the expression of the 39-kDa pump subunit was detected after dexamethasone treatment for 20 h at concentrations up to 1000 nM (Fig. 7A). Also, when using this

antibody for immunocytochemistry, a predominantly punctuate staining pattern was observed (Fig. 7, B and C), consistent with the notion that the bulk of the proton pump is expressed in endosomal and lysosomal compartments. It is important to note that we could not detect an altered expression pattern after dexamethasone treatment by blinded inspection in the microscope (Fig. 7C). Immunofluorescence studies of the proton pump were also performed after acid loading of the cytosol using the same conditions as in Figure 6A. This treatment did not alter the expression pattern of neither control nor dexamethasone-treated cells (results not shown). It should be observed that any selective effect of dexamethasone on a low expression of the pump in the plasma membrane would be hard to detect by either immunofluorescence techniques or by analysis of purified plasma membrane fractions.

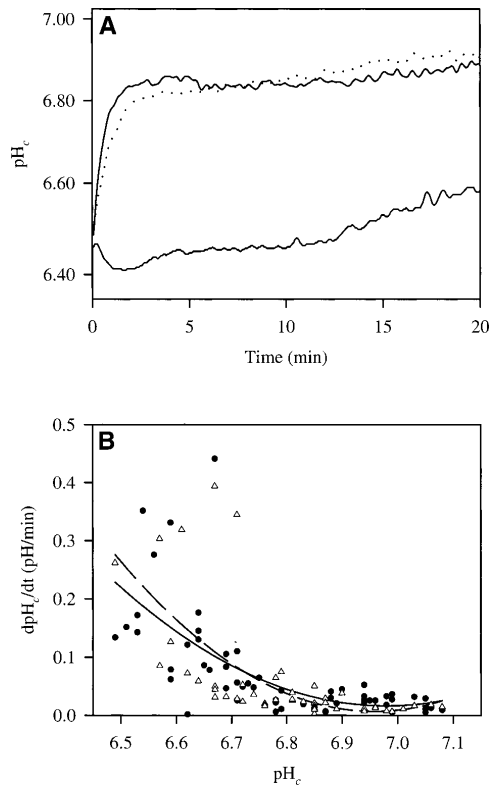

Fig. 5. Recovery from acid load by Na^+/H^+ exchange. (A) Measurements of pH_c in Na medium containing bafilomycin A_1 (100 nM) and DIDS (600 μM), $\text{pH}_c = 7.2$. Cells were acid loaded with NH_4Cl (20 mM, 15 min) before measurements. The upper solid trace denotes control cells; the dotted trace denotes dexamethasone-treated cells (10 nM, 20 h). The lower solid trace denotes control cells to which were added 600 μM amiloride. (B) dpH_c/dt was calculated and the data were taken from 46 traces from 17 separate experiments for control cells (filled circles) and dexamethasone-treated cells (open triangles), respectively. Lines for control cells (solid) and dexamethasone-treated cells (dashed) are regressions of the second order.

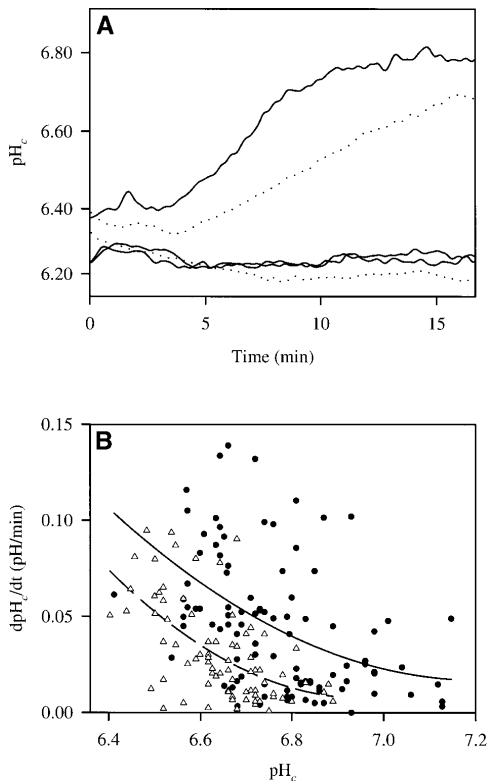

Fig. 6. Recovery from acid load by H^+ -ATPase. (A) pH_c was measured in Ch medium containing amiloride (600 μ M), $pH_c = 7.2$. Cells were acid-loaded with NH_4Cl (25 mM, 15 min). Solid traces show pH_c in control cells; dotted traces show pH_c in cells pretreated with dexamethasone (10 nM, 20 h). The two lower solid traces show experiments where bafilomycin A_1 (15 or 100 nM) was present. In the lower dotted trace, bafilomycin A_1 (15 nM) was present. dpH_c/dt was calculated and the data were taken from 46 traces from 36 and 30 separate experiments for control cells (filled circles) and dexamethasone-treated cells (open triangles), respectively. Lines for control cells (solid) and dexamethasone-treated cells (dashed) are regressions of the second order.

DISCUSSION

The mechanism of action of glucocorticoids involves their binding to an intracellular receptor, and the regulation of gene expression by this complex, causing either an increased or a decreased synthesis of many proteins. In the macrophage, dexamethasone has been shown to inhibit the production of certain cytokines [15], nitric oxide [16], the mobilization of arachidonate [17], phagocytosis [18], and lysosomal secretion [19]. The exact mechanisms by which dexamethasone inhibits these processes is not known, however. We hypothesized that some of the beneficial effects of glucocorticoids in the treatment of chronic inflammatory conditions could be ascribed to a lowering of pH_c in macrophages. A number of important cellular responses to inflammatory stimuli like the production of oxidative metabolites, lysosomal secretion, endocytosis [20] and cell movement [21] can in fact be modulated by small

changes in pH_c . The mechanisms responsible for pH regulation in the macrophage are depicted in **Figure 8** and briefly discussed below.

A vacuolar-type H^+ -ATPase is present in many internal membranes of eukaryotic cells and can acidify compartments that have endocytic, biosynthetic, or storage functions. This H^+ -ATPase consists of two large subunit complexes, one of which (the V_0 -complex) forms a proton-translocating pore in the membrane. The other complex (V_1) can hydrolyze ATP and is thought to attach to the V_0 -complex upon activation of the

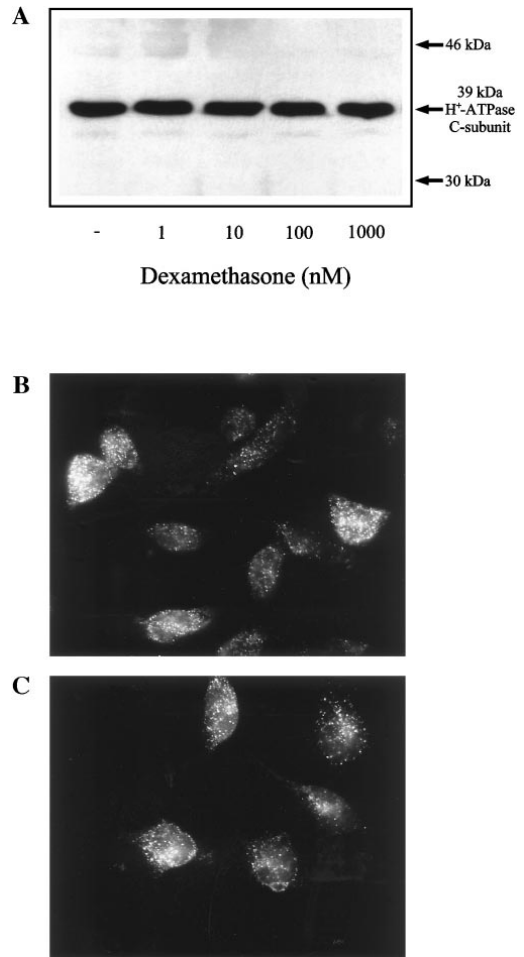

Fig. 7. Effect of dexamethasone on expression and localization of the 39-kDa C-subunit (A) Western blot showing the expression of the 39-kDa C-subunit in macrophages after a 20-h exposure to increasing concentrations of dexamethasone, as indicated. These results are representative of three separate experiments. Densitometric scanning of the 39-kDa band showed that dexamethasone treatment had no significant effect on its expression. (B, C) Permeabilized macrophages stained with an antibody to the 39-kDa C-subunit, as described in Materials and Methods. Panel B shows control cells and panel C shows cells cultured in presence of 100 nM dexamethasone for 20 h. These results are representative of three separate experiments.

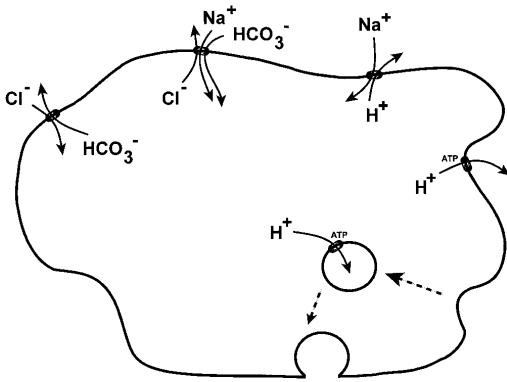

Fig. 8. Schematic view of pH-regulatory mechanisms in mouse peritoneal macrophages. Solid arrows indicate ion transport, whereas dotted arrows indicate a putative shuttle of protons through the recycling of vesicular compartments containing the proton pump. It should be noted that the stoichiometry of the Na^+ -dependent $\text{Cl}^-/\text{HCO}_3^-$ -transport could differ, and that the proton conductance of activated phagocytes and lactate transporters are not depicted.

proton pump [for review see refs. 22, 23]. An involvement of this vacuolar type of proton-translocating ATPase also in the regulation of cytosolic pH has been demonstrated in several cell types [23–26]. In macrophages, the H^+ -ATPase operates in the physiological pH range and has been shown to be important for maintenance of baseline pH_c [27]. It is activated upon intracellular acid loads and it can be inhibited by plasma membrane hyperpolarization [5]. Also, the proton pump is activated by stimulators of protein kinase C [28]. The regulation of the activity of the proton pump is poorly understood but phosphorylation of H^+ -ATPase subunits [29] and stimulatory and inhibitory accessory proteins have been described in other cell types [30, 31]. Furthermore, a mobilization of H^+ -ATPase from intracellular stores to the plasma membrane has been suggested to occur in cells from turtle bladder [32], medullary collecting duct cells [33], and in neutrophils [34], but such a mechanism has not yet been demonstrated in macrophages. At the low pH of an inflammatory lesion, phagocyte function could depend upon ATP-dependent extrusion of protons because other pH-regulatory mechanisms, like the Na^+/H^+ -exchanger and the HCO_3^- -dependent exchangers, would be inhibited due to unfavorable proton and bicarbonate gradients [2, 8].

In a physiological buffer containing bicarbonate, macrophages utilize two additional mechanisms for the regulation of their resting cytosolic pH. The alkalinizing Na^+ -dependent $\text{Cl}^-/\text{HCO}_3^-$ exchanger is activated by cytosolic acidification, whereas the acidifying Na^+ -independent $\text{Cl}^-/\text{HCO}_3^-$ exchanger is activated by cytosolic alkalization [3].

Na^+/H^+ -exchange, the main mechanism for regulation of pH_c in many cell types, is predominantly expressed as the NHE-1 isoform in macrophages [35]. This mechanism is not active in the range from pH 6.8 up to baseline pH in the quiescent macrophage, but is activated upon larger acid loading of the cytosol [5]. This occurs through a pH-sensitive allosteric modification of a site in its cytosolic domain [36]. The cytosolic pH level at which the NHE-1 becomes activated by

protons is called the set-point of the exchanger. Growth factors can induce an alkaline shift of pH_c by altering this setpoint, and phosphorylation of serine residues and/or the binding of calmodulin to the cytosolic domain of the exchanger have been suggested to regulate its activity [for review see ref. 37].

Another alkalinizing pH-regulatory mechanism that is normally quiescent is an H^+ conductance that is activated during the oxidative burst of phagocytic cells. This mechanism is gated by depolarization of the plasma membrane and modulated by the proton concentration in the cytosol and extracellular environment [38].

The main finding of the present study is that dexamethasone treatment lowers pH_c in mouse macrophages. The decrease in pH_c appeared gradually during treatment, was maximal at 10 nM dexamethasone, and was most likely glucocorticoid receptor-mediated because it was observed not to occur in the presence of RU-38486, an antagonist of the glucocorticoid receptor [39, 40]. By studying each pH-regulatory mechanism in isolation we investigated possible mechanisms by which dexamethasone might alter pH_c . Cellular buffer capacity was found not to differ between dexamethasone-treated and control cells. Nor did the rate of production of metabolic acids differ to the extent that it was likely to account for the observed difference in pH_c . Furthermore, we found that the activity of the Na^+/H^+ -exchanger in macrophages was not altered by dexamethasone treatment. Dexamethasone has been shown to increase the expression of NHE-3 but not NHE-1 isoforms of the Na^+/H^+ exchanger in various tissues [41, 42] and to stimulate the activity of Na^+/H^+ exchange in OKP cells [43].

The dexamethasone-induced lowering of pH_c was evident when pH measurements were performed in HCO_3^- -containing media (Fig. 1A), suggesting an effect on HCO_3^- -dependent mechanisms. Altered recovery from an acid load in Na/HCO_3 medium was demonstrated and the pH levels after 20 min of pH recovery differed with and without dexamethasone treatment. However, at a reduced pH_c of an inflammatory lesion, the activity of the Na^+ -dependent $\text{Cl}^-/\text{HCO}_3^-$ exchanger would tend to be inhibited due to a reduced bicarbonate content [2]. The proton pump is therefore more likely to be responsible for any difference in pH_c caused by dexamethasone at acidic pH_c because it is fueled by ATP and possibly less sensitive to external acidification.

Part of the effect of dexamethasone on the cytosolic pH of macrophages was caused by inhibition of the proton pump. Both the activity and the operational range of this mechanism were reduced in cells treated with dexamethasone. To our knowledge, effects of glucocorticoids on the activity and/or expression of the H^+ -ATPase have not previously been described. Our initial attempts to define the mechanisms causing the suppression of proton pump activity did not show an altered expression or subcellular localization of the 39-kDa proton pump subunit. However, dexamethasone-induced alterations in the assembly of the V_0/V_1 complexes or expression of pump-regulatory factors like various upstream kinases/phosphatases could not be ruled out. Neither could a selective effect of dexamethasone on some other proton pump subunit be excluded. It is also conceivable that the pump-mediated proton transport occurs into pinosomal compartments rather than directly across the

plasma membrane. If such tentative compartments recycle rapidly, they could represent a functional equivalent to pumps actually present in the plasma membrane, and would be another target for dexamethasone-mediated regulation of proton extrusion. These possibilities are currently under investigation. Regardless of the mechanism, the reduced activity of the proton pump caused by corticosteroids could have important pathophysiological consequences. It has been claimed that the plasma membrane-localized H⁺-ATPase can operate to acidify the microenvironment of macrophages [44, 45] and that this might increase the activity of secreted acid hydrolases. By inhibiting the H⁺-ATPase, dexamethasone could act to reduce the extracellular acidity locally, thus influencing the effects of released mediators of inflammation.

ACKNOWLEDGMENTS

This work was supported in part by the Swedish Medical Research Council (5410, 11349, 11385, VT623, X0066, V2307), the Wenner-Gren Center Foundation, the Crafoord Foundation, the Albert Pahlson Foundation, the Greta and Johan Kock Foundations, King Gustaf V 80-Year Foundation, the Thelma Zoëga Foundation, the Magnus Bergvall Foundation, the Alfred Österlund Foundation, and Kungliga Fysiografiska Sällskapet, Lund.

REFERENCES

- Gallin, J. I., Goldstein, I. M., Snyderman, R. (1992) *Inflammation. Basic Principles and Clinical Correlates*. New York: Raven.
- Alfaro, V., Ródenas, J., Pesquero, J., Mitjavila, M. T., Palacios, L., Carbonell, T. (1996) Factors influencing the acid-base changes in the air-pouch exudate following carrageenan induced inflammation in rats. *Inflamm. Res.* 45, 405–411.
- Tapper, H., Sundler, R. (1992) Cytosolic pH regulation in mouse macrophages. Characteristics of HCO₃⁻-dependent mechanisms. *Biochem. J.* 281 (Pt. 1), 239–244.
- Tapper, H., Sundler, R. (1992) Cytosolic pH regulation in mouse macrophages. Proton extrusion by plasma-membrane-localized H⁺-ATPase. *Biochem. J.* 281 (Pt. 1), 245–250.
- Bidani, A., Brown, S. E., Heming, T. A. (1994) pH_i regulation in alveolar macrophages: relative roles of Na⁺-H⁺ antiporter and H⁺-ATPase. *Am. J. Physiol.* 266, L681–L688.
- Bidani, A., Heming, T. A. (1995) Effects of bafilomycin A₁ on functional capabilities of LPS-activated alveolar macrophages. *J. Leukoc. Biol.* 57, 275–281.
- Tapper, H., Sundler, R. (1990) Role of lysosomal and cytosolic pH in the regulation of macrophage lysosomal enzyme secretion. *Biochem. J.* 272, 407–414.
- Swallow, C. J., Grinstein, S., Sudsbury, R. A., Rotstein, O. D. (1990) Modulation of the macrophage respiratory burst by an acidic environment: the critical role of cytoplasmic pH regulation by proton extrusion pumps. *Surgery* 108, 363–369.
- Madshus, I. H. (1988) Regulation of intracellular pH in eukaryotic cells. *Biochem. J.* 250, 1–8.
- Murguía, J. R., De Vries, L., Gomez-García, L., Schönthal, A., Perona, R. (1995) Activation of the c-fos promoter by increased internal pH. *J. Cell Biochem.* 57, 630–640.
- Conboy, I. M., Manoli, D., Mhaikar, V., Jones, P. P. (1999) Calcineurin and vacuolar-type H⁺-ATPase modulate macrophage effector functions. *Proc. Natl. Acad. Sci. USA* 96, 6324–6329.
- Gottlieb, R. A., Giesing, H. A., Zhu, J. Y., Engler, R. L., Babior, B. M. (1995) Cell acidification in apoptosis: granulocyte colony-stimulating factor delays programmed cell death in neutrophils by up-regulating the vacuolar H⁺-ATPase. *Proc. Natl. Acad. Sci. USA* 92, 5965–5968.
- Wenzl, E., Machen, T. E. (1989) Intracellular pH dependence of buffer capacity and anion exchange in the parietal cell. *Am. J. Physiol.* 257, G741–G747.
- Laemmli, U. K. (1970) Cleavage of structural proteins during the assembly of the head of bacteriophage T4. *Nature* 227, 680–685.
- Goldstein, R. A., Bowen, L. D., Fauci, A. S. (1992) Adrenal corticosteroids. In *Inflammation: Basic Principles and Clinical Correlates* (J. I. Gallin, I. M. Goldstein, and R. Snyderman, eds.), New York: Raven, 1061–1081.
- Ryoyama, K., Nomura, T., Nakamura, S. (1993) Inhibition of macrophage nitric oxide production by arachidonate-cascade inhibitors. *Cancer Immunol. Immunother.* 37, 385–391.
- Gewert, K., Sundler, R. (1995) Dexamethasone down-regulates the 85 kDa phospholipase A2 in mouse macrophages and suppresses its activation. *Biochem. J.* 307 (Pt. 2), 499–504.
- Ragsdale, R. L., Grasso, R. J. (1989) An improved spectrofluorometric assay for quantitating yeast phagocytosis in cultures of murine peritoneal macrophages. *J. Immunol. Meth.* 123, 259–267.
- Gewert, K., Tapper, H., Naulclér, C., Sundler, R. (1995) Dexamethasone downregulates lysosomal secretion in mouse macrophages: involvement of signaling through protein kinase C. *J. Inflamm.* 47, 115–125.
- Cosson, P., de Curtis, I., Pouyssegur, J., Griffiths, G., Davoust, J. (1989) Low cytoplasmic pH inhibits endocytosis and transport from the trans-Golgi network to the cell surface. *J. Cell Biol.* 108, 377–387.
- Simchowitz, L., Cragoe, E. J. J. (1986) Regulation of human neutrophil chemotaxis by intracellular pH. *J. Biol. Chem.* 261, 6492–6500.
- Finbow, M. E., Harrison, M. A. (1997) The vacuolar H⁺-ATPase: a universal proton pump of eukaryotes. *Biochem. J.* 324 (Pt. 3), 697–712.
- Forgac, M. (1998) Structure, function and regulation of the vacuolar H⁺-ATPases. *FEBS Lett.* 440, 258–263.
- Chatterjee, D., Chakraborty, M., Leit, M., Neff, L., Jamsa-Kellokumpu, S., Fuchs, R., Baron, R. (1992) Sensitivity to vanadate and isoforms of subunits A and B distinguish the osteoclast proton pump from other vacuolar H⁺-ATPases. *Proc. Natl. Acad. Sci. USA* 89, 6257–6261.
- Grinstein, S., Nanda, A., Lukacs, G., Rotstein, O. (1992) V-ATPases in phagocytic cells. *J. Exp. Biol.* 172, 179–192.
- Gluck, S. L. (1992) The structure and biochemistry of the vacuolar H⁺-ATPase in proximal and distal urinary acidification. *J. Bioenerg. Biomembr.* 24, 351–359.
- Swallow, C. J., Grinstein, S., Rotstein, O. D. (1988) Cytoplasmic pH regulation in macrophages by an ATP-dependent and *N,N*-dicyclohexylcarbodiimide-sensitive mechanism. Possible involvement of a plasma membrane proton pump. *J. Biol. Chem.* 263, 19558–19563.
- Nanda, A., Gukovskaya, A., Tseng, J., Grinstein, S. (1992) Activation of vacuolar-type proton pumps by protein kinase C. Role in neutrophil pH regulation. *J. Biol. Chem.* 267, 22740–22746.
- Myers, M., Forgac, M. (1993) The coated vesicle vacuolar H⁺-ATPase associates with and is phosphorylated by the 50-kDa polypeptide of the clathrin assembly protein AP-2. *J. Biol. Chem.* 268, 9184–9186.
- Zhang, K., Wang, Z. Q., Gluck, S. (1992) A cytosolic inhibitor of vacuolar H⁺-ATPases from mammalian kidney. *J. Biol. Chem.* 267, 14539–14542.
- Zhang, K., Wang, Z. Q., Gluck, S. (1992) Identification and partial purification of a cytosolic activator of vacuolar H⁺-ATPases from mammalian kidney. *J. Biol. Chem.* 267, 9701–9705.
- Gluck, S., Cannon, C., Al-Awqati, Q. (1982) Exocytosis regulates urinary acidification in turtle bladder by rapid insertion of H⁺ pumps into the luminal membrane. *Proc. Natl. Acad. Sci. USA* 79, 4327–4331.
- Alexander, E. A., Brown, D., Shih, T., McKee, M., Schwartz, J. H. (1999) Effect of acidification on the location of H⁺-ATPase in cultured inner medullary collecting duct cells. *Am. J. Physiol.* 276, C758–C763.
- Nanda, A., Brumell, J. H., Nordström, T., Kjeldsen, L., Sengelöv, H., Borregaard, N., Rotstein, O. D., Grinstein, S. (1996) Activation of proton pumping in human neutrophils occurs by exocytosis of vesicles bearing vacuolar-type H⁺-ATPases. *J. Biol. Chem.* 271, 15963–15970.
- Demareux, N., Orłowski, J., Brisseau, G., Woodside, M., Grinstein, S. (1995) The mammalian Na⁺/H⁺ antiporters NHE-1, NHE-2, and NHE-3 are electroneutral and voltage independent, but can couple to an H⁺ conductance. *J. Gen. Physiol.* 106, 85–111.
- Aronson, P. S., Nee, J., Suhm, M. A. (1982) Modifier role of internal H⁺ in activating the Na⁺-H⁺ exchanger in renal microvillus membrane vesicles. *Nature* 299, 161–163.
- Orłowski, J., Grinstein, S. (1997) Na⁺/H⁺ exchangers of mammalian cells. *J. Biol. Chem.* 272, 22373–22376.
- Lukacs, G. L., Kapus, A., Nanda, A., Romanek, R., Grinstein, S. (1993) Proton conductance of the plasma membrane: properties, regulation, and functional role. *Am. J. Physiol.* 265, C3–C14.
- Chasserot-Golaz, S., Beck, G. (1984) An approach to the mechanism of the potent antigluco-corticoid: 17β-hydroxy-11β-4-dimethylaminophenyl-17α-propynyl-estra-4,9-dien-3-one. *J. Steroid Biochem.* 21, 585–591.

40. Gagne, D., Pons, M., Philibert, D. (1985) RU 38486: a potent antiglucocorticoid in vitro and in vivo. *J. Steroid Biochem.* 23, 247-251.
41. Baum, M., Moe, O. W., Gentry, D. L., Alpern, R. J. (1994) Effect of glucocorticoids on renal cortical NHE-3 and NHE-1 mRNA. *Am. J. Physiol.* 267, F437-F442.
42. Cho, J. H., Musch, M. W., DePaoli, A. M., Bookstein, C. M., Xie, Y., Burant, C. F., Rao, M. C., Chang, E. B. (1994) Glucocorticoids regulate Na^+/H^+ exchange expression and activity in a region- and tissue-specific manner. *Am. J. Physiol.* 267, C796-C803.
43. Baum, M., Cano, A., Alpern, R. J. (1993) Glucocorticoids stimulate Na^+/H^+ antiporter in OKP cells. *Am. J. Physiol.* 264, F1027-F1031.
44. Silver, I. A., Murrills, R. J., Etherington, D. J. (1988) Microelectrode studies on the acid microenvironment beneath adherent macrophages and osteoclasts. *Exp. Cell Res.* 175, 266-276.
45. Loike, J. D., Silverstein, R., Wright, S. D., Weitz, J. I., Huang, A. J., Silverstein, S. C. (1992) The role of protected extracellular compartments in interactions between leukocytes and platelets, and fibrin/fibrinogen matrices. *Ann. NY Acad. Sci.* 667, 163-172.



KEYWORDS:

dexamethasone
downregulation
lysosomal secretion
mouse macrophages
protein kinase C
signaling

ABBREVIATIONS:

BCECF-AM 2',7'-bis(carboxyethyl)-5(6)-carboxyfluorescein tetra-acetoxymethyl ester
dex dexamethasone
FD fluorescein isothiocyanate-conjugated dextran
NAG *N*-acetyl- β -D-glucosaminidase (EC 3.2.1.30)
PKC protein kinase C
PMA 4 β -phorbol 12-myristate 13-acetate.

Contributed by M. Jäättelä.

Submitted for publication July 5, 1996; accepted July 9, 1996.

Address reprint requests to Roger Sundler, Department of Cell and Molecular Biology, Lund University, P.O. Box 94, S-221 00 Lund, Sweden.

Hans Tapper is now at Division of Cell Biology, Research Institute, Hospital for Sick Children, 555 University Avenue, Toronto, Ontario M5G 1X8, Canada.

This work was supported by grants from the Swedish Medical Research Council (5410, 11349), the Albert Pähls-son Foundation, the Greta and Johan Kock Foundations, King Gustaf V 80-Year Foundation, the Thelma Zoéga Foundation, the Alfred Österlund Foundation, the Wenner-Gren Center Foundation, and the Medical Faculty, Lund University.

© 1997 Wiley-Liss, Inc.

RESEARCH ARTICLE

Dexamethasone Downregulates Lysosomal Secretion in Mouse Macrophages: Involvement of Signaling Through Protein Kinase C

Karin Gewert, Hans Tapper, Claes Nauclicr, and Roger Sundler

Department of Cell and Molecular Biology, Section for Molecular Pathogenesis, Lund University, Lund, Sweden

*Spectrofluorimetric methods were used to investigate the effects of dexamethasone (dex) on cytosolic and lysosomal pH and on macrophage secretion of lysosomal contents. Secretion of *N*-acetyl- β -D-glucosaminidase (NAG) in response to zymosan particles, lysosomotropic methylamine, or the H^+ -ATPase inhibitor bafilomycin A_1 was inhibited by pretreatment with dex. The inhibition was not reversed by mannan and was seen also when secretion of preloaded fluorescein-labeled dextran was monitored, demonstrating that dex did not exert its effect by enhancing the reuptake of lysosomal enzyme.*

The binding of zymosan particles to macrophages was diminished after dex treatment, as was the zymosan-induced phospholipase C activation. However, the decreased binding of zymosan did not alone account for the inhibition of phospholipase C activation. Also, cytosolic pH was lowered by dex treatment. This might contribute to the inhibition of lysosomal secretion, but restoration of cytosolic pH by an increase in extracellular pH did not restore the secretory response.

Lysosomal secretion induced by a combination of protein kinase C (PKC)-activating phorbol ester and methylamine was more resistant to dex than secretion induced by methylamine alone, or other secretagogues. We interpret this, together with previous data, to indicate that dex inhibits macrophage lysosomal secretion by attenuating one or more step(s) in a PKC-mediated signaling pathway necessary for the secretory response. © 1997 Wiley-Liss, Inc.

INTRODUCTION

Mouse peritoneal macrophages can secrete their lysosomal content in response to various agonists [1], some of which also give rise to an inflammatory reaction when injected into experimental animals. Exocytosis of preformed lysosomal enzyme is a regulated secretory event. An increase in lysosomal pH is sufficient to initiate lysosomal enzyme secretion [2]. Methylamine, H^+ -translocating ionophores (monensin and nigericin), the H^+ -ATPase inhibitor bafilomycin A_1 , and zymosan particles have all been shown to elevate lysosomal pH [2–7]. The stimulus-induced lysosomal secretion is also modulated by cytosolic pH, being enhanced by cytosolic alkalization and inhibited by acidification [2]. The lysosomal secretory response is likely to be part of an inflammatory response defending the host against infectious agents and may also play a role in non-infectious inflammatory conditions.

Zymosan is a carbohydrate-rich cell wall preparation derived from the yeast *Saccharomyces cerevisiae*, and consists mainly of α -mannan and β -glucan [8]. Mouse peritoneal macrophages have been shown to express both mannose and β -glucan receptors [9–13]. Triggering of lysosomal secretion by zymosan particles is β -glucan receptor-mediated [14]. Furthermore, the binding and phagocytosis of zymosan is also β -glucan receptor-dependent and not solely dependent on mannose receptors or opsonization by complement [15,16]. Zymosan particles have earlier been demonstrated to induce hydrolysis of phosphoinositides [17], thereby generating inositolphosphates and diacylglycerol.

Glucocorticoids are used therapeutically in chronic inflammatory diseases and suppress the production and release of a number of specific mediators of inflammation such as proinflammatory cytokines and eicosanoids [18]. Werb et al. [19] demonstrated that macrophages possess high affinity glucocorticoid receptors but still the mechanism for the anti-inflammatory effects of glucocorticoids is not fully understood. Dex selectively inhibits the release of acid hydrolases from mouse peritoneal macrophages [20]. It has been suggested that the effect of dex on lysosomal secretion is at the level of expression of receptors. Goldman [16] found a suppressed expression of β -glucan receptors in macrophages after dex treatment. However, other studies have indicated that

dex increases the expression of β -glucan receptors [21] in mononuclear phagocytes and also of mannose receptors in macrophages [22]. Effects on the relative expression of mannose and glucan receptors of the macrophage would be expected to affect its ability to interact with zymosan particles and the cellular signals generated by such interaction. It has been suggested that dex reduces the amount of lysosomal enzymes found extracellularly after zymosan treatment by increasing the uptake of secreted enzyme via mannose receptors [22]. In the present study we investigated by which mechanism(s) glucocorticoids inhibit lysosomal secretion and show that the effect of dex is not due to increased reuptake of secreted enzyme or to effects on lysosomal or cytosolic pH. Instead we suggest that dex inhibits lysosomal secretion by interfering with PKC-mediated signaling necessary for the secretory response.

MATERIALS AND METHODS

Materials

4-Methylumbelliferyl *N*-acetyl- β -D-glucosaminide, FD (average Mr = 40,500; 9 mmol of fluorescein isothiocyanate/mol of glucose residue), zymosan, PMA, nigericin, and monensin were from Sigma (St. Louis, MO). Methylammonium chloride was obtained from Merck (Darmstadt, Germany). Okadaic acid was from BioZac (New Boston St. Woburn, MA). *Myo*[2- 3H]inositol was purchased from Amersham International (Buckinghamshire, UK). Resin AG 1-X8 was bought from BioRad (Richmond, CA). Bafilomycin A_1 was kindly provided by Prof. K. Altendorf (Osnabrück, Germany). BCECF-AM and fluorescein-conjugated zymosan were from Molecular Probes, Inc. (Eugene, OR). RU38486 was a gift from Roussel Uclaf (Paris, France). All materials for cell culture were purchased from Flow Laboratories (Costa Mesa, CA).

Experimental Media

Na-based solution with nominal bicarbonate (Na medium) contained NaCl, 127 mM; KH_2PO_4 , 1.2 mM; KCl, 5.4 mM; $MgSO_4$, 0.8 mM; $CaCl_2$, 1.8 mM; glucose, 5.6 mM; and HEPES, 10 mM. If not otherwise stated, pH was adjusted to 7.20 with

NaOH. K medium contained KCl, 127 mM; NaH_2PO_4 , 1.2 mM; NaCl, 5.4 mM; MgSO_4 , 0.8 mM; CaCl_2 , 1.8 mM; glucose, 5.6 mM; and Hepes, 10 mM. If not otherwise stated, pH was adjusted to 7.20 with KOH. LiCl medium contained LiCl, 150 mM; KCl, 5.4 mM; NaH_2PO_4 , 1.0 mM; MgCl_2 , 0.8 mM; CaCl_2 , 1.8 mM; glucose, 5.6 mM; Hepes, 10 mM; and 0.15% (w/v) NaHCO_3 .

Macrophage Culture and Stimulation

Peritoneal lavage was performed to harvest resident cells from female outbred NMRI mice (Bommice, Copenhagen, Denmark) using Medium 199 containing 1% heat-inactivated fetal bovine serum. Peritoneal cells were allowed to adhere to 6-well, 35 mm diameter tissue-culture dishes in a humidified atmosphere of 5% CO_2 in air at 37°C. For measurement of lysosomal or cytosolic pH, the cells were allowed to adhere to 12 mm diameter coverglasses. Non-adherent cells were removed after 2 hr and to each well was added 2 ml of Medium 199 containing 10% serum. After further culture for 20 hr, the medium was exchanged for Na medium under atmospheric CO_2 partial pressure. The cells were allowed to equilibrate in this medium for 15 min before addition of stimuli.

Assay of NAG Secretion

At the end of the experiments, the culture media were collected and the cells were lysed with 1 ml of 0.1% (w/v) Triton X-100 and scraped off with a teflon policeman. Triton X-100 was added also to the media samples to achieve the same final concentration of Triton X-100. All samples were centrifuged (2,500g, 5 min) and the supernatants were collected. NAG was determined as described earlier [2] at 37°C in a SLM spectrofluorimeter (model 8000C) with wavelengths for excitation and emission set at 341 and 447 nm, respectively.

Corrections for release of NAG from control cells (approximately 2.0%) were made in all experiments. For none of the experimental conditions used was the level of lactate dehydrogenase (EC 1.1.1.27) in the media elevated, and this was taken as an indication of plasma membrane integrity.

Measurement of Cytosolic and Lysosomal pH

The cells were equilibrated in Na medium under atmospheric CO_2 partial pressure 30 min prior

to experiments. BCECF-AM was added to the medium 10 min before experiments and cytosolic pH was monitored as described earlier [2]. Cells used for measurement of lysosomal pH were cultured for 20 hr in Medium 199 containing FD (0.5 mg/ml). FD-free medium was applied 30 min prior to experiments. Measurements of cytosolic and lysosomal pH were performed in a SLM 8000 spectrofluorimeter as described earlier [2]. Cells adherent to coverglasses were placed in a cuvette holder and were constantly perfused with medium (37°C) at a rate of 1 ml/min. All stimuli were added by perfusion at a 10-fold increased flow rate.

Assay of FD Release

Macrophages were cultured as described above (20 hr) except for the inclusion of FD (0.5 mg/ml) in the Medium 199 containing 10% serum. Stimuli were added after 15 min incubation in FD-free Na medium. After the experiments, the media were collected and cells lysed as described for the assay of NAG secretion. Media and cell lysates (0.7 ml) were diluted with 0.5 ml Na medium, pH 7.2, and used for quantification of FD release at 497 nm (excitation) and 518 nm (emission).

Determination of Zymosan Binding

Fluorescein-conjugated zymosan particles were added to cells on coverglasses in most cases at a particle/cell ratio of 50 (corresponding to 200 μg zymosan/ml). After 15 min (Na medium pH 7.2) coverglasses were placed on ice and non-bound zymosan was removed by four washes with cold Na medium. Coverglasses were then observed in a fluorescence microscope (Nikon microphot-FXA/SA) and three different areas of each coverglass were randomly selected and photographed. The number of bound zymosan particles per ingested cell was determined by fluorescence and phase contrast.

Measurement of Inositol Phosphate Formation

To macrophages cultured in 6-well culture dishes 10 μCi $\text{myo}[2\text{-}^3\text{H}]\text{inositol}$ was added. After 20 hr the cells were washed thoroughly and incubated for 30 min in a mixture (2:1, v/v) of serum-free Medium 199 and LiCl medium. The total cellular incorporation of [^3H]inositol was somewhat less ($63 \pm 5\%$ of control; mean \pm S.E.M., $n = 5$)

in cells simultaneously treated with dex, but the relative radioactivity of the different inositol phosphates was unaffected. After one further change to fresh medium cells were stimulated for 15 min with zymosan particles (70 or 200 $\mu\text{g}/\text{ml}$). Dishes were then placed on ice and the cells were harvested with a teflon policeman in 1.0 ml of 50 mM HCl. Lipids were extracted with 6 ml chloroform/methanol (1:1 v/v) containing 0.05% (w/v) of 2,6-di-*t*-butyl-*p*-cresol and lipid standards. After two-phase partitioning the upper phase was run on an ion exchange column (AG 1-X8, BioRad). Inositol was eluted with water while glycerophosphoinositol, cyclic inositol monophosphate, inositol monophosphate(s), bisphosphate(s), and triphosphate(s) were eluted with 0.025, 0.1, 0.2, 0.5, and 1.0 M ammonium formate, respectively, quantified by radioactivity determination, and the data were then normalized to compensate for differences in total cellular labeling. This analytic procedure is similar to that described earlier [17].

RESULTS

Inhibitory Effect of Dex on Lysosomal Enzyme Secretion

Pretreatment of mouse peritoneal macrophages with dex (10 nM) for 20 hr inhibited their secretion of NAG in response to a number of stimuli. The secretory response to the particulate stimulus zymosan, the weak base methylamine, or the H^+ -ATPase inhibitor bafilomycin A_1 was reduced by 60–70%, while the response to the Na^+ - and H^+ -selective ionophore monensin was somewhat less affected (Fig. 1). Since the inhibition was in all cases partial, the dose dependence for the effect of dex was investigated. Methylamine-induced NAG secretion was inhibited in a dose-dependent manner (Fig. 2) and the inhibition was virtually complete at 0.1 μM dex. Very similar dose dependencies were observed also when zymosan or bafilomycin A_1 was used as stimulus (not shown). The inhibitory effect on the secretory response also increased with time of pretreatment with dex (Fig. 3). When either methylamine or bafilomycin A_1 was used as stimulus, significant inhibition ($P < 0.01$) occurred already within 4 hr, this was not the case when zymosan was the stimulus. As dex pretreatment was extended overnight, a similar and extensive inhibition of the secretory response to all three stimuli was seen (Fig. 3).

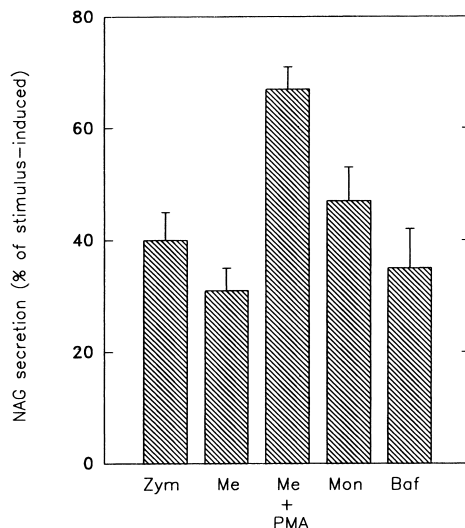

FIGURE 1

Dex inhibition of stimulus-induced release of NAG. Macrophages were cultured for 20 hr with or without dex (10 nM). The cells were stimulated during 1 hr with zymosan (200 $\mu\text{g}/\text{ml}$), methylamine (10 nM), PMA (80 nM), monensin (1 μM), or bafilomycin A_1 (100 nM). The experiments were performed in Na medium at pH 7.2. The secretion of NAG by cells not exposed to dex was set to 100% and amounted to 19 ± 2% (zymosan), 31 ± 3% (methylamine), 49 ± 3% (methylamine and PMA), 16 ± 3% (monensin), and 16 ± 2% (bafilomycin A_1) of total cellular NAG. Data are means ± S.E.M; n = 9–28.

PMA, a direct activator of most isoforms of PKC, is by itself not an effective inducer of NAG secretion in mouse macrophages. However, a combination of PMA with either methylamine or monensin leads to a synergistic increase in the secretory response [7]. NAG secretion induced by a combination of PMA and methylamine was not inhibited by dex to the same extent as when triggered by methylamine alone (Fig. 1), and remained incompletely inhibited even at 1 μM dex (Fig. 2).

Effect of Glucocorticoid Antagonist

The glucocorticoid antagonist RU38486 [23,24] partially reversed the inhibitory effects of dex (10 nM, 20 hr) on zymosan-, methylamine-, and monensin-induced NAG secretion at equimo-

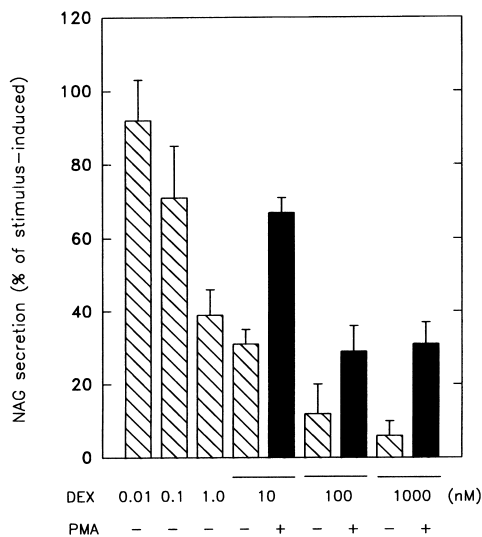

FIGURE 2

Dose dependence of dex-mediated inhibition of methylamine-stimulated NAG secretion. Treatment with or without the indicated concentration of dex was for 20 hr. The cells were stimulated for 1 hr with methylamine (10 mM) or with a combination of methylamine (10 mM) and PMA (80 nM) in Na medium at pH 7.2. The results presented are means \pm S.E.M. from 4–28 independent experiments. The NAG secretion by cells not treated with dex was set to 100% and amounted to values presented in the legend to Figure 1.

lar concentration. When present in a 100-fold excess, RU38486 completely restored the stimulus-induced secretion independently of stimulus used (not shown). The total NAG activity in the cultures was similar to control after treatment with either dex, RU38486, or both.

Effect of Dex on Lysosomal and Cytosolic pH

A decrease in cytosolic pH was caused by dex (Nauc er et al., manuscript in preparation). This decrease in cytosolic pH was maximal after 4 hr and could be prevented by RU38486 (1 μ M). Monensin and methylamine both cause a rapid alkalization of cytosolic pH [2] and both agents abolished the difference in cytosolic pH between untreated and dex-treated cells (Fig. 4a,b). Monensin and methylamine also rapidly alkalized lyso-

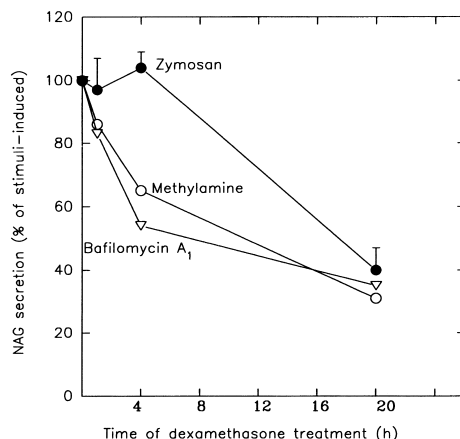

FIGURE 3

Time dependence of dex-induced inhibition of NAG secretion. Treatment with or without 10 nM dex was for 1, 4, or 20 hr, after which the cells were stimulated for 1 hr with zymosan (200 μ g/ml), methylamine (10 mM), or bafilomycin A₁ (100 nM) in Na medium at pH 7.2. The results are means \pm S.E.M. from 3–8 independent experiments. The NAG secretion by cells not treated with dex was set to 100% and amounted to values presented in the legend to Figure 1.

somal pH to a similar extent in both control cells and dex-treated cells (Fig. 4e,f).

Zymosan treatment caused an elevation of cytosolic pH in dex-treated cells (Fig. 4c). As reported earlier [7], zymosan elevated lysosomal pH in untreated cells; however, it did not do so in dex-treated cells (Fig. 4g). Bafilomycin A₁ alkalized lysosomal pH both in dex-treated and in untreated cells (Fig. 4h). The initial difference in cytosolic pH between untreated and dex-treated cells remained constant during stimulation only in the case of bafilomycin A₁ (Fig. 4d). The minor differences in lysosomal pH between control and dex-treated cells (Fig. 4e,f,h) were not consistent, in contrast to the difference in cytosolic pH (Fig. 4a–d).

Lack of Dependence on pH of Dex-Induced Inhibition of NAG Secretion

The lowered cytosolic pH in dex-treated cells could be offset by increasing extracellular pH. However, we were unable to affect the inhibition of NAG secretion by manipulations of extracellular pH, as

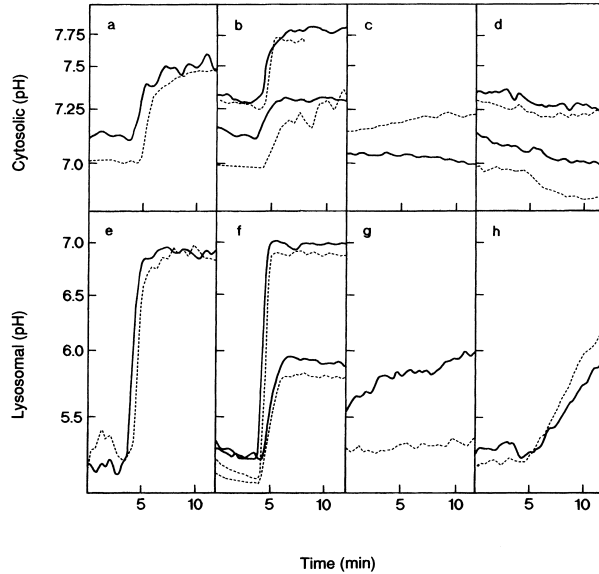

FIGURE 4

Effect of dex on changes induced in lysosomal and cytosolic pH. Cytosolic pH (a–d) was monitored as described in Materials and Methods, using cells preloaded with BCECF. Lysosomal pH (e–h) was monitored using cells preloaded with FD. Dashed traces denote cells pretreated with dex (10 nM, 20 hr). a: Cytosolic pH was measured in Na medium at pH 7.2 and monensin (5 μ M) was added after 200 sec. b: Measurement of cytosolic pH was performed in Na medium, pH 7.6 (upper two traces) or 6.7 (lower two traces). Methylamine (10 mM) was added after 200 sec. c: Cytosolic pH was monitored in cells in Na medium at pH 7.2 and the cells were pretreated with zymosan (200 μ g/ml) for 25 min before measurements. d: Measurement of cytosolic pH was performed in Na medium, pH 7.6 (upper two traces) or 6.7 (lower two traces). Bafilomycin A₁ (100 nM) was added after 200 sec. e: Lysosomal pH measurements were performed in Na medium at pH 7.2 and monensin (5 μ M) was added after 200 sec. f: Lysosomal pH was measured in Na medium. Methylamine (10 mM) was added after 200 sec. In the upper two traces extracellular pH was 7.6 and in the lower two traces 6.7. g: Monensin (5 μ M) was added after 900 sec. h: Measurements of lysosomal pH in Na medium. Bafilomycin A₁ (100 nM) was added after 200 sec. The experiments shown are representative of at least 3 independent experiments.

indicated in Figure 5. Although the magnitude of the secretory response to methylamine varied with extracellular pH (Fig. 5a), the inhibition caused by dex pretreatment did not. Nor when bafilomycin A₁ was used as stimulus was the inhibition by dex reversed by an increase in extracellular pH (not shown). Secretion of NAG in response to methylamine and PMA was also inhibited to the same degree by dex in the pH-interval tested (Fig. 5b).

Inhibition of Stimulus-Induced FD Secretion by Dex: Effect of Mannan

Macrophages can accumulate FD by fluid phase pinocytosis and the FD thus deposited in lysosomal compartments can be released together

with other lysosomal contents [2,25]. Since cellular uptake of FD is not receptor-mediated, a parallel inhibition of the release of FD and NAG would indicate that the inhibition of lysosomal secretion is not exerted at the level of receptor-mediated reuptake of lysosomal enzymes. Indeed, the inhibition of the secretory response by dex pretreatment was similar also when secretion was monitored by the release of FD (Fig. 6).

Furthermore, attempts to block mannose receptors by mannan (1 mg/ml) did not trigger NAG or FD secretion per se, nor did it significantly enhance the secretion of NAG (not shown) or FD (Fig. 6) in response to other stimuli tested. Also the secretion of NAG in response to bafilomycin A₁ or methylamine was dex-inhibitable to a similar

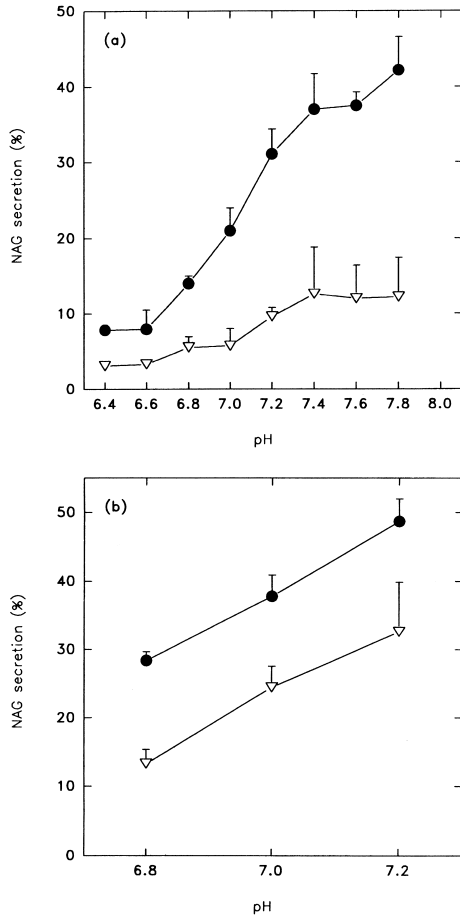

FIGURE 5 Lack of dependence on extracellular pH of dex-induced inhibition of NAG secretion. Control cells (filled circles) or cells treated with 10 nM dex for 20 hr (open triangles), were incubated for 1 hr in Na medium at the indicated pH with (a) methylamine (10 mM) or (b) methylamine (10 mM) and PMA (80 nM). Please note that secretion is expressed as percentage of total cellular NAG.

extent in both the presence and absence of mannan (not shown).

Effect of Dex on Zymosan Binding and the Generation of Inositol Phosphates

Dex was found to diminish the cellular binding of zymosan particles. Cells not treated with

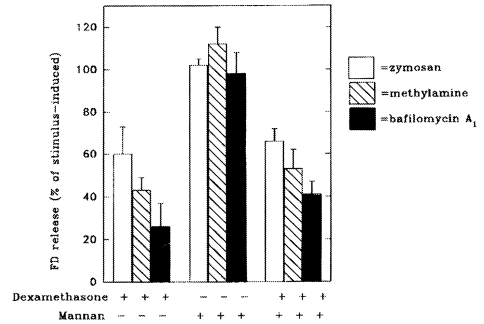

FIGURE 6 Inhibition of stimulus-induced FD secretion by dex and effect of mannan. Treatment with dex (10 nM, 20 hr) was as indicated. Mannan (1 mg/ml) was added as indicated 15 min before stimulus. Methylamine (10 mM), zymosan (200 μ g/ml), or bafilomycin A₁ (100 nM) was applied for 1 hr in Na medium, pH 7.2. The results are means \pm S.E.M. from 3–7 independent experiments. The release of FD by cells not treated with dex was set to 100% and amounted to 21 \pm 4% (zymosan), 27 \pm 3% (methylamine), and 19 \pm 3% (bafilomycin A₁) of total cellular FD.

dex had 7.7 ± 0.3 (mean \pm S.E.M., $n = 4$) particles associated per cell. Pretreatment with dex (10 nM for 20 hr) reduced the number of cell-associated zymosan particles to 3.0 ± 0.3 (mean \pm S.E.M., $n = 4$). However, the difference in binding could be offset by reducing the amount of added zymosan in control cultures from 200 to 70 μ g/ml, while retaining the higher dose in dex-treated cultures. Such a change in the dose of zymosan reduces NAG secretion by <15% in control cultures [14]. Under these conditions, with a similar average number of zymosan particles bound, the generation of inositol phosphates in cells prelabeled with [³H]inositol was still inhibited in dex-treated compared to control macrophages (Fig. 7). Thus, reduced binding does not alone account for the inhibition of phospholipase C activation.

Lack of Stimulatory Effect of Okadaic Acid on NAG Secretion

Dex was earlier shown to inhibit signaling to release of arachidonate and activation of the 85 kDa phospholipase A₂ in macrophages [26]. This inhibition could be overcome by okadaic acid, an

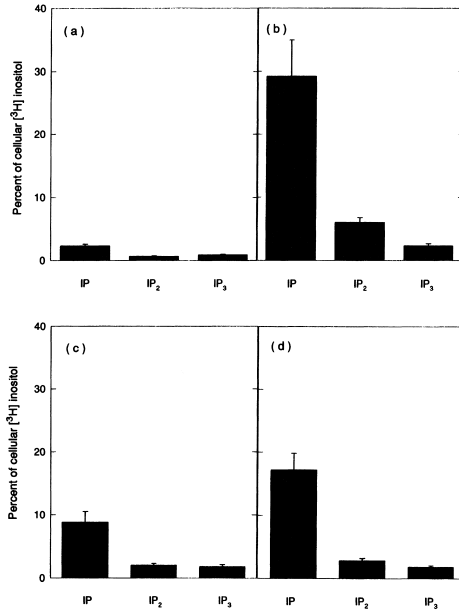

FIGURE 7 Effect of dex on inositol phosphate formation. Macrophages were labeled with [³H]inositol and processed as described in Materials and Methods. In each panel the radioactivity of inositol monophosphate (IP), inositol bisphosphate (IP₂), and inositol triphosphate (IP₃) is shown. Treatment with dex (10 nM, 20 hr) was carried out before stimulation with zymosan for 15 min where indicated. a: Non-stimulated cells. b: Zymosan-stimulated (200 µg/ml) cells. c: Dex-treated (10 nM, 20 hr) cells stimulated with zymosan (200 µg/ml). d: Zymosan-stimulated (70 µg/ml) cells.

inhibitor of Ser/Thr protein phosphatases 1 and 2A [27,28] that on its own causes activation of the 85 kDa phospholipase A₂ and release of arachidonate [29]. It was therefore investigated whether lysosomal secretion and its inhibition by dex would be similarly affected. However, okadaic acid did not trigger secretion of lysosomal contents and did not affect the secretory response induced by methylamine (not shown). Furthermore, treatment with okadaic acid (0.5 µM, 90 min) considerably decreased the secretory response to zymosan (200 µg/ml, added 30 min after okadaic acid and present for 60 min) to 33 ± 16% of that in its absence (mean ± S.E.M., n = 4). Thus, okadaic acid neither triggered secretion nor restored the dex-suppressed response to methylamine or zymosan.

DISCUSSION

Macrophages exhibit a constitutive secretory pathway by which a large number of proteins including lysozyme and inducible neutral-active proteinases are continuously released [30]. It was demonstrated early on that both basal and induced secretion of such proteinases are inhibited by nanomolar concentrations of dex, while the secretion of lysozyme is unaffected [31]. Therefore, and because the inhibition was not accompanied by any cellular accumulation of the proteinases [31], it is most likely exerted at the level of synthesis of these enzymes, rather than at the level of secretion. We now provide evidence that another process, the regulated release of lysosomal enzyme, is instead inhibited at that level, with a similar dose and time dependence.

A previous hypothesis has been that dex reduces this release by increasing the expression of mannose receptors and thereby the reuptake of lysosomal enzymes [22]. In the present study we preincubated macrophages with mannan in order to block the mannose receptor and stimuli were then added in the continued presence of mannan. However, dex inhibited stimulus-induced release of NAG also after such blocking of mannose receptors. As further support to the notion that dex might not exert its effect on lysosomal secretion at the mannose receptor level, we demonstrated that the release of FD from preloaded cells was also inhibited by dex. Since FD is not taken up via mannose receptors, dex must exert its inhibitory effect on lysosomal secretion by other mechanism(s).

Lysosomal secretion has earlier been found to be inhibited by cytosolic acidification [2] and pretreatment with dex was found to lower cytosolic pH. This effect could not account for the inhibition of lysosomal secretion, though, as the response to methylamine and monensin was inhibited, although the difference in cytosolic pH was eliminated by these agents. Furthermore, several differences were observed between the effects of dex on cytosolic pH and on lysosomal secretion. The effect of dex on cytosolic pH, but not on lysosomal secretion, was maximal after 4 hr treatment and was not further increased by higher concentrations of dex. Finally, the effect of dex on cytosolic pH, but not on lysosomal secretion, could be abrogated by an elevated extracellular pH.

Zymosan binding to mouse macrophages is

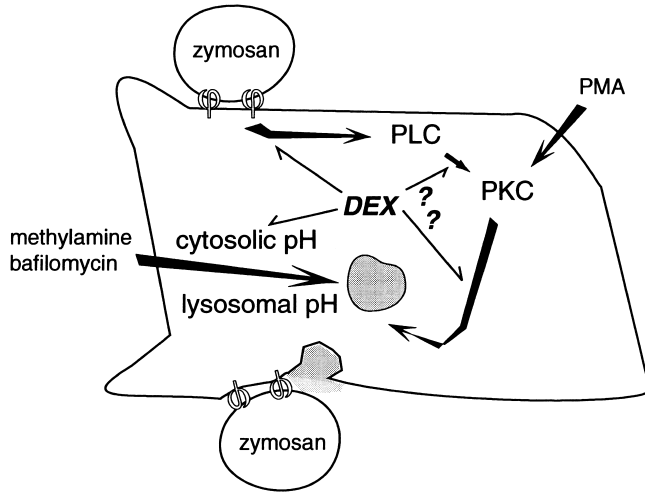

FIGURE 8

Schematic view of possible targets for dex inhibition of macrophage lysosomal secretion. Stimulation by zymosan, phorbol ester, and lysosmotropic amines/ H^+ -translocating ionophores/bafilomycin is indicated. Potential targets for dex inhibition include receptor expression, phospholipase C (PLC) activation, and step(s) distal to PKC activation and a rise in lysosomal pH.

in part mediated by β -glucan receptors [14–16]. It is therefore possible that the diminished binding noted here is due to a dex-mediated suppression of the expression of such receptors, as demonstrated earlier [16]. However, under conditions where the number of zymosan particles associated with control and dex-treated macrophages were the same, the coupling to phospholipase C was impaired by dex, as evidenced by inhibition of inositol phosphate generation. The impaired, parallel, generation of diacylglycerol would attenuate further signaling through one or more isoform of PKC. Downregulation of PKC was earlier found to reduce zymosan-induced NAG secretion to very low levels [7] and it is interesting to note that both PKC downregulation and dex pretreatment inhibited the lysosomal alkalinization normally induced by zymosan. Lysosomal alkalinization is sufficient to trigger lysosomal secretion, provided that PKC expresses basal activity and cytosolic pH is permissive [32]. However, the inhibition caused by dex does not appear to be due to a direct downregulation of phorbol-ester-binding isoforms of PKC [26]. It is of interest in this context that PMA, a direct activator of PKC, counteracts the dex-induced inhibition of secretion. We interpret this to

indicate that dex attenuates the basal, PKC-mediated signal that is necessary for secretion according to an earlier study [7]. This attenuation is partly overcome by phorbol ester stimulation. In addition, the response to zymosan is likely to be further inhibited by the attenuated phospholipase C activation. The various stimuli used and possible targets for the effects of dex are schematically illustrated in Figure 8.

The myristoylated, alanine-rich C-kinase substrates (MARCKS proteins [33] including MacMARCKS/F52 [34–36]) are potential targets downstream of PKC. MARCKS proteins interact with both actin filaments and membranes in a phosphorylation-sensitive manner [33], can cycle between the plasma membrane and lysosomes [37], and have been found to colocalize with PKC α on forming phagosomes in macrophages [38]. Their potential role in facilitation of lysosome exocytosis either by causing cytoskeletal rearrangements or by relocating between membranes directly involved in the fusion event may deserve further investigation.

ACKNOWLEDGMENTS

We thank Karolina Andersson for excellent technical assistance.

REFERENCES

1. Riches DWH, Channon JY, Leslie CC, Henson PM: Receptor-mediated signal transduction in mononuclear phagocytes. *Prog Allergy* 42:65–112, 1988.
2. Tapper H, Sundler R: Role of lysosomal and cytosolic pH in the regulation of macrophage lysosomal enzyme secretion. *Biochem J* 272:407–414, 1990.
3. Dhkuma S, Poole B: Fluorescence probe measurement of the intralysosomal pH in living cells and the perturbation of pH by various agents. *Proc Natl Acad Sci USA* 75:3327–3331, 1978.
4. Maxfield FR: Weak bases and ionophores rapidly and reversibly raise the pH of endocytic vesicles in cultured mouse fibroblasts. *J Cell Biol* 95:676–681, 1982.
5. Wileman T, Boshans RL, Schlesinger P, Stahl P: Mennensin inhibits recycling of macrophage mannose-glycoprotein receptors and ligand delivery to lysosomes. *Biochem J* 220:665–675, 1984.
6. Tapper H, Sundler R: Bafilomycin A, inhibits lysosomal, phagosomal, and plasma membrane H⁺-ATPase and induces enzyme secretion in macrophages. *J Cell Physiol* 163:137–144, 1995.
7. Tapper H, Sundler R: Protein kinase C and intracellular pH regulate zymosan-induced lysosomal enzyme secretion in macrophages. *J Leukocyte Biol* 58:485–494, 1995.
8. Manners DJ, Masson AJ, Patterson JC: The heterogeneity of glucan preparations from the walls of various yeasts. *J Gen Microbiol* 80:411–417, 1974.
9. Stahl P, Schlesinger PH, Sigardson E, Rodman JS, Lee YC: Receptor-mediated pinocytosis of mannose glycoconjugates by macrophages: Characterization and evidence for receptor recycling. *Cell* 19:207–215, 1980.
10. Warr GA: A macrophage receptor for (mannose/glucosamine)-glycoproteins of potential importance in phagocytic activity. *Biochem Biophys Res Commun* 93:737–745, 1980.
11. Giaimis J, Lombard Y, Fonteneau P, Muller CD, Levy R, Makaya-Kumba M, Lazdins J, and Poindron P: Both mannose and β -glucan receptors are involved in phagocytosis of unopsonized, heat-killed *Saccharomyces cerevisiae* by murine macrophages. *J Leukocyte Biol* 54:564–571, 1993.
12. Stahl PD, Somsel Rodman J, Miller MJ, Schlesinger PH: Evidence for receptor-binding of glycoproteins, glycoconjugates, and lysosomal glycosidases by alveolar macrophages. *Proc Natl Acad Sci USA* 75:1399–1403, 1978.
13. Szabó T, Kadish JL, Czap JK: Biochemical properties of the ligand-binding 20-kDa subunit of the β -glucan receptors on human mononuclear phagocytes. *J Biol Chem* 270:2145–2151, 1995.
14. Tapper H, Sundler R: Glucan receptor and zymosan-induced lysosomal enzyme secretion in macrophages. *Biochem J* 306:829–835, 1995.
15. Van Strijp JAG, Russell DG, Tuomanen E, Brown EJ, Wright SD: Ligand specificity of purified complement receptor type three (CD11b/CD18, $\alpha_m\beta_2$, Mac-1). *J Immunol* 151:3324–3336, 1993.
16. Goldman R: Characteristics of the β -glucan receptor of murine macrophages. *Exp Cell Res* 174:481–484, 1988.
17. Emilsson A, Sundler R: Differential activation of phosphatidylinositol deacylation and a pathway via diphosphoinositide in macrophages responding to zymosan and ionophore A23187. *J Biol Chem* 259:3111–3116, 1984.
18. Goldstein RA, Bowen DL, Fauci AS: Adrenal corticosteroids. In Gallin JI, Goldstein IM, Snyderman R (eds): "Inflammation: Basic Principles and Clinical Correlates." 2nd Ed. New York: Raven Press, 1982, pp 1061–1081.
19. Werb Z, Foley R, Munck A: Interactions of glucocorticoids with macrophages. *J Exp Med* 147:1684–1694, 1978.
20. Ringrose PS, Pair MA, McLaren M: Effects of anti-inflammatory and other compounds on the release of lysosomal enzymes from macrophages. *Biochem Pharmacol* 24:607–614, 1975.
21. Kay J, Czap JK: Enhancement of human monocyte β -glucan receptors by glucocorticoids. *Immunology* 81:96–102, 1994.
22. Shepherd VL, Konish MG, Stahl P: Dexamethasone increases expression of mannose receptors and decreases extracellular lysosomal enzyme accumulation in macrophages. *J Biol Chem* 260:160–164, 1985.
23. Gagne D, Pons M, Philibert D: RU38486: A potent antiglucocorticoid in vitro and in vivo. *J Steroid Biochem* 23:247–251, 1985.
24. Chasserot-Golaz S, Beck G: An approach to the mechanism of the potent antiglucocorticoid: 17 β -4-dimethylaminophenyl-17 α -propynyl-estra-4,9-dien-3-one. *J Steroid Biochem* 21:585–591, 1984.
25. Geisow MJ, Hart PD, Young MR: Temporal changes of lysosome and phagosome pH during phagolysosome formation in macrophages: Studies by fluorescence spectroscopy. *J Cell Biol* 89:645–652, 1981.
26. Gewert K, Sundler R: Dexamethasone down-regulates the 85 kDa phospholipase A₂ in mouse macrophages and suppresses its activation. *Biochem J* 307:499–504, 1995.
27. Bialojan C, Takai A: Inhibitory effect of a marine-sponge toxin, okadaic acid, on protein phosphatases. *Biochem J* 256:283–290, 1988.

28. Cohen P, Cohen PTW: Protein phosphatases come of age. *J Biol Chem* 264:21435–21438, 1989.
29. Svensson U, Houweling M, Holst E, Sundler R: Phosphorylation and activation of the arachidonate-mobilizing phospholipase A₂ in macrophages in response to bacteria. *Eur J Biochem* 213:81–86, 1993.
30. Davies P, Bonney RJ: The secretion of hydrolytic enzymes by mononuclear phagocytes. In Weissman G (ed): "The Cell Biology of Inflammation." Amsterdam: Elsevier/North-Holland Biomedical Press, 1980, pp 497–542.
31. Werb Z: Biochemical actions of glucocorticosteroids on macrophages in culture. Specific inhibition of elastase, collagenase and plasminogen activator secretion and effects on other metabolic functions. *J Exp Med* 147:1695–1712, 1978.
32. Tapper H: The secretion of preformed granules by macrophages and neutrophils. *J Leukocyte Biol* 59:613–622, 1996.
33. Aderem A: The MARCKS brothers: A family of protein kinase C substrates. *Cell* 71:713–716, 1992.
34. Umekage T, Kato K: A mouse brain cDNA encodes a novel protein with the protein kinase C phosphorylation site domain common to MARCKS. *FEBS* 286:147–151, 1991.
35. Li J, Aderem A: MacMARCKS, a novel member of the MARCKS family of protein kinase C substrates. *Cell* 70:791–801, 1992.
36. Blackshear PJ, Verghese GM, Johnson JD, Haupt DM, Stumpo DJ: Characteristics of the F52 protein, a MARCKS homologue. *J Biol Chem* 267:13540–13546, 1992.
37. Allen L-AH, Aderem A: Protein kinase C regulates MARCKS cycling between the plasma membrane and lysosomes in fibroblasts. *EMBO J* 14:1109–1121, 1995.
38. Allen L-AH, Aderem A: A role for MARCKS, the α isozyme of protein kinase C and myosin I in zymosan phagocytosis by macrophages. *J Exp Med* 182:829–840, 1995.



Signaling to Localized Degranulation in Neutrophils Adherent to Immune Complexes

Claes Naucler, Sergio Grinstein[‡], Roger Sundler and Hans Tapper

Department of Cell and Molecular Biology, Lund University, BMC B11, Sölvegatan 19, S-221 84 Lund, Sweden; [‡]Division of Cell Biology, Research Institute, The Hospital for Sick Children, Toronto, ON, Canada.
Telephone: +46-46-2224488 Fax: +46-46-157756 E-mail: hans.tapper@medkem.lu.se

Abstract: The present study demonstrates that the secretion of azurophilic granules occurring during Fc-receptor-mediated attachment and spreading of neutrophils is highly localized to the adhering region of the cell. In contrast, the secretion of specific granules occurs in a non-polarized fashion. This implies that unique signals are involved in the regulation of azurophilic degranulation. Assembly of actin filaments, as visualized by staining with rhodamine phalloidin, neither hindered nor facilitated degranulation. Further, the azurophilic secretory response remained localized in the presence of cytochalasin B. Release of azurophilic granule content was inhibited by genistein and erbstatin, inhibitors of tyrosine kinases, and by GF109203X, a protein kinase C inhibitor. We could also demonstrate a relative enrichment of syk tyrosine kinase and the protein kinase C (PKC) isoforms α and $\beta 1$ in adherent plasma membranes.

Keywords: secretion, exocytosis, neutrophil, inflammation, cellular activation

INTRODUCTION

Neutrophils are important cells in our first line of defense against invading microorganisms. These cells recognize, phagocytose and kill bacteria by producing reactive oxygen species and by releasing lytic enzymes through degranulation. These responses can be triggered in neutrophils interacting with antigen-antibody (immune) complexes deposited in the circulation or in tissues and are potentially contributing to host tissue damage. Neutrophils are thus involved in diseases like vasculitis and nephritis. Neutrophils interact with immune complexes through the low affinity IgG receptors Fc γ RIIA and Fc γ RIIB [1] and this interaction can trigger a degranulation response [2]. Engagement of these receptors leads to phosphorylation of immunoreceptor tyrosine-based activation motifs (ITAMs) by src-related protein tyrosine kinases such as Hck and Lyn [3, 4]. Phosphorylation of two such YXXL motifs, typically located 10 to 12 amino acids apart in the intra-cytoplasmic tails, mediates association of proteins containing SH2-domains such as the protein tyrosine kinase syk. Activation of this kinase, which in turn contains tyrosines that are phosphorylated upon binding to ITAMs, leads to propagation of the signaling cascade to several down-stream pathways

eventually leading to production of diacylglycerol [5] and initiation of Ca²⁺-transients [6] which in turn cause the activation of PKC. Neutrophils harbour at least four distinct types of granules that differ in regards to content, membrane proteins and their propensity to be secreted [7]. The secretion of neutrophil granules can be triggered by an increase in intracellular Ca²⁺, but additional signals are involved in the regulation of azurophilic degranulation [8-10] and a role for G-proteins, tyrosine kinases and PKC has been proposed [11, 12]. Neutrophil functions, such as phagocytosis and migration, are dependent on remodeling (and polymerization) of actin filaments [13]. Fc-receptor-triggered reorganization of actin filaments could possibly determine localization of a secretory response through their association with various signaling molecules. In this study, the spatial distribution of actin filaments during neutrophil adhesion was analyzed to evaluate a potential role in determining the localization of azurophilic degranulation.

A highly localized azurophilic degranulation targeted towards forming phagosomes has recently been shown to occur in neutrophils phagocytosing IgG-opsonized zymosan [14]. It is not fully understood what determines the localization of this secretory response. The target membrane might be rendered "fusogenic" due to an enrichment of proteins that are part of a fusion complex or, alternatively, a spatially restricted production of second messengers could act to direct vesicle movement towards the target site where degranulation occurs. We devised a system to study the localization of tentative signaling molecules involved in the regulation of degranulation triggered by adhesion to surfaces coated with immune complexes.

MATERIALS AND METHODS

Chemicals.

Anti-CD63 and anti-CD66b were kind gifts of Dr. A. J. Verhoeven (Red Cross Blood Transfusion Centre, Central Laboratory of the Netherlands). Rabbit polyclonal antibodies against PKC $\beta 1$ and syk, and monoclonal anti-phosphotyrosine antibody (PY99) used for Western blot, were purchased from SantaCruz Biotech (SantaCruz, CA). Monoclonal antibodies against PKC α , δ and ζ were purchased from Transduction Laboratories (Lexington, KY). Anti-phosphotyrosine monoclonal antibody (G410) was bought from Upstate Biotechnology (Lake Placid, NY). Donkey serum and secondary antibodies

were purchased from Jackson Immuno Research (West Grove, PA). GF109203X was purchased from Calbiochem (La Jolla, CA). FM1-43, ProLong and rhodamine phalloidin were purchased from Molecular Probes (Eugene, OR). Paraformaldehyde was from J.B.EM Services Inc (Dorval, Quebec). Dextran T500, Ficoll, Sepharose 4B and cyanogen bromide-preactivated Sepharose 4B were purchased from Pharmacia Biotech (Uppsala, Sweden). All other chemicals including RPMI-1640 and 4-methyl umbelliferyl N-acetyl- β -D-glucosaminide were purchased from Sigma Chemical Co. (St. Louis, MO). Human IgG was a kind gift from the Department of Immunology at the Hospital for Sick Children, Toronto, Canada.

Buffers.

All experiments were performed in medium containing 127 mM NaCl, 5.6 mM glucose, 5.4 mM KCl, 1.2 mM KH_2PO_4 , 0.8 mM MgSO_4 , 1.8 mM CaCl_2 and 10 mM HEPES. The pH was adjusted to 7.4 using NaOH and the medium was filtered before use. Coupling buffer contained 0.5 M NaCl and 50 mM NaHCO_3 and pH was adjusted to 8.0 using NaOH. Acetate buffer contained 0.5 M NaCl and 5 mM Na acetate and pH was adjusted to 4.0 using acetic acid. Borate buffer contained 0.5 M NaCl and 0.56 mM Na borate and pH was adjusted to 8.0 by addition of boric acid.

Preparation of neutrophils.

To 60 ml fresh blood from healthy donors was added 9 ml 4.5% dextran. After 45 min, the top layer was centrifuged at 1500 rpm for 5 min. The pellet was re-suspended in PBS and layered on top of 4 ml of Ficoll. After centrifugation for 20 min at 3000 rpm, the pellet was resuspended in 0.5 ml HEPES-buffered RPMI. Any remaining erythrocytes were lysed by incubation with NH_4Cl at 37 °C for 10 min. Neutrophils were then washed twice in RPMI and counted in a Coulter counter. Neutrophils were kept on rotation at a concentration of 10^7 neutrophils/ml RPMI until experiments were performed.

Preparation of heat-aggregated IgG (HAIGG) and coating of beads.

HAIGG was prepared by heating human IgG for 1 hr at 63°C. CnBr-activated Sepharose beads were washed 3 times in 1 mM HCl and 3 times in coupling-buffer (pH 8.0). 10 mg HAIGG was diluted in coupling buffer pH 8.0 to a final volume of 8 ml. Diluted HAIGG was mixed with 800 mg of the washed Sepharose and coupling was performed at room temperature under constant rotation for 2 h. The coated Sepharose was washed 3 times in coupling buffer and rotated for 2 h at room temperature in 10 ml of coupling-buffer containing 1 M ethanolamine to block remaining non-coupled sites on the Sepharose beads. A two-step washing procedure was then performed with acetate-buffer pH 4.0 followed by borate-buffer pH 8.0. This was repeated 3 times. The coated Sepharose was rotated in borate-buffer overnight, washed and re-suspended in

borate-buffer to a final concentration of 100 mg Sepharose per ml borate-buffer. The Sepharose was stored at 4°C not more than one week before use. The coated Sepharose was always washed 3 times in experimental medium before use.

Immunofluorescence and confocal microscopy.

Cells adherent to Sepharose-beads were fixed in 1.6% paraformaldehyde for 15 min on ice followed by 45 min at room temperature. When imaging phosphorylated tyrosine and actin filaments, cells were permeabilized using ice-cold permeabilization buffer containing 0.1% Triton X-100, 100 mM PIPES (pH 6.8), 5 mM EGTA, 100 mM KOH and 2 mM MgCl_2 for 5 min. When studying tyrosine phosphorylation or degranulation of specific or azurophilic granules, cells were washed 3 times in PBS and then blocked with 5% donkey serum for 1 h. After 2 washes in PBS, cells were incubated for 4 h with the primary antibody in PBS containing 1% BSA. Cells were then washed 3 times and incubated for 1 h with a secondary Cy3-conjugated antibody in PBS containing 1% BSA. After final washing steps, all buffer was replaced by ProLong mounting medium and the stained preparations were mounted on coverslips. Confocal microscopy was performed using a Leica TCS confocal microscope.

Quantification of localized versus non-localized degranulation.

Microscopy slides were prepared as described above where exocytosis of azurophilic and specific granules was detected by antibodies against CD63 and CD66b, respectively, in non-permeabilized cells. Light microscopy (DIC) was used for selection of intact cells that were firmly attached to beads. Thereafter, the distribution of the markers for azurophilic and specific degranulation were further analyzed in these adherent cells. Degranulation was scored as localized to the adherent aspect of the cell when approx. >75% of the staining was in the adherent membrane. Otherwise, the degranulation was scored as occurring in a non-localized fashion. Similar results were obtained by 3 different observers.

Enzyme assay for N-acetyl- β -D-glucosaminidase (NAG).

In these experiments, Na-medium was supplemented with 10 μM aprotinin, 10 μM leupeptin and 1 μM pepstatin A and experiments were performed in culture dishes containing 24 wells. 40 mg HAIGG-Sepharose in 0.5 ml Na-medium was sedimented in a culture-dish well on ice. 2×10^6 neutrophils in 0.5 ml Na-medium were added and the cells were allowed to sediment for 10 min on ice. The culture dish was then placed in a 37°C water-bath for various times to allow cell adhesion. Adhesion was terminated by placing the dish on ice. Cells and beads were re-suspended and placed in an eppendorf tube, spun down and the medium collected. The pellet was then re-suspended in Na-medium containing 0.1% Triton X-100. This solution was also used to wash off any

remaining cells from the culture dish. To the medium-sample was added Triton X-100 to a final concentration of 0.1% and samples were kept on ice until enzyme-measurements were performed.

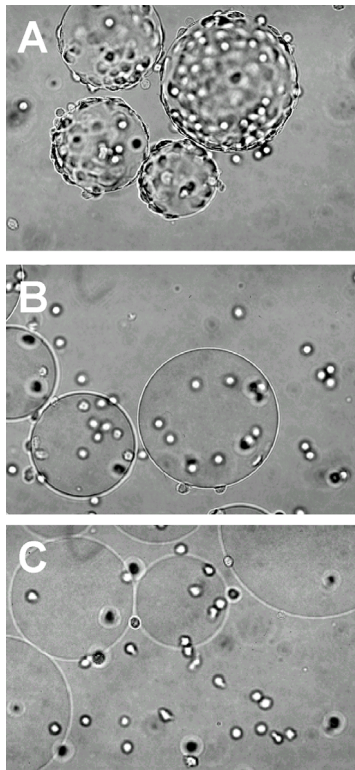

Fig. 1. Adhesion of neutrophils to immune complex-coated Sepharose beads. Neutrophils and beads were incubated for 60 sec at 37°C in Na-medium. In (A) and (B), beads were coated with HA1gG. In (B), the medium contained soluble IgG (10µg/ml). In (C), non-coated beads were used. Images were captured on Kodak slide film (ASA 400) using a Nikon F-601M camera mounted on a Nikon diaphot-TMD inverted microscope (40x objective, phase contrast). Slides were scanned in a Nikon slide-scanner.

The substrate-buffer contained 0.1 mg/ml 4-methyl umbelliferyl N-acetyl-β-D-glucosaminide and 0.3 M citric acid, pH 4.5. 1.6 ml substrate-buffer was heated to 37°C and mixed with 0.4 ml sample and analysis was performed at 37°C. Where pharmacological inhibitors were used, the cells were pre-incubated with the inhibitor at 37°C for 30 min (erbstatin) or 10 min (GF109203X or genistein). Enzyme release (%) was calculated as enzyme activity in the medium divided by the total activity in the medium and cell lysate.

Separation of adherent plasma membrane by sonication.

50x10⁶ neutrophils were suspended in 150 µl experimental medium and mixed with 60 mg

HA1gG-Sepharose on ice. After incubating cells and beads for 1 min at 37°C to allow adhesion, cross-linking was performed at 4°C for 15 min and at room temperature for 45 min in 1 ml PBS containing 2 mM 3,3'-dithio-bis(propionic acid H-hydroxysuccinimide ester) and 10% DMSO. Non-adherent cells were washed away by centrifuging 3 times at 100 rpm for 10 min in PBS containing 5 mM EDTA, 1 mM PMSF, 10 µg/ml aprotinin, 10 µg/ml leupeptin and 1 µg/ml pepstatin A. Beads were then re-suspended in 1 ml ice-cold PBS and repeatedly sonicated for 10 sec in a Fisher sonic dismembrator model 300 until all adherent cells were broken and only plasma membrane patches remained on the beads (verified by repeated inspection of FM1-43-labeled samples in a fluorescence microscope). The Sepharose was then pelleted and the supernatant containing the ripped-off cells was collected. This was repeated 3 times by washing the Sepharose in 20 times diluted PBS containing 5 mM EDTA, 1 mM PMSF, 10 µg/ml aprotinin, 10 µg/ml leupeptin and 1 µg/ml pepstatin A. The ripped-off cells were further sonicated 3 times for 10 sec in a Heat Systems Ultrasonic processor XL sonicator, nuclei and intact cells spun down for 5 min at 3000 rpm and membranes retrieved by ultracentrifugation for 1 hr at 200000 g. The pellet was re-suspended in 200 µl Laemlli sample buffer containing 50 mM DTT, boiled for 15 min and DNA was spun down. Supernatants were passed 10 times through a thin-gauged syringe. To samples containing beads with adherent plasma membranes were added 200 µl boiling 2x concentrated Laemlli sample buffer containing 100 mM DTT. These were then boiled for 15 min and passed through a syringe with a layer of glass fiber wool to remove the Sepharose. The final volume was approximately 400 µl due to fluid from the beads. Samples were separated on 7.5% gels, transferred onto PVDF-membranes and probed with antibodies. Protein-bands were scanned and densities analyzed using NIH imaging software. In order to estimate the relative enrichment of signaling molecules in fractions containing adherent membranes we used two different approaches to determine the percent of total plasma membranes present in the adherent patch. In the first approach, cell-surface proteins were biotinylated prior to adhesion. Neutrophils were spun down and re-suspended in 2 ml ice-cold PBS (pH 7.8) containing 200 µg/ml biotin-NHS-LC. The cells were then washed in two steps. In each step, the cells were incubated for 10 min on ice in PBS containing 1% BSA to block residual biotin. Such treatment has been shown not to activate neutrophils [15, 16]. Experiments were then performed as described and membrane pools collected and run on SDS-PAGE. Biotin was labeled using avidin-HRP at the dilution 1:5000 for 1 h. A distinct band at approximately 150 kDa, visualized on Western blot using Avidin-HRP, was present in both adherent and ripped-off samples. Protein densities were measured as described above and the presence of biotinylated 150 kDa protein in adherent samples as percentage of total contents (adherent plus ripped-off samples) was calculated. 24.9±2.9% (SEM, n=6) of the total

amount of 150 kDa protein was present in the adherent samples. In the second approach, neutrophils were pretreated with tritiated 4,4'-diisothiocyanatostilbene-2,2'-disulphonic acid (DIDS) before adhesion. Aliquots from adherent plasma membranes and non-adherent plasma membranes were taken before running SDS-PAGE and quantified in a scintillation counter. $28.1 \pm 2.4\%$ (SEM, $n=5$) of the plasma membrane was adhered to beads as estimated by amount of bead-associated DIDS-labeled proteins. Values from the latter approach were used to normalize protein content in adherent and non-adherent pools for plasma membrane content.

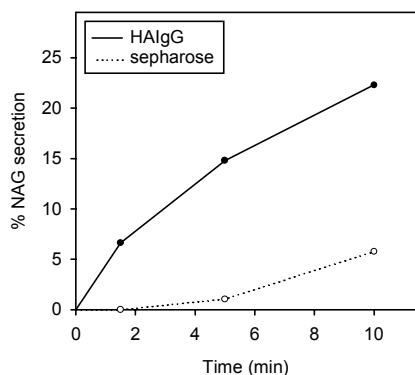

Fig. 2. Release of azurophilic granule content during neutrophil adhesion to immune complexes. Neutrophils were incubated with HAlG-Sepharose (filled circles) or non-coated Sepharose (open circles) in Na-medium at 37°C. NAG enzyme activity was measured in a Hitachi F-4000 fluorescence spectrophotometer, with wavelengths for emission=365 nm and excitation=460 nm. This experiment was repeated three times and one representative experiment is shown.

RESULTS

Adhesion of neutrophils to HAlG-coated Sepharose.

We devised an experimental system using Sepharose beads covalently coupled with heat-aggregated human immunoglobulin (HAlG) in order to get an understanding of the signaling pathways that are involved in triggering and directing degranulation in human neutrophils. The use of Sepharose conveyed several advantages. Neutrophils adherent to porous Sepharose could not form sealed-off spaces between the plasma membrane and the substratum for adhesion. Such sealed-off spaces have been characterized in osteoclasts but have also been reported for adherent neutrophils [17]. Thus, the use of Sepharose as a substratum allowed secreted substances to escape a putative sealed-off space and it also allowed access to antibody for immunofluorescence studies of the adherent plasma membrane without permeabilization of the cells. Also, high-resolution confocal images of

adhering neutrophils in profile could be obtained without using 3D-reconstruction of cells studied from a verticle angle.

Figure 1A shows neutrophils adherent to HAlG-Sepharose after 60 sec incubation at 37°C. Neutrophils did not adhere non-specifically to non-coated Sepharose (Figure 1C). Further, adhesion to HAlG-coated Sepharose was almost totally eliminated in the presence of soluble IgG (10 µg/ml) (Figure 1B).

Degranulation during adhesion.

Adhesion to HAlG-coated Sepharose triggered the release of NAG, an azurophilic granule content-marker [7]. This release was clearly measurable within 1.5 min of adhesion and increased during the first 5 min of adhesion (Figure 2). Neutrophils layered for 5 min on non-coated Sepharose did not release azurophilic granule content. The minor release observed between 5 and 10 min during stimulation with non-coated Sepharose could be due to interaction with tissue culture well-plastic (Figure 2). Adhesion of cells to HAlG-Sepharose could be seen already within 15 sec of presentation to neutrophils (Figure 3A). After an additional 15 sec, neutrophils started to spread on the surface (Figure 3C) and after 60 sec most cells showed a flat appearance (Figure 3E and G). Degranulation was also monitored using the azurophilic granule membrane-marker, CD63 [18]. No azurophilic degranulation could be detected within 15 sec of adhesion (Figure 3B). Azurophilic degranulation was initiated within 30 sec of adhesion and was then confined to the center of the adherent plasma membrane (Figure 3D). As the cells spread, the target was enlarged in a circular fashion towards the periphery of the adherent plasma membrane. The near maximal staining seen after 60 sec of adhesion was mainly located at the adherent surface of the cells. Also, the degranulation of specific granules was studied through the appearance of CD66b, a specific granule membrane-marker [19], on the cell surface. Degranulation of specific granules, which was also triggered within 60 sec of adhesion, showed a less localized staining-pattern than CD63 and was not restricted to the adherent membrane (Figure 3H). Quantitative data on percentage of adherent cells displaying azurophilic and specific degranulation localized to the site of adhesion is shown in Table 1.

Table 1. Localization of degranulation

Granule type	localized	non-localized
Azurophilic (CD63)	92.3± 0.9	7.7± 0.7
Specific (CD66b)	3.3± 0.3	96.7± 0.3

Neutrophils were adhered to HAlG-sepharose for 1 min, labeled with antibodies and prepared for microscopy as in Figure 3. Polarization of the secretory response was determined by ocular inspection of 100 adherent cells in each experiment. Data represent % of cells and are means±SEM for 3 separate experiments.

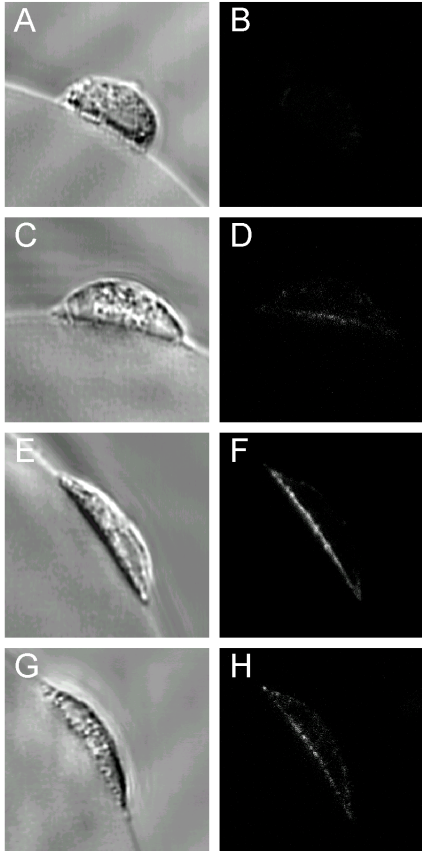

Fig. 3. Time-course and spatial distribution of azurophilic and specific granule exocytosis during adhesion to immune complexes. Confocal immunofluorescence cross-sections ($1\mu\text{m}$) show CD63-staining of non-permeabilized neutrophils (B, D and F). The corresponding DIC-images are shown in (A, C and E). (H) shows CD66b-staining of non-permeabilized cells and (G) shows the corresponding DIC-image. Neutrophils were allowed to adhere to HAIGG-Separose for 15 sec (A-B), 30 sec (C-D) or 60 sec (E-H) at 37°C in Na-medium.

Actin filaments and polarized secretion.

In phagocytes, actin is assembled in the vicinity of a forming phagosome and phagocytosis is inhibited in the presence of cytochalasin B [20]. Localization of actin filaments and degranulation could be governed by common signaling pathways or localization of actin filaments might direct degranulation through their association with signaling molecules. Here we found an opportunity to assess the relationship between localization of actin filaments and degranulation in adhering neutrophils. Actin filaments, as visualized by staining with rhodamine phalloidin, were localized at the adherent surface of neutrophils after 60 sec of adhesion (Figure 4D) and images captured from

a perpendicular angle from the adherent surface revealed an accumulation of actin filaments at the periphery of the cells, in spreading lamellopodiae (Figure 4D, inset). Actin filaments were scarce at the center of the adherent surface, where the bulk of azurophilic degranulation was seen (Figure. 4B cf D).

Neutrophils adhered to HAIGG-beads also in the presence of cytochalasin B but did not spread (Figure 5A). This treatment greatly diminished assembly of actin at the periphery of the adherent surface and residual staining was probably due to re-localization of preformed actin filaments. The inhibition of spreading and actin filament assembly by cytochalasin B did not interfere with the localization of azurophilic degranulation (Figure 5B).

Involvement of tyrosine kinases and PKC in regulation of neutrophil azurophilic degranulation.

In addition to initiating the Fc-receptor-dependent signaling through phosphorylation of ITAMs upon cross-linking, activated tyrosine kinases also convey further propagation of signaling from activated Fc-receptors [21]. Phosphorylation of tyrosine was detected after 60 sec adhesion to HAIGG-sepharose as assessed by immunofluorescence using a monoclonal antibody. Phosphorylated tyrosine was accumulated at the adherent plasma membrane (Figure 4F) and was always highly co-localized with the up-regulation of CD63 (Figure 4B). The induction of tyrosine phosphorylations was confirmed by Western blot analysis. Neutrophils incubated with HAIGG-sepharose on ice showed a similar tyrosine phosphorylation pattern as neutrophils incubated without beads. However, cells adhered for 5 min at 37°C to HAIGG-sepharose exhibited increased tyrosine phosphorylation in several protein bands (Figure 4G). In the presence of cytochalasin B, the tyrosine phosphorylation appeared slightly diminished but was still localized to the site of adhesion (Figure 5F). We therefore postulated that tyrosine phosphorylation events might initiate degranulation through activation of downstream signaling-cascades. We next studied the effect of two different inhibitors of tyrosine kinases on the adhesion-induced release of NAG. Both genistein and erbstatin, inhibitors of tyrosine kinases [22], efficiently inhibited the release of NAG (Table 2). The effect of genistein on phosphorylation of proteins on tyrosine was confirmed by Western blot analysis (Figure 4G). Tyrosine phosphorylations in cells adhered to HAIGG-sepharose for 5 min at 37°C were effectively inhibited already at $50\ \mu\text{M}$ genistein and this correlated with the inhibition of NAG secretion by genistein.

A role for PKC in regulation of degranulation has been shown in both macrophages and neutrophils [11, 23]. Pretreatment of neutrophils with GF109203X, a specific inhibitor of PKC, decreased the release of NAG during adhesion and an almost total inhibition was observed at $2.5\ \mu\text{M}$ GF109203X (Table 2).

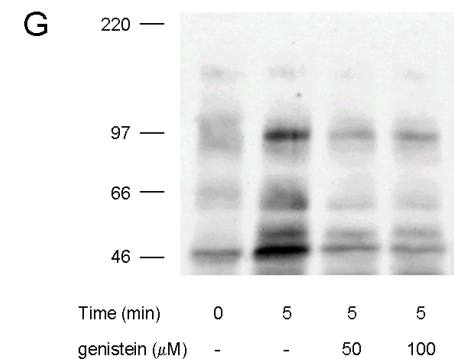
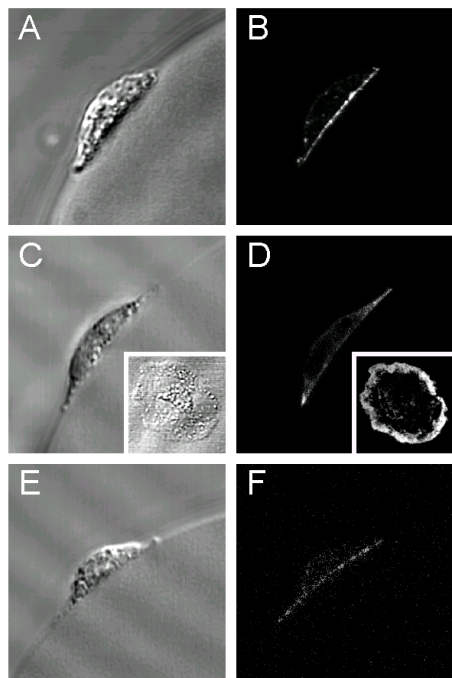

Fig. 4. Organization of actin filaments and phosphorylation of tyrosine during neutrophil degranulation. Neutrophils were adhered to HAlG-Sepharose for 60 sec at 37°C in Na-medium. (B) shows CD63-staining of non-permeabilized cells, (D) shows rhodamine phalloidin-staining of permeabilized cells and (F) shows phosphorylated tyrosine-staining of permeabilized cells. The corresponding DIC-images are shown in (A, C and E). (G) shows a Western blot of neutrophils adhered to HAlG-Sepharose for 0 or 5 min at 37°C in Na-medium. Tyrosine-phosphorylated proteins were detected using a monoclonal antibody (PY99). Cells in the two rightmost lanes were pre-treated with genistein for 10 min at 37°C. Neutrophils were presented to beads as in experiments where release of NAG was measured.

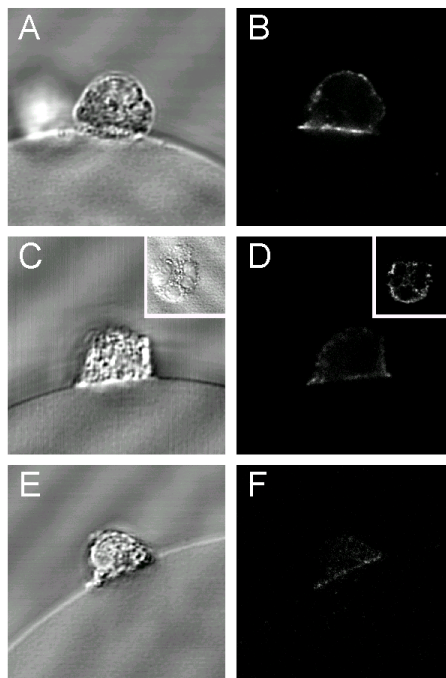

Fig. 5. Effect of cytochalasin B on localization of azurophilic degranulation and phosphorylation of tyrosine. Neutrophils were pre-treated with 10 μ M cytochalasin B for 20 min and then adhered to HAlG-Sepharose for 60 sec at 37°C in Na-medium. (B) shows CD63-staining of non-permeabilized cells, (D) shows rhodamine phalloidin-staining of permeabilized cells and (F) shows phosphorylated tyrosine-staining of permeabilized cells. The corresponding DIC-images are shown in (A, C and E).

Table 2. Effect of inhibitors on NAG secretion

Inhibitor	concentration (μ M)	percent inhibition
erbstatin	2.5	76.0 \pm 12.0
	5.0	93.7 \pm 6.3
genistein	50.0	71.0 \pm 3.2
	100.0	77.4 \pm 11.5
GF109203X	2.5	95.7 \pm 4.3
	5.0	99.0 \pm 1.0

Neutrophils were treated with genistein and GF109203 for 10 min or erbstatin for 30 min at 37°C and were then adhered to HAlG-coated sepharose beads for an additional 5 min. Data are presented as means of 3 separate experiments \pm SEM.

Localized enrichment of syk and isoforms of PKC during neutrophil degranulation.

In this study, we used sonication in order to separate the adherent plasma membranes from the rest of the cells. This allowed quantification of the relative enrichment of proteins associated with the adherent plasma membrane as compared to

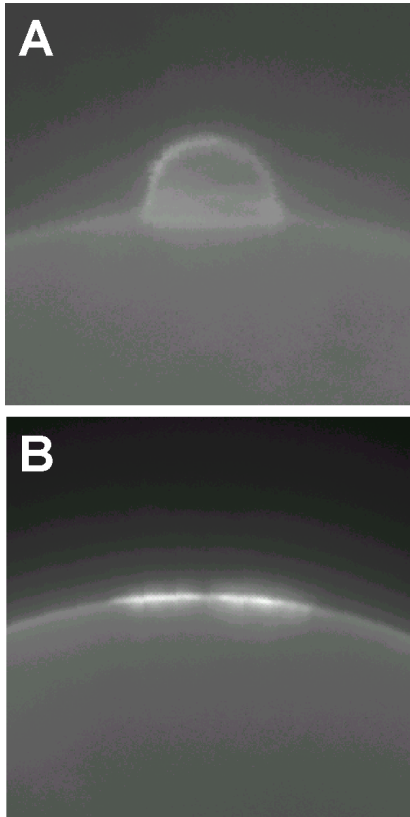

Fig. 6. Removal of non-adherent membrane by sonication. Neutrophils were adhered to HAlgG-Sepharose for 60 sec in Na-medium at 37°C followed by cross-linkage and sonication as described in methods. Cells were stained with 5 μ M FM1-43. (A) shows an intact cell and (B) shows a cell after sonication. Images were captured using a Leica DM IRB fluorescence microscope equipped with a 100x oil-objective and a Princeton cooled CCD camera.

the rest of the plasma membrane. A firm attachment of the adherent plasma membranes to the HAlgG-Sepharose beads was assured by treatment of adherent cells with a protein cross-linker. Figure 6A shows an adherent neutrophil before sonication. Non-adherent parts of the cells were ripped-off by stepwise sonication with intervening controls of the results in a fluorescence microscope using the lipophilic dye FM1-43. This procedure was repeated until only adherent patches of membrane remained on the beads (Figure 6B). The purity of isolated adherent membranes was investigated by electron microscopy and the sonicated cross-linked membranes were found to be devoid of granules, ER, nuclei or other cellular debris (Figure 7B). A higher magnification of the adherent plasma membrane lipid bi-layer is shown as an inset in Figure 7B. Samples of adherent membranes and ripped-off non-adherent membranes were run on SDS-PAGE/Western blots in order to determine the distribution of proteins between the two pools of membrane. Relative amount of plasma membranes in the pools was determined using two separate approaches (see methods). When assessed by the distribution of a biotinylated membrane protein of approximately 150 kDa, $24.9 \pm 2.9\%$ (SEM, n=6) of the plasma membrane was found to be attached to the HAlgG-sepharose. The 150 kDa protein was not identified and its relevance as a marker for the plasma membrane was not evaluated but similar results were obtained using a different protocol. Quantification of plasma membrane proteins pre-labeled with tritiated DIDS showed that $28.1 \pm 2.4\%$ (SEM, n=5) of the plasma membrane was attached to the beads. The latter method was used for calculation of the percentage of plasma membrane that was in contact with HAlgG-sepharose. When separating proteins on Western blots, the IgG heavy chains from the HAlgG-coated Sepharose appeared as a dense band at approximately 50 kDa. This leakage of aggregated IgG which was probably caused by the sonication procedure limited the analysis of the enrichment of signaling molecules to proteins that did not migrate between 40 and 60 kDa on SDS-PAGE.

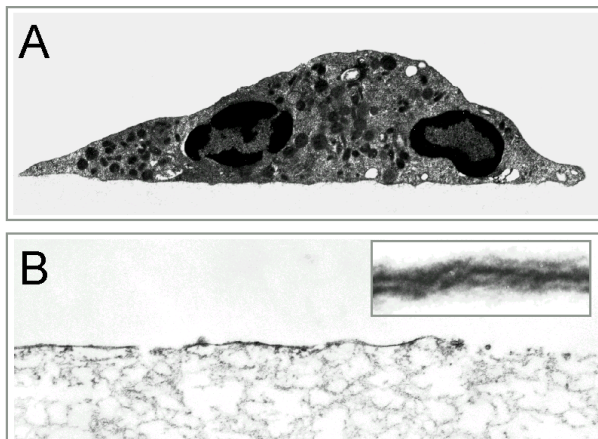

Fig. 7. Purity of sonicated adherent plasma membranes. Neutrophils were adhered to HAlgG-sepharose for 60 sec in Na-medium at 37°C. Electron microscopy images of an intact neutrophil adherent to HAlgG-coated Sepharose (A, magnification 4000x) and adherent plasma membrane after sonication (B, magnification 12000x). Inset in (B) shows a higher magnification of the plasma membrane lipid bi-layer. Cells were fixed for 12 h with 4% glutaraldehyde at 4°C and samples for EM were 90 nm thick.

We could study the localization of syk (72 kDa) during adhesion of neutrophils to HA1gG-Sepharose. Syk is a non-receptor tyrosine kinase present in haematopoietic cells [21]. Phosphorylation and activation of syk by Fc-receptor activation has been shown to occur in several cell-types [24, 25]. Syk cannot itself phosphorylate ITAM in vitro [26] but contains two SH2-domains that can interact with phosphorylated ITAMs and syk has been shown to associate with activated Fc-receptors [27]. Syk was found in the adherent plasma membrane after 60 sec of adhesion (Figure 8). The density of these bands was measured and normalized for amount of attached plasma membrane and a relative enrichment of 3.10 ± 0.82 (SEM, $n=6$) was found (Figure 9). Thus, syk was enriched at the site of adhesion when degranulation was occurring. Since azurophilic degranulation was sensitive to inhibition of PKC we analyzed the distribution of some isoforms expressed in neutrophils (Figure 8). Both PKC α and β_1 were enriched in the adherent plasma membrane after 60 sec of adhesion (Figure 9). The β_1 isoform was slightly more enriched in the adherent plasma membrane (2.38 ± 0.63 , SEM, $n=11$), than the α isoform (1.98 ± 0.46 , SEM, $n=8$). PKC δ on the other hand, was evenly distributed after 60 sec of adhesion, with a relative enrichment in the adherent plasma membrane of 1.07 ± 0.12 (SEM, $n=7$). Also the atypical isoform, ζ , was found not be enriched in the adherent plasma membrane (Figure 9).

DISCUSSION

A highly localized azurophilic degranulation has recently been demonstrated to occur in neutrophils during Fc-receptor-mediated phagocytosis [14]. In this study, also degranulation triggered by adhesion to immune complexes was found to be localized. It is not known, however, which mechanisms are involved in localization of degranulation. Fc-receptor stimulation triggers rapid activation of several signaling cascades including protein and lipid kinases [21] and degranulation was detected already within 30 sec of adhesion. Because of the role for actin in phagocytosis, cell adhesion, and spreading, we investigated the relation between the actin filament network and localization of degranulation. Actin polymerization might allow a localized assembly of signaling molecules that are involved in the polarization of neutrophil degranulation. In some systems, degranulation is facilitated by the disassembly of actin filaments [28-30]. However, no evidence for an involvement of actin in the targeting of degranulation was found. Actin filaments were located at the periphery of the adhering surface in neutrophils while degranulation was more evenly distributed over the adherent surface. Furthermore, a localized azurophilic degranulation was observed in the presence of cytochalasin B, although polymerization of actin at the site of adhesion was diminished and cells were prevented from spreading. This is in accordance with a study

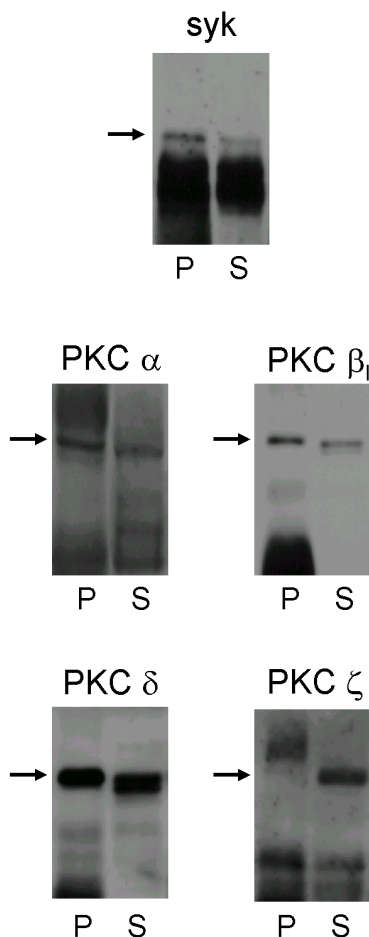

Fig. 8. Syk and PKC in adherent and non-adherent plasma membrane. Western blots of adherent (P) and non-adherent (S) plasma membrane fractions from neutrophils adherent to HA1gG-Sepharose in Na-medium for 60 sec at 37°C. Syk, PKC α , β_1 , δ and ζ were detected using primary antibodies and secondary HRP-labeled antibodies.

showing that localized degranulation is initiated before phagosome sealing and is not inhibited by cytochalasin B [14].

For degranulation to occur, granules must translocate towards the target and then dock and fuse with the plasma membrane. In a model where a non-specific centrifugal movement of granules is triggered, localization of degranulation would depend on local accumulation of fusion proteins. In an alternative model, where the whole plasma membrane is accessible for docking and fusion, localization of degranulation would depend on guided movement of vesicles. We refined a technique to quantify the accumulation of signaling molecules in the adherent plasma

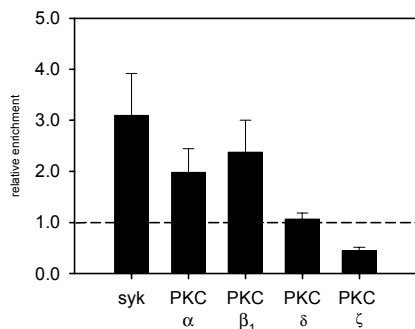

Fig. 9. Enrichment of signaling molecules in adherent plasma membrane. Bars show relative enrichment of syk, PKC α , β_1 , δ and ζ in the adherent plasma membrane compared to the rest of the plasma membrane (see methods for calculations).

membrane as compared to the non-adherent plasma membrane. An unequal distribution of a signaling molecule in the plasma membrane would indicate a possible role for such a protein in localization of degranulation.

Fc-receptor-mediated stimulation of neutrophils with immune complexes results in a rapid tyrosine phosphorylation of several proteins [1, 31] and involvement of tyrosine phosphorylation in the triggering of degranulation has been proposed also in several other cell types [32-34]. Signal propagation from cross-linked Fc-receptors occurs by tyrosine phosphorylation of their ITAM motives [21] and a role for members of the src-family of tyrosine kinases in this event has been proposed [3]. Phosphorylated ITAMs can associate with several different tyrosine kinases containing SH2-domains and activation of Fc γ RIIA, in neutrophils and several other cell-types, induces the association, phosphorylation and activation of the tyrosine kinase syk [24]. Our finding that the release of azurophilic granule content triggered by immune complexes was reduced by inhibitors of tyrosine kinases is in agreement with the central role of tyrosine phosphorylations in Fc-receptor-mediated signaling and degranulation. Immunofluorescence data presented here show that tyrosine phosphorylation occurred mainly in the vicinity of the adherent plasma membrane, highly co-localized with azurophilic degranulation. Inhibition of actin filament-assembly diminished the accumulation of phosphorylated tyrosine, but did not affect its localization. In our system, syk was enriched in the adherent plasma membrane after 60 sec of adhesion. Our system did not exclude granules from the fraction containing non-adherent plasma membrane. The enrichment of syk in the adherent plasma membrane might be an underestimation, since part of the syk-content in the non-adherent plasma membrane could originate from granules. It is possible that altered distribution of syk or other proteins recruited to Fc-receptor-associated multi-protein complexes could

provide a localizing signal for azurophilic degranulation.

Fc-receptor activation by immune complexes results in elevated cytosolic Ca²⁺ and production of diacylglycerol [35-37] and conventional isoforms of PKC are activated by diacylglycerol in a Ca²⁺-sensitive manner. Release of azurophilic granule content was inhibited by pretreatment with GF109203X, an inhibitor specific for PKC that does not discriminate between isoforms [38]. At least 12 different isoforms of PKC have been described of which neutrophils express the α , β_1 , β_{II} , δ and ζ isoforms [39]. Besides differential modes of activation, the isoforms of PKC translocate to specific subcellular compartments upon activation [40]. PKC α has been detected in preparations of early phagosomes in monocytes [41] and PKC β_{II} , δ and ζ have been shown to translocate to membranes in neutrophils stimulated with opsonized zymosan [42]. The isoforms of PKC are primarily located in the cytosol in resting neutrophils but the isoforms β_{II} , δ and ζ have also been detected in granular fractions [42]. In neutrophils adhering to immune complexes, we found PKC α , β_1 , δ and ζ in the plasma membrane. The conventional isoforms, α and β_1 , accumulated in the adhering part of the plasma membrane, whereas isoforms δ and ζ were not enriched at this site. It can be noted that a slight shift in electrophoretic mobility of some PKC isoforms upon activation has been described earlier [43, 44]. A possible granular location of PKC isoforms would lead to an underestimation of the enrichment of PKC in the adherent aspect of the cells, since the enrichment was normalised using plasma membrane markers.

Our data and several recent studies describe translocation of PKC to sub-cellular locations where azurophilic degranulation takes place [41, 45]. The inhibition of azurophilic degranulation by GF109203X and the enrichment of the conventional isoforms α and β_1 of PKC observed in the present study indicate a role for PKC in triggering and possibly also in localizing azurophilic degranulation.

Acknowledgements:

This work was supported in part by the Swedish Medical Research Council (grants nr. 12182, 12613, and 05410), the Magnus Bergvall Foundation, the Crafoord Foundation, the Greta and Johan Kock Foundation, the Kungliga Fysiografiska Sällskapet, the Åke Wiberg Foundation, and the Alfred Österlund Foundation.

REFERENCES

- [1] Richard, S., Shaw, A.S., Showell, H.J., Connelly, P.A. (1994) *Biochem. Biophys. Res. Commun.* **199**, 653-61
- [2] Huizinga, T.W., Dolman, K.M., van der Linden, N.J., Kleijer, M., Nuijens, J.H., von dem Borne, A.E., Roos, D. (1990) *J. Immunol.* **144**, 1432-7
- [3] Ibarrola, I., Vossebeld, P.J., Homburg, C.H., Thelen, M., Roos, D., Verhoeven,

- A.J. (1997) *Biochim. Biophys. Acta* **1357**, 348-58
- [4] Turner, M., Schweighoffer, E., Calocci, F., Di Santo, J. P., Tybulewicz, V. L. (2000) *Immunol. Today* **21**, 148-54
- [5] Della Bianca, V., Grzeskowiak, M., Dusi, S., Rossi, F. (1993) *Biochem. Biophys. Res. Commun.* **196**, 1233-9
- [6] Edberg, J.C., Moon, J.J., Chang, D.J., Kimberly, R.P. (1998) *J. Biol. Chem.* **273**, 8071-9
- [7] Borregaard, N., Løllike, K., Kjeldsen, L., Sengelov, H., Bastholm, L., Nielsen, M.H., Bainton, D.F. (1993) *Eur. J. Haematol.* **51**, 187-98
- [8] Korchak, H.M., Vienne, K., Rutherford, L.E., Wilkenfeld, C., Finkelstein, M.C., Weissmann, G. (1984) *J. Biol. Chem.* **259**, 4076-82
- [9] Lew, P.D., Monod, A., Waldvogel, F.A., Dewald, B., Baggiolini, M., Pozzan, T. (1986) *J. Cell Biol.* **102**, 2197-204
- [10] Sengelov, H., Kjeldsen, L., Borregaard, N. (1993) *J. Immunol.* **150**, 1535-43
- [11] Smolen, S.E., Sandborg, R.R. (1990) *Biochim. Biophys. Acta* **1052**, 133-142
- [12] Niessen, H.W., Verhoeven, A.J. (1994) *Biochim. Biophys. Acta* **1223**, 267-73
- [13] Zigmund, S.H., Hirsch, J.G. (1972) *Exp. Cell Res.* **73**, 383-93
- [14] Tapper, H., Grinstein, S. (1997) *J. Immunol.* **159**, 409-18
- [15] Hurley, W.L., Finkelstein, E., Holst, B.D. (1985) *J. Immunol. Methods* **85**, 195-202
- [16] Muzykantov, V.R., Kushnareva, T.A., Smirnov, M.D., Ruuge, E.K. (1993) *Biochim. Biophys. Acta* **1177**, 229-35
- [17] Loike, J.D., Silverstein, R., Wright, S.D., Weitz, J.I., Huang, A.J., Silverstein, S.C. (1992) *Ann. N. Y. Acad. Sci.* **667**, 163-72
- [18] Metzelaar, M.J., Wijngaard, P.L., Peters, P.J., Sixma, J.J., Nieuwenhuis, H.K., Clevers, H.C. (1991) *J. Biol. Chem.* **266**, 3239-45
- [19] Tetteroo, P.A., Bos, M.J., Visser, F.J., von dem Borne, A.E. (1986) *J. Immunol.* **136**, 3427-32
- [20] Indik, Z., Kelly, C., Chien, P., Levinson, A.I., Schreiber, A.D. (1991) *J. Clin. Invest.* **88**, 1766-71
- [21] Indik, Z.K., Park, J.G., Hunter, S., Schreiber, A.D. (1995) *Blood* **86**, 4389-99
- [22] Akiyama, T., Ogawara, H. (1991) *Methods Enzymol.* **201**, 362-70
- [23] Tapper, H., Sundler, R. (1995) *J. Leukoc. Biol.* **58**, 485-94
- [24] Agarwal, A., Salem, P., Robbins, K.C. (1993) *J. Biol. Chem.* **268**, 15900-5
- [25] Kiener, P.A., Rankin, B.M., Burkhardt, A.L., Schieven, G.L., Gilliland, L.K., Rowley, R.B., Bolen, J.B., Ledbetter, J.A. (1993) *J. Biol. Chem.* **268**, 24442-8
- [26] Isakov, N., Wange, R.L., Watts, J.D., Aebersold, R., Samelson, L.E. (1996) *J. Biol. Chem.* **271**, 15753-61
- [27] Yanaga, F., Poole, A., Asselin, J., Blake, R., Schieven, G.L., Clark, E.A., Law, C.L., Watson, S.P. (1995) *Biochem. J.* **311**, 471-8
- [28] Aunis, D., Bader, M.F. (1988) *J. Exp. Biol.* **139**, 253-66
- [29] Boyles, J., Bainton, D.F. (1981) *Cell* **24**, 905-14
- [30] Muallem, S., Kwiatkowska, K., Xu, X., Yin, H.L. (1995) *J. Cell Biol.* **128**, 589-98
- [31] Connelly, P.A., Farrell, C.A., Merenda, J.M., Conklyn, M.J., Showell, H.J. (1991) *Biochem. Biophys. Res. Commun.* **177**, 192-201
- [32] Anel, A., Richieri, G.V., Kleinfeld, A.M. (1994) *J. Biol. Chem.* **269**, 9506-13
- [33] Kato, M., Abraham, R.T., Kita, H. (1995) *J. Immunol.* **155**, 357-66
- [34] Kita, H., Kato, M., Gleich, G.J., Abraham, R.T. (1994) *J. Allergy Clin. Immunol.* **94**, 1272-81
- [35] Molad, Y., Haines, K.A., Anderson, D.C., Buyon, J.P., Cronstein, B.N. (1994) *Biochem J* **299**, 881-7
- [36] Reibman, J., Haines, K.A., Gude, D., Weissmann, G. (1991) *J. Immunol.* **146**, 988-96
- [37] Walker, B.A., Hagenlocker, B.E., Stubbs, E.B., Sandborg, R.R., Agranoff, B.W., Ward, P.A. (1991) *J. Immunol.* **146**, 735-41
- [38] Toulllec, D., Pianetti, P., Coste, H., Bellevergue, P., Grand-Perret, T., Ajakane, M., Baudet, V., Boissin, P., Boursier, E., Loriolle, F., et al. (1991) *J. Biol. Chem.* **266**, 15771-81
- [39] Kent, J.D., Sergeant, S., Burns, D.J., McPhail, L.C. (1996) *J. Immunol.* **157**, 4641-7
- [40] Dekker, L.V., Parker, P.J. (1994) *Trends Biochem. Sci.* **19**, 73-7
- [41] Zheleznyak, A., Brown, E.J. (1992) *J. Biol. Chem.* **267**, 12042-8
- [42] Sergeant, S., McPhail, L.C. (1997) *J. Immunol.* **159**, 2877-85
- [43] Olivier, A. R., Parker, P. J. (1994) *J. Biol. Chem.* **269**, 2758-2763
- [44] Ohno, S., Mizuno, K., Adachi, Y., Hata, A., Akita, Y., Akimoto, K., Osada, S., Hirai, S., Suzuki, K. (1994) *J. Biol. Chem.* **269**, 17495-17501
- [45] Zheng, L., Zomerdijk, T.P., Aarnoudse, C., van Furth, R., Nibbering, P.H. (1995) *J. Immunol.* **155**, 776-84



Regulation of lysosomal pH in macrophages via phosphatidylinositol 3-kinase and protein kinase C

Claes Nauclicr and Roger Sundler

Department of Cell and Molecular Biology, Lund University, BMC B11, Sölvegatan 19, S-22362 Lund, Sweden.
Fax: +46-46-2224022 E-mail: claes.nauclicr@medkem.lu.se

Abstract: A rise in lysosomal pH acts to trigger lysosomal secretion in mouse macrophages. As shown here, lysosomal alkalinization induced by yeast-derived zymosan beads was not dependent on phagocytosis and thus not a result of fusion between phagosomes and lysosomes. The lysosomal alkalinization was reduced in the presence of the phorbol ester PMA. This effect of PMA on lysosomal pH was transient, its disappearance correlated to the downregulation of conventional isoforms of protein kinase C (PKC) and the effect was abrogated by cellular depletion of Ca^{2+} . PMA-induced modulation of lysosomal pH was prevented by inhibition of phosphatidylinositol 3-kinase (PI3K) by wortmannin. Upon subsequent fractionation, the conventional isoforms α and β were found to cofractionate with lysosomes in cells stimulated with PMA. PMA-induced appearance of these isoforms on lysosomes was prevented by wortmannin. The role of PI3K, PKC and the modulation of lysosomal pH for the process of lysosomal secretion is further discussed in our accompanying article [Nauclicr and Sundler "Modulation of lysosomal secretion..."].

Key Words: lysosome, pH, macrophage, zymosan, protein kinase C, phosphatidylinositol 3-kinase

INTRODUCTION

Macrophages take part in the first line of defence against infections and mediate an inflammatory response through production and release of mediators such as cytokines, eicosanoids, reactive oxygen species and lysosomal enzymes. Zymosan, a cell wall preparation from *Saccharomyces cerevisiae*, is one of several stimuli widely used in studies of pathogen-induced responses in macrophages. Stimulation of mouse peritoneal macrophages with zymosan has been shown to induce lysosomal alkalinization, which in turn triggers a PKC-dependent release of lysosomal enzymes [1]. The mechanism for the PKC dependence has, however, remained unknown. Activation of PI3K and phospholipase C (PLC) are two early steps in zymosan-induced signaling in macrophages [2]. PLC generates diacylglycerol (DG) and inositol 3-phosphate with subsequent elevation of intracellular Ca^{2+} . Mouse macrophages express at

least 5 isoforms of PKC [3, 4]. PKC α and β are conventional isoforms dependent on Ca^{2+} and activated by DG. PKC δ and ϵ are novel isoforms activated by DG but not dependent on Ca^{2+} . PKC ζ is an atypical isoform, independent of Ca^{2+} and DG [5].

The aim of this study was to further investigate the role of PKC and the potential role of PI3K in zymosan-induced regulation of lysosomal pH.

MATERIALS AND METHODS

Materials

4-Methylumbelliferyl N-acetyl- β -D-glucosaminide (umb-NAG), 4-Methylumbelliferyl phosphate (MUP) Free Acid, wortmannin, fluorescein isothiocyanate (FITC), FITC dextran MW 40000 (FD), FITC concanavalin A and zymosan were purchased from Sigma (St Louis, MO, U.S.A.). Phorbol-12-myristate-13-acetate (PMA) and trichloroacetic acid (TCA) were from ICN (Costa Mesa, CA, U.S.A.). GF109203X was purchased from Calbiochem (La Jolla, CA, U.S.A.). Percoll was from Pharmacia Biotech (Uppsala, Sweden) and Optiprep from Nycomed Pharma (Oslo, Norway). Rabbit polyclonal antibodies against PKC α and δ were purchased from Santa Cruz Biotechnology (Santa Cruz, CA, U.S.A.). The monoclonal antibodies against PKC β and ϵ were from Transduction Labs (Lexington, KY, U.S.A.). The monoclonal antibody against FITC was purchased from Sigma (St Louis, MO, U.S.A.). Cytochalasin B was purchased from Fluka (Switzerland).

Solutions

Na-medium contained the following (in mM): NaCl, 127; KH_2PO_4 , 1.2; KCl, 5.4; $MgSO_4$, 0.8; $CaCl_2$, 1.8; glucose, 5.6; 4-(2-hydroxyethyl)-1-piperazine-ethanesulfonic acid (HEPES), 10; and pH was adjusted with NaOH to 7.2. Ca-free medium was identical with Na-medium except the addition of 0.1 mM EGTA and absence of $CaCl_2$. Ca-medium was made by adding 0.2 mM $CaCl_2$ to Ca-free medium. Homogenizationbuffer contained 0.25 M sucrose, 10 mM HEPES, 0.5 mM EDTA and pH was adjusted using NaOH to 7.4. Percoll gradient contained 0.25 M sucrose, 10 mM HEPES, 35% percoll and pH was adjusted to 7.4 using NaOH. 50% optiprep was prepared by mixing 5 parts optiprep with one part buffer containing 0.25 M sucrose, 3 mM EDTA, 60 mM

HEPES, pH 7.4. The 50% optiprep was diluted to 25% with a buffer containing 0.25 M sucrose, 10 mM HEPES, 0.5 mM EDTA, pH 7.4.

Cell harvest and culture

Four milliliters of Medium 199 containing 1% heat-inactivated fetal calf serum was used for peritoneal lavage of female outbred NMRI mice (Bommice, Copenhagen, Denmark). Macrophages pooled from 6–12 mice were used for each experiment. The peritoneal cells thus obtained were adhered for 2 h at 37°C in a humidified atmosphere containing 5% CO₂. Thereafter, non-adherent cells were washed away with PBS. Medium 199 (2 ml) containing 10% serum was then added to each well and the cells were further cultured for 20 h.

Immunofluorescence microscopy and measurements of phagocytosis

Zymosan was labeled by incubating 15 mg zymosan with 1.5 mg FITC in 15 ml 0.1 M Na₂CO₃/NaHCO₃ buffer pH 9 for 2.5 h at room temperature. Zymosan was then washed 5 times in PBS. Macrophages were adhered to 19-mm coverslips and cultured as described over night. Experiments were performed in Na-medium with a 15 min incubation with or without cytochalasin B prior to stimulation. Cells were then stimulated with FITC-labeled zymosan for 15 min and then put on ice, washed twice in cold PBS, and fixed with 1% paraformaldehyde (Becton Dickinson, Franklin Lakes, NJ) for 20 min on ice and for an additional 100 min at room temperature. After two washes in PBS, the cells were blocked for 3 h in PBS containing 5% donkey serum (Sigma, St. Louis, MO) at room temperature. Cells were labeled with the antibody against FITC at a dilution of 1:200 in PBS containing 1% BSA at room temperature for 1h, washed twice, and probed with an anti-mouse Cy3 secondary antibody (Jackson Immunoresearch Laboratories, West Grove, PA) at 1:800 dilution for 1 h at room temperature. Coverslips were then washed three times and mounted with anti-fade mounting medium (DAKO, Carpinteria, CA) for microscopic observation. Images were recorded on a Nikon Eclipse TE300 inverted fluorescence microscope equipped with a Hamamatsu C4742-95 cooled CCD camera, using a Plan APOchromat 3100 objective and a high N.A. oil condenser. The percentage of phagocytosed particles was counted manually.

Measurements of lysosomal pH

Cells were cultured overnight on 10 mm coverslips as previously described but in the presence of 0.5 mg/ml FD. This pH-sensitive fluorescent probe is pinocytosed and accumulated in the lysosomal compartment. All measurements were performed on a SLM 8000 spectrofluorometer equipped with magnetic stirring and a thermostated perfusion system for control of media temperature and flow rate. Coverslips were

placed in Na-medium without serum at 37°C for 30 min before experiments to allow recently pinocytosed FD to enter the lysosomal compartment. The coverslips were then placed in a specially designed holder in a standard fluorescence cuvette holding a volume of 2 ml through which the experimental medium was perfused at a flow rate of 1 ml/min. Fluorescence ratio was measured at wavelengths for excitation set to 497/456 nm and for emission to 518 nm. Calibration was performed in Na-medium containing 0.1 µg/ml FD at pH between 4 and 8.

Preparation of cellular fractions

12×10⁶ macrophages were scraped in 1 ml homogenization buffer, spun down at 800g for 10 min, resuspended and disrupted by nitrogen cavitation at 400 psi for 10 min. Unbroken cells were spun down at 800g for 10 min. The supernatant was layered upon 5.5 ml of 35% percoll solution with 0.5 ml 2.5 M sucrose at the bottom. The percoll was centrifuged at 40000g for 60 min in a 70.1Ti rotor (Beckman). Fractions were collected from the top of the gradient. 10 fraction of 0.65 ml each were collected for assessment of markers for plasma membrane, endosomes and lysosomes. For western blot analysis three fractions of 1.95 ml each were collected from the top. The first fraction was discarded directly and the other two were mixed with equal volume of 50% optiprep in a centrifuge tube. A layer of 1.5 ml 25% optiprep followed by a layer of 1.5 ml homogenization buffer was placed on top. Organells were then cleared from percoll by floatation at 75000g for 60 min. Membranes were recovered in the interface between 25% optiprep and homogenization buffer and proteins were precipitated using 6% TCA and 0.1% triton-X100 and then boiled in Laemmli's sample buffer for 10 min [6].

Assays for detection of membrane markers

FD, loaded into cells for 20 h (0.5 mg/ml) followed by a 30 min chase, was used as a marker for lysosomes. Subcellular fractionation was performed as described above. Alkaline phosphatase and FITC-conjugated concanavalin A were used as markers for plasma membranes. Cells were treated with 0.1 mg/ml FITC-conjugated concanavalin A at room temperature or on ice for 20 min in Na-medium. Adherent cells were washed 3 times in PBS before scraping and subcellular fractionation. Fractional content of FD and FITC-conjugated concanavalin A were analyzed in a SLM8000 spectrofluorometer using the wavelengths 490 nm for excitation and 525 for emission. Alkaline phosphatase was assessed using 4-methylumbelliferyl phosphate (MUP) as substrate. A 280 µl sample was taken from each fraction and mixed with 200 µl substrate buffer containing 0.2% BSA, 73 µM MUP and 0.1 M Tris pH 8. The reaction was carried out at 37°C for 60 min and was then stopped by adding 1.52 ml 0.2 M

Na₂CO₃. Measurements were made in the spectrofluorometer using wavelengths set to 358 nm for excitation and 450 nm for emission.

Electrophoresis, Western blot analysis and semi-quantitative protein density measurements

Samples obtained from subcellular fractionation were subjected to sodium dodecyl sulfate (SDS)-polyacrylamide gel electrophoresis according to the method of Laemmli [6], using 1.5-mm slab gels. Separation and stacking gels contained 8 and 3% polyacrylamide, respectively. Proteins were separated at 12 mA for 20 h and then electrophoretically transferred to PVDF membranes (Millipore, Bedford, MA) at 100 V for 2 h. All membranes were blocked by incubation in 3% gelatin (Bio-Rad, Hercules, CA) for 2 h except when analyzing PKC ϵ where 1% BSA in TTBS (10 mM Tris, 150 mM NaCl, pH 7.5 with addition of 0.1% tween-20) for 2 h was used. Primary antibodies for PKC α , β , δ and ϵ were used at dilutions 1:1000, 1:250, 1:500 and 1:500 in TTBS over night. Secondary antibodies against mouse and rabbit were used for 1 h at dilution 1:3000 in TTBS. Bands were detected by chemiluminescence using Super Signal (Pierce, Rockford, IL). Multiple exposures were performed to obtain films without visible saturation of signals. Bands were then scanned using an AGFA SnapScan 1236s and analyzed using NIH image software (NIH, Bethesda, Maryland, U.S.A.). Backgrounds were subtracted to obtain protein densities which were then related to protein densities in lanes containing control cells.

RESULTS

Zymosan and signaling to lysosomal alkalization

Stimulation of macrophages with zymosan led to alkalization of lysosomes (figure 1). An immunofluorescence technique was used to monitor phagocytosis of zymosan. While control cells effectively ingested zymosan particles regardless whether zymosan was attached centrally or along lamellipodiae, cells treated with cytochalasin B showed a significantly reduced capacity for phagocytosis even of particles attached at central locations (figure 2 a-e). Reduction of phagocytosis was not associated with a reduced number of particles associated with each cell (not shown). Cell-free control experiments were performed which assured that zymosan was homogeneously tagged with FITC and that the red fluorescent antibody against FITC effectively labeled all particles (not shown). Cellular interaction with non-phagocytosed particles still led to a lysosomal alkalization (pH 5.22 ± 0.02 , SEM $n=3$) comparable to that seen in cells not treated with cytochalasin B (pH 5.26 ± 0.02 , SEM $n=3$). It should be noted that cytochalasin B

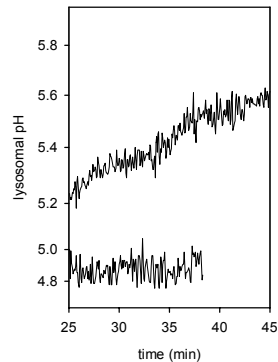

Fig. 1. Zymosan-induced lysosomal alkalization. The upper trace shows lysosomal pH in zymosan-stimulated macrophages. Macrophages on coverslips were presented to 200 $\mu\text{g/ml}$ zymosan for 25 min in Na-medium and coverslips were then placed in a perfused cuvette for spectrofluorometrical measurement of lysosomal pH. The lower trace shows lysosomal pH in non-stimulated macrophages.

by itself did not affect lysosomal pH in non-stimulated macrophages (not shown). Hence, receptor-mediated signaling rather than interaction of phagosomes with lysosomes is the likely mechanism of zymosan-induced lysosomal alkalization. Inhibition of phagocytosis by cytochalasin B did not block zymosan-induced lysosomal secretion. On the contrary, lysosomal secretion stimulated by zymosan for 60 min was greatly enhanced in the presence of cytochalasin B. Cytochalasin B alone did not elicit a secretory response (figure 2f).

Modulation of lysosomal pH by protein kinase C

Lysosomal pH in resting macrophages was 4.93 ± 0.02 (SEM, $n=9$) but it should be noted that this is in the lower range of what can be accurately measured using FITC. Stimulation with zymosan for 30 min resulted in a lysosomal pH of 5.27 ± 0.03 (SEM, $n=8$). Simultaneous stimulation of PKC with the phorbol ester PMA (100 nM) diminished the zymosan-induced alkalization (figure 3). This effect was also seen after treatment with 100 nM PMA for 1 h prior to zymosan stimulation. After 4 h of treatment a lowering of lysosomal pH was no longer seen. The expression of PKC and its down-regulation by PMA was monitored by Western blotting. At least four isoforms of PKC sensitive to PMA were expressed in mouse peritoneal macrophages. These were the conventional isoforms α and β and the novel isoforms δ and ϵ (not shown). α and β were most sensitive to down-regulation by treatment with PMA. More than 50% (estimated from Western blots) was lost within 1 h of treatment with 100 nM PMA (figure 4). A near

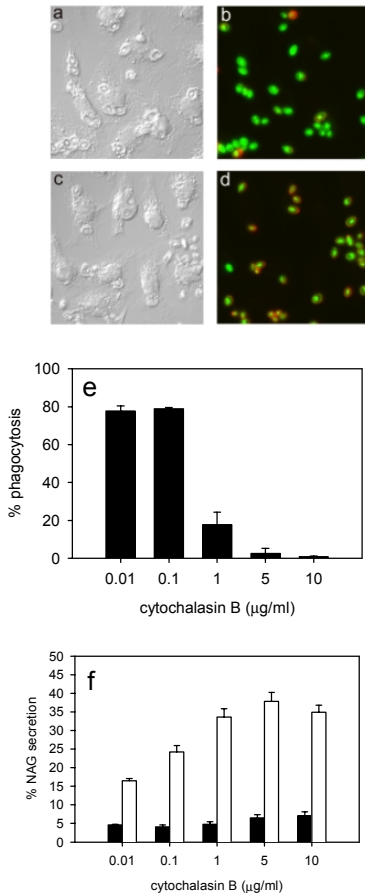

Fig. 2. Effects of cytochalasin B on phagocytosis and lysosomal secretion. Cells were stimulated with 150 μg/ml FITC-labeled zymosan for 15 min (green fluorescence). (a) and (b) show control cells and (c) and (d) show cells treated with cytochalasin B 1 μg/ml for 15 min prior to stimulation. An anti-FITC antibody followed by a Cy3-tagged secondary antibody was used to label non-phagocytosed zymosan (red fluorescence). Fluorescence images are shown in (b) and (d). (a) and (c) are DIC-images of the same cells. (e) shows the effect of cytochalasin B on phagocytosis. Phagocytosis is presented as the percentage of cell-associated particles that has been ingested after 15 min of stimulation with 150 μg/ml zymosan. Error bars denote SEM, n=3. (f) shows the effect of cytochalasin B on release of the lysosomal enzyme NAG induced by 600 μg/ml zymosan for 60 min (open bars). Secretion is presented as percentage of total cellular enzyme content. Filled bars denote secretion upon treatment with cytochalasin B only. Experimental variations are shown as SEM for control cells (n= 31, 3, 4, 3, 4) and cells stimulated with zymosan (n= 28, 4, 5, 4, 5).

complete down-regulation was seen after 4 h of treatment. PKC δ was still detectable after 8 h. PKC ε was not completely down-regulated within 20 h of treatment with 100 nM PMA. Inhibition of PKC by 1 μM GF109203X for 15 min did not affect lysosomal pH in resting cells (4.95±0.02, SEM n=3) but enhanced zymosan-induced lysosomal alkalization to pH 5.51±0.06 (SEM, n=8).

PI3K and regulation of lysosomal pH

PI3K plays a central role in macrophage signaling. We used the inhibitor wortmannin to investigate a potential role for PI3K in the regulation of lysosomal pH. Treatment with 100 nM wortmannin for 15 min only slightly lowered zymosan-induced lysosomal alkalization (figure 5) and did not by itself affect resting lysosomal pH. Surprisingly, this treatment blocked the effect of PMA on zymosan-induced lysosomal pH. Hence, PMA did not reduce zymosan-induced alkalization after treatment with wortmannin. Neither after 1 h of treatment with 100 nM PMA was a lowered lysosomal alkalization seen in the presence of wortmannin.

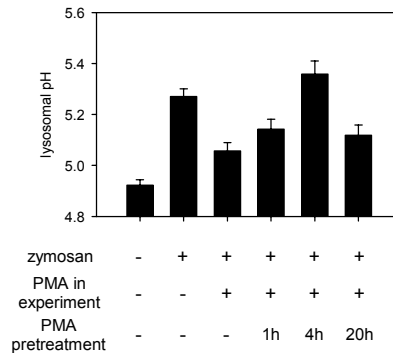

Fig. 3. Effects of PMA-induced stimulation and downregulation of PKC on lysosomal pH. Zymosan 600 μg/ml was added 30 min before measurements. 100 nM PMA was used both in the culture-media for downregulation of PKC and as stimulus in the Na-medium added at the same time as zymosan. Experimental variations are shown as SEM (n= 8, 8, 7, 4, 9, 7).

Effects of Ca²⁺-depletion on lysosomal pH

As conventional isoforms of PKC are sensitive to calcium we performed measurements of lysosomal pH in cells treated with the ionophore A23187 in a medium devoid of calcium and supplemented with EGTA. These conditions enhanced zymosan-induced lysosomal alkalization (figure 6) but wortmannin was still effective resulting in a lysosomal pH resembling the level seen in zymosan-stimulated cells treated with wortmannin in the presence of calcium. Interestingly, part of the

negative effect of PMA on lysosomal alkalization was lost in calcium-depleted cells.

Translocation of conventional PKC isoforms to lysosomes

The correlation between down-regulation of the α and β isoforms of PKC with the transient suppression of lysosomal alkalization caused by PMA prompted us to study the association of these isoforms with lysosomes. Macrophages disrupted by nitrogen cavitation were centrifuged in Percoll to obtain purified subcellular fractions. Plasma membranes were identified in fractions 4 through 6

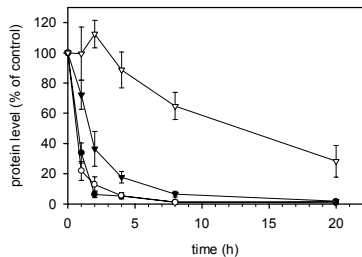

Fig. 4. Down-regulation of PKC isoforms. Cells were cultured in the presence of 100 nM PMA for 1, 2, 4, 8 and 20 h before lysis and Western blot analysis. Protein densities were obtained as described in *methods*. Values are presented as percent of signal obtained from non-treated cells. The figure shows down-regulation of PKC α (filled circles, SEM $n=10, 7, 5, 10, 5, 7$), β (open circles, SEM $n=12, 9, 6, 12, 4, 9$), δ (filled triangles, SEM $n=14, 10, 7, 14, 5, 10$) and ϵ (open triangles, SEM $n=6, 5, 3, 6, 3, 5$).

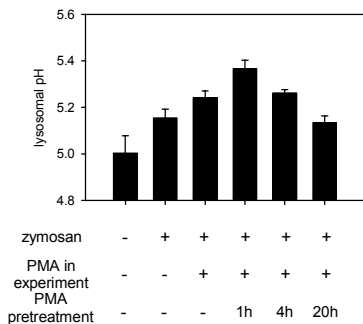

Fig. 5. Effects of wortmannin on lysosomal pH. Cells were incubated in Na-medium with addition of 100 nM wortmannin at 37°C for 45 min prior to measurements of lysosomal pH. Zimosan 600 $\mu\text{g/ml}$ was added 30 min before measurements. 100 nM PMA was used both in the culture-media for down-regulation of PKC and as stimulus in the Na-medium added at the same time as zimosan. Experimental variations are shown as SEM ($n=3, 7, 4, 4, 6, 5$).

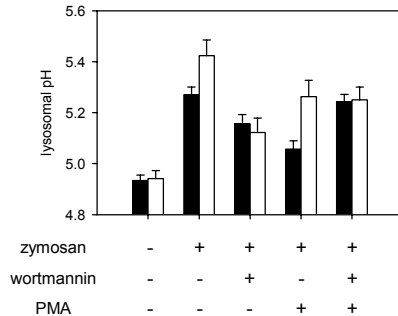

Fig. 6. The role of intracellular Ca^{2+} in PKC-mediated regulation of lysosomal pH. Experiments were performed in Na-medium (filled bars) or Ca-free medium where cells were pretreated for 15 min with addition of 1 μM A23187 (open bars). Wortmannin 100 nM was also added 15 min prior to stimulation. Cells were then stimulated for 30 min with 600 $\mu\text{g/ml}$ zimosan with or without addition of 100 nM PMA. Experimental variations are presented as SEM for filled bars ($n=9, 8, 7, 7, 4$) and open bars ($n=3, 5, 4, 3, 3$).

using alkaline phosphatase and pre-loaded FITC-conjugated concanavalin A as markers (figure 7b and c). Fractions 4 through 6 were pooled and designated light fraction. Lysosomes were identified using FD as a marker (figure 7a). In this case the probe was loaded into cells over night followed by a 30 min chase. Lysosomes were found in fractions 7 through 9. These fractions were pooled and designated heavy fraction. Light and heavy fractions were analyzed through Western blotting using antibodies specific for PKC isoforms.

An increase in signals of the PKC isoforms β , δ and ϵ was found in the light fraction following stimulation with 600 $\mu\text{g/ml}$ zimosan for 15 min. No signal could be detected in heavy fractions in control cells and cells stimulated with zimosan. However, when zimosan-treated cells were co-stimulated with 100 nM PMA, PKC α and β were found also in heavy fractions. This lysosomal translocation was abolished by treatment for 15 min with 100 nM wortmannin prior to stimulation. Occasionally PKC δ was also found in the heavy fraction from cells co-stimulated with zimosan and PMA but this was then never prevented by treatment with wortmannin.

DISCUSSION

The low pH of lysosomes, maintained by the vacuolar type H^+ -ATPase [7], plays a role in the import and release of vesicular cargo and creates a milieu where lysosomal enzymes can degrade endocytosed material. In macrophages it has also been shown that lysosomal pH controls transport

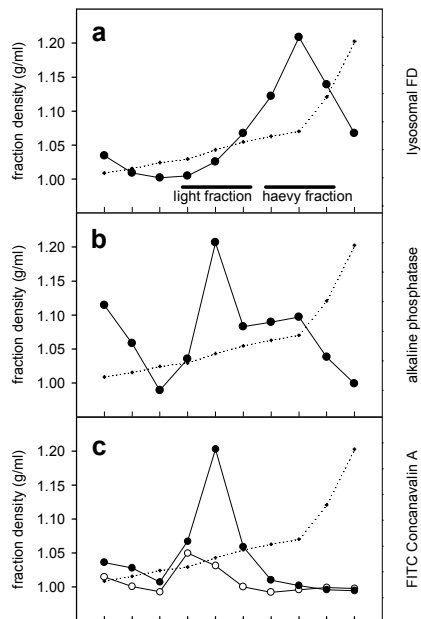

Fig. 7. Distribution of membrane markers in subcellular fractions. (a) shows the localization of lysosomes represented by FD pinocytosed over night. (b) shows distribution of alkaline phosphatase which is a marker for plasma membrane. (c) shows distribution of preloaded concanavalin A which is also a marker for plasma membrane. Concanavalin A was loaded at 4°C (open circles) or at 37°C (filled circles) for 20 min.

of lysosomal content in the opposite direction where stimuli inducing lysosomal alkalization trigger extracellular release of lysosomal enzymes [8]. As yet, not much is known about the regulation of the vacuolar H^+ -ATPase or the possible existence of additional mechanisms for regulation of lysosomal pH in macrophages. Zymosan is a particulate stimulus widely used in experimental inflammatory models. The receptors engaged by zymosan in macrophages are hitherto only characterized indirectly. The binding of zymosan to macrophages is competitively inhibited by soluble fragments of β -glucan [9], one of the major constituents of the yeast cell wall [10]. Several Toll-like-Receptors (TLR) with roles in innate immunity have been cloned and TLR-2 was recently proposed as a putative receptor for zymosan in macrophages [11]. Ingestion of zymosan is initiated by outgrowth of pseudopod extensions. This embrace is supported by the underneath formation of actin filaments forming a phagocytic cup, which also provides force for the completion of phagocytosis. We show that zymosan induced a gradual lysosomal alkalization in macrophages.

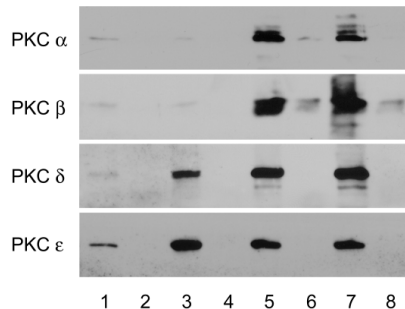

Fig. 8. Subcellular distribution of PKC isoforms. Subcellular fractions were analyzed by western blots using isoform specific antibodies for PKC α , β , δ and ϵ . Lanes 1 and 2 show control cells. Lanes 3 and 4 show cells treated with zymosan (600 μ g/ml for 15 min). Lanes 5 and 6 show cells treated with zymosan and PMA (100 nM for 15 min). Lanes 7 and 8 show cells pretreated with wortmannin (100 nM for 15 min) prior to stimulation with 600 μ g/ml zymosan and 100 nM PMA for 15 min. Lanes 1, 3, 5 and 7 contain light fractions. Lanes 2, 4, 6 and 8 contain heavy fractions.

By treating cells with cytochalasin B, an inhibitor of actin polymerization, phagocytosis was effectively blocked while the number of particles bound per cell was largely unaffected. Cytochalasin B blocks phagocytosis by preventing actin polymerization necessary for the extension of pseudopods [12]. The binding of zymosan at the cell surface was sufficient for induction of lysosomal alkalization. This points to receptor engagement and signaling rather than subsequent phago-lysosomal fusion as being responsible for effects on lysosomal pH. It also argues against the possibility that the process of phagocytosis per se or through signaling would trigger lysosomal alkalization. Our aim was then to further characterize signaling pathways involved in the zymosan-induced lysosomal alkalization. Cytochalasin B was found to enhance zymosan-induced lysosomal secretion. A similar effect on lysosomal secretion induced by opsonized zymosan has been shown in monocytes [13]. One explanation of this phenomenon could be that fusion of lysosomes normally occurs with both plasma membrane and phagosome membrane of which only the former would be detected in our assay.

Macrophages stimulated with zymosan produce DG and inositol phosphates leading to an elevated concentration of intracellular Ca^{2+} [14-16] and activation of PKC. Most often, multiple isoforms of PKC are found in a single cell-type. Not only do these isoforms partly differ in pattern of activation but also in terms of preferred substrate sequence [17]. This calls upon designating isoforms with distinct functions within the cell. The expression of PKC α , β , δ and ϵ as well as ζ has been demonstrated in mouse macrophages [3, 4].

We used the phobol ester PMA to investigate the effect of activation and down-regulation of PKC on the regulation of lysosomal pH. PMA strongly inhibited zymosan-induced lysosomal alkalinization. As isoforms were down-regulated during prolonged incubation with PMA, lysosomal alkalinization was again readily inducible by zymosan. The decline in PMA-induced lowering of lysosomal pH coincided with the down-regulatory patterns of the conventional isoforms of PKC. After 4 h of incubation with PMA, when more than 95% of the α and β isoforms were down-regulated while approximately 20% of δ still remained, no effect was seen on lysosomal pH. A much slower down-regulation was seen for PKC ϵ , still expressed after 20 h of treatment with PMA. Conclusions from these experiments cannot be drawn without caution since substrates and the levels of PKC required for full activation of such substrates is not known. Next, we studied lysosomal pH in cells depleted of Ca^{2+} . Conventional isoforms of PKC are sensitive to Ca^{2+} [5] and we show in our accompanying article in this issue that Ca^{2+} -depletion indeed has a distinct effect on zymosan-induced translocation of PKC α and β [18]. Measurements of lysosomal pH revealed that Ca^{2+} -depletion enhanced zymosan-induced lysosomal alkalinization and diminished the acute effect of PMA on pH. We found in our accompanying article that stimulation of macrophages with PMA in addition to zymosan induces a near complete translocation of PKC to membranes. Interestingly, only PMA-induced translocation of PKC α was affected by depletion of Ca^{2+} [18]. We also looked for isoforms of PKC in direct association with lysosomes purified on continuous Percoll gradients. Zymosan did not alone cause detectable PKC-translocation to lysosomes. Addition of PMA on the other hand caused significant translocation to plasma membrane and also translocation of PKC α and β to lysosomes.

PI3K plays an important role in signal transduction in many different cell-types. Stimulation of macrophages with zymosan results in activation of PI3K [2]. This is an early signaling step controlling functions such as phagocytosis and production of superoxide anions and lipid metabolites for prostaglandin synthesis [2, 12, 19]. The specific inhibitor, wortmannin, was used to investigate the involvement of PI3K in zymosan-induced lysosomal alkalinization. Inhibition of PI3K resulted in lowered zymosan-induced lysosomal alkalinization thus pointing out its role in signaling that regulates lysosomal pH. Inhibition of PI3K when stimulating cells with both zymosan and PMA, on the other hand, revealed an additional opposite role for PI3K. In this case inhibition of PI3K prevented the lowering of zymosan-induced lysosomal pH caused by activation of PKC. Hence, PI3K might also convey acidifying signals through the action of PKC. This opens for the possibility of a second pool of PI3K acting downstream of PKC,

closer to the lysosome. This might not be the correct explanation since inhibition of PI3K prevented PKC α and β from appearing in the lysosomal fraction, indicating an upstream role of PI3K in activation of conventional isoforms of PKC. The ability of wortmannin to inhibit different PMA-induced responses in various cell-types has recently been noted in other studies [20, 21].

Taken together, zymosan-induced signaling through PI3K involves both an alkalinizing signal and an acidifying signal through activation of PKC. The pattern of down-regulation of PKC in comparison to the temporal aspects of the effect of PMA on lysosomal pH points to the isoforms α and β rather than δ and ϵ in transduction of the acidifying signal. These isoforms were also the ones found on purified lysosomes from PMA-stimulated cells and this translocation was inhibited by wortmannin. Depletion of Ca^{2+} slightly increased zymosan-induced lysosomal alkalinization and prevented the effect of PMA, which is consistent with the behavior of conventional isoforms [22]. Ascribing either α or β to this pathway is more difficult. The PMA-induced membrane translocation of PKC α , on one hand, was inhibited by depletion of Ca^{2+} , which was in agreement with inhibition of PMA-induced effects on lysosomal pH. The zymosan-induced translocation of this isoform, on the other hand, was both slower and less extensive compared to that of the β isoform. It is not certain that PKC plays a role in zymosan-induced regulation of lysosomal pH also in the absence of PMA. Inhibition of PKC by GF109203X, however, had an opposite effect on zymosan-induced lysosomal pH compared to PMA.

It is not clear through which mechanisms these signaling pathways regulate lysosomal pH. The zymosan-induced alkalinization could be a result of a direct inhibition of the H^+ -ATPase possibly by means of dissociating its V_1 -complex from the V_0 -complex. PKC has earlier been shown to accelerate extrusion of protons from the cytosol by the H^+ -ATPase regulating cytosolic pH [23]. The vacuolar type H^+ -ATPase is electrogenic and could also be regulated through opening channels for counterions [24].

Finally, it should be stressed that although PI3K and PKC acted as modulators of zymosan-induced lysosomal alkalinization, the data presented indicate the existence of additional signaling pathways acting in parallel as regulators of lysosomal pH. These pathways remain to be discovered.

Acknowledgements

We thank Pia Lundquist for excellent technical assistance and Dr Hans Tapper for help with microscopic evaluation of phagocytosis. This work was supported by a grant from the Swedish Medical Research Council (Project 5410), The Albert Pålsson Foundation, King Gustav V's 80-year foundation, The Greta and Johan Kock Foundation, The Royal Physiographic Society, The Crafoord Foundation and the Albert Österlund Foundation.

REFERENCES

- [1] H. Tapper, R. Sundler, *J. Leukoc. Biol.* **58** (1995) 485-494.
- [2] G. Hiller, M. Sternby, R. Sundler, J. Wijkander, *Biochim. Biophys. Acta* **1485** (2000) 163-172.
- [3] M.M. Monick, A.B. Carter, G. Gudmundsson, L.J. Geist, G.W. Hunninghake, *Am. J. Physiol.* **275** (1998) L389-L397.
- [4] A. Huwiler, J. Pfeilschifter, *Eur. J. Biochem.* **217** (1993) 69-75.
- [5] H. Mellor, P.J. Parker, *Biochem J.* **332** (1998) 281-292.
- [6] U.K. Laemmli, *Nature* **227** (1970) 680-685.
- [7] D.L. Schneider, *J. Biol. Chem.* **256** (1981) 3858-3864.
- [8] H. Tapper, R. Sundler, *Biochem. J.* **272** (1990) 407-414.
- [9] H. Tapper, R. Sundler, *Biochem. J.* **306** (1995) 829-835.
- [10] F.J. DiCarlo, J.V. Fiore, *Science* **127** (1957) 756-757.
- [11] D.M. Underhill, A. Ozinsky, A.M. Hajjar, A. Stevens, C.B. Wilson, M. Bassetti, A. Aderem, *Nature* **401** (1999) 811-815.
- [12] D. Cox, C.C. Tseng, G. Bjekic, S. Greenberg, *J. Biol. Chem.* **274** (1999) 1240-1247.
- [13] P.J. Keeling, P.M. Henson, *J. Immunol.* **128** (1982) 563-7.
- [14] A. Emilsson, R. Sundler, *J. Biol. Chem.* **259** (1984) 3111-6.
- [15] P. Dieter, E. Fitzke, *Eur. J. Biochem.* **218** (1993) 753-758.
- [16] M.J. Berridge, *Nature* **361** (1993) 315-25.
- [17] K. Nishikawa, A. Toker, F.-J. Johannes, Z. Songyang, L.C. Cantley, *J. Biol. Chem.* **272** (1997) 952-960.
- [18] C. Nauc ler, R. Sundler, Modulation of lysosomal secretion by protein kinase C in mouse macrophages.
- [19] A. Karlsson, J.B. Nixon, L.C. McPhail, *J. Leukoc. Biol.* **67** (2000) 396-404.
- [20] H. Oda, T. Murayama, Y. Nomura, *Arch. Biochem. Biophys.* **337** (1997) 96-102.
- [21] C. Huang, P.C. Schmid, W.Y. Ma, H.H. Schmid, Z. Dong, *J. Biol. Chem.* **272** (1997) 4187-94.
- [22] M. Wolf, H.d. LeVine, W.S.J. May, P. Cuatrecasas, N. Sahyoun, *Nature* **317** (1985) 546-549.
- [23] T.A. Heming, A. Bidani, *J. Leukoc. Biol.* **57** (1995) 600-608.
- [24] P. Harikumar, J.P. Reeves, *J. Biol. Chem.* **258** (1983) 10403-10410.



Modulation of lysosomal secretion by protein kinase C in mouse macrophages

Claes Nauc er and Roger Sundler

Department of Cell and Molecular Biology, Lund University, BMC B11, S lvegatan 19, S-22362 Lund, Sweden.
Fax: +46-46-2224022 E-mail: claes.naucer@medkem.lu.se

Abstract: The involvement of protein kinase C (PKC) in regulation of zymosan-induced lysosomal secretion in mouse peritoneal macrophages was investigated using phorbol-12-myristate-13-acetate (PMA). We show in our accompanying article that activation of conventional isoforms of PKC leads to a reduction in zymosan-induced lysosomal alkalization [Nauc er and Sundler "Regulation of lysosomal pH..."]. In this study the absence of effects of PMA on lysosomal secretion revealed a compensatory modulation of lysosomal secretion by PKC counteracting the effect of a reduction in lysosomal pH. The enhancing effect of PMA was even more evident when secretion was triggered by bafilomycin A₁-induced alkalization of lysosomes. The enhancement of zymosan-induced secretion was sensitive to depletion of intracellular Ca²⁺ and down-regulation of conventional isoforms of PKC but not sensitive to inhibition of phosphatidylinositol 3-kinase (PI3K) by wortmannin as was the case for PMA-induced effects on lysosomal pH.

Key words: lysosome, secretion, macrophage, zymosan, protein kinase C, phosphatidylinositol 3-kinase

INTRODUCTION

While the mechanisms regulating exocytosis in excitable cells have been much clarified over the past years our knowledge of the molecular mechanisms of exocytosis in inflammatory cells is still limited and contradictory. Little is known about the regulation of macrophage lysosomal secretion which in addition seems to differ in some crucial aspects from exocytosis in granulocytes. Macrophages secrete lysosomal enzymes in response to a broad variety of inflammatory stimuli [1]. Besides the immunological significance of lysosomal enzyme release from macrophages, a potentially detrimental effect through tissue remodeling and degradation can be anticipated in inflammatory diseases [2]. Lately, lysosomal secretion has again come into focus as a Ca²⁺-triggered plasma membrane repair-mechanism common to a broader spectrum of cell-types [3]. Macrophages secrete lysosomal enzymes in response to phagocytic stimuli such as zymosan. In macrophages, as opposed to exocytotic responses in other inflammatory cells,

lysosomal secretion is not triggered by elevation of intracellular Ca²⁺ and zymosan-induced secretion proceeds in macrophages depleted of Ca²⁺ [4]. Instead, elevation of lysosomal pH has been identified as a triggering signal for induction of exocytosis in macrophages [5]. Agents causing lysosomal alkalization through accumulation (primary amines), perturbation of ion equilibria (e.g. monensin and nigericin) and inhibition of the vacuolar proton pump (bafilomycin A₁) all trigger lysosomal secretion in macrophages [5-7]. Zymosan also causes lysosomal alkalization and release of lysosomal content. This stimulation, however, acts synergistically with other agents causing lysosomal alkalization which implies additional zymosan-induced signaling pathways modulating lysosomal secretion [6, 7]. Upon zymosan stimulation of macrophages phosphoinositide turnover leading to intracellular elevation of Ca²⁺, production of diacyl glycerol (DG) and activation of PKC occurs. Macrophages express at least 5 isoforms of PKC [8, 9] of which α and β are conventional isoforms sensitive to Ca²⁺ and DG, δ and ϵ are novel isoforms activated by DG and ζ is an atypical isoform not sensitive to Ca²⁺ or DG [10]. Although differences with regard to substrate preferences have been shown [11] unique functions among the isoforms are also likely to be a consequence of differential activation and localization within the cell. The aim of our study was to elucidate the role of PKC isoforms in regulation of zymosan-induced lysosomal secretion.

MATERIALS AND METHODS

Materials

4-Methylumbelliferyl N-acetyl- β -D-glucosaminide (umb-NAG), wortmannin and zymosan were purchased from Sigma (St Louis, MO). PMA was from ICN (Costa Mesa, CA) and bafilomycin A₁ from Biomol (Plymouth Meeting, PA). GF 109203X was purchased from Calbiochem (La Jolla, CA). Rabbit polyclonal antibodies against PKC α and δ were purchased from Santa Cruz Biotechnology (Santa Cruz, CA). The monoclonal antibodies against PKC β and ϵ were from Transduction Labs (Lexington, KY).

Solutions

Na medium contained the following (in mM): NaCl, 127; KH₂PO₄, 1.2; KCl, 5.4; MgSO₄, 0.8; CaCl₂, 1.8; glucose, 5.6; 4-(2-hydroxyethyl)-1-piperazine-ethanesulfonic acid (HEPES), 10; and

pH was adjusted with NaOH to 7.2. Ca-free medium was identical with Na medium except the addition of 0.1 mM EGTA and absence of CaCl_2 . Ca-medium was made by adding 0.2 mM CaCl_2 to Ca-free medium.

Cell harvest and culture was performed as described earlier [12].

Measurements of lysosomal secretion

Cells were cultured in 12-welled culture dishes under conditions described above. After two washes with PBS cells were added 0.5 ml of experimental medium with or without pharmacological inhibitors dissolved in DMSO and incubated for 15 min. Zymosan 600 $\mu\text{g/ml}$ or bafilomycin A_1 1 μM was then added with or without addition of 100 nM PMA. The concentration of DMSO never exceeded 0.3%. After 60 min at 37°C stimulation was terminated on ice. When measuring time-course of zymosan-induced lysosomal secretion all cells were incubated in parallel for 60 min and stimuli added at appropriate time-points. Media were removed and isolated from non-adherent cells by 2 min centrifugations. Media were then added Triton X-100 to a concentration of 0.1%. Adherent cells were scraped using a rubber policeman in experimental medium containing 0.1% Triton. Lysosomal secretion was measured as release of N-acetyl- β -D-glucosaminidase compared to total content of the enzyme. The assay reaction was performed in 96-welled plastic dishes at room temperature. 140 μl sample was mixed with 210 μl substrate buffer containing 1.2 mM umb-NAG and 0.5 M citrate pH 4.5. Measurements were made every 3 min for 30 min in a Perkin-Elmer microplate reader with excitation and emission wavelengths set to 341 and 447 nm, respectively. The increase in fluorescence was linear with time and taken as a measure of the enzyme activity.

Electrophoresis, western blot analysis and semi-quantitative protein density measurements

Macrophages were cultured in 6-well plates with 1.5 million cells per well for 20 h. Cells were washed twice in PBS. Experiments were performed at 37°C and terminated on ice. Cells were again washed twice in PBS and then 2 wells were scraped in series in 400 μl buffer containing 80 mM KCl, 1 mM EDTA, 10 mM HEPES pH 7.4, 25 mM β -glycerophosphate, 10 mM NaF, 0.1 mM Na-orthovanadate, 2.5 mM DTE, 1 mM PMSF, 1 $\mu\text{g/ml}$ pepstatin and 5 $\mu\text{g/ml}$ leupeptin. After cell disruption using sonication with 20 pulses samples were centrifuged at 100000g for 60 min. Supernatants were added a 5 times concentrated laemmli's sample buffer while pellets were dissolved in laemmli's sample buffer to equal volumes. Samples were then boiled for 10 min, and subjected to sodium dodecyl sulfate (SDS)-

polyacrylamide gel electrophoresis according to the method of Laemmli [13], using 1.5-mm slab gels. Protein separation, transfer to membranes, detection PKC isoforms using specific antibodies and measurements of protein densities was performed as described previously [12].

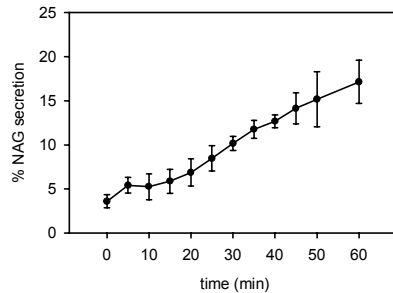

Fig. 1. Zymosan-induced lysosomal secretion in mouse macrophages. The plot shows lysosomal secretion presented as percentage of total cellular lysosomal content in non-stimulated macrophages and macrophages stimulated with 600 $\mu\text{g/ml}$ zymosan for 5 to 60 minutes in Na-medium at 37°C. Data are presented as mean \pm S.E.M. (n=3).

RESULTS

Translocation of PKC and induction of lysosomal secretion

When primary cultures of mouse macrophages were stimulated with zymosan, an increase in lysosomal secretion was detectable at 5 min and increased linearly up to 17.1 \pm 2.5% (SEM, n=3) at 60 min (figure 1). To investigate the role of PKC in onset and maintenance of zymosan-induced lysosomal secretion we analyzed the distribution of PKC isoforms between cytosol and membranes at different times of zymosan stimulation. Assessment of membrane translocation is widely used as an indicator of activation of PKC. A low membrane association of the isoforms α , β and δ was seen in non-stimulated cells (figure 2). PKC ϵ , on the other hand, was partly localized to membranes also in resting cells. The isoforms β , δ and ϵ behaved in a similar manner upon zymosan stimulation. Onset of translocation appeared within 5 minutes and the near maximal level, which was reached at 15 min of stimulation, was then maintained throughout the 60 min experimental period. PKC α behaved slightly differently. Less translocation compared to other isoforms occurred over the whole experimental period and in particular during the first 30 min of zymosan stimulation. Hence, translocation of isoforms β , δ and ϵ was detected at onset of zymosan-induced lysosomal secretion and remained translocated during the period of linear lysosomal secretion.

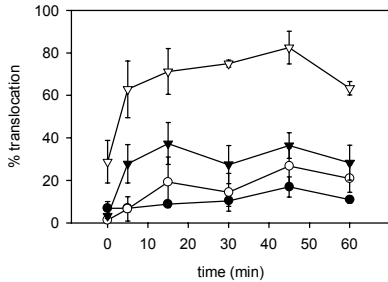

Fig. 2. Zymosan-induced membrane translocation of PKC. Symbols denote membrane translocation of PKC α (filled circles), β (open circles), δ (filled triangles) and ϵ (open triangles) in non-stimulated macrophages and macrophages stimulated with 600 $\mu\text{g}/\text{ml}$ zymosan for 5 to 60 minutes in Na-medium at 37°C. Data are presented as mean \pm S.E.M. (n=4 for isoforms α and δ and n=3 for β and ϵ).

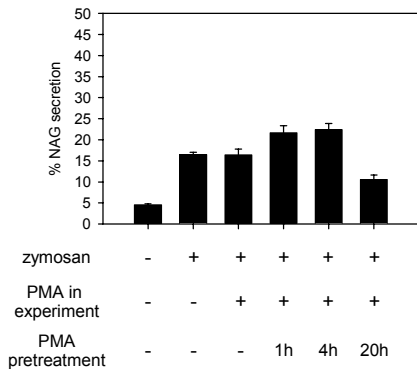

Fig. 3. Effects of PKC activation and down-regulation on lysosomal secretion. Bars show lysosomal secretion in non-stimulated macrophages and macrophages stimulated with 600 $\mu\text{g}/\text{ml}$ zymosan with or without addition of 100 nM PMA for 60 min at 37°C in Na-medium. In the three rightmost bars cells were pretreated with 100 nM PMA for 1, 4 and 20 h. Data are presented as mean \pm S.E.M. (n=30, 27, 10, 14, 19 and 13).

Effects of activation and down-regulation of PKC on lysosomal secretion

Interaction of zymosan beads with macrophages leads to alkalinization of lysosomes and this alkalinization is an important triggering signal for macrophage lysosomal secretion [4, 5]. In macrophages, secretion can be initiated by raising lysosomal pH either with lysosomotropic agents, ionophores or inhibitors of the lysosomal proton pump [5-7]. In our accompanying article we report that activation of PKC inhibited zymosan-

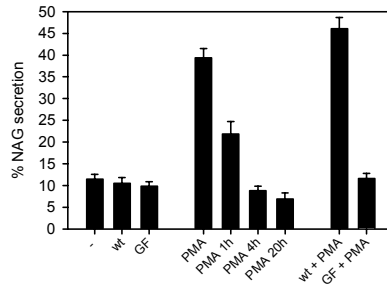

Fig. 4. Bafilomycin A₁-induced lysosomal secretion. All experiments were performed in Na-medium using 1 μM bafilomycin A₁ as stimulus for 60 min. Leftmost bars show cells without pretreatment (-) and cells pretreated for 15 min with 100 nM wortmannin (wt) or 1 μM GF109203X (GF). Middle bars show cells co-stimulated with 100 nM PMA and cells pretreated with 100 nM PMA for 1, 4 and 20 h prior to stimulation with PMA and bafilomycin A₁. Rightmost bars show cells pretreated for 15 min with 100 nM wortmannin or 1 μM GF109203X and then stimulated with 100 nM PMA in addition to bafilomycin A₁. Data are shown as mean \pm S.E.M. (n= 13, 5, 6, 8, 8, 8, 7, 3 and 5).

induced alkalinization of lysosomes [12]. Here we studied the involvement of PKC activation in signaling steps down-stream of lysosomal alkalinization and how this affected the secretory response. Lysosomal secretion was studied in cells stimulated with the phorbol ester PMA. PMA is a potent and rapid activator of conventional and novel isoforms of PKC [10]. Treatment with 100 nM PMA in addition to zymosan for 15 min caused a near complete membrane translocation of all studied isoforms (figure 6). Prolonged stimulation resulted in differential down-regulation and disappearance first of conventional and then novel isoforms [12]. Simultaneous addition of PMA with zymosan did not alter the secretory response seen with zymosan alone (figure 3). After 1 to 4 h of treatment with PMA an increase in zymosan-induced lysosomal secretion was observed. This increase was then reversed after 20 h of PMA-mediated down-regulation of PKC. These complex effects of PMA on lysosomal secretion could be due to activation of PKC as well as termination of PKC-mediated signaling due to down-regulation and indicate the existence of multiple targets in PKC-mediated modulation of lysosomal secretion. As lysosomal alkalinization is an important triggering event in macrophage secretion, further experiments were performed to investigate the role of lysosomal pH as a target in PMA-induced modulation of lysosomal secretion and thereby to clarify possible down-stream targets of PMA on late steps in the secretory process.

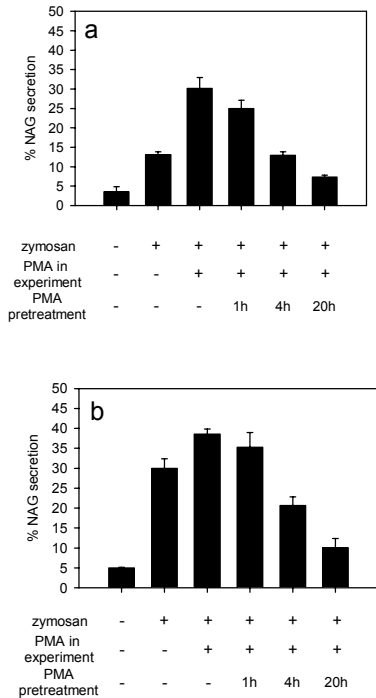

Fig. 5. Effects on zymosan-induced lysosomal secretion by inhibition of PI3K and PKC. Bars show lysosomal secretion in macrophages. Experimental setup was the same as in figure 3 except that the cells were pretreated prior to stimulation with either 100 nM wortmannin (a) or 1 μ M GF109203X (b) for 15 min in experimental media at 37°C. Data are shown as mean \pm S.E.M. (n= 3, 12, 5, 7, 8, 6 in a and n= 3, 7, 4, 3, 3, 3 in b).

Effects of PKC-activation on late steps in the secretory pathway

In macrophages, Bafilomycin A₁ is a non-particulate trigger of lysosomal secretion acting through binding and inhibiting the lysosomal proton pump which results in alkalinization [7]. Lysosomal secretion is thus triggered under circumstances where signaling events leading to lysosomal alkalinization are bypassed. In our hands treatment with 1 μ M bafilomycin A₁ for 60 min stimulated secretion of 11.5 \pm 1.1% (SEM, n=13) of total lysosomal enzyme content. Non-stimulated cells secreted 4.57 \pm 0.24% (SEM, n=31) of their total lysosomal enzyme content. Bafilomycin A₁-induced secretion was greatly enhanced by PMA-induced activation of PKC (figure 4). As PKC isoforms were disappeared. No enhancement of secretion down-regulated, this enhancement of secretion remained

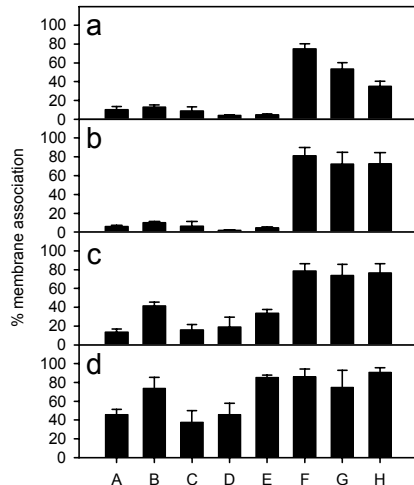

Fig. 6. Effects of wortmannin and Ca²⁺-depletion on translocation of PKC. The figure shows membrane translocation of PKC α (a), β (b), δ (c) and ϵ (d) in macrophages. The two leftmost bars show translocation in non-stimulated cells (A) and in cells stimulated with 600 μ g/ml zymosan for 15 min (B). Bar C shows cells treated with 1 μ M A23187 in Ca-medium for 15 min. Bars D, E and H show cells depleted of Ca²⁺ by 15 min pretreatment in Ca-free medium with addition of 1 μ M A23187. Cells in E were stimulated with 600 μ g/ml zymosan for 15 min while cells in F, G and H were stimulated with both 600 μ g/ml zymosan and 100 nM PMA for 15 min. Cells in F were stimulated with both 600 μ g/ml zymosan and 100 nM PMA for 15 min in Na-medium. Cells in G were pretreated for 15 min with 100 nM wortmannin prior to stimulation. Data are presented as mean \pm S.E.M. and experiments were performed at least 3 times.

after 4 h of treatment with 100 nM PMA. The effect of PMA on the secretory machinery downstream of lysosomal alkalinization was inhibited by 15 min pretreatment with 1 μ M GF109203X but not with 100 nM wortmannin. Neither wortmannin nor GF109203X significantly inhibited lysosomal secretion induced by bafilomycin A₁ alone.

The role of lysosomal pH in PKC-mediated modulation of lysosomal secretion

As seen in bafilomycin A₁-treated cells, a great enhancement of zymosan-induced lysosomal secretion by PMA could be expected. Instead, zymosan-induced lysosomal secretion was initially not affected by PMA-induced PKC activation. This was probably due to the inhibiting effect of PMA on lysosomal alkalinization identified in our accompanying article [12]. A reduction of lysosomal pH could counteract and mask effects of PKC-activation on late steps in the secretory machinery. This conclusion was indeed supported

by the finding that pre-treatment with wortmannin which reversed PMA-induced effects on lysosomal alkalization also unmasked the enhancement of zymosan-induced lysosomal secretion caused by PMA (figure 5 a). When the effects of PMA-treatment on lysosomal pH was prevented by wortmannin, the PMA-induced enhancement of zymosan-induced lysosomal secretion was down-regulated by PMA in a pattern very much resembling that seen with bafilomycin A₁ as stimulus (figure 5 a cf 4). Prevention of PKC-activation by a 15 min pretreatment with 1 μ M GF109203 was in the accompanying article found to enhance zymosan-induced lysosomal alkalization. These conditions also enhanced lysosomal secretion further stressing the importance of lysosomal pH in macrophage lysosomal secretion (figure 5 b).

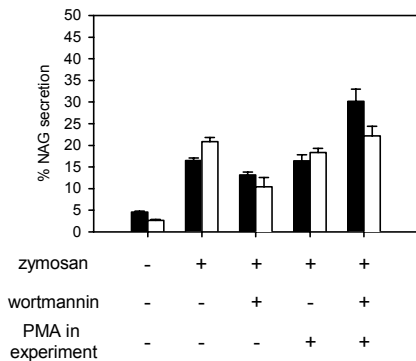

Fig. 7. Effects of cytosolic Ca²⁺ on lysosomal secretion. Filled bars denote cells stimulated in Na-medium and open bars denote cells pretreated for 15 min and stimulated in Ca-free medium containing 1 μ M A23187. 100 nM wortmannin was present for 15 min prior to stimulation in the middle bars and the rightmost bars. Cells were stimulated with 600 μ g/ml zymosan with or without 100 nM PMA for 60 min. Data are presented as mean \pm S.E.M. for cells stimulated in Na-medium (n= 31, 28, 12, 12 and 5) and cells stimulated in Ca-free medium (n= 4, 11, 4, 5 and 4).

The role of Ca²⁺ in PKC-mediated modulation of lysosomal secretion

Since the effects of PMA were transient resembling the down-regulatory pattern of conventional isoforms of PKC we studied lysosomal pH and secretion under conditions where cells were depleted of Ca²⁺. Novel isoforms are activated by cellular production of DG while conventional isoforms are also sensitive to cytosolic Ca²⁺. Initially we analyzed the effect of Ca²⁺ depletion on the activation of PKC in mouse macrophages. Activation of PKC was assessed by measuring its translocation to the membrane

fraction. Ca²⁺ was depleted using a Ca²⁺-free Na-medium supplemented with 0.1 mM EGTA. Addition of 1 μ M of the ionophore A23187 allowed free passage of Ca²⁺ out of the cells. This condition clearly reduced the membrane association of the conventional isoforms α and β with or without stimulation with zymosan (figure 6). A lesser effect was found on the novel isoforms δ and ϵ . PMA induced a near total translocation of all isoforms studied. Surprisingly, PMA-induced translocation of PKC α alone was partly sensitive to cellular depletion of Ca²⁺. To certify that our Ca²⁺-depletion procedure did not cause an initial intracellular Ca²⁺ peak that would affect localization of PKC we artificially elevated intracellular calcium by adding 1 μ M A23187 for 15 min to cells kept in a Ca²⁺-containing medium. In contrast to Ca²⁺ depletion this condition caused a low translocation of conventional isoforms of PKC (figure 6).

As shown in our accompanying article depletion of Ca²⁺ resulted in an enhancement of zymosan-induced lysosomal alkalization [12]. Here we show a resulting increase in lysosomal secretion under these conditions (figure 7). The increase in secretion was small compared to the effect on lysosomal pH suggesting additional Ca²⁺-sensitive modulators acting downstream of the triggered lysosomal alkalization. This was even more evident in cells co-stimulated with PMA where Ca²⁺-depletion abolished PMA-induced diminution of lysosomal alkalization. This effect of Ca²⁺-depletion was not followed by an enhancement of lysosomal secretion. Evidently, depletion of Ca²⁺ could prevent PMA-induced effects both on lysosomal pH and on downstream enhancement of lysosomal secretion. In figure 8, a scheme is presented summarizing the findings in the present and the accompanying article.

DISCUSSION

The macrophage lysosomal secretory response is in several regards unique in comparison to regulated secretion in other cell-types. This is interestingly true also for cells of common hematopoietic lineage. For instance is degranulation in neutrophils [14], release of histamine from basophils and mast cells [15] and platelet granule exocytosis [16] sensitive to modulation of Ca²⁺. Degranulation in these cells is furthermore triggered in response to an elevation of cytosolic Ca²⁺. Elevation of calcium by entry into cells upon injury has recently gained focus as a triggering signal of lysosomal secretion with the purpose of self-healing the plasma membrane [3]. Lysosomal secretion may thus be common to a broader spectrum of cell-types including epithelial cells and fibroblasts. In macrophages, on the other hand, several reports point out lysosomal secretion as a process not dependent on intracellular Ca²⁺ and elevation of intracellular Ca²⁺ through treatment with Ca²⁺ ionophores does not evoke

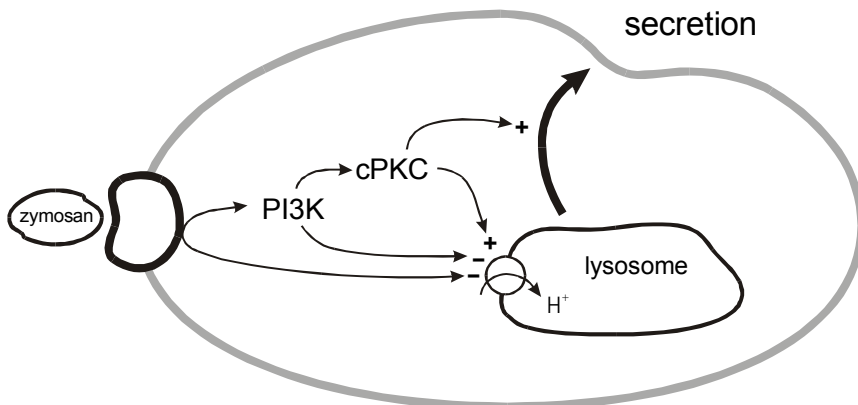

Fig. 8. Schematic view of plausible signaling pathways involved in PKC-mediated modulation of lysosomal secretion

lysosomal secretion [4]. Ca^{2+} triggers degranulation in excitatory cells through opening of plasma membrane-localized voltage-gated Ca^{2+} channels and it is possible that the usage of Ca^{2+} as a trigger of degranulation in inflammatory cells is restricted to cells expressing the corresponding store-operated Ca^{2+} channel found in HL60 cells [17]. The lack of dependency on Ca^{2+} in macrophages is surprising since several proteins involved in vesicle recognition and fusion are regulated by or dependent on Ca^{2+} [18]. While lacking the machinery for Ca^{2+} -induced degranulation, alkalization of lysosomal pH seems to be an important triggering step in signaling to lysosomal secretion in macrophages. Correlation between lysosomal alkalization and secretion has been shown using methylamine and chloroquine [6], monensin and nigericin [4] and bafilomycin A_1 [7]. Macrophages respond also to particulate stimuli with a rise in lysosomal pH. This response is dependent on receptor-mediated signaling and not a result of phagolysosomal fusion since phagocytosis of latex beads fails to evoke lysosomal alkalization [4]. We show in the accompanying article that treatment of macrophages with concentrations of cytochalasin B that cause a total prevention of zymosan phagocytosis does not reduce lysosomal alkalization which further supports an involvement of signaling in zymosan-induced lysosomal alkalization [12]. In addition to a triggering function of lysosomal alkalization a correlation between the magnitude of zymosan-induced alkalization and the secretory response can be noted when comparing results in the present and the accompanying study. For instance, pretreatment with wortmannin slightly lowered

zymosan-induced lysosomal alkalization and the resulting secretion while Ca^{2+} depletion and GF109203X increased zymosan-induced lysosomal alkalization and secretion. However, it should be noted that treatment with bafilomycin A_1 alone, which is believed to act solely through inhibition of the H^+ -ATPase causing a lysosomal alkalization larger than that seen after zymosan-treatment [19], resulted in a comparably low secretion. This might be explained by the fact that bafilomycin A_1 lowers macrophage cytosolic pH [12] which is known to negatively modulate lysosomal secretion [5]. A more likely explanation is that signaling pathways activated by zymosan treatment also enhance secretion at steps downstream of the elevation of lysosomal pH. Bafilomycin A_1 became a very potent secretagogue in synergism with PMA-induced activation of PKC. It is well known that zymosan-treatment of macrophages results in a phosphoinositide response, intracellular elevation of Ca^{2+} and production of DG [20-22] which are activators of PKC.

We could here confirm the expression in macrophages of the conventional PKC isoforms α and β and the novel isoforms δ and ϵ as described earlier [8, 9]. PKC ζ is sensitive to neither cellular DG nor treatment with PMA and was not investigated in this study. Zymosan-induced lysosomal secretion was found to be linear with time and measurable within 5 min. A parallel analysis of the PKC isoforms also revealed increased membrane translocation within this time indicative of activation. Whether this activation preceded the initiation of secretion could not be determined. It can be noted that a partial translocation of isoforms δ and ϵ was found in

resting macrophages as described in other cell-types [23]. Membrane translocation of PKC is widely used as a measure of its activation [24].

The literature on PKC-involvement in degranulation is comprehensive including studies performed on cells of neuronal, digestive tract, endocrine and haematopoietic origin. A potential role of PKC in degranulative responses in inflammatory cells has been shown using phorbol ester-induced activation and down-regulation, depletion through leakage of PKC in permeabilized cells and through the use of pharmacological inhibitors. Treatment of cells with PMA alone can cause histamine release from basophils [25], specific granule exocytosis in neutrophils [26] but neither azurophilic granule exocytosis in neutrophils [26] nor lysosomal secretion in macrophages [4]. In RBL-2H3 mast and basophilic cells, involvement of PKC in degranulation has been reported with an apparent promoting role of PKC β [27, 28]. Others have shown that degranulation can occur independently of PKC in neutrophils [14, 26].

In this study we show that PMA treatment exerts a complex effect on zymosan-induced lysosomal secretion in mouse macrophages. Secretion was at first unaffected, elevated at 1 to 4 h of PMA-pretreatment and then diminished after 20 h of PMA-pretreatment. A possible explanation for these effects could be found in the differential down-regulation of specific isoforms of PKC. The existence of two isoforms with promoting and inhibiting functions, respectively, in secretion would at first leave the secretion unaffected by PMA-treatment. A differential down-regulation with disappearance first of the inhibiting and then the promoting isoform could result in a pattern of the type found in zymosan-induced lysosomal secretion. This explanation is not plausible since Bafilomycin A₁-induced lysosomal secretion was greatly increased by co-stimulation with PMA. This elevation was reduced after 1 h of PMA-pretreatment and totally abolished after longer pretreatments. The explanation for the differential effect of activation and down-regulation of PKC found on secretion triggered by these two stimuli, both acting through elevation of lysosomal pH, is instead found in PMA-induced modulations of zymosan-triggered lysosomal alkalization. As shown in the accompanying article, PMA treatment initially reduces zymosan-induced lysosomal alkalization. This could initially balance the stimulating effect of PMA seen on bafilomycin A₁-induced secretion causing the more complex pattern seen in zymosan-induced secretion. Effects of PMA on bafilomycin A₁-induced lysosomal alkalization were not investigated but are not likely since signaling steps are bypassed by this agent which acts directly on the acidifying vacuolar H⁺-ATPase. The normalization seen in bafilomycin A₁-induced secretion after longer times of PMA-treatment coincided with the down-regulation of conventional PKC isoforms identified in the

accompanying article. Secretion was normalized after 4 h of PMA treatment. Again, a discrepancy could be noted in comparison to zymosan-induced secretion. This discrepancy could again be explained by the fact that lysosomal pH was slightly increased after 4 h of PMA-treatment. The assumption that the complex pattern of zymosan-induced secretion seen during down-regulation of PKC is due to dual effects on lysosomal pH and on downstream targets in the secretory process is supported by the fact that wortmannin which inhibits effects of PMA on lysosomal pH causes a secretory pattern identical to that seen with bafilomycin A₁.

The downstream effect of PMA on zymosan-induced secretion was partly dependent on intracellular Ca²⁺ since depletion of Ca²⁺ abrogated the effect of PMA on lysosomal pH which should unmask an enhancing effect of PMA on secretion. This was not the case, however, thus indicating the necessity for Ca²⁺ in PMA-induced activation of PKC. Synergism between Ca²⁺ and phorbol esters has been described in translocation and activation of conventional isoforms of PKC [29]. Interestingly, we found that only PMA-induced translocation of the conventional isoform α was partly sensitive to cellular depletion of Ca²⁺. A role for PI3K in PMA-induced regulation of lysosomal pH and translocation of PKC to lysosomes was identified [12]. In the present study we show that inhibition of PI3K by wortmannin did not prevent translocation of PKC isoforms to a total membrane fraction nor was PMA-induced enhancement of bafilomycin A₁-triggered secretion blocked by wortmannin.

PKC substrates responsible for PMA-induced enhancement of lysosomal secretion remain to be identified. It has for instance been shown that enhanced degranulation by activation of PKC in excitable cells is due to an increased number of vesicles in the readily releasable pool [30, 31]. The readily releasable pool is thought to represent a primed state often involving a minority of the total number of cellular vesicles. These vesicles are docked at the plasma membrane awaiting a triggering signal. Several signaling molecules, cytoskeletal and motor proteins as well as members of the fusion complex are involved in inflammatory cell degranulation and are regulated by PKC and thus potential targets in PMA-induced enhancement of lysosomal secretion in macrophages. A role for phospholipase D (PLD) in HL60 cell degranulation has been demonstrated [32]. PKC is a known regulator of PLD together with ARF and Rho proteins [33]. Lysosomes associate with the motor proteins dynein and kinesin of which the latter has been shown to mediate radial movement along microtubules in macrophages [34, 35]. Organelle-association with kinesin can be regulated by phosphorylation [36, 37]. Syntaxin 4 is a member of the SNARE fusion proteins and is involved in lysosomal exocytosis in

platelets and its protein interactions can be regulated in a PKC-dependent manner [38].

Lately, an increasing number of reports have been presented ascribing cellular functions to specific isoforms of PKC. In HL60 cells, for example, a role for PKC β was proposed in the regulation of the respiratory burst [39]. With increased insight into the functional specialization among PKC isoforms and into their tissue-specific expression a new field for therapeutic intervention may well open up.

Acknowledgements

We thank Pia Lundquist for excellent technical. This work was supported by a grant from the Swedish Medical Research Council (Project 5410), The Albert Pahlsson Foundation, King Gustav V's 80-year foundation, The Greta and Johan Kock Foundation, The Royal Physiographic Society, The Crafoord Foundation and the Albert Österlund Foundation.

REFERENCES

- [1] P. Davies, R.J. Bonney, (1980) in *The Cell Biology of Inflammation*, vol. 2 (G. Weissmann, ed.), pp. 497-542, Elsevier, Amsterdam.
- [2] J.I. Gallin, I.M. Goldstein, R. Snyderman, (1992) *Inflammation. Basic principles and clinical correlates*, Raven Press, N.Y.
- [3] N.W. Andrews, *Trends Cell Biol.* **10** (2000) 316-321.
- [4] H. Tapper, R. Sundler, *J. Leukoc. Biol.* **58** (1995) 485-494.
- [5] H. Tapper, R. Sundler, *Biochem. J.* **272** (1990) 407-414.
- [6] D.W. Riches, D.R. Stanworth, *Biochem. J.* **202** (1982) 639-45.
- [7] H. Tapper, R. Sundler, *J. Cell Physiol.* **163** (1995) 137-144.
- [8] A. Huwiler, J. Pfeilschifter, *Eur. J. Biochem.* **217** (1993) 69-75.
- [9] M.M. Monick, A.B. Carter, G. Gudmundsson, L.J. Geist, G.W. Hunninghake, *Am. J. Physiol.* **275** (1998) L389-L397.
- [10] A.C. Newton, *Curr. Opin. Cell Biol.* **9** (1997) 161-167.
- [11] K. Nishikawa, A. Toker, F.-J. Johannes, Z. Songyang, L.C. Cantley, *J. Biol. Chem.* **272** (1997) 952-960.
- [12] C. Naucler, R. Sundler, Regulation of lysosomal pH in macrophages via phosphatidylinositol 3-kinase and protein kinase C.
- [13] U.K. Laemmli, *Nature* **227** (1970) 680-685.
- [14] H.W.M. Niessen, A.J. Verhoeven, *Biochim. Biophys. Acta* **1223** (1994) 267-273.
- [15] T.M. Cunniffe, F.L. Pearce, *Agents Actions* **23** (1988) 170-172.
- [16] P.J. Padfield, N. Panesar, P. Henderson, J.J. Baldassare, *Biochem. J.* **314** (1996) 123-8.
- [17] O. Nusse, L. Serrander, R. Foyouzi-Youssefi, A. Monod, D.P. Lew, K.H. Krause, *J. Biol. Chem.* **272** (1997) 28360-7.
- [18] T.C. Sudhof, *Nature* **375** (1995) 645-653.
- [19] K. Gewert, H. Tapper, C. Naucler, R. Sundler, *J. Inflamm.* **47** (1995) 115-125.
- [20] M.J. Berridge, *Nature* **361** (1993) 315-25.
- [21] A. Emilsson, R. Sundler, *J. Biol. Chem.* **259** (1984) 3111-6.
- [22] P. Dieter, E. Fitzke, *Eur. J. Biochem.* **218** (1993) 753-758.
- [23] K. Miura, D.W.J. MacGlashan, *Blood* **92** (1998) 1206-1218.
- [24] H. Hug, T.F. Sarre, *Biochem. J.* **291** (1993) 329-43.
- [25] H. Bergstrand, B. Lundquist, P. Michelsen, *Eur. J. Haematol.* **41** (1988) 467-77.
- [26] J.E. Merritt, J.A. Sullivan, J. Tse, S. Wilkinson, J.S. Nixon, *Cell. Signal.* **9** (1997) 53-7.
- [27] K. Ozawa, Z. Szallasi, M.G. Kazanietz, P.M. Blumberg, H. Mischak, J.F. Mushinski, M.A. Beaven, *J. Biol. Chem.* **268** (1993) 1749-56.
- [28] E.Y. Chang, Z. Szallasi, P. Acs, V. Raizada, P.C. Wolfe, C. Fewtrell, P.M. Blumberg, J. Rivera, *J. Immunol.* **159** (1997) 2624-32.
- [29] M. Wolf, H.d. LeVine, W.S.J. May, P. Cuatrecasas, N. Sahyoun, *Nature* **317** (1985) 546-549.
- [30] C.F. Stevens, J.M. Sullivan, *Neuron* **21** (1998) 885-93.
- [31] K.D. Gillis, R. Mössner, E. Neher, *Neuron* **16** (1996) 1209-20.
- [32] J. Stutchfield, S. Cockcroft, *Biochem. J.* **293** (1993) 649-55.
- [33] S.M. Hammond, J.M. Jenco, S. Nakashima, K. Cadwallar, Q.-M. Gu, S. Cook, Y. Nozawa, G.D. Prestwich, M.A. Frohman, A.J. Morris, *J. Biol. Chem.* **272** (1997) 3860-3868.
- [34] P.J. Hollenbeck, J.A. Swanson, *Nature* **346** (1990) 864-6.
- [35] S.X. Lin, C.A. Collins, *J. Cell Sci.* **101** (1992) 125-137.
- [36] K.D. Lee, P.J. Hollenbeck, *J. Biol. Chem.* **270** (1995) 5600-5605.
- [37] R. Sato-Yoshitake, H. Yorifuji, M. Inagaki, N. Hirokawa, *J. Biol. Chem.* **267** (1992) 23930-6.
- [38] G.L. Reed, A.K. Houg, M.L. Fitzgerald, *Blood* **93** (1999) 2617-26.
- [39] H.M. Korchak, M.W. Rossi, L.E. Kilpatrick, *J. Biol. Chem.* **273** (1998) 27292-9.