



LUND UNIVERSITY

The Useworthiness of Robots for People with Physical Disabilities

Eftring, Håkan

1999

[Link to publication](#)

Citation for published version (APA):

Eftring, H. (1999). *The Useworthiness of Robots for People with Physical Disabilities*. [Doctoral Thesis (monograph), Certec - Rehabilitation Engineering and Design]. Certec, Lund University.

Total number of authors:

1

General rights

Unless other specific re-use rights are stated the following general rights apply:

Copyright and moral rights for the publications made accessible in the public portal are retained by the authors and/or other copyright owners and it is a condition of accessing publications that users recognise and abide by the legal requirements associated with these rights.

- Users may download and print one copy of any publication from the public portal for the purpose of private study or research.
- You may not further distribute the material or use it for any profit-making activity or commercial gain
- You may freely distribute the URL identifying the publication in the public portal

Read more about Creative commons licenses: <https://creativecommons.org/licenses/>

Take down policy

If you believe that this document breaches copyright please contact us providing details, and we will remove access to the work immediately and investigate your claim.

LUND UNIVERSITY

PO Box 117
221 00 Lund
+46 46-222 00 00



DOCTORAL DISSERTATION CERTEC, LTH NUMBER 1:1999

Håkan Eftring



**The Useworthiness of
Robots for
People with
Physical Disabilities**



Department of Design Sciences
Lund University

To Ann

The photograph on the front cover shows Eva Gerdén using the wheelchair-mounted Manus manipulator for making coffee.

Photo: Ulrika Lindström

Acknowledgements

Above all, I wish to thank *my wife Ann*, for being there, for being who you are, for supporting me in my work on this dissertation, for all the work you have done in connection with our move to our new house which happened to coincide with the final stage of the writing of this dissertation, and for taking care of our two horses Afrodite and Symphatie during this time. I love you.

I also wish to express my sincere gratitude to *my supervisor Professor Bodil Jönsson*, for urging me on during the completion of this thesis, for supporting me in my writing, for helping me raise the scientific quality of the thesis and for being a driving force in the ensuring that Rehabilitation Engineering was given official status as a graduate research subject.

I also thank *my former supervisor Professor Gunnar Bolmsjö* of the Division of Robotics, for his work during the RAID projects, for sharing his knowledge of robotics, for his interest in service robots, and for helping me lay the foundations of this thesis.

I would like to thank my colleague *Henrik Danielsson* for providing invaluable help during the final stage of my work on this thesis. Thank you for helping me structure large parts of the contents, for pulling the words out of me when I got stuck, and for helping me with pictures, tables, and layout work.

I wish to express my sincere thanks to *Anna-Karin Batcheller* for translating the thesis from Swedish into English and for correcting the grossest errors in the parts of the text that I wrote in English. I am also grateful for having the opportunity to write in Swedish. This has made the thesis richer in variety of expression.

Other people who have helped me in the final stages of my work on this thesis and whom I wish to thank are *Lena Leveen*, who has proofread the text and helped me with administrative work and the list of references, *Karin Rehman* for providing layout templates and layout suggestions and *Christofer Gustafsson* for helping me with pictures and for publishing video sequences of the page turning movements on the Internet.

I also thank *Eva Almberg* (née Gerdén), *Christer Evaldsson*, and all the RAID and Manus test users for participating in user trials and for contributing many valuable comments. I would not have been able to complete this thesis without your participation.

I thank *Bengt Sjölund* and *Kerstin Boschian* of the Department of Rehabilitation at Lund University Hospital for their work on the RAID and Manus projects. I also wish to thank the other participants in these projects, including *Tim Jones* and *Colin Upton*, Oxford Intelligent Machines Ltd, England, *John Dallaway*, Cambridge University Engineering Department, England, *Patrick*

Finlay, Armstrong Projects Ltd, England, *Riadh Cammoun* and *Françoise Lauture*, CEA, France, *Charlotte Granvik* and *Lars Rauer*, AmuGruppen Hadar AB, Sweden, *EvaKarin Einarsson*, *Håkan Jönsson*, *Helena Holmqvist*, *Jessica Jönsson* and *Lillemor Fritzson*, Department of Rehabilitation at Lund University Hospital, Sweden, and *Hans Evers*, Exact Dynamics bv, Holland.

The financial support provided by NUTEK (Swedish National Board for Industrial and Technical Development), the European Union TIDE research program, Stiftelsen för bistånd åt rörelsehindrade i Skåne, The National Board of Health and Welfare, and Region Skåne is gratefully acknowledged.

Finally, I thank all my colleagues at Certec for taking on an extra workload to enable me to focus on this thesis. I am especially grateful to *Jonas Falkvall*. My colleagues have also greatly contributed to the inspiring and creative environment in which I have carried out my work on this thesis. I would especially like to thank *Arne Svensk*, *Charlotte Magnusson*, *Gunilla Knall* and my “robot friend” *Håkan Neveryd* for many fruitful discussions. I am also very grateful that I had the chance to get to know and work with the late *Ingvar Jönsson*. He provided invaluable help with the development of page turning grippers and his presence can still be felt at Certec. Thank you, Ingvar.

Lund, August 1999

Håkan Efttring

Abstract

This thesis deals with robotics and the new possibilities it offers people with physical disabilities. I focus on the user and the use of the technology and, in particular, on what makes robotic aids worth using – useworthiness as distinguished from usability.

User experience of the wheelchair-mounted Manus manipulator shows that robotic arms must meet technical requirements in terms of acceleration, speed, and pattern of movement. Easy horizontal and vertical adjustment of the end-effector is another requirement which must be met to enable a user to carry out the most common movements faster with less concentration.

Experience of the useworthiness of robots was first obtained through the development of page-turning end-effectors for the RAID workstation. The principles of separating pages and the page-turning movements are analyzed and described in this thesis. End-effectors are essential to the functionality and useworthiness of robots. The performance requirements for the automatic grasping function for simplified robot use have been brought out through user trials.

The thesis demonstrates that user trials with robots as assistive devices can result in new knowledge about both the use of the technology itself and the personal characteristics – needs, abilities, wishes, and dreams – of the user.

Parts of the thesis have already been published or will be published in the form of articles and conference papers:

- *Robotics in rehabilitation*. IEEE Transactions on Rehabilitation Engineering, vol. 3, no 1, pp. 77-83, March 1995.
- *The Manus Manipulator as a Tool for Rehabilitation*. To be published in the Scandinavian Journal of Rehabilitation Medicine.
- *Technical results from Manus user trials*. Proceedings of the sixth International Conference on Rehabilitation Robotics (ICORR), pp. 136-141, Stanford, California, USA, July 1999.
- *Robot control methods and results from user trials on the RAID workstation*. Proceedings of the fourth International Conference on Rehabilitation Robotics (ICORR), pp. 97-101, Wilmington, Delaware, USA, June 1994.
- *RAID – A Robotic Workstation for the Disabled*. Proceedings of the 2nd European Conference on the Advancement of Rehabilitation Technology (ECART 2), pp. 24.3, Stockholm, Sweden, May 1993.

Keywords:

Rehabilitation Robotics, Robots, Physical Disabilities, Usability, Useworthiness, End-effector, Page-turning, RAID, Manus, Independence, Needs Analysis, Simplified Robot Use, Automatic Grasping, Ethics, Case Studies.

Table of Contents

1 Introduction	7
1.1 Searching User Requirements	7
1.2 Statistical Needs Analysis	8
1.3 Two Main Robot Categories	9
1.4 Useworthiness	10
1.5 Certec as a Platform	11
1.6 Thesis Outline	12
1.7 Primary Contributions	13
2 Rehabilitation Robotics	15
2.1 Sources	15
2.2 Survey Papers	16
2.3 Needs and Utility	17
2.4 Rehabilitation Robots	17
3 Useworthiness	23
3.1 The Purpose of the Concept of Useworthiness	23
3.2 Definitions of Usability	23
3.3 Definition of Useworthiness	25
3.4 The Useworthiness of Robots	27
4 Development of the RAID Workstation	29
4.1 The RAID and EPI-RAID Projects	29
4.2 My Participation in the Projects	31
4.3 RAID – A Robotic Workstation for the Disabled	32
4.4 Robotics in Rehabilitation	37
4.5 Specification of Robot Tasks	50
4.6 Page-turning Developments	52
4.7 Robot Control Methods and Results from User Trials on the RAID Workstation	76
5 User Trials of the Manus Manipulator	83
5.1 The Manus Manipulator as a Tool for Rehabilitation	83
5.2 Technical Results from Manus User Trials	99
6 In-depth Interview with a Manus User	105
6.1 Why Is “Useworthy” a Good Concept?	105
6.2 Assistive Devices	106
6.3 Having the Initiative	108
6.4 The Manus Manipulator – a Step Towards Independence	110
6.5 Assistance Burn-out	111
6.6 What Does the Term “Useworthy” Imply?	114
6.7 Using the Manus Manipulator – Three Decisions	120
6.8 What Do Other People Think of the Manus Manipulator?	121

7 Simplified Use of Directly Controlled Robots	123
7.1 Difficulties of Using the Manus Manipulator	124
7.2 Common Tasks and the Movements of the Robot when Carrying Out these Tasks	127
7.3 Common Objects	128
7.4 Examples of Simplified Robot Use	129
7.5 Analysis of Simplifications	131
8 Ethical Issues	135
8.1 Rehabilitation Engineering Research Ethics	135
8.2 Ethical Problems Associated with the Use of Robots	136
8.3 Physical Risks	137
9 Discussion and Conclusions	141
9.1 Surprising Findings	145
9.2 Conclusions	146
9.3 Looking Ahead	147
References	149
Appendix A, Reliability of RAID1 Tasks	163
Appendix B, Reliability of RAID1A Tasks	171
Appendix C, Manus Arm Questionnaire	175
Appendix D, Safety Considerations of Manus	181

1 Introduction

1.1 Searching User Requirements

During the whole time I have been working with robots as assistive devices for people with physical disabilities, i.e. 1992-1999, I have been striving to increase the functionality and usability of robots. I have been inspired by the thought that most important thing is for people with physical disabilities to increase their knowledge about the possibilities of robotics. This will enable them to specify their own requirements for what robots should look like and how they should work in order to be good assistive devices. If robotic devices were shown to be usable for some people, this would create a positive spiral, making robotic devices usable for other people as well.

The fact that I have an engineering background and that parts of my research have been purely technical has been an essential prerequisite in my work aimed at increasing the functionality and usability of robots. Because, unfortunately, robotic devices for people with physical disabilities often require extensive modifications which are specific to each individual. The fact that one small detail does not work is enough to make the robot unusable. Reliability is another critical factor, as is flexibility. In principle, the flexibility of the robot is endless, but choices must be made in order to make it functional.

Research on robots for people with physical disabilities can be viewed as a special area within design research. As is almost always the case in the field of design, there are few opportunities for beginning a project on the basis of definite requirement specifications and, moreover, finding out what people with physical disabilities require of a robotic device presents obvious difficulties. One reason for this is that it is difficult to have an opinion about something that one does not know a great deal about. The answer to the question "What do you want?" is often "What can I get?"

"What do you want?"

"What can I get?"

Often, the researcher/designer must instead construct problem descriptions based on the specific situation. In order to give the user a first look at what is possible, he is presented with an initial technical concept. It is then possible to move on to a discussion based on this concept and subsequent variants (Jönsson and Anderberg, 1999). The robot user, the robot, and the overall

situation (including other assistance, for example) must, in the words of Donald Schön (Schön, 1983), be allowed to “talk back”.

Accordingly, the process begins with something which is best described as an educated guess. The metaphors the researcher gradually acquires are invaluable when it comes to making such a guess – in the words of Donald Schön (Schön, 1983): “seeing as ...” – and, looking back, I believe that I have improved my ability to find constructive and useful analogies when faced with a seemingly new user situation.

An iterative process

Once the user has been shown a first concrete technical solution and has provided feedback on it, an iterative process can begin. In this process, not only does the technology improve, but we also gain better insight into the needs, abilities, wishes, and dreams of the user. The scientist and the user converge because they are both able to focus on the technology itself and to some extent use the technology as a language. It becomes possible to challenge the user’s ingrained ways of thinking, and having a wide range of functionality to choose from may increase the user’s awareness of what he really finds worth using.

1.2 Statistical Needs Analysis

A demographic survey carried out in the United States (Stanger and Cawley, 1996) identifies the diagnosis groups which would benefit from using a robot. These include people with a spinal cord injury, muscular dystrophy (MD), spinal muscular atrophy (SMA), multiple sclerosis (MS), amyotrophic lateral sclerosis (ALS), cerebral palsy (CP), rheumatoid arthritis (RA), and polio. It is difficult to estimate how many from these groups would find a robot useful since the degree of impairment to the hands and arms is rarely indicated in statistical data about people with disabilities. In addition, some people with physical disabilities also have cognitive impairments which may make it difficult to use a robot. The number of individuals in the United States who could benefit from using a robot is estimated at 150,000 at most, i.e. 0.06 % of the population. In Sweden, the same percentage would correspond to approximately 5000 individuals.

However, while 5000 Swedes are potential robot users, at present there are only about 150 users of various types of robots as assistive devices worldwide (Mahoney, 1997). There are a number of reasons for this: lack of information, organizational problems, technical problems, and lack of knowledge and experience as to how robotic devices can be used.

The technology is relatively unknown not only among people with physical disabilities and their relatives, but also among those who are active in medical and professional rehabilitation, and at

technical aid centers and social insurance offices. These groups have limited knowledge and experience of existing robot installations and robot users. Even if someone gets the idea or finds out that a robot could be a suitable assistive device, it is not obvious what the next step is in turning the possibility into reality. The cost (SEK 250,000 – 500,000, i.e. \$30,000 – 60,000) also means that the social insurance office or the municipality are cautious about making the required investment and need convincing that the funds would be put to the best possible use. Naturally, they cannot be convinced of this until there is sufficient experience of robot use for them to rely on. Catch 22.

1.3 Two Main Robot Categories

Robots can be divided into two main groups: preprogrammed, stationary robots, which are easy to use but which are only capable of performing preprogrammed tasks, and directly-controlled, wheelchair-mounted robots, so-called manipulators, which are flexible but difficult to control. Examples of these two main types are the RAID workstation and the Manus manipulator, which are discussed in this thesis.

RAID (Bolmsjö, Neveryd and Efring, 1995) is a preprogrammed stationary robot adapted for computer-based office work, see Figure 1.1. The advantage of office work compared with industrial work is that the meaningful job tasks remain even though the handling tasks have been robotized. Examples of tasks which the robot can perform include picking up sheets of paper from a printer or turning the pages of a book. These movements are programmed when the robot is installed and can subsequently be quickly and easily activated by pressing a button or selecting from a menu on a computer display. Common drawbacks associated with preprogrammed robots are low reliability when carrying out complicated tasks and an inability to grasp objects that are slightly out of place. In order to be usable in connection with office work the robot must be capable of handling books and sheets of paper. A reliable page-turning method is required, for going forward as well as back, one page or several pages at a time. The end-effector must be capable of separating the pages so that only one page is turned, and this page should be turned using a movement adapted to the type, size, and paper quality of the book. Preprogrammed robots have limited adaptive ability, thus making it more difficult to handle pliable objects such as books and sheets of paper.

The most common directly-controlled wheelchair-mounted robot is the Manus manipulator (Verburg, Kwee, Wisaksana, Cheetham and van Woerden, 1996), which is suitable for activities



Figure 1.1 The RAID workstation is positioning a book on the readerboard.



Figure 1.2 The wheelchair-mounted Manus manipulator opening a kitchen cupboard.

of daily living, see Figure 1.2. With this device, the user controls every movement of the robot using a keypad or a joystick. With the Manus, the user can pick up objects from the floor, get things from shelves, open the refrigerator, pour himself a glass of water, look at private papers, etc. Since the Manus is mounted on the user's electric wheelchair, it has the advantage of being easy to take along. Drawbacks associated with directly-controlled robots are that they may require concentration, thus making the user tired, and that it may take a long time to complete a task. The size and weight of a wheelchair-mounted robotic arm may also have a negative impact on accessibility and precision driving. Grasping and insertion movements requiring precision are particularly difficult, since it is necessary to control both the position and the orientation of the robotic arm when performing such movements. It is sometimes advisable to limit the high flexibility of directly-controlled robots to enable faster and easier robot use. An automatic grasping function may be a useful.

1.4 Useworthiness

Let me, even at this early stage, briefly explain why the concept of useworthiness is needed and why it will be introduced in the thesis.

Whether a person wants to use a robotic aid or not depends not only on what the robot can be used for, how easy it is to use, and what it looks like, but also on the user's priorities when it comes to the needs he wishes to fulfil and the availability of other assistive devices. Does he/she want to carry out a task independently with the aid of the robot or does he/she prefer to be assisted by a personal assistant or relative?

"Is the robot *worth using*, i.e. can it fulfill the needs that are the most important ones to me?"

Advanced and versatile assistive devices such as robots can often increase awareness of the needs, abilities, wishes and dreams of users, since it is necessary to consider and discuss which activities one would really wish to carry out with the aid of the robot. To determine whether a robot is worth using, one must go to the heart of the matter (Jönsson, 1997). The individual user must consider questions such as "What is important in my life?" "What are my priorities?" "Do I really need a robot as an assistive device?" "What important tasks can the robot help with?" "Is it good at carrying out those tasks?" "Are there more pros than cons?" "Is the robot worth using, i.e. can it fulfill the needs that are the most important ones to me?"

More general questions include the following: What are the tasks that a robot should be able to carry out? Why do some people think robots are worth using while others do not? What important needs can a robot fulfill where those individuals are concerned? In what situations do people choose to use the robot and in what

situations do they choose not to use it? Why? What are the advantages and drawbacks of using a robot over other alternatives such as personal assistance? In what way may the advantages outweigh the disadvantages? How does using a robotic aid affect the user?

1.5 Certec as a Platform

Since 1989, Certec, Center for Rehabilitation Engineering Research at Lund University, has been building experience and knowledge in the field of rehabilitation robotics. The Center collaborates with organizations in the fields of rehabilitation and robotics. Such organizations include the Department of Rehabilitation at Lund University Hospital, AmuGruppen Hadar AB in Malmö, the Labor Market Institute in Vejbystrand, and the Division of Robotics at Lund University.

In an international context, Certec has participated in two EU projects in the field of robotics in collaboration with European corporations, universities, and organizations. In these projects, the RAID workstation was developed and evaluated between 1993 and 1996. Certec was responsible for developing end-effectors which are capable of getting books from a bookshelf, turning the pages of those books, inserting diskettes to a computer, picking up sheets of paper from a printer, and delivering a glass containing a beverage.

In 1997, a National Rehabilitation Robotics Center was created within the Department of Rehabilitation at Lund University Hospital. At the Center, people with physical disabilities have the opportunity to try the RAID workstation and the wheelchair-mounted Manus manipulator.

Certec has participated in two workplace installations involving robots and has installed a wheelchair-mounted robotic arm:

- 1990, office environment at Skanska, Helsingborg, Mr Christer Evaldsson, high-level spinal cord injury, RTX robot.
- 1992, office environment at Samhall-Hadar, Malmö, person with cerebral palsy, RTX robot.
- 1998, Göteborg, Ms Eva Gerdén, spinal muscular atrophy, Manus.

Additionally, the following robot installations have been carried out in Sweden:

- 1991, office environment at the Swedish Handicap Institute, Stockholm, Ms Åse Rambrink, cerebral palsy, RTX robot. No longer in use.
- 1993, mail sorting, Volvo central mail service, Göteborg, Ms Ann-Christine Olsson, cerebral palsy, CRS robot.
- 1995, chopping wood, Alingsås Environmental Station, Mr Henrik Lundblad, cerebral palsy, excavator with grapples.

1.6 Thesis Outline

This doctoral thesis deals with robotics and new opportunities for people with physical disabilities. I focus on the user and the use of the technology, and, in particular, on what makes robotic aids worth using – useworthiness as distinguished from usability.

The thesis demonstrates that user trials with robots as assistive devices can result in new knowledge about both the use of the technology itself and the personal characteristics – needs, abilities, wishes, and dreams – of the user.

- Chapter 2 Chapter 2 comprises an overview of the field of Rehabilitation Robotics, including references to articles dealing with problems related to this thesis.
- Chapter 3 In Chapter 3, I introduce and analyze the concept of useworthiness, the purpose of which is to focus on the importance of a product's functionality in the user's life situation, and compare it to various definitions of usability and usefulness.
- Chapter 4 Chapter 4 describes the development of end-effectors for the RAID workstation for tasks such as page-turning. I discuss the principles concerning the separation of pages and the page-turning movement and present results from various steps in the development of the end-effectors. The performance requirements for the automatic grasping function for simplified robot use have been brought out through user trials of the RAID workstation. The chapter includes the following articles:
- Håkan Efring, Gunnar Bolmsjö. *RAID – A Robotic Workstation for the Disabled*. Proceedings of the 2nd European Conference on the Advancement of Rehabilitation Technology (ECART 2), pp. 24.3, Stockholm, Sweden, May 1993.
 - Håkan Neveryd, Gunnar Bolmsjö, Håkan Efring. *Robotics in rehabilitation*. IEEE Transactions on Rehabilitation Engineering, vol. 3, no 1, pp. 77-83, March 1995.
 - Håkan Efring. *Robot control methods and results from user trials on the RAID workstation*. Proceedings of the fourth International Conference on Rehabilitation Robotics (ICORR), pp. 97-101, Wilmington, Delaware, USA, June 1994.
- Chapter 5 Chapter 5 describes user trials of the wheelchair-mounted Manus manipulator at the national rehabilitation robotics center in the Department of Rehabilitation at Lund University Hospital. I describe results from the user trials and the requirements which robotic devices must meet. The chapter includes the following articles:

- Håkan Efrting, Kerstin Boschian, Bengt Sjölund. *The Manus Manipulator as a Tool for Rehabilitation*. To be published in the Scandinavian Journal of Rehabilitation Medicine.
- Håkan Efrting, Kerstin Boschian. *Technical results from Manus user trials*. To be published in the Proceedings of the sixth International Conference on Rehabilitation Robotics (ICORR), Stanford, California, USA, July 1999.

Chapter 6 is an edited version of a discussion about the useworthiness of robots with a Manus user who had been using the manipulator for a couple of months.

Chapter 6

Chapter 7 describes and analyzes the experience gained from the Manus user trials. Difficulties encountered in the trials are described, as well as the movements of the end-effector when performing common tasks. I also provide examples of possible ways of simplifying robot use.

Chapter 7

Chapter 8 deals with ethical issues related to the development and trials of robots for people with physical disabilities.

Chapter 8

Chapter 9 is an analysis and evaluation of the results presented in the thesis, and presents the conclusions which can be drawn concerning the useworthiness of robots to people with physical disabilities.

Chapter 9

1.7 Primary Contributions

To conclude this introduction, I would like to highlight what I consider to be the primary contributions of this thesis to the field of Rehabilitation Robotics:

- The introduction of the concept of useworthiness as a means of focusing on the importance of a product's functionality in the user's life situation. The concept of useworthiness
- Further development of end-effectors, which in themselves are essential to the functionality of the robot. A technical solution is presented for the design of page-turning end-effectors for separating pages in books and documents, as well as parameters controlling the movements of the robot in connection with page-turning involving books of various sizes. Development of end-effectors
- Results of trials of highly functional and versatile robots, particularly the wheelchair-mounted Manus manipulator, and an in-depth interview with a test user. Results of trials
- Suggestions for how robot use can be simplified to reduce the considerable amount of concentration required when using directly-controlled robots. The simplifications are based on an analysis of the movements of the end-effector when performing common tasks. Simplified robot use

2 Rehabilitation Robotics

In this survey I mainly list references dealing with robots as compensatory assistive devices for people with physical disabilities.

I do not list references dealing with robots used in the field of medicine, for example for operations requiring high precision. More information about the field of medical robotics can be found at the *Medical Robotics and Computer Assisted Surgery Jumpstation*: <http://www.ius.cs.cmu.edu/mrcas/mmenu.html>

Other areas which are not included in this survey are robots in physiotherapy, mobile robots, humanoid robots, and the fields of prosthetics and powered orthoses.

2.1 Sources

A good way to make oneself acquainted with the field of Rehabilitation Robotics is to study the following special editions of scientific journals:

Journals

- Robotica, vol 11, part 6, Nov-Dec 1993.
<http://www.cup.cam.ac.uk/journals/rob/>
- IEEE Transactions on Rehabilitation Engineering, vol 3, no 1, Mar 1995.
http://www.ieee.org/organizations/pubs/pub_preview/RE/re_bkissue.html
- Technology and Disability, vol 5, no 2, Sep 1996.
<http://www.elsevier.nl/inca/publications/store/5/2/5/0/2/3/>
- Robotica, vol 16, part 5, Sep-Oct 1998.
<http://www.cup.cam.ac.uk/journals/rob/robotoc.htm>

A monograph edited by Dr Foulds contains fourteen papers, where researchers from the United States, Canada, France, the Netherlands and Great Britain present early development projects and results from user trials:

- Interactive robotic aids – One option for independent living: An international perspective, Monograph 37, New York, World Rehabilitation Fund, 1986.

ICORR, International
Conference On
Rehabilitation Robotics

Since 1990, the field of Rehabilitation Robotics has its own conference: *ICORR, the International Conference On Rehabilitation Robotics*. Six conferences have been held:

- 1990, A I duPont Institute, Wilmington, Delaware, USA.
- 1991, Georgia Institute of Technology, Atlanta, Georgia, USA.
- 1992, Keele University, Keele, Staffordshire, Great Britain.
- 1994, A I duPont Institute, Wilmington, Delaware, USA.
- 1997, Bath Institute of Medical Engineering, Bath, Great Britain. <http://www.bath.ac.uk/Centres/BIME/icorr97.htm>
- 1999, Stanford University, Stanford, California, USA. <http://rehabrobotics.org/>

Next conference will be held in May or June 2001 in Paris, France. The same URL will be used: <http://rehabrobotics.org/>

Rehabilitation Robotics
Jumpstation

The central location for information about actors, organizations etc. within the field of Rehabilitation Robotics is the *Rehabilitation Robotics Jumpstation*, compiled by Dr John L Dallaway: <http://www.dllwy.freeserve.co.uk/rrjump/> It contains the following headlines: Actors, conferences, organizations, papers, products, projects, related sites and theses.

2.2 Survey Papers

There are a number of survey papers describing important research and development projects.

A thorough review of the literature has been presented by Kassler (Kassler, 1993).

Dallaway, Jackson and Timmers present a large number of projects in Europe, including projects within the TIDE program. Some of the robots described are the wheelchair-mounted arms Manus, InventAid and Tou, the stationary RTX robot, also part of the Master and RAID workstations, the Handy 1 eating aid and the Wessex trolley-mounted robot (Dallaway, Jackson and Timmers, 1995).

A corresponding survey of North American projects is presented by Harwin, Rahman and Foulds. They describe the stationary robots RAA/Regenesis and DeVAR, the pneumatically controlled ISAC robot and the wheelchair-mounted arms Helping Hand and the Myoelectrically Controlled Object Manipulator/RoboArm (Harwin, Rahman and Foulds, 1995).

Jackson presents an overview of the robots Handy 1, DeVAR, RAID, InventAid, Manus and the Wessex trolley-mounted robot (Jackson, 1993).

In another overview, Hillman presents DeVAR, RTX, the Wessex trolley-mounted robot, RAA/Regenesis, Handy 1 and a number of test installations of different stationary robots. The wheelchair-mounted arms Manus and InventAid are also

presented. Finally, Hillman presents a number of evaluations carried out with DeVAR and Handy 1 (Hillman, 1992).

2.3 Needs and Utility

Stanger and Cawley analyze the needs of robotic aids for people with different types of diseases and injuries. They write: “By understanding user demographics and the market potential for such a device, an assistive robot can be designed and marketed to optimally meet the needs of the targeted audience.” (Stanger and Cawley, 1996).

Stanger, Angelin, Harwin and Romilly present a summary of nine studies of users’ task priorities. Four of these studies were carried out without having any specific robot in mind and five of the studies were carried out with reference to the robots evaluated, i.e. a robot from BIME, Bath Institute of Medical Engineering, RAA/Regenesis, DeVAR, Manus and InventAid. The authors write: “In the field of rehabilitation robotics and powered orthoses, the design of a successful device also requires a clear understanding of what functionality, or what task priorities, the users require of the device.” (Stanger, Angelin, Harwin and Romilly, 1994).

Napper and Seaman present some forty activities for increased independence. These activities originate from ten studies, where these activities have been proposed or implemented (Napper and Seaman, 1989).

Engelhardt emphasizes the importance of evaluations with users for the development of the field of Rehabilitation Robotics. Engelhardt writes: “The identification of tasks that will need to be performed and the aspects of the task that will be augmented by the robot must be clearly defined and quantitatively described.” The author lists over twenty activities in order of priority, calculated from the number of twenty users wishing to perform the activities (Engelhardt, 1986).

2.4 Rehabilitation Robots

Verburg, Kwee, Wisaksana, Cheetham and van Woerden present an overview of the twenty years’ development of the Dutch wheelchair-mounted Manus manipulator and the evaluations carried out (Verburg, Kwee, Wisaksana, Cheetham and van Woerden, 1996). Kwee describes the early development from the Spartacus project to the Manus manipulator (Kwee, 1986) and the work spent on making hard robots soft, i.e. adapted to man (Kwee, 1995). Kwee also presents different user interfaces developed for the Manus arm and proposes how the use of the Manus arm can be simplified (Kwee, 1998).

Manus Manipulator

A number of papers describe the development of the Manus arm in detail. There is an early description of the Manus arm (Kwee, Duimel, Smits, de Moed, van Woerden, van der Kolk and Rosier, 1989) and a description of how the user interface can be configured (Kwee, Thönnissen, Cremers, Duimel and Westgeest, 1992). At Bloorview MacMillan Rehabilitation Centre in Canada a number of input devices have been evaluated and the Manus arm has been mounted on a retractable frame, so it can easily be moved to the back of the wheelchair when not in use (Verburg, Naumann, King and Bennett, 1993).

Kwee describes how the communication standard M3S and the Adapticol language increase the possibilities to adapt the Manus arm to individual users (Kwee, 1997). In another paper the POCUS project is presented, where the user interface of the Manus arm is adapted to people with cerebral palsy (Kwee, Quaedackers, van de Bool, Theeuwen and Speth, 1999).

Didi, Mokhtari and Roby-Brami have developed the Manus user interface further and have evaluated it, to simplify rough positioning of the Manus arm and orient the gripper correctly for a number of activities (Didi, Mokhtari and Roby-Brami, 1999). The results from these evaluations will be used in the European project Commanus, which started in November 1998. Methods to record how, and how fast, a user can control the Manus arm are presented (Mokhtari, Roby-Brami and Laffont, 1997).

The Manus manipulator has been evaluated at a number of rehabilitation centers, e.g. in Canada (Milner, Naumann, King and Verburg, 1992), (Verburg, Milner, Naumann, Bishop and Sas, 1992). User trials have also been carried out in Norway (Øderud and Bastiansen, 1992), France, German (Bühler, Hoelper, Hoyer and Humann, 1995) and the Netherlands (Peters and de Moel, 1996), (Stuyt, 1997).

Helping Hand KRI, Kinetic Rehabilitation Instruments, in the United States has developed the Helping Hand, a wheelchair-mounted robot, less advanced than the Manus arm (Sheredos, Taylor, Cobb and Dann, 1995). Results from a six months' evaluation are described in (Sheredos, Taylor, Cobb and Dann, 1996) and (Sheredos and Taylor, 1997).

InventAid arm InventAid is a wheelchair-mounted robot based on the pneumatically controlled air muscles Flexator, manufactured by AirMuscle Ltd in England (Hennequin, 1992). Seven users in Canada have evaluated the InventAid arm (Mattie and Hannah, 1994).

Myoelectrically Controlled Object Manipulator/RoboArm A small, myoelectrically controlled, wheelchair-mounted robot has been developed by Bloorview MacMillan Centre in Canada and evaluated by one user (Bush, Al-Temen, Hancock, Bishop, Slack and Kurtz, 1994).

BIME, Bath Institute of Medical Engineering, Great Britain, has developed and evaluated a number of robots. A compilation of early developments has been presented (Hillman, Pulling, Gammie, Orpwood and Stammers, 1991). Five persons with physical disabilities have tried the commercial educational Atlas robot in their homes, to find out what possibilities a desktop-mounted robot has (Hillman, 1987). The Atlas robot, with a spherical working space, has been integrated with its peripheral equipment, "the Atlas workstation", to be able to insert diskettes and audio cassette tapes and to be able to retrieve books from a shelf. Six users evaluated "the Atlas workstation" (Hillman, Pulling, Gammie, Stammers and Orpwood, 1991). With experience from user trials, the robot has been changed to a home made robot of type SCARA and was renamed "the Wolfson workstation" (Hillman, Pullin, Gammie, Stammers and Orpwood, 1990). Five users evaluated "the Wolfson workstation" (Hillman and Jepson, 1992).

BIME robots

This stationary robot was later mounted on a trolley, "the Wessex trolley-mounted robot". The design, described in (Hillman, Gammie and Orpwood, 1992) and (Hillman and Gammie, 1994), has been evaluated for three months in one user's home (Hillman and Jepson, 1997). A wheelchair-mounted prototype is described in (Hagan, Hagan, Hillman and Jepson, 1997) and the final assembly is presented in (Hillman, Hagan, Hagan, Jepson and Orpwood, 1999).

The Handy 1 eating aid, developed at Keele University, Great Britain, is the most widely used robot today. A description of the development is presented in (Topping and Smith, 1999). The development of three new trays for washing, shaving and tooth brushing, make-up and drawing is also described in (Topping, Heck and Bolmsjö, 1997) and (Topping and Smith, 1998). Handy 1 is marketed by Rehab Robotics Ltd, Great Britain, and in 1997 Handy 1 was used by about 110 persons (Smith and Topping, 1997). There is a description of the early development in (Hegarty and Topping, 1991).

Handy 1

Evaluations of Handy 1 are presented in (Whittaker, 1992), (Hegarty and Pinnington, 1992), (Topping, 1993), (Pinnington and Hegarty, 1994) and (O'Connell and Topping, 1999).

Van der Loos presents an overview of the development and evaluation of DeVAR (Desktop Vocational Assistant Robot), which was developed within the rehabilitation robotics program initiated by professor Larry Leifer in 1978 (Van der Loos, 1995). This program was a co-operation between The Rehabilitation Research and Development Center of the Palo Alto VA and Stanford University Department of Mechanical Engineering. The

DeVAR

need for user trials during research and development as well as methods used are presented by Hammel (Hammel, 1995).

An early evaluation with 24 test users of the DeVAR-III version for ADL activities is presented in (Hammel, Hall, Lees, Leifer, Van der Loos, Perkash and Crigler, 1989). A fourth generation of the robot, DeVAR-IV designed for office work, was installed in an office of a person with a high-level spinal cord injury. An evaluation after three months is presented in (Van der Loos, Hammel, Lees, Chang, Perkash and Leifer, 1990). A comparison between robot and human assistants at the DeVAR workstation is presented in (Hammel, Van der Loos and Perkash, 1992). In another evaluation four persons with high-level spinal cord injuries have tried the DeVAR workstation (Taylor, Cupo and Sheredos, 1993). The evaluation methods used are reported in (Hammel and Van der Loos, 1991).

The problems of disseminating robots to a wide range of users are analyzed in (Van der Loos and Hammel, 1990) and (Van der Loos, Hammel and Leifer, 1994). The use of DeVAR in an educational setting is described in (Van der Loos and Hammel, 1994).

RAA/Regenesis

NSF, Neil Squire Foundation, in Canada has developed and evaluated a stationary robot for office applications, RAA, Robotic Assistive Appliance (Birch, 1993). The robot has been marketed by the subsidiary company Regenesis Development Corporation. A description of the robot and the evaluation sites is reported in (Birch and Cameron, 1990), (Birch and Fengler, 1992) and (Birch, Fengler and Gosine, 1993). An evaluation method has been developed, where the effectiveness of typical office tasks is compared for people using the RAA/Regenesis workstation and when they are not (Birch, Fengler, Gosine, Schroeder, Schroeder and Johnson, 1996).

RAID

An overview of the development and evaluation of the RAID workstation (Robot to Assist the Integration of the Disabled), capable of handling books, paper sheets and diskettes, is presented by Jones (Jones, 1999). User trials from the RAID project is presented in (Danielsson and Holmberg, 1994a) and (Danielsson and Holmberg, 1994b). A technical description of the end-effectors is presented in (Bolmsjö, Neveryd and Efring, 1995), which can be found in this thesis. Early presentations of the RAID workstation has been published (Finlay, Détriché, Bolmsjö, Jones and Jackson, 1992), (Dallaway and Jackson, 1992), (Dallaway and Jackson, 1993) and (Efring and Bolmsjö, 1993). The latter can be found in this thesis.

Master

The French Master system is a predecessor of the RAID workstation and they are both based on an RTX robot. Master is also a programming language for robots. A description of the

Master system and an evaluation are presented in (Cammoun, Détriché, Lauture and Lesigne, 1993). The Master system has been described in a number of conference papers: (Détriché and Lesigne, 1990), (Détriché, Lesigne and Bernard, 1991), (Détriché and Lesigne, 1991) and (Cammoun, Détriché and Lesigne, 1992).

A second version, Master2, used in the RAID workstation is presented in (Cammoun, Détriché, Lauture and Lesigne, 1994). In a third version of the Master system, AFMASTER, the RTX robot has been exchanged to a SCARA robot, manufactured by AFMA Robots, France (Gelin, Coulon-Lauture, Lesigne, Le Blanc and Busnel, 1999).

CURL (Cambridge University Robot Language) is a robot independent programming language and environment, which can be used for the RAID workstation as an alternative to the Master language. CURL is presented in (Dallaway, Mahoney, Jackson and Gosine, 1993). A comparison between robot languages, e.g. CURL and the graphical language Roboglyph, is presented in (Harwin, Gosine, Kazi, Lees and Dallaway, 1997), as well as an icon-based drag and drop interface to CURL. This drag and drop version has been compared to an interface based on WiViK (Windows Visual Keyboard) and has been evaluated by five test users (Dallaway, 1996).

CURL

An evaluation of RoboGlyph is presented in (Lees and Leifer, 1994).

RoboGlyph

3 Useworthiness

3.1 The Purpose of the Concept of Useworthiness

The purpose of the concept of *useworthiness* is to focus on the importance of a product in the user's life situation, thereby gaining increased knowledge of the needs of the user. The focus of the related concept of *usability* (Nielsen, 1994), (Lindgaard, 1994) and (Löwgren, 1993) is more focused on the user interface, i.e. the ease and efficiency with which a product can be used, and to some extent on the functionality and versatility of the product, i.e. the tasks for which the product can be used.

Knowledge of the needs of users with disabilities can be used not only for establishing user requirements and developing more useworthy robots, but also for developing other technical tools, as well as for rehabilitation purposes.

Another purpose of the concept of useworthiness is to give the user the initiative and the power. No-one else can determine what is worth using for the person concerned. This may seem like a disadvantage if one wants to develop useworthy technology. However, by gathering experience of what different people find worth using it is possible to form a general idea of what many people who have similar interests and impairments, who are of the same age, etc. find worth using, and to develop technology to suit their requirements. In each specific situation, one must always engage in a discussion to determine the needs of the individual user. In this connection, the concept of useworthiness is a way of prioritizing all the useful tasks a robot can be used for.

Useworthiness a new concept which I introduce in this thesis, is *the individual user's assessment of the extent to which the technology meets the user's high-priority needs.*

3.2 Definitions of Usability

Nielsen employs usefulness as an umbrella term for utility and usability (Nielsen 1994), see Figure 3.1.

- *Utility* is the question of whether the functionality of the system in principle can do what is needed.
- *Usability* is the question of how well users can use that functionality.
- *Usefulness* is the issue of whether the system can be used to achieve some desired goal.

Usability according to Nielsen

Nielsen then defines usability as the sum of the following factors:

- Learnability
- Efficiency of use
- Memorability
- Few and noncatastrophic errors
- Subjective satisfaction

Figure 3.1 How Usability relates to other concepts according to Nielsen. Usefulness comprises utility and usability (Nielsen 1994, page 25).

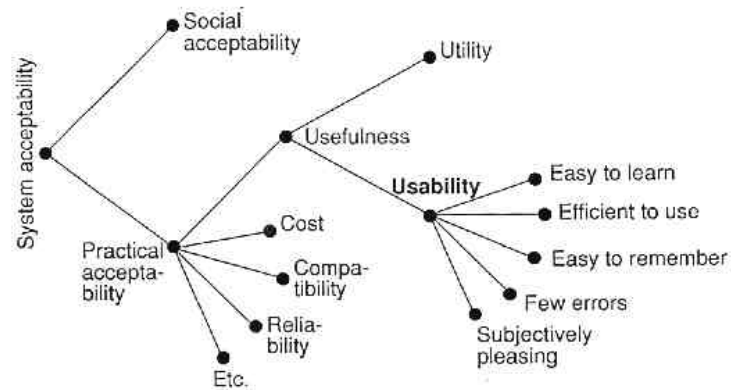

In the case of a robot which, for example, turns the pages of a book, utility concerns what the robot should be capable of doing. Can it turn pages forwards and backwards? Can it turn the pages of all types of books? Can the robot change books and begin turning the pages of a new book?

Usability is the question of how easy it is to learn how to use the robot, how efficient the robot is once the user knows how to use it, how easy it is to remember how to use it after a period of not using it, how often minor or catastrophic errors occur, and how pleasant it is to use.

Usefulness is a combination of utility and usability, i.e. whether the robot can be used for its intended purpose. Can the user turn pages in the way that was intended?

Usability according to Lindgaard

Lindgaard also makes a distinction between usability and utility (Lindgaard, 1994):

- “Usability is related to human performance in the specific tasks supported by the computer system and to the user’s attitude towards the system.” “Usability is thus expressed in quantifiable, measurable terms by which to assess when a ‘good’ system is ‘good enough’.”
- “Usefulness...” – corresponding to Nielsen’s concept of utility – “... is a separate entity which is defined in the requirements capture stage in terms of the tasks to be supported and explicit links between tasks, the attainment of which must be 100% unless renegotiated and modified during the system development process.”

Eason states that (Eason, 1984):

- The major indicator of usability is whether a system or facility is being used.

The disadvantages of this definition are that it is impossible to express usability in quantifiable, measurable terms and that it is impossible to know anything about the usability of a system or facility in advance.

An ISO standard provides another definition of usability (ISO 9241). In this standard, usability is defined as:

- “The extent to which a product can be used by specified users to achieve specified goals with effectiveness, efficiency and satisfaction in a specified context of use.”

Effectiveness is defined as:

- “Measures of the accuracy and completeness of goals achieved.”

And efficiency is defined as:

- “Measures of the accuracy and completeness of goals accomplished relative to the resources (e.g. time, human effort) used to achieve the specific goals.”

According to Löwgren, usability is the result of Relevance, Efficiency, Attitude, and Learnability (REAL) (Löwgren, 1993):

- “The relevance of a system is how well it serves the users’ needs.”
- “The efficiency states how efficiently the users can carry out their tasks using the system.”
- “Attitude is the users’ subjective feelings towards the system.”
- “The learnability of a system is how easy it is to learn for initial use and how well the users remember the skills over time.”

Usability according to Eason

Usability according to ISO 9241

Usability according to Löwgren

3.3 Definition of Useworthiness

I have chosen Nielsen’s definition of usability as the starting-point for my definition of useworthiness since he provides a relatively detailed breakdown of the concept usability and also describes how the concept forms part of a larger context (Nielsen, 1994). In this wider perspective, it is possible to introduce a concept such as useworthiness.

I have chosen to define useworthiness in the following way:

- Useworthiness is the individual user’s assessment of the extent to which the technology meets the user’s high-priority needs.

In Nielsen’s figure, I have substituted useworthiness for usefulness and added “the user’s high-priority needs”, see Figure 3.2. Useworthiness is a combination of utility, usability, and the user’s high-priority needs.

Figure 3.2 Useworthiness comprises utility, usability, and the user's high-priority needs.

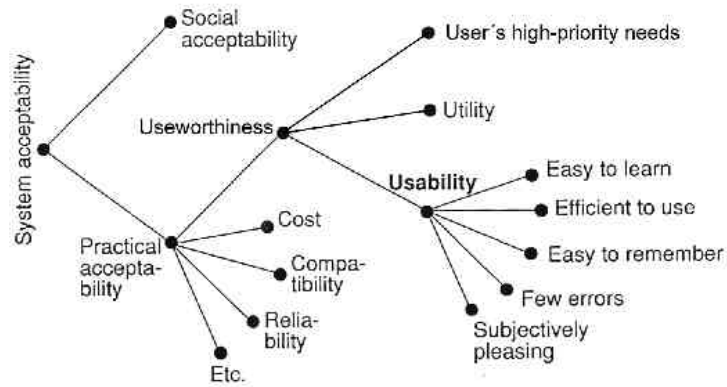

In other words, useworthiness is the user's assessment of the extent to which technical possibilities fulfil human needs.

The same product may have high useworthiness but low usability, which is the case if the utility of the product is low and the user interface is unsatisfactory but the product meets one of the user's high-priority needs. The product may be useworthy even though it is never used. The user knows that the product is capable of performing a task that is important to him or her, but for practical reasons, not necessarily connected to the product, it is impossible for the user to use the product. On the other hand, just because a product is used, it is not necessarily worth using. The user may be forced to use it or may have no other alternative, or the product may not meet the user's high-priority needs.

The user's motivation when it comes to using the system is an important component of the concept of useworthiness. A high degree of correspondence between possibilities and needs leads to high motivation and a desire to use the system.

When the user sees new possibilities and finds his motivation, his way of thinking may change. Ingrained patterns and subconscious limits to what is possible may be broken, and the user may become more active and grow as a person.

In my opinion, the above definitions of utility, usability, and usefulness do not encompass the concept of useworthiness. However, some of the definitions hint at this concept:

- Nielsen: "Usefulness is the issue of whether the system can be used to achieve some desired goal." In this definition it is not clear what is meant by "some desired goal". Is it the manufacturer's goal or the user's goal? At any rate, it does not refer to the user's high-priority needs.
- Nielsen: "Utility is the question of whether the functionality of the system in principle can do what is needed." The user's high-priority needs are not referred to in this definition either.

- Nielsen: “Subjective satisfaction.” The fact that a product is pleasant to use it not the same thing as the user’s high priority needs.
- Löwgren: “Relevance.” is “... how well it serves the user’s needs” does not take the user’s high-priority needs into consideration.
- Löwgren: “Attitude.” Just like Nielsen’s “subjective satisfaction”, “attitude” is more a matter of whether something is pleasant.

3.4 The Useworthiness of Robots

In Chapter 6, I discuss the useworthiness of robots with a user of the wheelchair-mounted Manus manipulator. The primary purpose of the interview is to determine the needs and priorities which make the Manus useworthy in her opinion.

Increased knowledge of what makes robots worth using for different people makes it possible to develop better robots and to establish requirements for other assistive devices for people with physical disabilities.

When discussing the advantages and drawbacks of robots one must keep in mind that there are advantages and drawbacks on two different levels: the practical level and the value level. The concept of useworthiness can be seen as a *combination* of all of the boxes in Figure 3.3.

	Advantages	Drawbacks
Value level		
Practical level		

Figure 3.3 Advantages and drawbacks on different levels.

One often mentions the advantages on the value level and the drawbacks on the practical level, but for individuals who do not want a robotic aid the drawbacks on the practical level may not be the deciding factor. A single drawback on the value level may be important enough for the robot not to be useworthy. A person may see independence as something negative, which makes it a drawback on the value level.

The factors which influence the useworthiness of a robot are usability (e.g. easy to learn, few errors...), utility (e.g. turning pages, drinking...), and motivation (“I can make a cake with the aid of the robot, and I love cake...”)

In order to increase the useworthiness of a device one must study the components included in the concept. Usability can be

improved by making the robot easier to control, by developing an automatic grasping function or task-related control. Utility can be improved by developing better end-effectors with more functions. Motivation increases if there is greater a correspondence between the operations the robot is capable of performing and the user's high-priority needs. One reason why people with physical disabilities do not make extensive use of robots is the absence of a clear description of user requirements based on the needs of users.

Advantages on the value level are difficult to attain, partly because "quality of life", for example, means different things to different people, and partly because what is achieved is usually only an improvement, not a total solution. It is difficult to become completely independent because human back-up is always necessary in case the technology fails.

4 Development of the RAID Workstation

4.1 The RAID and EPI-RAID Projects

The RAID workstation was developed and evaluated in two EU projects: RAID (1991-93) and EPI-RAID (1993-96). In addition to computer-based tasks, office work involves handling books and documents. One of the requirements specified for the RAID workstation was that it should enable a user to work independently for four hours. This means that, in addition to turning the pages of books and documents, a robot used by a person with a physical disability for handling books and papers must be capable of moving the books or papers to and from a readerboard. It should also be capable of handling diskettes and serving beverages.

4.1.1 RAID, Robot to Assist the Integration of the Disabled

The purpose of the RAID project was to develop a workstation and demonstrate it to people with physical disabilities. The first version was called RAID1, see Figure 4.1. Three individuals with high-level spinal cord injuries participated in the RAID1 trials, which were carried out at AmuGruppen Hadar AB, Malmö, Sweden.

RAID1 comprises the following parts:

- A modified RT100 robot with an extended column mounted on a linear rail.
- A book gripper and a page turner. The page turner can also grasp diskettes, sheets of paper, and a tray with a soft drink can.
- A noiseless air compressor, 45 dB(A)
- Two shelves for a maximum of 17 books
- Sixteen compartments for A4 paper
- Six compartments for A3 paper
- Ten compartments for 3½" diskettes
- Two compartments for optical read/write diskettes
- Four CD-ROM compartments
- A tray big enough for a soft-drink can with a straw
- A laser printer for A4 and A3 paper
- A scanner for scanning images into the computer
- A stapler for stapling A4-sized pages



Figure 4.1 RAID1, the first version of the RAID workstation

- A personal computer with disk drives for 3½" diskettes and optical diskettes, a CD player, and a fax card. The computer is also used for controlling the robot.
- Software: Microsoft Works, AutoScetch, and WiViK keyboard emulation software.
- Infrared link between the joystick of the wheelchair and the computer

The RAID1 user interface consists of a set of buttons displayed on a computer screen. Users choose among the preprogrammed movements of the robot by first indicating the type of object they want the robot to pick up, e.g. book, whereupon the robot selects the appropriate end-effector and displays the next menu. From the menu, the user chooses where the robot should get the book, e.g. from compartment No. 1. The robot grasps the book and displays the next menu, where the user selects the location to which robot should deliver the book, e.g. to the readerboard. The robot performs the task, returns to the waiting position, and displays the main menu again. The RAID1 joystick is used both for moving the cursor on the computer screen, i.e. as a mouse replacement, and for directly controlling the robot.

4.1.2 EPI-RAID, Evaluation of Prototype and Improvements of the RAID workstation



Figure 4.2 RAID2.
The final version of the
RAID workstation

In preparation for the EPI-RAID project, RAID1 was further developed and adapted for production. This resulted in the modular, intermediate version RAID1A. Nine RAID1A robots were produced. The purpose of the EPI-RAID project was to carry out user trials of the RAID1A, develop RAID2, and carry out further user trials. Three RAID2 robots, see Figure 4.2, were built and were subsequently tested by about ten users at the following rehabilitation centers: the Department of Rehabilitation at Lund University Hospital, Sweden, Papworth Group near Cambridge, England and Kerpape Rehabilitation Center near Lorient, France.

At each location two variants of the RAID2 robot were installed, each with different control systems, programming languages, and user interfaces. For the RAID2M, the French programming language Master was used (the same as was used for the RAID1), while CURL (Cambridge University Robot Language) was used for the RAID2C. A graphical user interface was developed for the RAID2C. Since there was insufficient time to program all the robot movements of the RAID2C, only the RAID2M version was tested.

4.2 My Participation in the Projects

My task in the RAID and EPI-RAID projects was to develop the end-effectors of the robot. In this section, I will describe the end-effectors I developed for the RAID1, RAID1A, and RAID2 versions of the robot. In later sections, I will provide a more detailed description of the development of end-effectors for turning the pages of books and documents.

4.2.1 RAID

In the RAID project I received a great deal of help from my colleague Ingvar Jönsson, a rehabilitation technician at Certec. I drew sketches of various solutions and Ingvar Jönsson made the prototypes. With the aid of an RT100 robot (the RAID robot comprises a modified RT100 robot) I was able to test the end-effector prototypes and, in an iterative process, we discussed how to improve the technology. The page-turning gripper was also tested on a fast IRb1000 robot from ABB. The tests were carried out in collaboration with the Division of Robotics at Lund University.

The shape and operation of the end-effectors influence and are influenced by other parts of the RAID workstation, including the readerboard, the bookshelves, and the storage compartments for papers, diskettes, CDs and beverages. Consequently, I also specified the design of the peripheral equipment.

Since the movements that the end-effectors must carry out in performing the desired tasks depend on the shape and operation of the both the end-effectors and the peripheral equipment, I programmed all the movements of the RAID1.

4.2.2 EPI-RAID

Although it was Oxford Intelligent Machines Ltd, one of the project participants, that adapted the RAID1 for production, I identified some problems in the final phase of the development which were dealt with before the trials.

In the EPI-RAID project, I made dimensional sketches of the end-effector and the readerboard, while Oxford Intelligent Machines Ltd took care of the detailed drawings and the manufacturing. With respect to other peripheral equipment I offered my comments – primarily measurements important to the operation of the end-effectors.

My main contribution to the programming work of the RAID1A and the RAID2M robots was the page-turning programs, although also I performed fine-tuning of the robot movements.

Since I developed the end-effectors and carried out a large part of the programming, I also influenced the design of the user interface, e.g. how the user tells the robot where the end-effector should open the book or how many pages it should turn. The robot can receive information either from the user or from sensors in the end-effector.

4.3 RAID – A Robotic Workstation for the Disabled

Section 4.3 has been published in the Proceedings of the Second European Conference on the Advancement of Rehabilitation Technology, ECART, pp.24.3 Stockholm, Sweden, May 1993.

Håkan Efring^{1,2} and Prof Gunnar Bolmsjö²

¹CERTEC, Center for Rehabilitation Engineering,
Lund University, Sweden

²DPME, Dept. of Production and Materials Engineering,
Lund University, Sweden

4.3.1 Abstract

The aim of the RAID project (Robot for Assisting the Integration of the Disabled) is to develop and demonstrate a prototype robotic workstation for use by disabled people. The RAID project is part of the European Community TIDE program (Technology for the socio-economic Integration of Disabled and Elderly people).

The robotized system is intended primarily for vocational use in an office environment. The selected application for the demonstration in March 1993 is CAD (Computer Aided Design), which is an application full of handling tasks for the robot. If the robot is capable of doing all these tasks satisfactory, a number of other applications can be extracted from the CAD application.

A key feature of RAID is the emphasis on user requirements.

4.3.2 Background

A number of previous attempts to develop robotized workstations have failed. A common reason has been the absence of adequate definition of task requirements by users, coupled with a very complex user interface and a bad integration of all the systems functionalities. To avoid these problems, a key feature of the RAID project is the emphasis placed on user requirements.

The following partners form the consortium for RAID:

Armstrong Projects Ltd, UK

Cambridge University, UK

Oxford Intelligent Machines Ltd, UK

Papworth Group, UK

UMI Group, UK
CEA/DTA/UR, France
Equal Design, France
HADAR, Sweden
Lund University, Sweden

The RAID project started in December 1991 and the demonstration will take place at HADAR, Malmö, Sweden in March 1993.

The robotized system is intended primarily for vocational use in an office environment. The selected application, CAD (Computer Aided Design), is an application full of handling tasks for the robot. If the robot is capable of doing all these tasks satisfactorily, a number of other applications can later be extracted from the CAD application, for example word processing, desk top publishing, calculation, computer programming, production planning and NC part programming.

Additionally, the CAD application is an activity, which is accessible to many people with severe motor disabilities.

4.3.3 User Requirements

The RAID user group is defined as follows:

Wheelchair users who have insufficient functions to be able to operate a computer workstation unaided, but who have at least two degrees of movement available: typically enough to operate a joy-stick, roller ball or chin switch.

A reference group consisting of seven individuals has been selected for the user requirements collection part of the project. The RAID workstation prototype will finally be tested on three individuals of the reference group.

The methodology used to define the user requirements is based on a number of activities:

- Selection of the reference group including individuals with knowledge and experience of using computers and in one case robotized workstations (1).
- Discussions with the group and one by one to gain knowledge of specific needs.
- Presentation of possible solutions through visual aids.
- Own experience through many years of rehabilitation work at HADAR.
- Hands-on exercises when possible on prototypes or other devices.

The user requirement specification is certainly an iterative process that will continue throughout the RAID project (2).

The users of the system can however not be seen in isolation from the environment. Thus, we have defined other users and environmental factors as well, that either have direct contact with RAID or indirect through the operator:

- The disabled operator.
- Technical support: System design, integration and individual adjustment.
- Training support.
- Colleagues at the department.
- General requirements.

The most important user of RAID is the disabled operator and it is with this person in mind the user requirements are specified. Some of the user requirements are outlined in the following:

- The users prefer to operate the system with the same device they are manipulating the wheelchair.
- The design and layout of the workstation must meet ergonomic demands in terms of light, noise level, readerboard etc. It is also preferred that the workstation look fairly normal compared with workstations for able bodied people.
- Distance to focus point. Areas where the operator often switches focus point should be placed at the same distance from the operator.
- Autonomy and reliability. Since the user group in general has limited possibility to recover any error that may occur during operation, it is very important to have as high autonomy and reliability of the system as possible.
- Safety. The workstation must be safe with respect to any interaction between the robot and the operator. Furthermore, the workstation must be believed to be safe, so that the operator safely can utilize all functionality of the system.
- It should be easy or intuitive to understand and manipulate the way the robot and RAID works.
- Functionality and access time. RAID must have a functionality that allows the operator to work in parallel with the robot. The access time of certain operations must be balanced so that the waiting time is minimized.
- It should be possible for a colleague at the department to assist without using the robot.

4.3.4 Functional Specification

It is necessary to limit the functional specification to a level which is technically achievable, giving the time scales and financial constraints placed on the project. However this has to be consistent with meeting the primary objective of producing a

viable workstation where adequate levels of productivity can be attained for acceptable periods of independent operation.

The system (including the user within it) can be considered in terms of information input, output and storage. The information within the workstation can be stored in the robot domain or the computer domain (3). The robot domain consists of bookshelves, a readerboard, document and diskette racks. The information can be moved between the robot and computer domains by using a diskette drive, a scanner and a printer. Input and output information to and from the robot domain consists of books, diskettes and paper documents, while information to and from the computer domain consists of fax and network messages.

4.3.5 Technical Specification

The technical specification takes as its primary input the functional specification and it precisely describes the way in which each function of the RAID workstation will be implemented. The technical specification outlines the following sub-systems:

- Computer hardware
- Computer software
- Wheelchair interface
- Telephone
- Scanner
- Printer
- Input and output trays
- Readerboard
- Book shelf, document and diskette racks
- Robot and controller
- Safety system
- End effectors

The 486 PC will link to a transputer-based motor control board which will replace the standard control hardware of an RTX robot arm to enhance the robot's control characteristics (3). All application software will run under Microsoft Windows graphical user interface. A Windows version of the MASTER 2 robot control language will be used in the RAID pilot phase. Thus, a single computer with a single screen will be sufficient for both the application software and the control of the robot.

4.3.6 Robot Tasks

RAID should be seen as a user led project and hence, the robot tasks are primarily defined according to the user requirements and secondary by technical aspects.

The main tasks are:

- Book handling from book shelf to readerboard.
- Opening the book at any point and page turning forwards or backwards.
- Paper handling from printer or input tray to readerboard or output tray.
- Diskette handling from diskette rack to diskette drive.
- Serving cold drinks.

Concerning layout and execution the following user requirements could be mentioned:

- Books should be stored in a normal upright position on the bookshelf.
- The robot tasks should have as short cycle times as possible.
- Fast movements towards the operator should be avoided.

4.3.7 End-effector Development

The wide range of robot tasks makes it necessary to include more than one gripper. Hence, a tool changing system is required. A tool changing system also increases the flexibility of the workstation and makes it possible to add new handling tasks in the future.

A very small tool changer has been selected, which also comply with the safety aspects. The gripper must not fall off in the event of electric power or air supply failures. The tool changer is controlled by compressed air and has a self-locking holding device for safety reasons. Four pneumatic lines and ten electric lines can be transferred to the gripper.

During the initial work of the end effectors it was evident that we should design the end effectors with as high degree of flexibility as possible in order to minimize tool changing operations. The technical solution is based on two end effectors, called *Book gripper* and *Page turner*.

The book gripper is based on a pneumatic clamping device and is capable of grasping books, catalogues, manuals and ring bound files with varying thickness and size. The grasping function is supported with a small shelf to reduce the required clamping force.

Some modifications have to be made at the bookshelves to make it possible to grasp a book. The books need to be stored in different compartments on the bookshelves. However, the books can be stored in a normal upright position according to the user requirements.

The books are handled between the input tray, the bookshelves and the readerboard.

The page turner is designed to open books, page turn forwards and backwards, handle up to approx. 50 paper sheets of varying size, handle diskettes and serve refreshments on a specially

designed tray. The paper sheets can be moved between the printer, the readerboard, the storage racks and the input and output trays.

One knife, two pneumatic clamping devices and a suction cup are the grasping devices of the page turner. The knife is used to open a book. The suction cup is used to lift a single page at a top corner and the page is then grasped and turned. The second clamping device is used to grasp paper sheets, diskettes and the refreshment tray.

Some arrangements must be made at the readerboard, to prevent unwanted page movements. Therefore a pneumatic actuator with a movable finger is mounted on the readerboard. The finger is actuated by the robot during page turning.

Initial technical tests have shown a good performance both with respect to cycle time, reliability and functionality. The user feedback information can be collected, when the user trials start in January 1993.

4.3.8 Acknowledgments

The Swedish partners of this project is supported by NUTEK, The National Board for Industrial and Technical Development, Sweden.

4.3.9 References

1. Neveryd, H. (1991) *Christer Evaldssons robotiserade arbetsplats*. Center for Rehabilitation Engineering, Lund, Sweden, Report no. CERTEC-1:91.
2. Jönsson, B. (1990) *(Re)habiliteringsteknik och forskningsbarhet*. Center for Rehabilitation Engineering, Lund, Sweden, Report no. CERTEC-5:90.
3. Dallaway, J.L. and Jackson, R.D. (1992) *RAID – A Vocational Robotic Workstation*. ICORR 92 – Conference proceedings.

4.4 Robotics in Rehabilitation

Gunnar Bolmsjö, Håkan Neveryd and Håkan Efring

4.4.1 Abstract

Robotics in rehabilitation provides considerable opportunities for improving the quality of life of physically disabled people. However, practical results have been limited, mainly because it is necessary to develop different robotics concepts for people working in different fields. This paper explores some of the developments needed and presents two projects currently underway at Lund University. The first concerns end-effector design for a robotic workstation for office-based tasks, while the

Section 4.4 has been published in IEEE Transactions on Rehabilitation Engineering, vol.3, no.1, pp.77-83, March 1995.

second relates to a mobile robotic system for use by disabled people in medical and chemical laboratories. Both projects show promising results. There is also a need for further research into developing new robotic systems for use in rehabilitation with new mechanical features, as well as programming and control suitable for every user.

4.4.2 Introduction

Rehabilitation is an activity which aims to enable a disabled person to reach an optimum level of mental, physical, and/or social functioning. Thus, rehabilitation robotics deals with advancing robotics technology to provide physically disabled people with tools to improve their quality of life and work productivity [1].

Examples of applications include vocational tasks, such as manipulative operations in a structured environment (paper handling in office-based work, test procedures in laboratory-based work, etc.) and daily living activities in structured and unstructured environments, such as game playing, educational tasks, eating, and personal hygiene [2]. This implies the use of robots in a way that is quite different from industrial applications where robots normally operate in a structured environment with predefined tasks, independently of human operators. Furthermore, industrial robots are operated by specially trained workers who have a certain amount of interest in the technology. This may not be the case in rehabilitation robotics. Thus, rehabilitation robotics have more in common with service robotics which integrate humans and robots in the same task, requiring certain safety measures and special attention to human-machine interfaces for people with little interest in programming or people with physical problems operating a specific programming device. Therefore, more attention must be paid to the user's requirements, since the user is a part of the process in the execution of various tasks. Although there is a need for a home-based service robot for general-purpose use, we have selected two application areas which relate mainly to structured environments, such as those normally found in vocational workplaces. This enables us to concentrate on functionalities defined or evaluated by users rather than novel robotics research, which may be difficult to develop to a stage necessary for practical evaluation by disabled users within a limited time frame.

However, there is a need for research and development in robotics to focus on developing more flexible systems for use in unstructured environments. Important areas of rehabilitation robotics needing further development in this regard include:

1. Mechanical design, including mobility and end-effectors.
2. Programming, control, and human-machine interfaces.

These areas will be described in more detail below.

4.4.3 Mechanical Design

Robotics for use by the disabled is an application area where, from a home-based perspective, robots integrate robots and humans both in a common work-space and in the execution of the same work task. Therefore, the mechanical design of robots for rehabilitation must take into consideration specifications which are different from those used in industrial applications and which may affect design aspects of the mechanical structure. Examples of differences are:

- payload of the robot will be in the low range (typically less than 5 kg);
- the payload/weight ratio must be much higher than in existing robots, giving priority to movability and quick set-up;
- lower accuracy is allowable if the resolution in the motion control is the same as in existing industrial robots;
- a larger work-space and a more flexible configuration will be needed compared to industrial robots of the same size;
- life cycle will be shorter for assisting robots than industrial robots;
- acceleration and velocity performance may, in general, be much lower than in heavy-duty robots; and
- design criteria must enable high volume production at a low cost.

Nevertheless, most robots used in rehabilitation today have similarities with industrial robots, such as the RT-series robots and SCORBOT, which were developed for educational purposes. An example of an adaptation of a robot for rehabilitation purposes is HANDY1, which is used to assist in eating [3], and DeVAR, which uses a PUMA robot for assisting the disabled in home-based or vocational workplaces [4].

However, new designs are on the way that will include the use of compact and flexible arms, as well as new drives/actuators. Examples of this include the wheelchair-based Manus robot [5], the Tou soft (flexible) assistant arm [6], the pneumatically driven InventAid arm [7], [8], and the compliant actuator Digit Muscle [9]. Wheelchair-mounted manipulators are becoming more interesting not only because of the manipulator itself but also because of enhancements to wheelchair control, providing it with sensors and control systems like other mobile robotic bases [10].

The development of flexible arm/link systems will also have a great impact on gripper systems, which need a high degree of flexibility in terms of maneuverability and dexterity. Despite these developments, much work is needed in the area of mechanical

design, specifically the introduction of composite materials in the arm structure with inbuilt strain gauges which may be used as flexible links with feedback of the deflection and redundant kinematics for optimal reachability.

4.4.4 Programming, Control and MMI

A basic goal in rehabilitation robotics is to design a robot to carry out unique tasks. This is in contrast to most industrial uses of robots, where robots are used in pre-programmed repetitive tasks. Another difficulty is that robots for rehabilitation may be used by anyone, unlike industrial robots, which are operated by skilled workers who, in most cases, have an interest in robotics technology. Thus, many tasks in rehabilitation robotics can be said to be unique in the sense that a movement required for a certain task, e. g. picking up a newspaper or opening a door, cannot be pre-programmed. This indicates that there is a need for manual or direct control of the robot in the way of a telemanipulator. Also needed are an increased use of sensors to guide the robot and enhance its performance in autonomous tasks as well as interface devices to program and control the robot arm. It should also be noted that direct control of the robot arm puts a high cognitive load on the user and that physically disabled persons may have difficulty operating joysticks or push-buttons in delicate movements. Thus, there is an obvious need for a certain degree of autonomy of the robotic system, such as automatic grasping, which includes recognition of a specified object in front of a sensor. A positive factor in this context is that there is a human operator working with and supervising the robot. Therefore, if a task fails to a limited extent, the user will be able to correct the situation.

To a high degree, programming and manual control of the robot corresponds to MMI (Man Machine Interface) which, for disabled people, not only puts certain demands on programming languages, but also on input devices by which the user can interact with the system. Generally speaking, robot systems should be developed to allow any input device to connect to the standard set of devices, such as keyboard emulation, mouse emulation, and serial communication through RS-232/422 interface. Since more severely disabled people need individual adaptation, this type of work is normally done at rehabilitation centers. However, in the RAID project described in this paper, the joystick used to control the electrical wheelchair is interfaced with the control language of the robot and the mouse control function of the PC. This is a good solution for most users, as it enables them to control their wheelchair with the same control device.

Taking into account both the need for an interactive programming method, as well as different interfacing devices depending on the individual disability, several attempts have been made to provide programming and control methods which resemble the interactive use of modern graphical software for personal computers. As an example, most robot languages for industrial robots are robot-oriented in that they are specially adapted to a specific robot and that all operations are carried out on the robot itself, e.g., motion types, poses, I/O. If the task is repetitive, it does not matter very much whether the robot program is defined through poses or frames which are related to the robot or attached to objects in the environment. However, if the task is frequently redefined by moving objects in the workspace of the robot, such as paper and book handling, page turning, etc., it is preferable to adopt an object-oriented approach. This means that the tasks are defined by manipulating objects and that the robot must adapt its motions and logic to fulfil the program description.

Consequently, much work in the area of rehabilitation robotics is directed toward controllers or control languages, such as MASTER [11], which allows the user to interact in the performance of a task, e.g. directing the robot by manual control, as well as advanced sensory interfacing and object or task level description which frees the user from concentrating on how the robot will operate in executing its tasks. An example of an object-oriented language is CURL [12], which provides a flexible programming environment through direct (manual) control, object manipulation, and selection/definition of procedures. An interesting development in this area is RoboGlyph [13], which uses a set of icons which graphically represent different robot actions on the screen like a storyboard. This is in line with new developments of the CURL language which, by using drag and drop techniques, make use of the possibilities of graphics. A workstation could, for example, be represented by a bookshelf and a readerboard. When the user drags a book (document) from the shelf to the readerboard, the system will activate appropriate procedures to execute the task. Another direction in the development of languages with high-level characteristics are event-based controller languages and reactive planners which are based on the state of the system and activate a certain action or procedure [14]-[17].

4.4.5 The RAID Workstation and End-effector Design

The EPI-RAID (Evaluation of Prototype and Improvement to RAID workstation) project is concerned with the development of the RAID (Robot for Assisting the Integration of the Disabled)

robotized computerized office workstation, which was developed in an earlier project. The project is part of the European Community TIDE (Technology Initiative for Disabled and Elderly People) program.

The partners in the EPI-RAID project are: Armstrong Projects Ltd, UK, Cambridge University, UK, Oxford Intelligent Machines Ltd., UK, CEA/DTA/UR, France, HADAR, Sweden, and Lund University, Sweden.

The robotized system is intended primarily for vocational use in an office environment, see Figure 4.3. The selected application areas include CAD (Computer-Aided Design) and other office computer tasks such as desktop publishing, graphics layout, and word-processing. These applications involve a large number of handling tasks for the robot and creative work for the user.

During our initial work on the end-effectors, it became evident that they should be designed with the highest degree of flexibility possible in order to minimize tool changing operations. The technical solution is based on two end-effectors, called the *book gripper* and the *page turner*.

End-effector Design

The two end-effectors are shown in Figure 4.4 and Figure 4.5. The book gripper is designed to handle books, catalogs, and manuals of varying thickness and geometrical size (maximum weight 2 kg, maximum width 75 mm) between the bookshelf and the readerboard.



Figure 4.3 RAID workstation (prototype) with moving robot, framework with bookshelves, and storage for diskettes, documents and peripherals, such as a printer, etc. Photo: Helena Alvesalo.

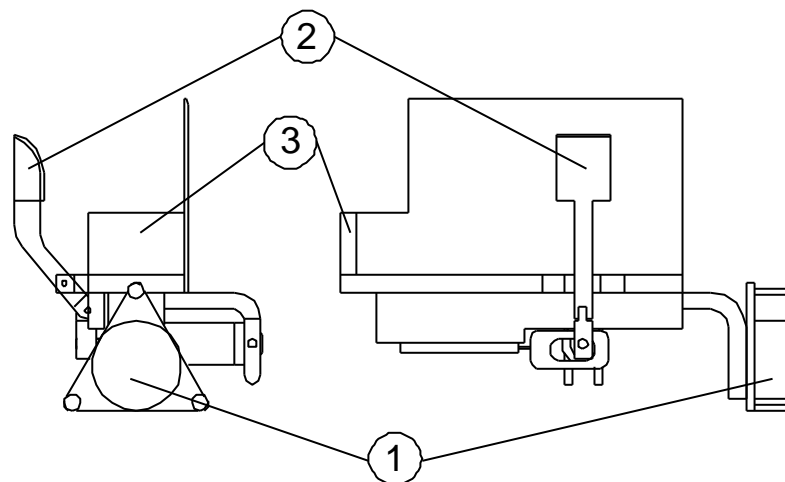

Figure 4.4 The book gripper viewed from the top (left) and from the side (right). (1) Tool changer interface, (2) pneumatic thumb for book grasping, and (3) book supporting shelf.

The book gripper is based on a pneumatic clamping device. The movements of the gripper's thumb are controlled by a double-acting pneumatic cylinder (diameter 16 mm). The gripper will hold a book with a force of 30 N, if the air pressure is set to 0,6 MPa (6 bar). The book grasped is supported by a small shelf to reduce the maximum clamping force needed. The approximate

friction coefficient of the surface of the thumb is 1 and the weight of the book gripper is 0.8 kg.

The design of the book gripper resulted mainly from the user requirement that the books be stored in a normal upright position and that the bookshelf look as normal as possible. These requirements have been met, with the exception that the books must be stored with space between each object. The width of these spaces must be at least 100 mm, which is the width of the book gripper when it is open. A photoelectric switch detects if a book is in the gripper.

The page turner is designed to open a books at any point and to turn pages forward or backward from that point. The page turner can also grasp papers and move them between the printer, the readerboard, the storage racks, and the input and output trays. The page turner is also designed to handle disks, as well as drinks served on a specially designed tray.

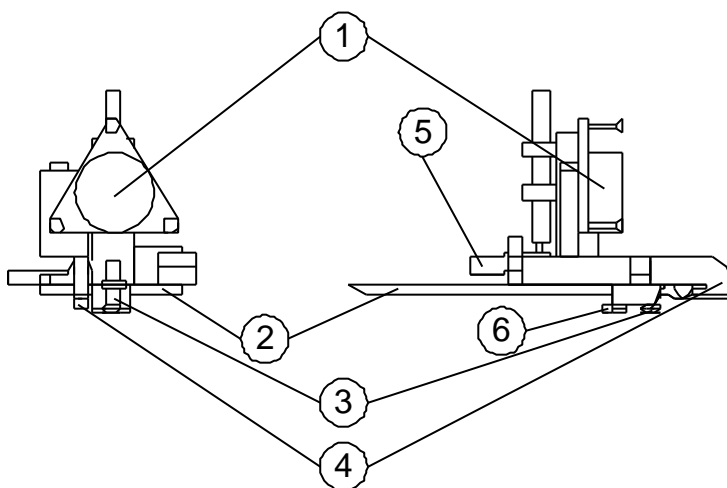

Figure 4.5 The page turner viewed from the top (left) and from the side (right). (1) Tool changer interface, (2) knife for turning multiple pages, (3) suction cup for lifting a single page, (4) clamp for grasping single pages, (5) clamp for paper handling, and (6) push button/switch for detecting page surface.

The three main parts of the page turner are a knife, a suction cup, and a clamping device placed close to the suction cup. The knife is a plastic plate the size of a human hand. It is used for opening books and turning multiple pages simultaneously. The suction cup and clamping device are used for single page turning. The bellow-type suction cup lifts a single page when it reaches the page surface. A push-button is mounted next to the suction cup and detects when the suction cup has reached the page surface. The activated push-button stops the approaching movement of the robot arm. The page is then lifted and grasped with the clamping device, which is connected to a double-acting pneumatic cylinder.

The readerboard has been designed to prevent small books from moving when they are opened and to prevent unwanted movements when pages are turned in small books with stiff pages. A big suction cup, placed in a hole in the readerboard, will prevent small books from moving. A finger has been added to the lower

part of the readerboard to press against the pages to prevent unwanted page movements. The finger is connected to a double-acting pneumatic cylinder, which is controlled by the robot. The finger is removed for a short time during the page turning process.

The knife is also used when handling papers (up to approximately 50 pages) and disks, and when serving drinks. The clamping force is produced by a single-acting pneumatic cylinder (6 mm diameter). The clamping device is activated toward the knife, which is used as a supporting surface for the papers, disks, and drink tray. A force of 15 N will hold the objects if the air pressure is set to 0.6 MPa (6 bar). The approximate friction coefficient of the surface of the clamping device is 1 and the weight of the page turner is 0.7 kg. A photoelectric switch detects whether an object is in the gripper.

The end-effectors are mounted on a robot tool changer, which makes it possible for the robot to change end-effectors automatically. The tool changer also increases the flexibility of the RAID workstation. New handling tasks, which may require a separate gripper, can then be added more easily. The possibility of adapting RAID to individual needs is an important user requirement.

It takes 60 s to move a book from the book shelf to the readerboard. It is expected that this can be reduced by 40% during an optimized work cycle. Grasping a book from the shelf has not caused any problems. When positioning soft catalogs on the readerboard, the robot has to carry out some extra movements to prevent the pages from bending. In addition, grasping a book from the readerboard has caused some difficulties with varying positions of the book in the gripper. However, this does not cause any problems when returning the book to the shelf, except in the case of catalogs, which have a tendency to bend.

When opening a book it is only possible to achieve an accuracy of +10 pages. To get to a specific page, the user then has to turn the pages one page at a time. The cycle time for turning one page is 15 s. In order to test the performance of the page turner at higher speed, the page turner was mounted and tested on an ABB Irb1000 industrial robot. The cycle time obtained with full functionality of the page turner was 3 s and approximately 100 pages could be turned without errors. Furthermore, in the case of an error, the robot could still proceed with the operation by turning backward or forward. Errors occurring during page turning were: 1) failure to lift and turn a page, 2) two or more pages turned at one time, or 3) an incomplete page turn. In all cases, a subsequent page turn without human interaction corrected any problems caused by the error.

At this stage, it is not possible to have one task program for all types of books. Our approach is to make one program for each book size. Furthermore, the tilt angle of the readerboard has to be specified. It is anticipated that the angle can be a parameter in the program. Page turning at the beginning and end of books causes some problems because the corners are not in the same position. Some user interaction may be needed during robot execution. The upper corners of stiff pages get slightly bent by the clamping device on the page turner. The vacuum ejector and pneumatic valves produce a certain amount of noise during operation. An electric vacuum pump was tested but rejected by the user.

Disk handling tasks have proven successful. Straight line interpolation and good robot repeatability are needed during this operation. However, the page turner is not ideal for this task because of geometrical constraints.

A special tray was adapted to the page turner in order to serve refreshments. No problems have occurred.

Results from User Trials

The first RAID prototype workstation has been evaluated by a group of potential users [18]. RAID was well accepted because it addresses an occupational need. The overall impression of the workstation was positive, in terms of both size and appearance.

The major concern of users was reliability of the robot tasks, e.g. turning pages in a pile of paper sheets and returning them to the storage compartment. Occasionally, the sheets were not aligned and fell on the floor. The users divided errors into two categories, recoverable and unrecoverable. A stapler not feeding a staple every time was considered a typical recoverable error. This task could be repeated by trying a second time. Paper sheets falling on the floor was considered as an unrecoverable error and was not accepted.

The end-effectors were found to be highly reliable in the paper and document manipulation tasks. However, the reliability of the tasks is not a function of the end-effector itself, but also includes the robot and peripherals. Therefore, necessary improvements were identified concerning the robot (motion control) and peripherals (document storage). An improved version of the RAID workstation is now undergoing evaluation at three rehabilitation centers in Sweden, France, and the U.K.

The user input device, integrating the wheelchair joystick with the computer, was part of the RAID prototype workstation. It resulted in a drastic decrease in typing speed compared to input devices normally used. Thus, the input device should not be a part of the RAID workstation but should be supplied by the rehabilitation center responsible for the installation. Only pre-

programmed tasks were evaluated. Large buttons were used to represent different robot tasks. The user interface was found to be easy to use and understand.

Further Development

Based on the results of the user trials, the RAID workstation will be further developed in a second stage with increased reliability and autonomy. Thus, the mechanical functionality of the end-effectors will be redesigned with respect to integration with the necessary sensors. Much work will be devoted to increasing the degree of flexibility and autonomy so that the workstation can operate in a less structured environment, as well as to developing process models for generic tasks, such as grasping different types of books and turning to specific pages.

The modularity of the workstation will also be improved to allow the user to specify the hardware and software components, e.g., the number of compartments in the bookshelf and automatic recognition of book sizes. In this context, users will be involved in the development of the workstation.

4.4.6 Walky – A Mobile Robot System for Rehabilitation

A mobile robot system is being developed for use in laboratory environments (typically chemical, medical and biological) by people with disabilities. This will widen the range of occupations open to people with physical disabilities, whose career opportunities are often limited to office type work. We have found three different areas which are suitable for robotization:

- Microscopy, for example cell examination and cell and chromosome counting.
- Blood group determination.
- Culture analysis.

Working Scenario

The system is intended for workplaces with varying workloads at different locations during normal work hours, such as hospital laboratories, where tests may come in batches that require different routines and equipment. A mobile robot may be well-suited to this kind of workplace, which uses different equipment and procedures that may take up to a few hours for each working session.

The robot task can be divided into two different problems – the mobility of the system and the robot operations involved in performing the specific tasks.

It is preferable to change as little as possible in the environment of the laboratory. Thus, the size of the mobile base has to be small enough to enable it to move around in a normal laboratory, as well

as to move through a doorway, etc. The robot tasks have been analyzed in order to adapt grippers and special tools, and to specify the working procedure for each task. From a user point of view, it is important to use the robot for manipulative tasks and to leave decision-making and analysis work to the individual.

Manipulator System

The mobile robot system consists of the following parts:

- Mobile base, LabMate (TRC), with sensor system (ultrasonic), including a local network.
- Five-axis robot, Scorbot ER VII.
- On-board computer and wireless modern communication link to main computer.

The robot is mounted on the mobile base, which is equipped with eight ultrasonic sensors, see Figure 4.6. The sensors are used to detect obstacles and to guide the robot into position for a new task. Safety aspects are taken care of by the ultrasonic sensors (software routine) and the bumpers on the LabMate. The on-board computer holds all necessary information for path planning and programs for different robot tasks and, if necessary, it can receive new information via a wireless modem.

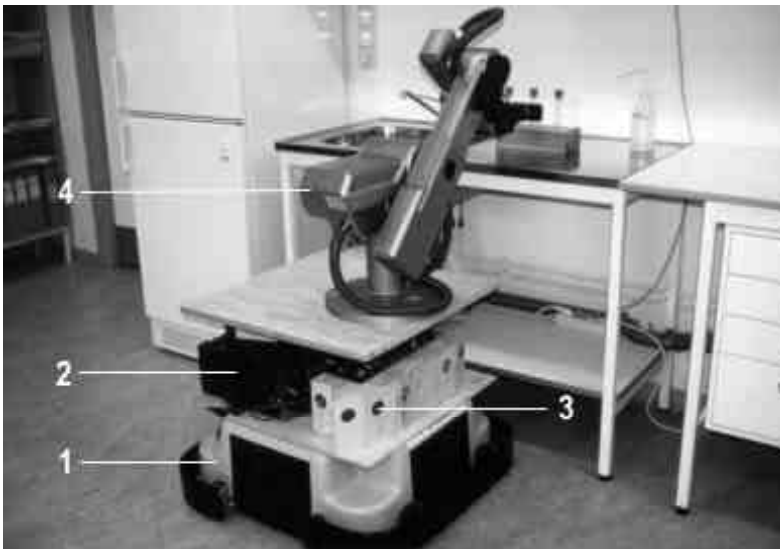

Figure 4.6 Walky mobile robot system with (1) mobile base, (2) on-board computer, (3) sensor system, and (4) robot manipulator.

Programming and Control

As with the RAID workstation, the Walky mobile robot system is designed to integrate with the user's own input devices, such as voice control or mouse emulation devices. These are normally connected to a computer via a serial line (COM-port on a PC) and, consequently, they are not used by the system for the purpose of interfacing with user devices.

In most cases, it is assumed that all working positions, equipment, walls, etc. are fixed and a map is created using simple objects (rectangles, circles, etc.), in a CAD-system. When the user wants to tell the system where to go, he or she picks a location on the map on the screen and invokes a path planning routine to generate a path between the two locations. In general, each object is associated with paths around it, which will be evaluated through a search routine to check if there is an object in between the start and stop locations. The method used is a combined depth-first and breadth-first search and picks the best-first solution to the problem. In case of unknown obstacles during run-time, a local path planning routine will take over to either guide the system back to an earlier position or around the obstacle. The path planner can be overridden by manually inserting the solution on the map as via-points.

Results and Future Work

Investigations in laboratories connected to Lund University Hospital show that there are several possible workplaces which are suitable for Walky. Various tasks have been analyzed and simulated for robot trials. The path planner for the mobile base was tested in an environment similar to that at its final destination. In order to cope with non-fixed objects, such as chairs, boxes, etc., the mobile base is equipped with a set of eight ultrasonic sensors for reactive planning. By utilizing the existing eight ultrasonic sensors in different configurations, trials on wall-following and detection of various obstacles (table leg, chair, book shelf, etc.) show that it is possible, in a partly known environment, to use ultrasonic sensors for collision avoidance and for guiding the mobile system. Results from trials show that small objects lying on the floor, doorsteps, table edges, etc. are difficult to detect. Consequently, it is necessary to increase the number of sensors in order to ensure a reliable system. Trials will be carried out in laboratories during 1995, and further developments needed will be defined based on the results of these trials. Future work will be directed toward increasing the level of autonomy for unstructured environments, such as home-based activities, and toward enabling two or more disabled individuals to share the same robot station for vocational tasks similar to those described with respect to the RAID station.

4.4.7 Concluding Remarks

Rehabilitation robotics is an emerging field with many connections to service robotics. However, special attention must be paid to the specific needs of individual users and their physical handicaps. Thus, each individual case must be carefully studied in

order to design and build a system which can be utilized by the user in an efficient manner. As described in this paper, much research has been devoted to mechanical design, including mobility and end-effectors, as well as programming and control. Much of this work is based on experience from industrial robotics. Although results are promising, it is important to recognize the need for research and development which is free from the influences of industrial robotics and which looks instead for functional specifications in service and rehabilitation robotics and how these can be transformed into technical solutions. This work, which is a part of new research currently underway at Lund University, will include advances in robotics design, including the use of reinforced composite materials and event-based programming with model representation to generate autonomous functionality. The utilization of such systems for rehabilitation and their human benefits may well be the starting point of a revolution similar to the one which began when the personal computer came on the market.

4.4.8 References

- [1] TIDE, *1993-1994 workplan*, Commission of the European Communities, 1993.
- [2] S.A. Napper and R.L. Seaman, *Applications of robots in rehabilitation*, *Robotics Autonom. Syst.*, vol. 5, pp. 227 - 239, 1989.
- [3] J. Hegarty, *Rehabilitation robotics: The user's perspective*, in Proc. 2nd Cambridge Workshop. Rehab. Robotics, Cambridge, U.K., Apr. 1991.
- [4] M. van der Loos, J Hammel and L. Leifer, *DeVar transfer from R&D to vocational and educational settings*, in Proc. 4th Int. Conf. Rehab. Robotics, Wilmington, DE, pp. 151 - 155, June 14 - 16, 1994.
- [5] T. Øderud, J.E. Bastiansen and S. Tyvand, *Experiences with the Manus wheelchair mounted manipulator*, in Proc. ECART 2, Stockholm, p. 29.1, May 26 - 28, 1993.
- [6] A. Casals, R. Villá and D. Casals, *A soft assistant arm for tetraplegics*, in Proc. 1st TIDE Congr., Brussels, pp 103 - 107, and *Studies in Health Technol. Inform.*, vol 9, IOS Press, Apr. 6 - 7, 1993.
- [7] R.D. Jackson, *Robotics and its role in helping disabled people*, *Eng. Sci. Educ. J.*, pp. 267 - 272, Dec. 1993.
- [8] J. Hennequin and Y. Hennequin, *Inventaid, wheelchair mounted manipulator*, in Proc. 2nd Cambridge Workshop. Rehab. Robotics, Cambridge, U.K., Apr. 1991.
- [9] S.Greenhill, *The digit Muscle*, *Ind. Robot*, vol. 20, no. 5, pp. 29 - 30, 1993.

- [10] S Levine, D. Bell and Y. Koren, *An example of a shared-control system for assistive technologies*, in Proc. 4th Int. Conf. Comput. for Handicapped Persons, Vienna, Austria, Sept. 1994.
- [11] J.-M. Détriché and B. Lesigne, *The robotized system for helping the disabled persons*, in Proc. IARP 2nd Wkshp. Med. Healthcare Robotics, Newcastle, U.K., pp. 19 - 41, 1989.
- [12] J.L. Dallaway, R.M. Mahoney, R.D. Jackson, and R.G. Gosine, *An interactive robot control environment for rehabilitation applications*, Robotica, vol. 11, pp. 541 - 551, 1993.
- [13] D.S. Lees and L.J. Leifer, *Experimental evaluation of a graphical programming environment for service robots*, in Proc. 4th Int. Conf. Rehab. Robotics, Wilmington, DE, pp. 19 - 23, June 14 - 16, 1994.
- [14] H. Neveryd and G. Bolmsjö, *Mobile robot system for disabled*, in Proc. ECART 2, Stockholm, p. 24.1, May 26 - 28, 1993.
- [15] H. Neveryd and G. Bolmsjö, *Walky, a mobile robot system for the disabled*, in Proc. 4th Int. Conf. Rehab. Robotics, Wilmington, DE, pp. 137 - 141, June 14 - 16, 1994.
- [16] G. Nikoleris, K. Brink, M. Olsson, and G. Bolmsjö, *Simplified programming of robots-Sport*, in Proc. Robotics Wkshp., Linköping, Sweden, p. B2, June 2 - 3, 1993.
- [17] M. Lindström, *Intelligent control of a mobile robot base*, Master's thesis, Dept. of Production and Materials Eng., Lund University, Lund, Sweden, May 1993.
- [18] C. Danielsson and L. Holmberg, *Evaluation of the RAID workstation*, in Proc. RESNA'94 Annu. Conf., Nashville, TN, pp. 451 - 453, June 17 - 22, 1994.

4.5 Specification of Robot Tasks

This section describes which objects RAID1 should be able to move and manipulate.

4.5.1 Objects

RAID1 should be able to handle all objects used in computer aided design work.

Books, Catalogues, Manuals and Binders

Size: Min 130 x 210 x 8 mm. Max 220 x 320 x 75 mm
(width x height x thickness)

Weight: Max 2 kg

Type: Hard and soft covers
Binders with and without plastic pockets

Paper Sheets

Size: A5-A4 and A3

Quantity: 1-100

Type: Single and double sided
Different paper qualities
Stapled and non-stapled

Example: Faxes, letters, data sheets, photographs, drawings, reports.

Floppy Disks (3½") and CD-ROM

Beverages

Type: Can, bottle and glass.

4.5.2 Moving Tasks

The following objects should be stored and presented in different positions at the workplace.

Books, Catalogues, Manuals and Binders

Move from input tray
Move to/from bookshelves
Move to/from readerboard

Paper Sheets

Move from printer
Move from input tray
Move to/from the left and the right sides of the readerboard
Move to/from paper trays
Move to/from stapler
Move to waste bin
Move to output tray

Floppy Disks (3½") and CD-ROM

Move from input tray
Move to/from disk storage
Move to/from disk drive
Move to/from CD storage
Move to/from CD player
Move to output tray

Beverages

Move to/from storage
Move to/from the user

4.5.3 Manipulation Tasks

RAID1 should be able to turn pages in books and in a pile of paper sheets and perform the following manipulation task. As a clarification, turning a page forward means that you will move closer to the end of the book.

Books, catalogues, manuals and binders

- Open the book at any point.
- Turn multiple pages forward and backward.
- Turn single pages forward and backward.
- Close the book.

Paper sheets

- Turn the whole pile of paper sheets forward and backward.
- Turn single paper sheets forward and backward.
- Move a paper sheet to the left or to the right on the readerboard.

4.6 Page-turning Developments

4.6.1 Development of End-effectors and a Readerboard for the RAID1 Robot

Appearance and Operation

Two pneumatically controlled end-effectors were developed for the RAID1: one book gripper and one page-turning gripper. The purpose of using two end-effectors was to ensure high reliability in the book-handling and the page-turning functions. The RAID1 end-effectors are described in Section 4.4.5: “The RAID Workstation and End-effector Design”. Supplementary descriptions, drawings and photos of the end-effectors and the readerboard developed for the RAID1 are provided below.

The principles governing page-turning were the same in RAID1 and RAID2, although many improvements were made to the RAID2. The robot is located behind and above the readerboard and it extends the end-effectors in front of the readerboard when handling books and documents, see Figure 4.7.



Figure 4.7 The robot places a book on the readerboard.

An important dimension in respect of the book gripper, see Figures 4.8 and 4.9, is the distance between the bottom edge of the book, upon which the gripper rests, and the “thumb” of the gripper, which holds the book. This distance (130 mm) determines the location of a rectangular opening in the surface of the readerboard. The opening is necessary in order to give space to the thumb of the book gripper when the robot puts the book on the readerboard. The size of the opening (height 85 mm, width

300 mm) depends on both the size of the thumb (height 30 mm) and the movements of the end-effector when putting down and picking up the book. If the top edge of the rectangular opening is located too high up, there is a risk that the top edge of a small A5-sized book (height 210 mm) will not be supported by the readerboard, and the book may fall through the opening in the readerboard. Consequently, I placed the upper edge of the opening 180 mm above the lower edge of the readerboard. Moreover, if the opening in the readerboard is too large there is a risk that an A4-sized paper will bend, and thereby impede page turning.

Page Turners

There are many important dimensions relating to the page-turning gripper, see Figures 4.10, 4.11, and 4.12. Two of these are the length of the “knife” (102 mm) used to open books and turn multiple pages and the distance from the point of the knife to the suction cup (189 mm) used for turning single pages. Large, A4-sized books and catalogues (height 297 mm) require a long knife capable of turning flexible pages, but not so long that the point of the knife catches on the bottom edge of the readerboard when the page turner is used for turning the pages of small A5-sized books (height 210 mm). The suction cup, located adjacent to the rear edge of the knife, must reach the top edge of a small book. The width of the knife is 90 mm. The thumb pressing against the knife is 23 mm long and 90 mm wide.

In order to make it possible to separate pages when turning single pages, a bellow-type suction cup was chosen (PIAB B10 $\text{Ø}_o=11\text{ mm}$, $\text{Ø}_i=4\text{ mm}$, $\Delta h=4,5\text{ mm}$), see Figure 4.13. The advantage of using a bellow-type suction cup is that a quick lift is obtained as soon as the suction cup reaches the page surface.

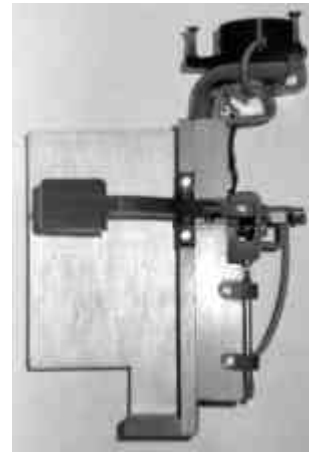

Figure 4.8 Side view of the RAID1 book gripper



Figure 4.9 Top view of the RAID1 book gripper

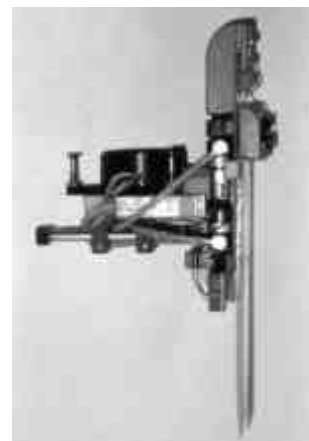

Figure 4.10 Side view of the RAID1 page-turning gripper

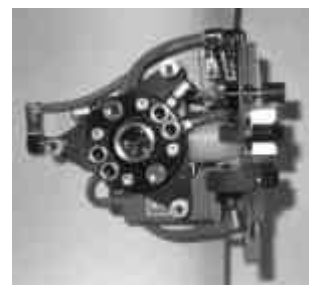

Figure 4.11 Top view of the RAID1 page-turning gripper

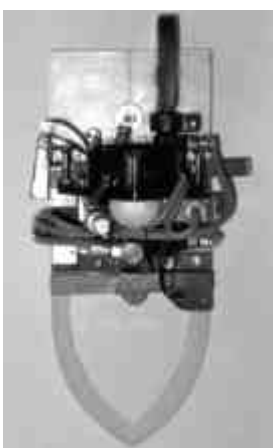

Figure 4.12 Front view of the RAID1 page-turning gripper



Figure 4.13 A bellow-type suction cup is used for page separation.

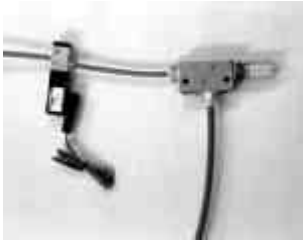

Figure 4.14 A compressed-air vacuum ejector is used for creating the suction in the suction cup.

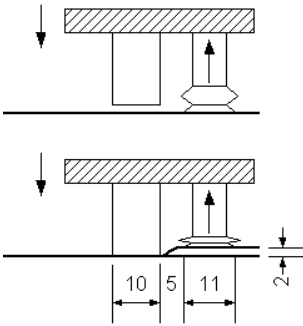

Figure 4.15 The page bends around a block when the suction cup contracts and lifts the page. This facilitates page separation.



Figure 4.16 The suction cup has lifted the page and the clamp is ready to grasp the page.



Figure 4.17 The clamp has grasped the corners of the page and the suction cup has released it.

The clamp holds the page during page turning.

In this regard, it is important to maintain a high airflow through the suction cup (>20 l/min), so that the suction cup will contract quickly, before being pressed against the book by the movement of the robot. Otherwise, there is a risk that the suction cup will lift more than one page. A high airflow is obtained by using a fairly powerful vacuum ejector (Festo VAD-1/8 pressure = +6 bar \Rightarrow vacuum flow = 21 l/min, vacuum level = -0,83 bar, air consumption = 47 l/min) see Figure 4.14. The vacuum ejector is connected to an air compressor (JunAir 6-S: max 8 bar, 50 l/min, air reservoir = 15 l, noise level = 45 dB (A)/1 m) with a pressure of 6 bar. A bellow-type suction cup with a small inner diameter is used so that the page will not be damaged by being sucked into the suction cup. A smaller diameter suction cup also reduces the lifting force of the suction cup, which is an advantage if it should happen to lift several pages at once. The additional pages can come loose during the subsequent page-turning movement. When the suction cup (PIAB B10) lifts a sheet of paper a vacuum level of about -0,45 bar is created, resulting in a lifting force of about 3 N.

A small block is located next to the suction cup to facilitate page separation. The distance between the edge of the block and the center of the suction cup is 11 mm and the height difference is 1.5 mm. When the suction cup reaches the page surface and contracts, the page bends around the block, see Figure 4.15.

The greatest bending effect is obtained when the suction cup lifts the page close to the corner of the page. The block also prevents the suction cup from pressing against the book. A push-button located at the same height as the suction cup is activated when the end-effector reaches the book surface, stopping the movement of the robot towards the book.

The end-effector must lift the page close to the corner in order for the clamp, which is designed to grip the edge of the page, to work properly. When the suction cup has grasped a page and lifted it, the clamp is activated and the suction cup releases the page. The clamp is used because it holds the page more securely during the page turning and because otherwise the air compressor might become overheated from overuse. Figures 4.16 and 4.17 show the operation of the clamp.

Drawings of the movement of the clamp are shown in Figures 4.18, 4.19, and 4.20.

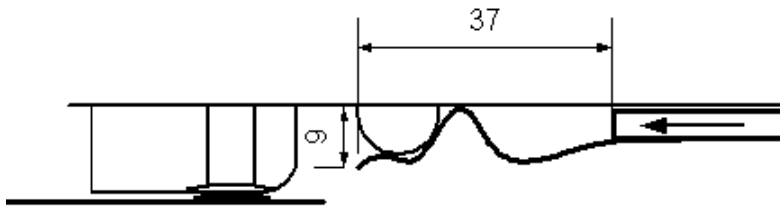

Figure 4.18 The clamp holding the page during page turning consists of a V-shaped leaf spring that can be moved back and forth.

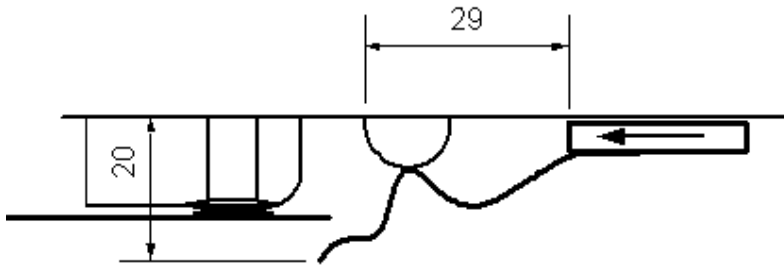

Figure 4.19 When the clamp is activated it moves around the page ...

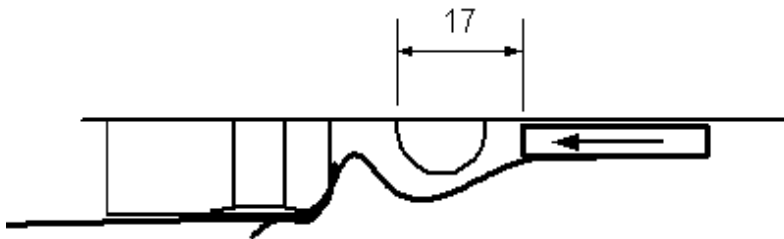

Figure 4.20 ... and grasps it.

Figure 4.21 shows a prototype of the RAID1 readerboard. The readerboard is designed to be used with the page turner and the book gripper. The width of the readerboard is 500 mm and the height is 276 mm to allow the robot to reach the top edge of an A4-sized sheet of paper when moving it from the readerboard.



Figure 4.21 A prototype of the RAID1 readerboard. The readerboard has functions which facilitate turning the pages of books.

A pneumatically controlled finger arranged at the lower edge of the readerboard ensures that the book stays open. The shape of the finger is a compromise. It must be wide enough to flatten the

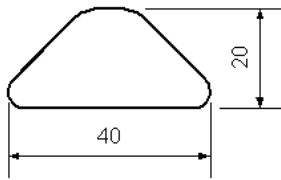

Figure 4.22 The finger of the readerboard must be narrow enough to fit between the pages and wide enough to flatten the pages when the robot has turned a page.

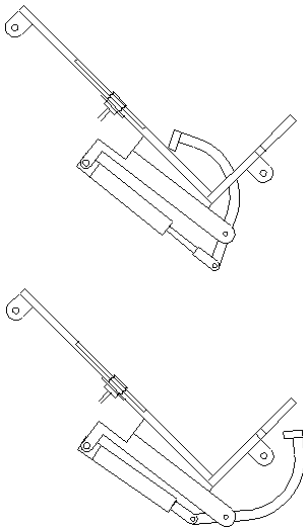

Figure 4.23 The finger holds the book open when the user is reading and is retracted for a short time during the actual page-turning movement.



Figure 4.26 An RT100 robot was used for testing the end-effector prototypes developed for RAID1.

pages, making the book easy to read, but narrow enough to fit between the pages when the robot has turned a page and avoid pressing down on the next page. Figure 4.22 shows the shape of the finger and Figure 4.23 shows the movement of the finger. A curved bar is mounted at the center of the lower edge of the readerboard to prevent the pages from catching on the edge when the robot turns multiple pages.

A large bellows-type suction cup (PIAB B20: $\varnothing_o=22$ mm, $\varnothing_i=12$ mm, $\Delta h=10$ mm) on the right-hand side of the readerboard holds the back cover of the book in place when the book is being opened, when several pages are being turned at the same time, and when the book is being closed. The suction cup is located in the rectangular opening in the readerboard, 138 mm from the lower edge of the readerboard and 120 mm to the right of the center of the table, in order not to interfere with the thumb of the end-effector. The suction cup extends about 3 mm from the surface of the readerboard to enable it to reach the back cover of the book. The book is held in place using a force of about 10 N by means of a vacuum ejector (Festo VAD-1/8: pressure = +6 bar \Rightarrow vacuum flow = 21 l/min, vacuum level = -0.83 bar, air consumption = 47 l/min). The vacuum ejector is connected to a compressor of 6 bar pressure.

Prototypes of the two end-effectors, see Figures 4.24 and 4.25 and the readerboard were first tested using an RT100 robot similar to the one used in the RAID project, see Figure 4.26. In these initial trials, it was possible to test the operation and accessibility of the end-effector, see Figures 4.27 and 4.28.



Figure 4.24 A prototype of the RAID1 book gripper.



Figure 4.25 A prototype of the RAID1 page turner.



Figure 4.29 The operation of the page turner was tested at high speeds using a fast industrial robot (IRb1000 from ABB).



Figure 4.30 Various turning movements were tested. The end-effector is rotated while turning a page.



Figure 4.27 The book gripper grasping a book in a compartment in the bookshelf.

The Division of Robotics at Lund University used a fast industrial robot (IRb1000 from ABB) to ensure that the operation of the page-turning gripper was satisfactory even at high speeds, see Figures 4.29 and 4.30. Video sequences of these tests can be seen at <http://www.certec.lth.se/doc/useworthiness/>.

Page-turning Movements

The following is a description of the RAID1 page-turning movements. For the benefit of the reader, the video sequences of RAID2 page-turning movements are available on the Internet: <http://www.certec.lth.se/doc/useworthiness/>. The page-turning movements of RAID2 are similar to those of RAID1.

The knife of the page turner is used in opening the book. Tests have shown that the best place for the knife of the page turner to cut into the book is at the upper corner. At the corner, the knife can be inserted without folding the pages. Next, the suction cup of the readerboard holds the back cover of the book in place, while the robot effects a circular movement and rotates the blade of the knife through about 30°, see Figure 4.31. When the book is open, the finger of the readerboard is activated to hold the pages apart. The robot then moves to the waiting position at the upper edge of the readerboard.

The same movement is used for moving forward several pages at a time and the corresponding movement is used for going back several pages at a time. To prevent the pages of large A4 catalogues from folding in connection with multiple page turning, a separate program is used for large books and catalogues. In this program the page-turning gripper holds the pages during the entire turning movement, which means that the circular movement has to be exact.



Figure 4.28 Putting the book on the readerboard.



Figure 4.31 The end-effector has opened the book and the finger of the readerboard is holding it open.

When closing a book, the finger of the readerboard is retracted and the knife of the end-effector is inserted between the top left-hand corner of the book and the readerboard, after which a circular movement is effected to close the book. Even if this circular movement does not close the book completely, the book gripper is capable of gripping the book on the readerboard. The suction cup of the readerboard is activated in connection with the circular movement to ensure that the left part of the book turns to the right and does not fall forward towards the reader instead – a problem can occur when the left part of the book is much heavier than the right part, i.e. when the book is open to one of its last pages.



Figure 4.32 To begin turning a page, the robot moves the suction cup of the page-turning gripper towards the upper right-hand corner of the book.

The page-turning movement of a single page can be divided into three steps:

Separating and lifting a single page.

Turning the page.

Preventing additional pages from turning and flattening the pages of the book.



Figure 4.33 The movement towards the book stops when the push-button adjacent to the suction cup is pressed. The bellow-type suction cup has lifted a page a couple of millimeters.

When separating the pages, the robot places the suction cup of the page turner about 50 mm from the upper corner of the page, activates the vacuum of the suction cup, and begins a straight-line movement towards the surface of the readerboard, see Figure 4.32. The movement stops when the robot receives a signal from a sensor (the push-button adjacent to the suction cup) or when it reaches the surface of the readerboard, see Figure 4.33. The suction cup contracts and the robot lifts the page about 20 mm, after which a clamp grips the page and the suction cup releases it.

The robot releases the finger of the readerboard and turns the page using a circular movement, during which the page turner is always parallel to the readerboard. Accordingly, the page-turning gripper does not rotate when turning single pages. The page can follow this movement in two ways, both of which are satisfactory.

The page can either be turned first at the inner edge, see Figure



Figure 4.34 A page can begin turning at its inner edge in a U-shaped movement ...



Figure 4.35 ... or at its outer edge in an S-shaped movement.

4.34, or close to the outer edge, see Figure 4.35. The first alternative is used mostly for small, narrow books and the second alternative is more common with large, wide books. The worst that

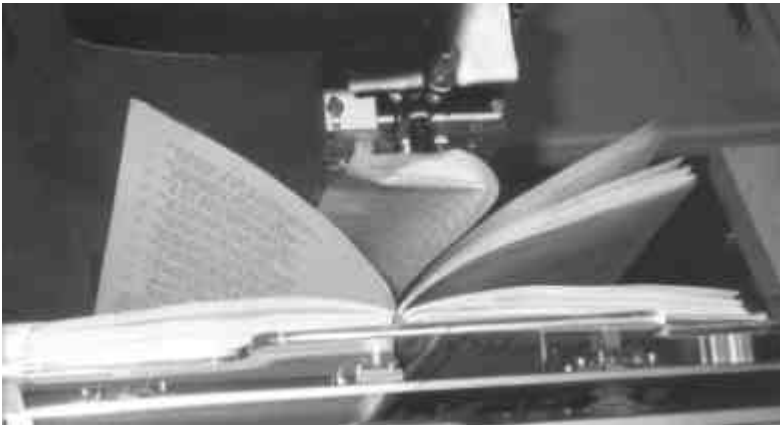

Figure 4.36 If there is a crease in the page the page turning may be more difficult.

can happen is that a page can become wrinkled as a result of the turning, see Figure 4.36.

To enable the finger of the readerboard to fit more easily between the page that has just been turned and the next page (which also tends to turn), the robot can finish the circular movement about 10 mm lower down, i.e. closer to the lower edge of the readerboard. This 10 mm movement in the vertical direction moves the lower corner of the page about 40 mm in the lateral direction, i.e. to the left when turning pages in the forward direction, see Figures 4.37 and 4.38. This feature can be used so that the robot will not be required to turn the page as far, thus reducing the risk that the next page will also be turned.

In connection with the activation of the finger, the robot releases the page and returns to the waiting position. The finger ensures that the pages are kept apart so that the user can read the text. In addition, the finger pressing against the book counteracts the tendency of the book to close when turning the next page.



Figure 4.37 There is a risk that the finger of the readerboard will hit the page that is being turned.



Figure 4.38 By moving the upper corner of the page downwards at the end of the turning movement, the lower corner of the page is moved to the left, making room for the finger of the readerboard.



Figure 4.39 To quickly move to the last page, the entire sheaf of papers can be turned onto the left-hand side of the readerboard.

When turning A4-sized sheets of paper, the suction cup lifts the paper at the upper edge of the sheet instead of at the corner. The clamp grasps the sheet and lifts it, and the end-effector rotates through 180°, placing the sheet on the left-hand side of the readerboard. In this way, it is possible to read double-sided sheets.

When an entire sheaf is to be turned, the knife and the thumb are used in the same way as when a sheaf of papers is moved, for example, from the printer to the readerboard. This function reduces the time required for leafing through the pages to get to last page of the sheaf, see Figure 4.39.

Since it is necessary for the suction cup and the clamp to grasp the upper edge of a page and because the page-turning movement is different for different books, a separate program is needed for each book whose pages the robot is to turn.

The user cannot choose where the book will be opened, but when several pages are to be turned at the same time, the robot stops with the knife of the page turner at the upper corner of the book and displays a menu. At this point, the user can adjust the position of the end-effector to enable the knife to cut into the corner of the book at the right place. The user chooses the number of millimeters he wants the knife to move towards or away from the readerboard. When the user clicks the OK button the page-turning movement continues.

4.6.2 Results from RAID1

Reliability of RAID1 Tasks

The following tasks was excluded from the RAID1 workstation because they were impossible to perform or because of limited project time:

- A3-sized paper sheets. These could not be positioned on or grasped from the readerboard, because of the limited reach of the robot. They could not be turned because of the shape of the readerboard.
- Page turning in more than one book.

In order to reach as high reliability as possible during the RAID1A user trials, the page turning performance of the RAID1 workstation was evaluated and a number of books were recommended.

The books in Table 4.1 were selected for the RAID1A user trials and were therefore used in this reliability test.

Because of the problems stated below, only books 5 and 6 were analyzed in detail. However, books 2, 3 and 8 were also analyzed. All these five books were recommended for the RAID1A trials.

No.	Book type	Width x Height x Thickness (mm)	Title
1	Paper back (A5)	148 x 210 x 11	JET Datorhandboken
2	Paper back	188 x 226 x 25	Windows User manual
3	Paper back (A4)	210 x 297 x 8	Black Box catalogue
4	Ring bound	196 x 222 x 13	Quickmail manual
5	Hard bound	133 x 211 x 22	Dikt och tanke
6	Hard bound	168 x 246 x 20	Rehabilitation Technology
7	Hard bound	217 x 300 x 20	Bra Böcker Läkarexikon
8	Binder (A4 Swedish)	260 x 314 x 60	
9	Binder (A4 Swedish)	260 x 314 x 40	

Table 4.1 These books were selected for the RAID1A user trials.

The RAID1 workstation was difficult to program as a result of an unreliable direct mode. Several times the robot continued to move until the end stop even though the button that moved the robot had been released. Another problem caused the robot to stop in the middle of a single page turning process when a sensor was monitored. Each time any of these problems occurred, the robot and the computer had to be reset and initialized again.

So far, it has been possible to turn the pages of all types of books. However, page turning at the beginning and at the end of books and closing a book when you are at the end of the book has sometimes been difficult. The test specification and results for books 5 and 6 and a pile of A4 paper sheets are documented in Appendix A. Here are some results for each book.

At first, it was difficult to program the book-opening task for book 2. The knife was too short and dropped the pages when the robot opened the book and when multiple pages were turned. Therefore, no test results can be presented for book 2.

However, when programming the book opening task for book number 3, a new book opening method was used. The clamp on the knife was used to hold the pages while the robot opened the book. This method worked for the book opening task as well as for turning multiple pages in book 3 and it should work for book 2 as well. The backward single page turning task for book 3 has not yet been tested. It was not possible to return book 3 to the book shelf compartment. The pages were folded when the book entered the compartment. Modifying the robot program or to the book support in the book compartment might solve the problem. The paper back catalogue used in this test was old and had been used a great deal.

Books 5 and 6 could not be closed when you were at the end of the book. The suction cup on the readerboard did not hold the book, because it did not reach the back cover of the book. The user had to turn multiple pages backwards before the book could be closed. Book 5 turned over when multiple pages were turned

backwards at the end of the book. This task was only attempted once. The single page turning tasks for book 5 was not tested.

Forward single page turning at the end of book 6 was unreliable as the initial approaching movements of the knife of the page-turning gripper turned a couple of extra pages.

The following tests were carried out with the Swedish binder of type JOPA, see Figure 4.40. The binder contained an index (A - Z)

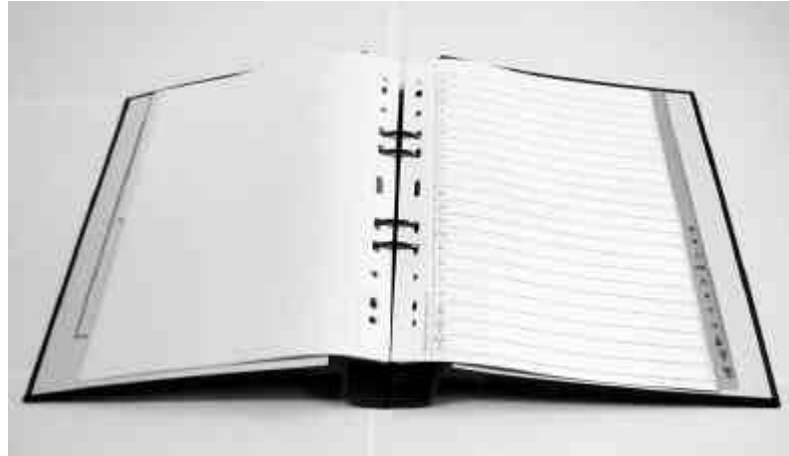

Figure 4.40 The Swedish binder of type JOPA.

with five A4 paper sheets inserted at each index letter. The weight of the binder was 1.3 kg, which did not cause any problems.

Another opening method was used for binders, where only the front cover of the binder was turned. No failures occurred. Closing the binder caused some problems. The binder moved to the right between 4 and 35 mm. 4 mm when it was closed from index letter K and 28 and 35 mm when it was closed from index letter T and U. The binder could still be grasped from the readerboard, but it might not have been possible to return it to the book shelf. This could not be tested, because the wider compartments in the lower bookshelf have not been added to the robot program. The same multiple page turning method was used as the one used for book 3. Seven trials, no failures. Only forward page turning was tested. Forward single page turning was tested 34 times (from index letter F until M). In 6 of these turns, two or more pages were turned instead of one. When turning pages at the end of the binder (at index letter U) no pages were lifted. The back cover of the binder was tilted, causing the push button to stop the suction cup from reaching the page surface.

Turning pages in a pile of A4 paper sheets back and forth a number of times resulted in a non-collated 220-235 mm wide pile instead of the original width of 210-215 mm. The guides on the paper storage compartments should be able to cope with this inaccuracy. The paper sheets had to be dropped the last 50 mm onto the readerboard because of the design of the page-turning gripper and the readerboard. The 100 g/m² paper quality is recommended for the RAID1A trials, because the width never

exceeded 235 mm. Furthermore, most of the tests were carried out using this paper quality. In two thirds of the tests the width exceeded 235 mm for 80 and 160 g/m² paper qualities.

In order to be able to turn pages in hard back and paperback books of varying height and width, seven page turning programs are needed. Binders need a separate page turning program. Hence, a total of eight page turning programs are needed.

In order to be able to turn single pages in books of different sizes (height varying between 210 and 300 mm), seven different page-turning programs are needed. The height difference is 90 mm and one page turning program allows a height difference of 13 mm. The page turning program for the Rehabilitation Technology book (height 246 mm) was able to turn pages in books that were between 239 and 252 mm high. For smaller books, the suction cup on the page-turning gripper hit the page above the top edge of the page. For larger books the suction cup lifted a page, but the clamping device could not grasp it. Less than seven programs would be needed, if the clamping device was not used, but the reliability of the page turning procedure would then decrease.

The page turning programs were not as sensitive to width differences. The width difference for the books evaluated is 84 mm (widths varying between 133 and 217 mm) and one page turning program was able to cope with a width difference of 40 mm. The page turning program for the Rehabilitation Technology book (width 168 mm) was able to turn pages in books that were between 158 and 198 mm wide.

Time Required for RAID1 Tasks

The time to execute the RAID1 tasks is presented in Table 4.2. The time does not include movements to and from the waiting position.

<i>Tasks</i>	<i>Time</i>
Open book	18 s
Single page turning	15 s
Multiple page turning	27 s
Close book	18 s
Single sheet turning	24 s
Multiple sheet turning	21 s

Table 4.2 Time required for RAID1 tasks.

4.6.3 Development of End-effectors and a Readerboard for the RAID1A

Appearance and Operation

For the RAID1A version, Oxford Intelligent Machines Ltd adapted the two end-effectors for production by integrating them into a



Figure 4.41 The RAID1A page turner is capable of moving books to and from the readerboard as well as turning pages. In this way, the time-consuming change-over from book gripper to page turner is avoided.

single end-effector, a page turner, which in addition to page turning can also be used for moving books and documents to and from the readerboard. In this way, the robot can begin turning pages as soon as the book is placed on the readerboard, avoiding time-consuming tool changes, see Figure 4.41.

The page turner is no longer used for handling diskettes. Instead the standard end-effector of the robot is used, making diskette handling more reliable.

The new page turner for RAID1A has an electrically controlled “thumb” capable of pressing sufficiently hard on the page-turning knife to grasp sheets of paper as well as books. The electrical control enables it to adjust the opening of the end-effector depending upon, for example, the size of the book compartment. A bar with a friction surface is mounted at right angles to the page turner knife to provide additional support for books, thereby ensuring that they will be held firmly in place by the end-effector. The page turner knife is 135 mm long and 90 mm wide and the thumb is 85 mm long and 40 mm wide.

The end-effector bar comprises the pneumatic functions for turning single pages, i.e. a suction cup and a clamp, but the clamp cannot not be used because of its design. Instead, the suction cup is used to hold the page throughout the page-turning movement. The block which was mounted adjacent to the suction cup of the RAID1 and which was used for separating pages has been eliminated from the page turner of the RAID1A. A smaller vacuum ejector (Koganei ME03: pressure =+6 bar => vacuum flow=3.0 l/min, vacuum level=-0.83 bar, air consumption=4.5 l/min) is mounted on the end-effector instead of the powerful vacuum ejector used for the RAID1 page turner. The RAID1 air compressor has been replaced by one that is cheaper but much noisier. The mechanical push-button which sensed when the suction cup contacted the book in the RAID1 version has been replaced by a vacuum sensor.

To enable the robot to use both the page turner knife and the bar with the suction cup, the interface of the end-effector changer is mounted at a 45° angle to the knife and the bar.

Integrating the end-effectors and adapting them for production was not entirely successful. The 45° angle and the fact that the page turner knife and the bar with the suction cup was located at right angles to each other made it was more difficult to identify the limit positions of the robot in connection with programming, and it also meant that the angle of the readerboard had to be exactly 45° to make it possible to turn single pages as well as multiple pages. If the readerboard was placed at any other angle, one of the functions could not be used.

The main difference between the readerboard of the RAID1 and that of the RAID1A is that the latter is made of transparent plastic to give the user a better view of the bookshelf and the diskette compartments. The width of the readerboard is 500 mm and the height is 230 mm. The opening in the readerboard is 64 mm high, 300 mm wide and its upper edge is located 207 mm from the lower edge of the readerboard. The bellow-type suction cup of the readerboard, which holds the back cover of the book, is located 106 mm from the lower edge of the readerboard and 106 mm to the right of the center of the readerboard.

Page-turning Movements

The principle governing page separation was changed from that of the RAID1. When “open book” is selected, the end-effector holds the cover of the book during the page turning, see Figure 4.42. Since the block adjacent to the suction cup of the page turner has been eliminated, there is a greater risk that the suction cup will lift several pages. The fact that the vacuum ejector is smaller further increases that risk. Consequently, a couple of new page-separating movements were introduced to ensure that only one page would stay in the suction cup. One way of separating the pages is to turn the vacuum of the suction cup off and on when one or several pages have been lifted. Another way is to move the suction cup 10 mm down towards lower edge of the readerboard and back again before turning the page.

Menus

Since the clamp adjacent to the suction cup could not be used, it was no longer necessary to grasp the upper edge of the page for geometrical reasons, see Figure 4.43. Accordingly, it was sufficient to use two page-turning programs, one for large books and one for small books. This was one of the reasons why the clamp was not corrected.

Users can finish making their selections on the RAID1A menu before the robot begins to carry out the movements. If, for example, the robot has been changing diskettes using the standard gripper, it does not start changing to the page-turning gripper until the user has selected both “turn the pages of a book” and “one page forward”.

When the robot is used for opening a book, the user can make precise adjustments to the position of the end-effector in the same way as in connection with multiple page-turning, i.e. the end-effector positions itself at the corner of the book and the user selects from a menu the number of millimeters the knife blade of the end-effector should be moved forwards or backwards before being inserted into the book.



Figure 4.42 When opening the book, the end-effector holds the cover in place.



Figure 4.43 In order to minimize the number of page-turning programs, the suction cup lifts the pages of some books somewhat lower down. The finger of the readerboard contacts the book before the page is released.

4.6.4 Results from RAID1A

Reliability and Time Required for RAID1A Tasks

The reliability and the time required for the RAID1A tasks have been measured at the RAID workstation at the Department of Rehabilitation in April 1995, see Table 4.3.

<i>Tasks</i>	<i>Time, including waiting pos.</i>	<i>Time, excluding waiting pos.</i>	<i>Reliability</i>	<i>Number of attempts</i>
Single page turning	26 s	12 s	91 %	113
Multiple page turning	52 s	22 s	74 - 88 %	111
Single sheet turning	45 s	20 s	4 - 83 %	159
Multiple sheet turning	64 s	21 s	100 %	30

Table 4.3 Reliability and time required for RAID1A tasks, see Appendix B.

A large part of the total task execution time is spent on movements to and from the waiting position of the robot arm. Therefore, the task execution time is presented including and excluding the movements to and from the waiting position.

- Only one book type was tested: “Rehabilitation Technology” (TIDE1 proceedings), hard back, height 246 mm, thickness 20 mm. Paper quality: not rough, not glossy. Paper thickness: 0.07-0.12 mm/page)
- When turning multiple pages, sometimes a few additional pages were turned. If this is considered to be an error, the reliability is 74 %, otherwise it is 88%.
- The reliability when turning single pages depends on the paper quality.
- Paper type used for A4 sheets:
 - Stora Papyrus, Cyclus Copy 141.081 “RAID paper”, weight 90 g/m²
 - Stora Papyrus, Multi Laser 154.063 (429 189), weight 75 g/m²
 - SCA, Wifsta Office Premium, 7391649750153, weight 80 g/m²
- Most of the unrecoverable errors occurred when turning sheets of “non-RAID” type. Three unrecoverable errors occurred when turning single pages 100 times in RAID type sheets.
- The most common errors were:
 - The suction cup did not separate pages.
 - Additional pages turned by themselves.
 - The book was not held flat, causing pages to be folded when they were grasped and causing the finger to hit the subsequent pages.

4.6.5 Development of End-effectors and a Readerboard for the RAID2

Appearance and Operation

In the page-turning gripper of the RAID2, a binary, infrared sensor has been installed adjacent to the suction cup (detection distance 4 mm) to measure the height, width, and thickness of the book, thereby making it possible to determine the location of its upper right-hand corner. A parametrically structured page-turning program has been developed which can handle A5-sized as well as A4-sized books.

The sensor is used for turning single as well as multiple pages. The sensor detects the current thickness of the book, i.e. how many pages have been turned, thereby making it easier for the user to select the correct number of pages.

The orientation of the page-turning knife and the location of the suction cup and the page-separating block are similar to the RAID1. The distance between the edge of the block and the center of the suction cup is 11 mm and the height difference is 1.5 mm. However, the clamp has been eliminated and, consequently, the suction cup holds the page during the entire turning movement, just like the RAID1A. The same kind of vacuum sensor as the one used in the RAID1A is used to stop the movement of the suction cup towards the page when turning single pages.

To improve page separation, the small vacuum ejector used in RAID1A has been replaced by a somewhat larger one (Koganei ME05: pressure=+6 bar => vacuum flow=6.3 l/min, vacuum level= -0.87 bar, air consumption=11.5 l/min) and an air outlet with an adjustable flow control valve has been mounted 40 mm from the center of the suction cup. The air flow from the air outlet (approx. 35 l/min) is directed so that it will strike the edges of a page just before the suction cup reaches the surface of the page. Measuring the corners of the book not only improves the page-turning movement, it also improves page separation since the suction cup can be placed close to the corner of the page, where the block adjacent to the suction cup is most effective. The same air compressor is used as in the RAID1A.

The electrically controlled thumb for pressing against the knife blade has been moved to the other side of the knife blade. In this way, a book can be carefully lifted from the table with full control regardless of the thickness of the book. The fixed knife is introduced through the opening in the readerboard behind the book and the movable thumb then grasps the front of the book, see Figure 4.44. In the RAID1A, only the thumb of the page turner was required to fit in the opening in the readerboard. To make it



Figure 4.44 The RAID2 can lift a book from the readerboard very carefully because the movable thumb of the end-effector grasps the front of the book.

possible to enlarge the opening only slightly, the knife blade of the RAID2 is only 70 mm wide.

The knife of the page turner has been extended so that the upper parts of the end-effector adjacent to the robot do not catch on the upper edge of the readerboard when the robot opens a small book or turns multiple pages of a small book. The reason is that it is necessary to rotate the end-effector in connection with these movements. The length of the knife is 160 mm. The distance from the point of the knife to the center of the suction cup is 185 mm. The thumb pressing against the knife is 120 mm long and 40 mm wide.

To sum up, the page turner of the RAID2 uses a knife blade, a gripping thumb, an infrared sensor, an air outlet, a suction cup with a vacuum sensor, and a page-separating block.

4.6.6 The Readerboard

The height of the readerboard has been increased to 300 mm so that A4-sized sheets of paper will not bend around the edge of the readerboard. The readerboard has also been made wider – width 600 mm – to eliminate the risk of the knife blade ending up behind the readerboard when the robot is closing a book. The opening in the readerboard has been enlarged and is now 90 mm in height to accommodate the knife blade of the page turner. The opening has also been extended to the left to allow enough room for the extended knife blade of the page turner behind the book on the readerboard when a book is being moved. The distance between the upper edge of the opening and the lower edge of the readerboard is 200 mm, which means that the upper edge of a small A5-sized book (height 210 mm) is supported by the readerboard. In addition to the suction cup on the right-hand side of the readerboard, a large suction cup has been mounted on the left-hand side of the readerboard to hold the front cover of the book when several pages have been turned towards the back of the book. The distance between the center of the suction cups and the center of the readerboard is 105 mm and the center of the suction cups is located 90 mm above the lower edge of the readerboard.



Figure 4.45 The RAID2 readerboard has been provided with two additional clamps for flattening the pages of the book. Two brushes are mounted on the lower edge of the readerboard to prevent the robot from turning too many pages.

Two additional clamps (width 30 mm) have been mounted on the readerboard to improve the flattening of the pages, thereby making it easier to read the book see Figure 4.45. In multiple page turning, the clamps are also used to press the cover of the book towards the suction cup of the readerboard. The finger at the lower edge of the readerboard is used to separate the pages sufficiently to allow the clamps to satisfactorily flatten the pages. The distance between the center of the clamps and the center of the readerboard is 105 mm.

To prevent the robot from turning more pages than intended when turning multiple pages, two small brushes have been mounted on the lower edge of the readerboard. The brushes project approx. 10 mm from the edge and are located 50 mm from the center of the readerboard. Only the pages which the robot turns are moved past the brushes. This reduces the problem of too many pages being turned forward at the end of a book and too many pages being turned backwards at the beginning of a book.

The readerboard was manufactured by Oxford Intelligent Machines Ltd from the dimensioned sketches, descriptions of readerboard functions, and prototype I produced, see Figure 4.46.

To sum up, the RAID2 readerboard uses a finger, two clamps, and two suction cups for holding the book against the readerboard. In addition, two brushes mounted on the lower edge of the readerboard to prevent too many pages from being turned.



Figure 4.46 A prototype of the RAID2 readerboard.

Page-turning Movements

Video sequences of the RAID2 page-turning movements are available on the Internet:

<http://www.certec.lth.se/doc/useworthiness/>.

When a book is placed on the readerboard, the lower left-hand corner of book is always in the same position regardless of the size of the book. Accordingly, the corner, which is located closest to the surface of the readerboard, is used a reference point for calculating the thickness (T), height (H) and width (W) of the book.

The page-turning gripper, which is equipped with a binary, infrared sensor, is used for the measuring movements. The coordinate system of the end-effector is used for calculating the measurements and the end-effector is parallel to the surface of the readerboard during the measuring. The x-axis is perpendicular to the surface of the readerboard, the y-axis extends to the left from the point of view of the user, and the z-axis is aligned with the end-effector.

The measuring movements of the robot are carried out when the “Open book” alternative has been chosen from the menu, but before the book is opened. The robot assumes that the smallest book size is A5 and places the infrared sensor in front of the upper right-hand corner of the book. The clamp on the right-hand side of the readerboard holds the cover of the book during measuring.

The thickness of the book is measured by starting a straight-line movement towards the book, which is interrupted when the sensor detects the front cover of the book. This position is saved and compared with the known position of the lower left-hand corner of the book at the surface of the readerboard. The difference between the x coordinates of these points equals the size



Figure 4.47 The infrared sensor has detected the upper edge of the book. This position is used in calculating the height of the book.



Figure 4.48 When the robot has measured the thickness, height, and width of the book it places the tip of the end-effector at the upper right-hand corner of the book to confirm that the measurement is correct.

of the book. In multiple page turning, the sensor is used to detect the remaining thickness (t) of the book.

The height of the book is measured by the robot moving the sensor even closer to the surface of the book and starting a movement towards the upper edge of the book. When the sensor detects the upper edge of the book, the movement is interrupted and the position of the robot is saved, see Figure 4.47. The difference between the z coordinate for this position and the z coordinate for the reference point equals the height of the book.

The same method is used for measuring the width of the book. The robot places the sensor close to the surface of the book and starts a movement to the right, towards the edge of the book. The movement is interrupted and the position is saved, the difference between the y coordinate of the saved position and the y coordinate of the reference point equaling the width of the book.

The values for the height, width, and thickness of the book are added to the reference point to calculate the position of the upper right-hand corner of the book. Finally, the robot positions itself at the top right-hand corner of the book to confirm that the measurement is correct, see Figure 4.48. The values measured are saved and used for subsequent page-turning operations until the user instructs the robot to open a new book.

When opening a book, the robot uses the specific measurements of the book to enable it to open the book in the right place. The circular movement is then carried out in the same way for all book sizes, but the position where the user has chosen to open the book affects the circular movement.

When the alternative “Open book” has been selected from the menu and the user has chosen how much to open the book, the robot starts its measuring movements to calculate where the upper right-hand corner of the book is located. Subsequently, the robot positions the point of the knife blade of the page-turning gripper 35 mm to the right and 10 mm below the corner of the book. The distance to the readerboard is determined by how much the book should be opened, i.e. the remaining book thickness (t). The knife blade is introduced at the corner of the book to a position 110 mm to the right of and 150 mm above the lower left-hand corner of the book, see Figure 4.49. (This position is the same for all books.) The movement is parallel to the surface of the readerboard. In this position, the pages are held in place, the right-hand clamp of the readerboard release the pages, the suction cup is activated to hold the back cover of the book, and a circular movement is performed. The circular movement ends at a point where the end-effector has rotated 90° and is located at the center of the readerboard at a distance of $110 \text{ mm} + \text{the remaining book thickness}$ from the surface of the readerboard, see Figure 4.50.

Starting point: (t, -110, -150, 0, 0, 0), where t is the remaining book thickness.
 Intermediate point: (t+ 78, -78, -152, 0, 0, 55)
 End point: (t+110, 0, -152, 0, 0, 90)

The three first parameters denote the position (x, y, z) and the last three parameters denote the orientation of the end-effector, i.e. the rotation around the three axes. The change in the z value (from -150 to -152) means that the robot lifts the cover of the book 2 mm during the movement to ensure that the cover does not catch on the lower edge of the readerboard. (the x, y and z coordinates refer to the lower left-hand corner of the book).

In this position, the clamp on the right-hand side of the readerboard is activated and the vacuum of the readerboard is turned off. The robot continues to open the book to a 145° angle, i.e. (t+78, 78, -152, 0, 0, 145), at which point the finger of the readerboard is introduced between the pages of the book. The robot releases the book, the clamp on the left-hand side of the readerboard is activated, and the finger is retracted.

When a single page is to be turned in the forward direction, the robot uses the values for the height, width, and thickness of the book which were measured in connection with opening the book.

It places the suction cup of the page-turning gripper in front of the upper right-hand corner of the book. The vacuum function and the air outlet are activated and the suction cup is moved towards the surface of the page 55 mm to the left of and 15 mm below the upper right-hand corner of the book, see Figure 4.51.

The movement is interrupted when the vacuum sensor of the suction cup detects that the suction cup has lifted the page. The air outlet is turned off and the readerboard finger is retracted, after which the page turning is carried out by means of a circular movement, see Figure 4.52. (It should be noted that the x, y and z coordinates refer to the upper right-hand corner of the book.)

Starting point: (t-T, 55, 15, 0, 0, 0)
 Intermediate point: (W/2, W, 15, 0, 0, 0)
 End point: (T+W/3, W+50, 25, 0, 0, 0)

where t is the remaining book thickness, T is the thickness of the book and W is the width of the book.

When the circular movement has been completed, the readerboard finger and the right-hand clamp are activated. The vacuum of the suction cup is turned off and the knife blade of the page turning gripper flattens the page that has just been turned.



Figure 4.49 The page turning gripper is designed to open books from the same position regardless of the size of the book.



Figure 4.50 When the robot opens a book, the brush on the lower edge of the readerboard prevents it from turning too many pages. In this position, the clamp on the right-hand side of the readerboard grips the book before it is opened wider.



Figure 4.51 Air is blown towards the upper edge of the book to separate the pages when turning a single page.



Figure 4.52 When the robot turns a page, the page-turning gripper carries out a circular movement. The brush on the lower edge of the readerboard stops the subsequent page from turning. In this position, the finger of the readerboard is moved towards the book.

Menus

Only one program is required for all book sizes from A5 to A4 because a sensor measures the height, width, and thickness of the book and these measurements are used as parameters in the page-turning program.

It has been possible to simplify the page-turning menu by using a sensor for measuring the thickness of the books. When a user wants to open a book, he indicates how many per cent of the thickness of the book the robot should open. The alternatives given are 10%, 20%, and so on. This solution is based on the assumption that we usually talk about opening a book at the beginning, the middle, or the end, and these expressions relate to the thickness of the book.

The sensor is also used in multiple page turning forwards or backwards, but in that case a menu is displayed asking the user how many millimeters he wants to move from the current position. (Percentages are not used since this can lead to misunderstandings about whether they refer to the total number of pages or the number of remaining pages of the book.)

The reason why the menus ask the user for the number of millimeters instead of the number of pages, which would seem more natural, is the assumption that the robot will be seen as more reliable if it carries out the user's commands correctly. If, for example, the user commanded the robot to turn 30 pages, corresponding to approx. 3 mm, and the robot turned 40 pages, the robot would be making an error. However, if the user estimates how many millimeters 30 pages represent and commands the robot to turn 3 mm and the robot should happen to turn 40 pages, the robot has carried out the operation correctly since it has turned 3 mm, just as the user commanded. This compromise results from the fact that with the present page-turning method, the robot is not capable of sensing exactly how many pages it will turn.

4.6.7 Results from RAID2

Summary of User Comments

The trials showed that the reliability of a robot is important – more important than speed. Moreover, a distinction should be made between the errors users can correct on their own and errors which someone else must take care of. If the robot does not succeed in turning a page on the first attempt it is always possible to try again, but if the robot should happen to drop a few documents on the floor, for example, that is more serious. The robot is reliable when handling A4 paper and diskettes, but it is not as reliable when turning the pages of books. The characteristics of the books are

important. New books with soft covers are the most difficult, while it is easier to turn the pages of well-read hard cover books.

The speed of the robot is not particularly important. What is important is how long it takes to pick up a sheet of paper from the printer and put it on the readerboard or how long it takes to open a book to a specific page. The time required depends both on the speed of the robot and on the distance between the printer and the readerboard. The total time a user must spend waiting for the robot during a workday also depends on how often he needs to pick up papers from the printer. Consequently, the efficiency of the robot depends on the type of work the user does. When this is known, the efficiency of the robot can be increased by placing printers, paper compartments, etc. in the best possible locations.

It is difficult to find a suitable location for the printer, the readerboard, and the book, paper and diskette compartments. The test users stated that they want to be able to see what the robot is doing at all times. Consequently, the readerboard and the book and paper compartments were made of transparent plastic, but papers lying on the readerboard may block the user's view of, for example, the printer and the diskette compartments. If these are located farther away, the handling tasks will take longer to complete. The final result must be a compromise between visibility, size, and efficiency.

Reliability and Time Required for RAID2 Tasks

The reliability and the time required for the RAID2 tasks were measured at the RAID workstation at the Department of Rehabilitation in May 1996, see Table 4.4. Only the RAID2M version (Master software) was used, since there was insufficient time to program all the robot movements of the RAID2C (CURL software). The reliability was measured as percentage of successful attempts for the following tasks:

<i>Tasks</i>	<i>Time</i>	<i>Reliability</i>	<i>Number of attempts</i>
Book collection	75 s	100 %	26
Measure book	51 s	100 %	5
Single page turning	53 s	40 - 100 %	97
Multiple page turning	80 s	100 %	23
Sheet(s) collection	48 s	100 %	18
Document collection from printer	76 s	100 %	2
Discarding documents	57 s	100 %	2
Stapling	69 s	0 %	4
Single sheet turning	53 s	70 - 100 %	38
Multiple sheet turning	51 s	100 %	8
Diskette collection and insertion	55 s	100 %	12
Drink collection and presentation	100 s	100 %	4
Tool changing	87 s	100 %	6

Table 4.4 Reliability and time required for RAID2 tasks.

- The reliability of the RAID2 workstation when turning single pages or sheets depends on the paper quality. Often, more than one page or sheet is turned and sometimes the page-retaining finger on the readerboard hits the page that has been turned.
- For some tasks very few attempts were carried out. However, for these tasks no problems occurred during the user trials.
- Because of the vertical position of the stapler, it does not work every time even if the sheets are inserted manually.

When turning multiple pages in books the user selects how many millimeters the robot will cut into the book. One millimeter corresponds to approximately ten pages. Before the robot gripper cuts into the book the remaining book thickness is measured. There is a reliability problem for the user when the surface of the page is not quite flat: the thickness detecting sensor detects the page surface “too early”, causing only a few pages to turn. This also affects the time required to reach the desired page in a book.

When opening a book the user selects at what percentage he wishes to open it. When opening hard covered books at 10%, the robot gripper sometimes hits the front cover of the book because of the thickness of the cover. This will sometimes cause an unrecoverable error, if the user does not stop the robot and tries again.

Reliability and Time Required for the RAID2M versus the RAID1A

The reliability of the RAID2M is higher than the reliability of RAID1A, see Table 4.5.

<i>Tasks</i>	<i>Reliability of RAID2M</i>	<i>Reliability of RAID1A</i>
Book collection	100 %	100 %
Measure book	100 %	not included
Single page turning	40 - 100 %	91 %
Multiple page turning	100 %	74 - 88 %
Sheet(s) collection	100 %	95 %
Document collection from printer	100 %	100 %
Discarding documents	100 %	100 %
Stapling	0 %	0 %
Single sheet turning	70 - 100 %	4 - 83 %
Multiple sheet turning	100 %	100 %
Diskette collection and insertion	100 %	100 %
Drink collection and presentation	100 %	100 %
Tool changing	100 %	100 %

Table 4.5 Reliability of the RAID2M compared with the RAID1A. RAID2M comes out on top.

There are some differences between the total task execution time for the RAID2M and the RAID1A, but the total time is almost the same: 804 s compared to 796 s, see Table 4.6 and Figure 4.53.

Task	Task time	Pause time	Total time	Total time
	RAID2M	RAID2M	RAID2M	RAID1A
Book collection	50 s	25 s	75 s	96 s
Single page turning	35 s	18 s	53 s	26 s
Multiple page turning	54 s	26 s	80 s	52 s
Sheet(s) collection	30 s	18 s	48 s	50 s
Document collection from printer	51 s	25 s	76 s	105 s
Discarding documents	39 s	18 s	57 s	67 s
Stapling	44 s	25 s	69 s	102 s
Single sheet turning	34 s	19 s	53 s	45 s
Multiple sheet turning	32 s	19 s	51 s	64 s
Diskette collection and insertion	37 s	18 s	55 s	71 s
Drink collection and presentation	72 s	28 s	100 s	56 s
Tool changing	63 s	24 s	87 s	62 s
Sum	541 s	263 s	804 s	796 s

Table 4.6 Time required for RAID2M tasks compared to RAID1A tasks.

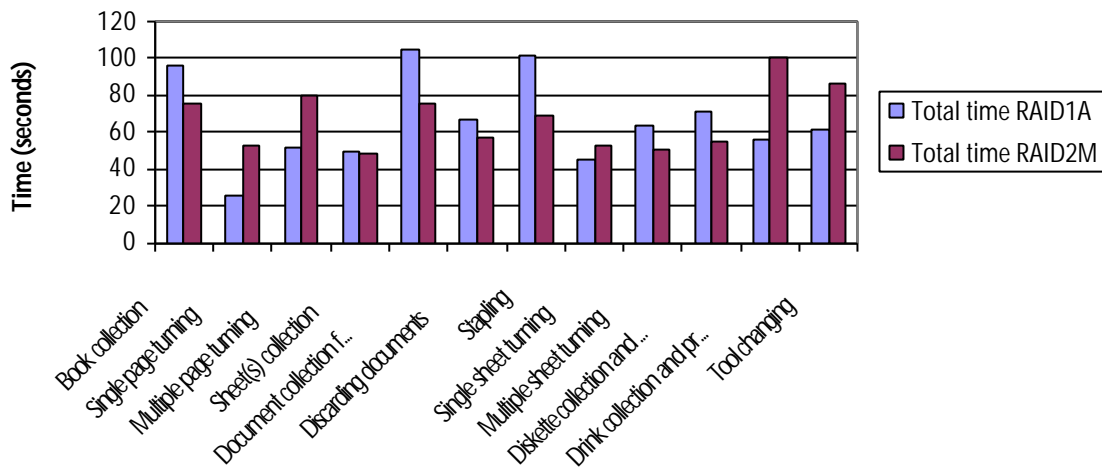

Figure 4.53 Total time required for RAID1A and RAID2M tasks.

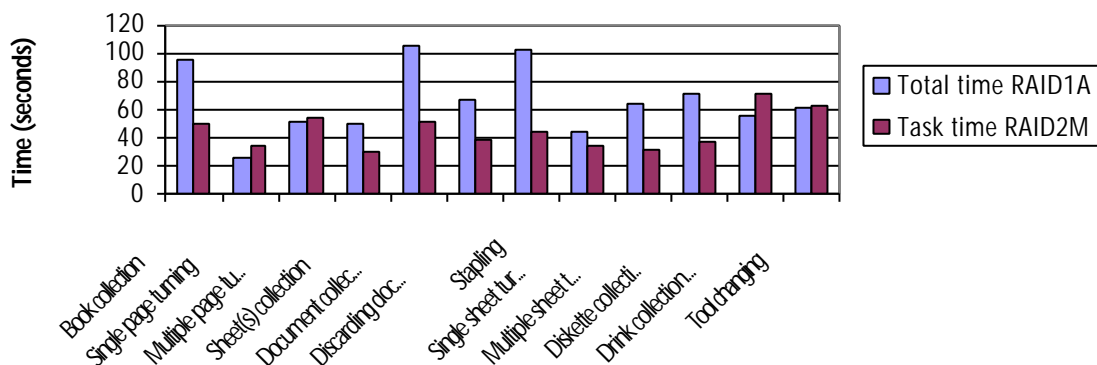

Figure 4.54 Total time required for the RAID1A compared to the task time for the RAID2M. In this diagram the pauses in the RAID2M have been removed.

In RAID2M there is a two-second pause after each robot movement. These pauses were introduced by mistake and they are not part of the task programs. However, they account for 33% of the total task execution time for RAID2M ($263 \text{ s} / 804 \text{ s} = 0.33$).

If the pauses between the robot movements in the RAID2M are removed, the time required for executing the tasks with the RAID2M is 32% shorter compared to the RAID1A ($541 \text{ s} / 796 \text{ s} = 0.68$), see Figure 4.54.

The longer task execution times for single and multiple page turning in books are due to the additional robot movements to flatten the page after it has been turned. These flattening movements are not always necessary and an experienced user can separate them from the page turning task and invoke them only when needed. This saves about 20 seconds. Prior to multiple page turning in the RAID2M the remaining thickness of the book is measured, which takes about 30 seconds. Because of the accuracy problem when turning multiple pages, it could take a long time to reach the desired page in a book.

The drink task has not been optimized at all in the RAID2M. Therefore, the time required for this task is much longer than for the RAID1A. The task was given a low priority compared with tasks that are carried out more frequently.

The tool changing task takes longer in the RAID2M because the column of the robot was moved, which was not the case with the RAID1A.

Section 4.7 has been published in the Proceedings of the Fourth International Conference on Rehabilitation Robotics, ICORR, pp.97-101, Wilmington, Delaware, USA, June 1994.

4.7 Robot Control Methods and Results from User Trials on the RAID Workstation

Håkan Efrting

Certec, Center for Rehabilitation Engineering Research, Lund University, Sweden

4.7.1 Abstract

Certec intends to develop an autonomous grasping function, but first user requirements have to be studied.

Therefore, user trials have been carried out on the RAID workstation (Robot to Assist the Integration of the Disabled) at the Rehabcentrum Lund-Orup in Höör, Sweden, see Figure 4.55. This paper will describe the control methods used in these trials as well as the results of the trials.



Figure 4.55 The RAID workstation.

4.7.2 Introduction

The flexibility of a pre-programmed robot is sometimes too low from the user's point of view, because the disabled user can only perform pre-programmed tasks.

One way to increase the flexibility is to control the robot in manual mode. Unfortunately, controlling a six-axis robot in manual mode is often very time consuming and increases the cognitive load on the user. The most difficult part, when controlling the robot in manual mode, is to control the final, small grasping movements of the robot arm.

An autonomous grasping function can hopefully decrease both the cognitive load on the user and the time needed to grasp an object. The user would then only have to move the robot gripper to the vicinity of an object and then start the autonomous grasping function.

Additionally, an autonomous grasping function will make it possible to program the robot without teaching accurate positions. This will make it easier for disabled users to program the robot themselves.

Before an autonomous grasping function is developed, it is important to study the user requirements. The following questions will be discussed in this paper:

- How close to an object can the users manually control the robot gripper within a specified time limit and by using different control methods?
- At what distance do the users want to start the autonomous grasping function?
- How much help do the users get from a TV monitor showing the robot gripper from a different angle?

User trials have been carried out on the RAID workstation (Robot to Assist the Integration of the Disabled) at the Rehabcentrum Lund-Orup in Höör, Sweden. The RAID workstation is described in [1]. This paper will describe the control methods used in these trials as well as the results of the user trials.

4.7.3 Control Methods

At the user trials two tetraplegic users controlled the RAID workstation in various ways. Both users are able to use a mouse emulating joystick to control the cursor on the screen and to control the robot in manual mode. The users click with the joystick by pressing it down. One of the users controls the joystick with his chin, see Figure 4.56.

Automatic Mode – Shelf Number

During the RAID project only pre-programmed tasks were used and the user addressed a book by its shelf number. For example, if



Figure 4.56 One of the users controlling the joystick with his chin.

the user wanted to move a book from shelf number 11 to shelf number 12, the following menu alternatives were selected:

- Menu 1: BOOK
- Menu 2: FROM SHELF 11
- Menu 3: TO SHELF 12

One of the aims with the following user trials was to educate the users in different robot control methods. During the user trials the menu tree in Figure 4.57 was used. Here, the user can move a book, by using two different addressing methods: Shelf numbers or book titles. The task above would require the following menu alternatives in these trials:

- Menu 1: SHELF NUMBER
- Menu 2: FROM SHELF 11
- Menu 3: TO SHELF 12

Automatic Mode – Book Title

In the first part of the trials, the users also addressed a book by its title. A very simple database was updated automatically when the robot moved a book. For example, if the user wants to move the green binder to an empty shelf, the following menu alternatives are selected, see Figure 4.57:

- Menu 1: BOOK TITLE
- Menu 2: GREEN BINDER
- Menu 3: TO EMPTY SHELF

The database will find the shelf number of the green binder and an empty shelf, where it places the binder. If more than one shelf is empty, the robot will place the binder in the shelf with the lowest number.

The users were shown what happened when a book was borrowed and returned to another shelf. In this case the database was incorrect, which caused the robot to make a grasp in the air. To be able to grasp the moved book, the users had to update the database using the NEW POSITION alternative in the main menu, see Figure 4.57.

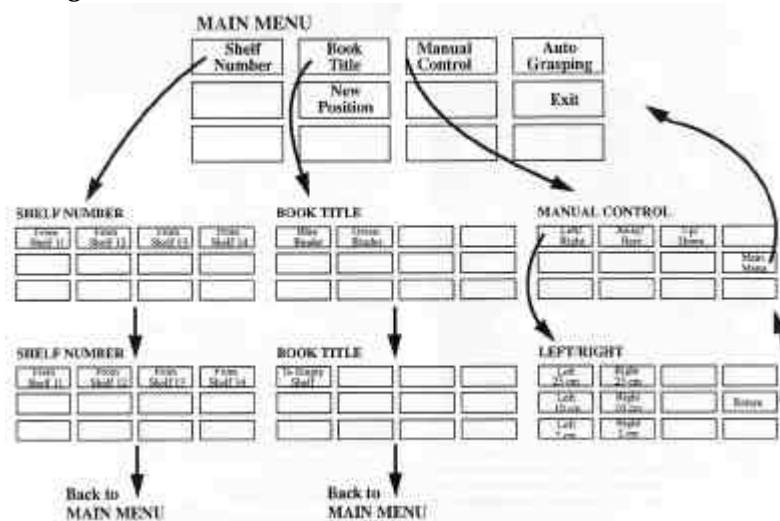

Figure 4.57 Menu tree used during the user trials.

Manual Mode

In the second part of the trials the users controlled the robot in manual mode. Manual mode was needed to be able to grasp a binder positioned on a table outside the book shelf, see Figure 4.58.

To control the robot in manual mode, the users tried both the joystick for continuous movements and an xyz menu for incremental displacements of 25, 10 and 2 cm. In these manual modes, the users only had to control the position of the robot (x, y, z), not the orientation (yaw, pitch, roll).

Instead of x, y and z, the user was prompted for left/right, away/here and up/down, all relative to the user, see the menu tree in Figure 4.57.

When using a two-degree of freedom joystick, the user had to switch between controlling the robot in the xy plane and along the z axis. The joystick manual mode is included in the French MASTER 2 system, which was used during these trials.

The robot starting position was: (200, 660, 1150)

The position of binder 1 was: (440, 730, 765)

The position of binder 2 was: (440, 590, 765)

This means that the robot gripper was 240 mm to the right and 385 mm above the two binders, from the user's point of view. The distance between the centers of the two binders was 140 mm. The distance to the user was approximately 2 meters. A technical description of the book gripper can be found in [2].

A video camera was directed towards the table with the two binders. The view was displayed on a TV monitor standing beside the computer monitor during the trials, see Figure 4.59.

When the video camera was turned on, the users could see the table, the binders and the robot gripper from the side view, helping the users when controlling the robot along the away/here line.

Manual Mode and Autonomous Grasping

In the third part of the trials a simulated autonomous grasping function was invoked by the users, when the gripper was in the vicinity of a book, see Figure 4.60. The distance from the gripper to the book was measured when the users invoked the autonomous grasping function.

4.7.4 Results

Automatic Mode – Shelf Number

It was difficult for the users to see the shelf numbers of the books. One of the users would like to have a small piece of paper attached to the screen, to be able to remember the shelf numbers of the



Figure 4.58 Manual mode was needed to be able to grasp a binder positioned on a table outside the book shelf.



Figure 4.59 A video camera was directed towards the table with the two binders. The view was displayed on a TV monitor standing beside the computer monitor during the trials.



Figure 4.60 A simulated autonomous grasping function was invoked by the users, when the gripper was in the vicinity of a book.

books. The database has this function, acting like a small piece of paper inside the computer.

Automatic Mode – Book Title

The users liked this way of addressing a book, because they did not have to see the shelf numbers of the books.

When a book was borrowed and returned to the wrong shelf, causing the robot to make a grasp in the air, the users wanted to correct the robot by addressing the book by its shelf number instead of its title. This just temporarily solved the problem. The database was still incorrect. The users did not ask how they could update the database, but they were shown how to do it.

Manual Mode – XYZ Menu

The time to control the robot from the starting position until a binder had been grasped was approximately 8 minutes, using the xyz menu. 75 % of this time was due to the menu response time, i.e. the time delay before the robot movement had started and before the new menu had appeared on the screen.

The time to grasp a binder was reduced to approximately 4 minutes when the users repeated the trials. The users began to remember the displacements to select in the menus.

The TV monitor did not reduce the grasping time. One of the users wished to have the video camera mounted above the table, showing the top view of the binders.

Manual Mode – Joystick

Using the joystick to control the robot, the time to grasp a binder was 2 minutes down to 1 minute. The time the users had to wait for the menus was approximately 25 % of this time.

Manual Mode and Autonomous Grasping

The gripper position just outside the back of the binders is 100 mm to the right of the grasping positions. Therefore, the positions, where the users invoked the autonomous grasping procedure, are measured to the following binder positions:

Binder 1: (340, 730, 765)

Binder 2: (340, 590, 765)

Using the xyz menu, the users started the autonomous grasping function when the distance to the back of the binders was approximately 50 mm. The time to reach this position was approximately 3 minutes. 75% of this time was menu waiting time.

When the users used the joystick, they first had 40 seconds to move as close to the back of the binders as they could. The final distance was 50 to 90 mm with an average of 75 mm.

Including menu delay:
XYZ Menu: 3:00 + 5:00 = 8:00
Joystick: 0:40 + 1:20 = 2:00

Excluding menu delay:
XYZ Menu: 0:45 + 1:15 = 2:00
Joystick: 0:30 + 1:00 = 1:30

Table 4.7 The approximate grasping times when controlling the robot in manual mode in minutes and seconds. Rough positioning time + fine positioning time = total grasping time.

When the users only had 20 seconds to move the robot, the final distance was 60 to 160 mm with an average of 95 mm.

4.7.5 Conclusions

The TV monitor, showing the robot gripper from another angle, did not reduce the grasping time. The reason for this could be the difficulties to distinguish the gripper clearly from a messy background, but when the TV monitor was turned off the users were unsure of themselves. Tests with the camera mounted above the table and on the robot arm should be carried out.

The users liked the simulated autonomous grasping function, mainly because of the reliability of this function compared to manual mode, but also because of the short grasping time, 13 seconds including menu delay, and 6 seconds excluding menu delay. However, a real autonomous grasping function will probably be slower.

The autonomous grasping function should be able to find and grasp an object from a distance of 100 mm. This position could be reached by the users in approximately 30 seconds using either xyz menus or a joystick.

When objects are smaller than binders and positioned closer to each other, the autonomous grasping function could have difficulties to find the correct object. Further user trials should be carried out with objects of different sizes.

4.7.6 Acknowledgements

I would like to thank the RAID partners for developing the RAID workstation, the Swedish foundation Stiftelsen för bistånd åt vanföra i Skåne for funding this project and last but not least the users for their participation.

4.7.7 References

- [1] J L Dallaway, R D Jackson
RAID – A Vocational Robotic Workstation
Proceedings of ICORR 92,
Keele University, UK, 1992.
- [2] G Bolmsjö, H Efrting
RAID, Robotic end-effector developments
Proceedings of the 1st TIDE Congress,
pp. 108-112, Brussels, Belgium, 1993.

5 User Trials of the Manus Manipulator

5.1 The Manus Manipulator as a Tool for Rehabilitation

5.1.1 Abstract

A National Rehabilitation Robotics Center has been established at the Department of Rehabilitation at Lund University Hospital. At the Center, people with severe physical disabilities, such as high-level spinal cord injuries, have the opportunity to try out the RAID workstation and the wheelchair-mounted Manus manipulator during their rehabilitation.

Between May 1997 and May 1998, eight individuals tested the Manus manipulator for carrying out various tasks. In this article we present the results of these trials and of the practice sessions with one of the users, who bought her own Manus manipulator in November 1998.

The purpose of the trials was to establish whether and how robotic devices can be used at an early stage in the rehabilitation process as a means of increasing user motivation for further rehabilitation.

The test users were able to choose the tasks they wanted to perform, but the final step in the trials consisted of the following compulsory task: opening a kitchen cupboard, taking out a glass and putting it on a table, closing the cupboard, opening a refrigerator, taking out a pitcher of water from the refrigerator, pouring water into the glass, putting the pitcher back in the refrigerator and closing the door.

The test users stated that they probably would not have wished to try the Manus too soon after their injury. In a survey, five out of six users answered that it is a good to have the opportunity to try out robotic aids before being discharged. All six believed that it is important to receive information about the availability of robotic aids at an early stage.

Only one of the test users would have liked to have a Manus manipulator that looks and works like the present version. The rest thought it was too big, too heavy, and too difficult to use. On the other hand, four of the users would have liked to have a Manus manipulator if it were improved in some way. Six users answered

Section 5.1 will be published as an article in the Scandinavian Journal of Rehabilitation Medicine.

In all essentials this article was written in collaboration with Kerstin Boschian, occupational therapist, and Dr Bengt Sjölund, both of the Department of Rehabilitation, Lund University Hospital, Sweden.

that the Manus would make them more independent and improve their quality of life.

Half a day is sufficient for someone to learn how to use the Manus, but one or two additional half-days are required to become familiar enough with the robot to avoid most beginner's mistakes. In three half-days, the user has sufficient time to carry out a large number of tasks and familiarize himself with the robot. However, it takes two to three weeks to become a skilled user and to make the adjustments necessary for practice sessions in more realistic conditions.

5.1.2 Introduction

Increasingly, robotic arms are used as assistive technology for people with severe physical disabilities (16, 18). The Department of Rehabilitation at Lund University Hospital and Certec at Lund University have been collaborating in the field of robotics since 1993, when the RAID workstation was evaluated in an EU project (2, 4, 7).

Our collaboration led to the creation of a National Robotics Center in the Department of Rehabilitation at Lund University Hospital. At the Center, people with severe physical disabilities – high-level spinal cord injuries for example – are given the opportunity to try out various robotic aids during their rehabilitation. The Center bought a wheelchair-mounted Manus manipulator (11, 20) in connection with its opening in 1996. Patients who have not been admitted to Lund University Hospital can obtain a referral to the Center. Other interested individuals who have a physical disability may try out the robotic aids if they can arrange external financing. A survey shows that occupational therapists are interested in learning more about robotic aids in rehabilitation (5, 8).

Between May 1997 and May 1998, eight individuals tested the Manus manipulator for carrying out various tasks. In this article we present the results of these trials and of the practice sessions with one of the users, who bought her own Manus manipulator in November 1998.

The purpose of the trials was to establish whether and how robotic devices can be used at an early stage in the rehabilitation process as a means of increasing user motivation for further rehabilitation. Would patients become more motivated if they were able to experience early on how robot technology can compensate for neurological loss and thus lead to greater independence (10, 13, 15)? Can robot technology create more opportunities for meaningful activities and thus increase user motivation for further rehabilitation?

5.1.3 Methods

Preliminary discussions with three individuals with high-level spinal cord injuries, two of which had previous experience of robotic aids, were aimed at determining what tasks would be suitable for carrying out with the aid of the robot. This would in turn determine the choice of robot. In a number of earlier studies, the choice of task was left to the user (17, 19).

Choice of Robot

The following robots were possible choices: the Manus manipulator from the Netherlands (11, 20), Helping Hand from the United States (9), RoboArm (Hugh McMillan myoelectric arm) from Canada (9) and Handy 1 from Great Britain (3).

Our requirements were that it should be possible to use the robotic arm when carrying out the following tasks (not in order of priority): changing a videotape, a CD, or a diskette; taking books from a bookshelf and turning the pages; changing the paper in a printer; picking up objects from the floor; opening the mail; drinking; answering the phone in bed; opening doors; picking up a pillow; pressing buttons; and moving objects, such as shoes, which block the path of a wheelchair.

User safety was of the utmost importance when selecting a suitable robotic arm. Experience from the evaluation of the RAID workstation (4), for example, indicates that technical reliability is important in user trials. Consequently, it was essential to select a robot with a proven record.

The advanced, commercially available, Manus ADL robot was chosen in preference to the other alternatives since it meets most of the above requirements. In addition, the Manus manipulator was a finished and tested product (14, 21), which reduced the risk of technical problems during the user trials. Handy 1 can only be used for a small number of tasks (eating, washing, shaving, and applying make-up). Helping Hand and RoboArm were new products and had not been sufficiently tested.

The Manus manipulator is a wheelchair-mounted robotic arm controlled by means of a keypad or a joystick. In certain cases it can be controlled by means of a joystick on the wheelchair. It has a range of about 80 cm and it can lift just over 1 kg. When the Manus is not in use it can be folded away at the side of the wheelchair or be unhooked from the wheelchair.

The Manus manipulator was mounted on a Permobil Max90 electric wheelchair. In order to make it possible to mount the Manus on the wheelchair a mounting plate was manufactured and bolted to the seat frame of the wheelchair. The Manus was connected to the wheelchair battery. In addition, a number of adjustments were made to the joystick and its attachment to

enable individuals with different needs to use it, for example to make it possible to control the manipulator with the right or the left hand, or with the chin.

Test Users

In February 1997, a solicitation of interest was sent to fifteen individuals with high-level spinal cord injuries. The group was made up of individuals living in Skåne County who had been injured after 1983 with injuries at the C5 level and who were, or had been, patients at the Department of Rehabilitation at Lund University Hospital.

Only three individuals were able to participate in the trials. During the year, two recently injured individuals and two individuals with older injuries who had come to the Department of Rehabilitation for follow-up visits joined the group of test users. In addition, one individual with a congenital disability contacted us and because she was actively searching for a robotic aid, she was given the opportunity to participate in the trials. In total, eight individuals participated in the trials, see Table 5.1.

<i>Test user</i>	<i>Gender</i>	<i>Age</i>	<i>Injury level</i>	<i>Complete/ Incomplete injury</i>	<i>Time since injury</i>	<i>Living Arrangement</i>	<i>Family</i>	<i>Assistance hours per day</i>	<i>Occupation</i>
A	M	47	C 3 - 4	C	21 years	Service apartment	Single	12	Not working
B	M	24	C 3 - 4	C	2 years	Indep.	Single	24	Student
C	M	51	C 4 - 5	C	11 years	Indep.	Single	13	Office work
D	M	33	C 4 - 5	C	11 years	Indep.	Married	10	Office/ Computer work
E	M	45	C 5	C	14 years	Indep.	Married	12	Office work
F	M	22	C 5	C	6 months	Not discharged	Single	24	Former carpenter
G	M	40	C 5 - 6	C	8 months	Indep.	Married	16	Office work
H	F	26	Congenital spinal muscular atrophy	-	-	Indep.	Lives with partner	24	Student

Table 5.1 Eight individuals participated in the Manus trials at the Department of Rehabilitation at Lund University Hospital from May 1997 to May 1998. The data was valid at the time of the trials.

To facilitate the planning of the trials, four non-disabled occupational therapists carried out two different tasks using the Manus. The tasks consisted of pouring and drinking a glass of juice, and making and eating a sandwich. Each task was performed using two different control devices: a joystick and a keypad. The time required to carry out these tasks was measured.

The occupational therapists were able to carry out the tasks without any technical problems. After practicing for 2-3 hours, they were able to pour a glass of juice and drink it in 5-10 minutes and to make a sandwich and eat in about 15-30 minutes. On the other hand, learning the many functions of the Manus while at the same time planning how to carry out the tasks required concentration and was tiring. Consequently, the trials were limited to half-days with several breaks.

Manus Trials

Between May 1997 and May 1998, eight individuals with a physical disability tested the Manus manipulator in carrying out various tasks. Each of the eight test users tried the Manus for a total of 2-13 hours over 1-3 days, see Table 5.2. The trials were carried out at the Department of Rehabilitation at Lund University Hospital, except in the case of two users who tried out the Manus at home for about 2 hours on the third day.

User	A	B	C	D	E	F	G	H
Number of Days	1	1	3	1	3	2	1	1
Number of Hours at Center	4	2	13	4	10	3	4	8
Number of Hours (Effective Time)	1.5	0.5	3.0	2.0	3.0	1.5	1.5	1.5

Table 5.2 Number of days and hours of testing the Manus arm.

In order to avoid having to modify the test users' personal wheelchairs, they used the wheelchair on which the Manus manipulator was mounted. After a 10-minute description of the operation of the Manus, the users were given the opportunity to practice with assistance for about 30 minutes. One of their first tasks was to turn over a dice in a specific way. The dice had a red dot on one side and was supposed to be turned so that the red dot faced upwards. This exercise forces the user to distinguish between controlling the position and the orientation of the end-effector, and to plan movements in advance in order to be able to complete the task.

Next, the users were asked to choose which tasks they wanted to carry out, see Table 5.3. When completing the initial tasks, the users were given plenty of instruction on controlling the Manus, but as they learned how the menus work and how the manipulator moves, the amount of help given was reduced.

The trials ended with the following compulsory activity: opening a kitchen cupboard, taking out a glass and putting it on a table, opening a refrigerator, taking out a pitcher of water from the refrigerator, pouring water into the glass, putting the pitcher back in the refrigerator and closing the door. If they wished, the test users could end the exercise by drinking the water: putting a straw into the glass if necessary, picking up the glass, drinking, and putting the glass back on the table.

Task	User A	User B	User F		
Turning a cube (practice exercise)	7 min, 3	8 min, 3			
Pitcher and glass in cupboard, pouring and drinking			37 min, 4		
Task	User C	User D	User E	User G	User H
Turning a cube (practice exercise), 1 st attempt:	10 min, 3	6 min, 3	8 min, 3	5 min, 3	7 min, 3
2 nd attempt:	2 min, 5		6 min, 5		
Pitcher and glass on table, pouring and drinking	22 min ¹ , 3		25 min ² , 3	16 min, 4	
Pitcher and glass in cupboard, pouring and drinking	18 min ³ , 2 ⁵		26 min ⁴ , 4		
Picking up objects from the floor (crutch, keys, remote control)	10 min, 3	10 min, 3	7 min, 4		6 min, 3
Picking up a newspaper			5 min, 4		
Videotape in	8 min, 2 ⁵		9 min, 4		5 min, 5
Videotape out	2 min, 2 ⁶		8 min, 4		
	7 min, 2 ⁷				
Book or binder from shelf	5 min, 4	5 min, 3	7 min, 5		
	11 min, 2 ⁵		10 min, 3		
Book or binder to shelf	9 min, 2 ⁵				
Large button (elevator button)	0,5 min, 5				
Small button (TV, washing machine)				5 min, 3	4 min, 3
					7 min, 3
Knob (burner, washing machine)				4 min, 4	5 min, 3
Getting remote control			7 min, 4		3 min, 5
Getting bottle opener		2 min, 5			
Opening bottle		15 min, 1			
Filling pot with water					8 min, 5
Opening a door	2 min, 3				
Opening a book	6 min, 0				

¹Including 8 min using a straw.

²Including 5 min using a straw.

³Not including drinking and putting the pitcher back.

⁴Not including drinking.

⁵Dropped the object.

⁶Could not hit the eject button.

⁷The tape was stuck.

Table 5.3 Time spent on various tasks. Some tasks were carried out several times. The difficulty of the task was assessed on a scale of **0-5** (marked with bold):

0: Unable to complete any part of the task. **1**: Able to carry out one or a few steps.

2: Able to carry out some steps, but not all. **3**: Able to carry out all the steps, but with great difficulty.

4: Able to carry out all the steps, but with some difficulty. **5**: Able to carry out all the steps without difficulty.

The test users' levels of activity limitation were assessed by having them all carry out the compulsory activity both with and without the aid of the Manus.

During the trials, the users were interviewed and asked to comment on the robot. The trials were videotaped.

In June 1998, a questionnaire was sent to the eight test users, see Appendix C. The questionnaire contained questions concerning how the users felt about the trials before and after they were carried out, including questions about how soon after their injury they would like to receive information about and test robotic aids. It included a list of spontaneous comments by the users, and they were asked if these comments matched their own impressions. Finally, it included questions about the robotic aid itself.

Additional Practice with a Manus User

After the trials, one of the users bought her own Manus manipulator. Personal information about the tester: Woman, born in 1971, congenital spinal muscular atrophy, has only limited mobility in right arm and hand. Controls an electric wheelchair by means of a joystick, needs assistance with all personal care, has a personal assistant 24 hours a day. Needs help to dial and to hold the receiver when talking on the phone. Unable to carry out any IADLs. Works at Independent Living in Göteborg. Lives with partner.

Since becoming an adult, she has not wished to receive any assistance from the medical services. She feels she had enough of the medical services when she was a child. She has 24-hour personal assistance. She has begun to look for ways to avoid having assistance around the clock. This became even more important to her when she began living with her partner. She began to wonder if she might be helped by robot technology. She contacted Certec and was subsequently introduced to the Manus manipulator and to an occupational therapist at the Department of Rehabilitation at Lund University Hospital. It was clear that the Manus could be a useful tool for her.

In November 1998 she bought her own Manus and it was agreed that she would practice for 10 days in December 1998 at the Department of Rehabilitation at Lund University Hospital using her own Manus. A Canadian assessment tool called COPM, Canadian Occupational Performance Measure (12), was used to assess various tasks with respect to how important they were, how they were carried out at present, and how satisfied she was with the way they were carried out.

We held continual discussions during the first three months after she started using the Manus. The discussions covered a

number of points, for example what the Manus has meant to her, what she has used it for and to what extent, whether it has made her more self-reliant and independent in various situations, as well as the types of modifications she would like to see to enable her to use the Manus more and to make her want to use it more.

5.1.4 Results

Trial results

Table 5.3 shows the tasks the testers chose to carry out using the Manus, how long it took to complete each task, and an assessment of how well they were able to carry out the tasks on a scale from 0-5 (0-2: with assistance 3-5: without assistance).

Seven of the eight users managed to carry out the final compulsory task without assistance when they were allowed to use the Manus, see Table 5.4. Without it, they were unable to complete the task.

	User A	User B	User C	User D	User E	User F	User G	User H
Without the Manus	0	0	0	1	1	1	1	0
With the Manus	63 min, 2 dropped the glass	14 min, 4 got out pitcher and glass	28 min, 4 not drinking	43 min, 3	24 min, 4 not drinking	24 min, 4	21 min, 4 not getting glass or drinking	17 min, 4 not pouring or drinking

Table 5.4 Time spent on and assessment of final compulsory task of pouring a glass of water and drinking it. The degree of difficulty was assessed on a scale of 0-5 (marked with bold), both with and without the aid of the Manus manipulator:

- 0:** Unable to complete any part of the task. **1:** Able to carry out one or a few steps.
- 2:** Able to carry out some steps, but not all. **3:** Able to carry out all the steps, but with great difficulty.
- 4:** Able to carry out all the steps, but with some difficulty. **5:** Able to carry out all the steps without difficulty.

The technology was reliable throughout the trials, but almost all of the users found it difficult to control the wheelchair they were using for the trials. A common observation from the users was that the Manus was in the way when they wanted to bring the wheelchair close to a table. They commented that they wanted to be able to place the manipulator at an angle when sitting at a table or attach it behind the seat back rather than at the side of the wheelchair. The technical results of the trials are described separately (6).

Two test users immediately commented that it felt strange that the Manus was attached to the left side of the wheelchair when they themselves were right-handed. One of them made this comment despite the fact that it had been eleven years since she

had used her right hand. When adapting the Manus to individual needs it is possible to choose which side of the wheelchair it should be mounted on. The movement pattern of a robot can influence to what extent users accept it (1).

In connection with the trials, the test users made the following comments: “With the Manus, I would be able to handle private documents and letters”, “I could turn on all the lamps in my home”, “I don’t ask for more than I need” (not wanting to be a burden to society by asking for life-enhancing assistive technology), “I could open doors and use the phone when there is a power failure”, “I could get a binder without asking for help”, “I feel more independent”, “I would be able to pick up the environmental control unit”, “I could do a lot of little things”, “I wouldn’t need to wait for assistance”, “The Manus would enable me to be by myself without having to ask anyone to help me so that I can be on my own”.

Questionnaire Responses

Seven of the eight test users answered the questionnaire. Figures 5.1a, b, c, and d show to what extent the test users agreed with four statements about why they wanted to try the Manus. All of them wanted to find out whether a robot would suit them. Six of the users thought it was interesting to try new assistive devices and the same number are looking for tools that can increase their independence.

Figure 5.1a, b, c and d
Questionnaire responses on the question *Why did you want to try the Manus?*

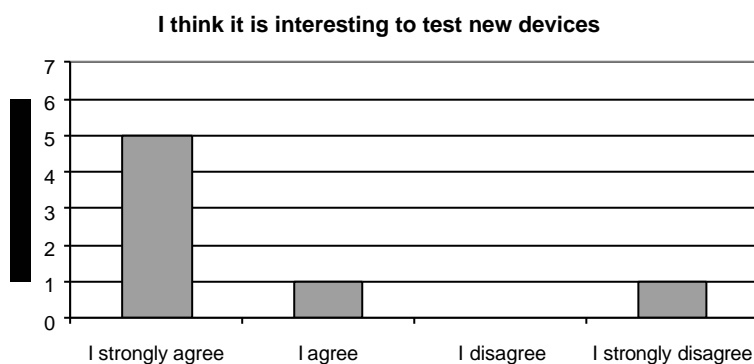

Figure 5.1a
I think it is interesting to test new devices.

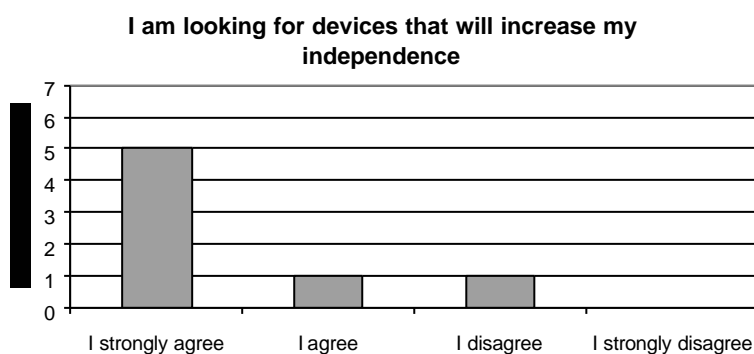

Figure 5.1b
I am looking for devices that will increase my independence.

Figure 5.1c
I wanted to find out if a robot would suit me.

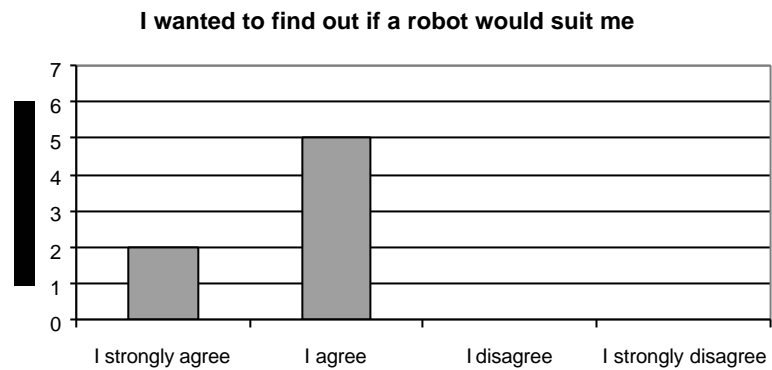
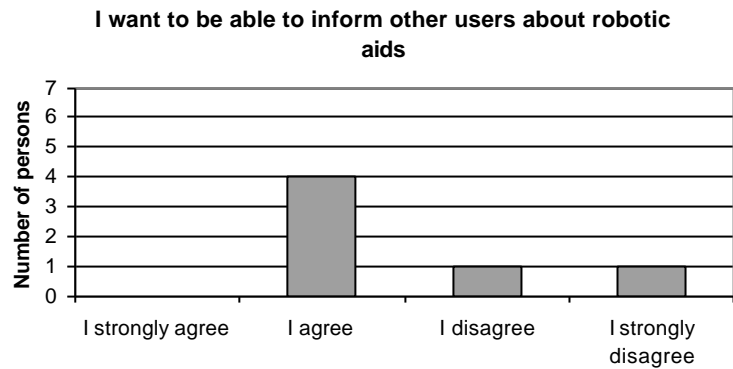
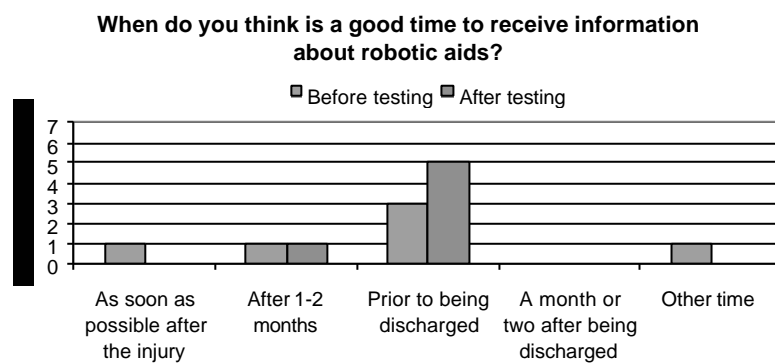

Figure 5.1d
I want to be able to inform other users about robotic aids.



The users stated that they probably would not have liked to test the Manus too soon after their injury. Five test users answered that it is good to have the opportunity to try out robotic aids before being discharged, see Figure 5.2. All the test users believed that it is important to receive information about the availability of robotic aids. One user stated that seeing others carry out tasks using the Manus would have motivated him.

Figure 5.2 Questionnaire responses on the question *When do you think is a good time to receive information about robotic aids?*



After the trials, five test users have been in a situation where they thought: “The Manus could help me with this.” Those who answered yes to this question provided the following examples: “It would be nice to be able to drink something when I am by myself.”, “Getting things that are high up or on the floor.”, “When I want to get a binder or a book from a bookshelf”, and “When I am eating or having coffee”. “Being able to be alone without being stranded.”, “Being able to reach things, a book for example.”.

Five users answered that they would like to carry out tasks using the Manus instead of having their personal assistants/relatives/friends do it for them. They provided the following examples and reasons: “Changing videotapes”, “I would be more independent.”, “Because it makes me more independent.”, “Each thing you can do on your own is invaluable when you need assistance around the clock.”.

Only one of the users would like to have a Manus manipulator that looks and works like the present version. The rest thought it was too big, too heavy, and too difficult to use. On the other hand, four of the users would like to have a Manus manipulator if it was improved in some way. They suggested the following improvements: “Make it easier to handle”, “Make it more flexible and integrate the joystick into the wheelchair”, “It should be easier to use”, “Smaller, more flexible, easier to maneuver”, “It should not be located in front of the wheelchair.”, “It should be possible to control it with the wheelchair joystick.”, “It should be more flexible, easier to control, lighter”, and “It should be stronger” (capable of lifting heavier objects). “Smaller motor, longer arm, attached to the back of the wheelchair, two arms to substitute for my own.”.

Figures 5.3a, b, c, and d show to what extent the test users thought that the comments made by the other users accorded with their own experience.

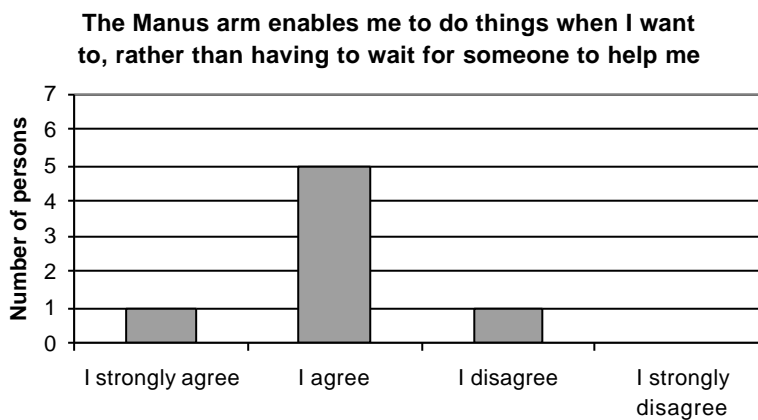

Figure 5.3a, b, c and d
To what extent comments made by other users accord with test users' own experience.

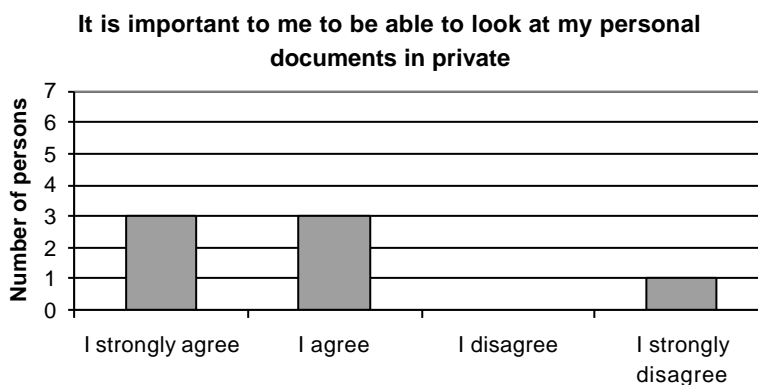

Figure 5.3a
The Manus arm enables me to do things when I want to, rather than having to wait for someone to help me.

Figure 5.3b
It is important to me to be able to look at my personal documents in private.

Figure 5.3c
I have adapted my day so that I get help when it is available, so I can't think of very many situations where the Manus would be useful to me.

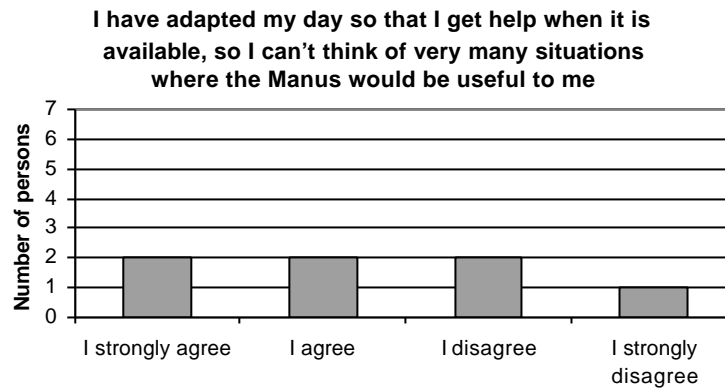
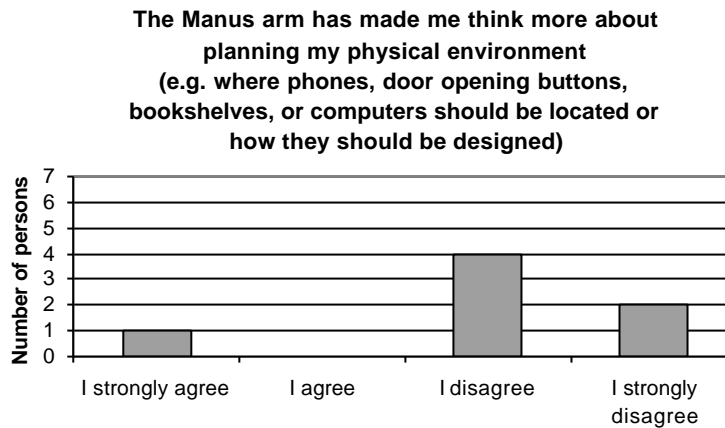

Figure 5.3d
The Manus arm has made me think more about planning my physical environment (e.g. where phones, door opening buttons, bookshelves, or computers should be located or how they should be designed).



Six users emphasized how important it is to be able to look at personal papers in private. One individual provided the following comment to the statement in Figure 3c about organizing your day so that you get help when it is available: “That statement was made by an individual who has turned off certain feelings since it is impossible to live only when others are available to help you.”

Answers to questions about independence and quality of life are shown in Figures 5.4a and 5.4b. Six users answered that the Manus manipulator would increase their independence and improve their quality of life.

Figure 5.4a
Questionnaire responses on the question **Would a Manus make you more independent in some way?**

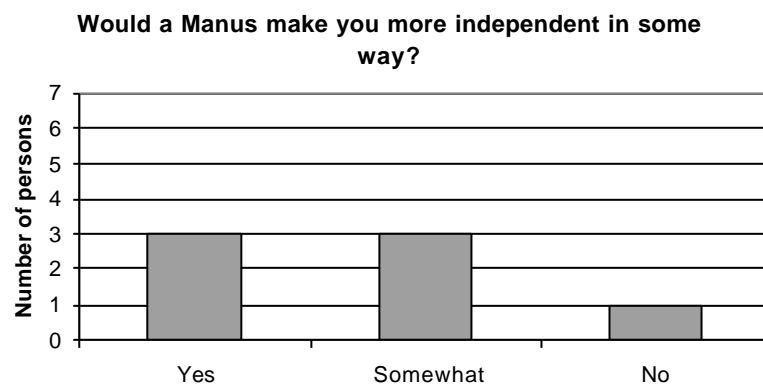

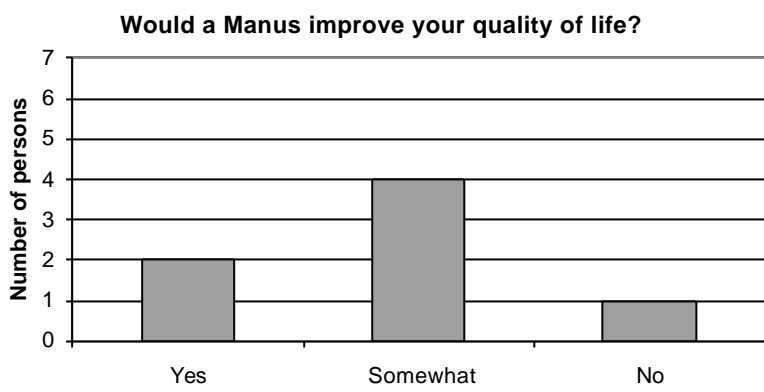

Figure 5.4b
Questionnaire Responses on
the question
***Would a Manus improve
your quality of life?***

Results from Practice Sessions with a Manus User

The new Manus owner selected the following tasks for a 10-day practice period at the Department of Rehabilitation at Lund University Hospital: drinking, making coffee, cooking an easy meal, phoning, and getting through a door. A new assessment was made after the practice period. The tasks she was most satisfied with were drinking and making coffee. She was also more satisfied with how she accomplished the tasks of opening and closing a door and making a telephone call. On the other hand, there was no change when it came to cooking an easy meal. The assessment accurately reflected the clinical observations of the test user's ability to use the Manus.

She was able to make coffee on her own, get a cup, pour the coffee, and drink it. She was able to pick up a telephone receiver, hold it in the correct position, and put it back again. She was able to open and close unlocked doors but unable to turn a key to lock a door. Using a frying pan and a spatula proved too difficult to be practical and not satisfactory in terms of safety. She successfully completed the task of lighting a candle using a lighter, but this task should not be attempted if the person is alone because of the fire hazard. During the practice period, she also completed the tasks of mixing a cake and putting the baking tin in the oven fairly successfully, but with some assistance.

5.1.5 Discussion

Not all the tasks listed in the preliminary discussions with the three individuals with high-level spinal cord injuries were carried out during the trials. The reason for this was that only one of them participated in the trials.

The amount of time it took each person to complete a task should not be compared to how long it took the others because the users did not spend the same amount of time practicing before carrying out the tasks. The users practiced by carrying out the various tasks, but the tasks were not carried out in the same order. Before the first practice task, some of the users carried out

movements with the Manus to find out how it worked and, consequently, they were somewhat more prepared for the task than the other test users. The purpose of the trials was not to compare the times of different users but to gather experience in order to make the best possible use of robots in rehabilitation.

On the other hand, it is possible to compare the times for a single user who carried out a task several times, e.g. C, who reduced the time required to complete the practice task from 10 to 3 minutes. This means that the test users' proficiency increased quickly, particularly if they had carried out that particular task before.

At first, the users had difficulty understanding which menu they should use to make the robot move the way they wanted. They found it especially difficult to turn the end-effector so that it would be oriented correctly. They also had difficulty planning a movement in advance so that it would be easier to carry out. This involves grasping the object in the right place and carrying out the tasks in the right order, i.e. planning the tasks in the way a one-armed person would have done. For example, in the case of the final task, where the user is asked to get a pitcher and a glass and then pour water into the glass, the task can be completed much faster by first getting the glass and then the pitcher, making it possible to pour the water into the glass directly, without having to put the pitcher down in order to get the glass. Carefully putting the pitcher down and then grasping it again is more time-consuming.

The most common reason why the assessment 2 was given for some of the tasks, i.e. not completed independently even though the user was able to carry out some or almost all of the steps, was that the user dropped the object. Only A and C, i.e. the only users who used chin control, dropped objects, because it was impossible to place both joysticks (for the wheelchair and the Manus) directly in front of the chin and the menu alternatives for up/down and grasp/release were on the same menu. If, for example, they lifted a glass by moving the joystick almost straight forward but slightly to the side, the end-effector would open. This problem can be solved by adapting the menu structure to the individual user, which is possible with the present technology. Several test users wanted to be able to use the wheelchair joystick to control the Manus. Even using the present Manus, an experienced user can avoid dropping objects by stopping at regular intervals and grasping the object more firmly.

Assessment 3, i.e. independently but with great difficulty, does not necessarily mean that it took a long time to complete the task, although it usually did. It refers to problems such as dropping an object but being able to pick it up again and continue without

assistance, difficulty understanding how to orient the end-effector, or spilling when pouring water.

Although half a day is sufficient for someone to learn how to use the Manus, one or two additional half-days are required to become familiar enough with the robot to avoid most beginner's mistakes. In three half-days, the user has sufficient time to carry out a large number of tasks and familiarize himself with the robot. Part of the first half-day is spent adapting the control device to the user.

Despite the fact that six users think the Manus manipulator would make them more independent and improve their quality of life, only one of them would like to have a Manus that looks and works like the present version. The users probably believed that the question regarding increased independence and higher quality of life referred to an improved Manus manipulator, since it is difficult to imagine that someone would not want something that would improve their quality of life.

People with injury level C5 are often able to turn the pages of a book, but have difficulty getting a book or a binder from a shelf. The Manus can help them with that.

5.1.6 Conclusions

The technical reliability of the Manus manipulator was high during the trials. The test users were able to carry out almost all of the tasks independently.

Half a day is sufficient for someone to learn how to use the Manus, but one or two additional half-days are required to become familiar enough with the robot to avoid most beginner's mistakes. In three half-days, the user has sufficient time to carry out a large number of tasks and familiarize himself with the robot. However, it takes two to three weeks to become a skilled user and to make the adjustments necessary for practice sessions in more realistic conditions.

5.1.7 References

1. Apostolos, M.K.: Exploring user acceptance of a robotic arm: an aesthetic orientation. *J Am Paraplegia Soc* 8:51-54, 1985.
2. Bolmsjö, G., Neveryd, H. & Efring, H.: Robotics in rehabilitation. *IEEE Transactions on Rehabilitation Engineering* 3:77-83, 1995.
3. Dallaway, J.L., Jackson, R.D. & Timmers, P.H.A.: Rehabilitation robotics in Europe. *IEEE Transactions on Rehabilitation Engineering* 3:35-45, 1995.
4. Danielsson, C. & Holmberg, L.: Evaluation of the RAID workstation. *Proc RESNA'94Annu Conf*, Nashville, TN, pp 451 - 453, June 17 - 22, 1994.

5. Dijkers, M.P., DeBear, P.C., Erlandson, R.F., Kristy, K., Geer, D.M. & Nichols, A.: Patient and staff acceptance of robotic technology in occupational therapy: a pilot study. *J Rehabil Res Dev* 28(2):33-44, 1991.
6. Efrting, H. & Boschian, K.: Technical Results from Manus User Trials. ICORR'99 (International Conference on Rehabilitation Robotics), Stanford University, 136-141, 1999.
7. Efrting, H.: Robot control methods and results from user trials on the RAID workstation. Proceedings of the Fourth International Conference on Rehabilitation Robotics (ICORR), pp 97-101, Wilmington, Delaware, USA, June 1994.
8. Glass, K. & Hall, K.: Occupational therapists' views about the use of robotic aids for people with disabilities. *Am J Occup Ther* 41:745-747, 1987.
9. Harwin, W.S., Rahman, T. & Foulds, R.A.: A review of design issues in rehabilitation robotics with reference to North American research. *IEEE Transactions on Rehabilitation Engineering* 3:3-13, 1995.
10. Kerrigan, A.J.: The psychosocial impact of rehabilitation technology. *Phys Med Rehabil: State of the Art Reviews* 11:239-252, 1997.
11. Kwee, H.H.: Rehabilitation robotics - softening the hardware. *IEEE Engineering in Medicine and Biology Magazine* 14:330-335, 1995.
12. Law, M., Baptiste S., Carswell A., McColl M.A., Polatajko H. & Pollock N.: Canadian Occupational Performance Measure (COPM), second edition. Published by the Canadian Association of Occupational Therapists, Toronto, 1994. ISBN 1-895437-10-5.
13. McLean, V.P.: Using robots in a group with the neuropsychologically impaired: achieving a sense of control over the environment. *Occup Ther Ment Health* 8:155-164, 1988.
14. Peters, G. & deMoel, F.: Evaluation of Manus Robot Arm users in the context of the General Invalidity Act. GMD Evaluation Report, Amsterdam, Sept 1996.
15. Platts, R.G. & Fraser, M.H.: Assistive technology in the rehabilitation of patients with high spinal cord lesions. *Paraplegia* 31:280-287, 1993.
16. Prior, S.D.: An electric wheelchair mounted robotic arm - a survey of potential users. *J Med Eng Technol* 14:143-154, 1990.
17. Rahman, T., Stroud, S., Ramanathan, R., Alexander, M., Seliktar, R. & Harwin, W.: Task priorities and design for an arm orthosis. *Technology and Disability* 5:197-203, 1996.

18. Stanger, C.A. & Cawley, M.F.: Demographics of rehabilitation robotics users. *Technology and Disability* 5:125-137, 1996.
19. Stanger, C.A., Anglin, C., Harwin, W.S. & Romilly, D.P.: Devices for assisting manipulation: a summary of user task priorities. *IEEE Transactions on Rehabilitation Engineering* 2:256-265, 1994.
20. Verburg, G., Kwee, H., Wisaksana, A., Cheetham, A. & van Woerden, J.: Manus: The evolution of an assistive technology. *Technology and Disability* 5:217-228, 1996.
21. Øderud, T., Bastiansen, J.E. & Tyvand, S.: Experiences with the MANUS wheelchair mounted manipulator. *Proc ECART 2*, Stockholm, p. 29.1, May 26 - 28, 1993.

5.2 Technical Results from Manus User Trials

Håkan Efring¹, MSc; Kerstin Boschian², OT

¹ Certec (Center for Rehabilitation Engineering Research), Lund University, Sweden

² Department of Rehabilitation, Lund University Hospital, Sweden

5.2.1 Abstract

Eight users have tried the Manus arm at the Department of Rehabilitation at Lund University Hospital. The user trials were carried out in close co-operation with Certec at Lund University.

After the trials one of the users, Ms Eva Gerdén, decided to buy a Manus arm, and she received her Manus arm in November 1998.

The main objective of the user trials was to find out how robot technology could support the early rehabilitation of people with spinal cord injuries. Another objective was to increase the knowledge of user needs and what make robots worth using.

This paper presents technical comments received during the user trials and from Ms Eva Gerdén. The results could be used for improvements to the Manus arm, to other wheelchair-mounted manipulators and to robots in general.

One of the most commented issues is the physical size of the Manus arm, preventing the user from driving the wheelchair close to a table or maneuvering the wheelchair through narrow passages.

Two of the users immediately stated that it was awkward to have the Manus arm mounted on the left side of the wheelchair, since they are right-handed.

Section 5.2 has been published in Proceedings of the sixth International Conference on Rehabilitation Robotics (ICORR), pp. 136-141, Stanford, California, USA, July 1999.

5.2.2 Background

Certec at Lund University and the Department of Rehabilitation at Lund University Hospital have been co-operating within the field of rehabilitation robotics since 1993 when a RAID workstation was installed and evaluated.

In 1996 we received funding for creating a National Rehabilitation Robotic Center at the Department of Rehabilitation. A Manus arm [1, 2] (the first in Sweden) was purchased and user trials were carried out from May 1997 to May 1998. The main objective of the user trials was to find out how robot technology could support the early rehabilitation of people with spinal cord injuries.

After the trials, one of the users, Ms Eva Gerdén, decided to buy a Manus arm, and she received her Manus arm in November 1998. She is so far the only Manus end user in Sweden.

Another objective of the user trials was to increase the knowledge of user needs and what make robots worth using.

Certec's interest in theory and method is documented in "Certec's Core" [3].

5.2.3 Methods

Eight users have tried the Manus arm at the Department of Rehabilitation at Lund University Hospital. The user trials were carried out in close co-operation with Certec at Lund University.

Seven of the eight users have spinal cord injuries (C3-C6) and they had been injured 0.5-21 years at the time for the trials. One user has a spinal muscular atrophy since birth. The ages of the users were 22-51 years.

Approx. 15 patients and earlier patients at the Department of Rehabilitation were invited to the trials. Seven of them wanted to be part of the trials. The eighth user in the trials, Ms Eva Gerdén, was actively looking for robotic aids and was therefore invited to the trials.

The Manus arm was mounted on a Permobil Max90 wheelchair, see Figure 5.5, and the users had to move from their own wheelchairs to the Permobil wheelchair during the trials. Two joysticks were used for controlling the Manus arm and the wheelchair. Some users could use their hands to control the joysticks and some users used chin control.

Each user tried the Manus arm 3-4 hours per day for 1-2 days at the Department of Rehabilitation. Two of the users asked to try the Manus arm at home for 2 hours, and so they did.



Figure 5.5 The Manus arm mounted on a Permobil Max90 wheelchair.

The users could choose which tasks to carry out, and at the end all users carried out the following drinking task:

Open a kitchen cupboard,
bring a glass to the table,
close the cupboard,
open a refrigerator,
grasp a jug of water,
pour water into the glass,
return the jug to the refrigerator,
close the door,
insert a straw if necessary,
drink the glass of water and
return the glass to the table.

Other tasks carried out by the users:

- Take a book or a binder from a shelf and put it on a table or on their knees.
- Insert a video tape into a video cassette recorder and return the video tape to a table.
- Reach the environmental control unit from a shelf.
- Pick up things (e.g. a hand stick or a remote control) from the floor.
- Pick up a dropped magazine from a user's feet and put it back on his knees.
- Press door opening buttons and elevator buttons.
- Open the front door of a user's house.

During the trials, comments and suggestions from the users were written down and followed by a discussion. After the trials, a questionnaire was sent to the eight users.

More thorough discussions have been held with Ms Eva Gerdén after she decided to order a Manus arm. There has been a continuous dialogue with her about adaptations, modifications and suggestions for improvements as well as about the importance of independent living.

This paper presents technical comments received during the user trials and from Ms Eva Gerdén. The results could be used for improvements to the Manus arm, to other wheelchair-mounted manipulators and to robots in general.

5.2.4 Results of the Questionnaire

Seven of eight users answered a questionnaire. Only one user wanted to have a Manus arm as it looks and works today. The other users thought it was too large, too heavy and too difficult to control.

However, four users would like a Manus arm if it was improved. The following improvements were mentioned: It should be mounted on the back of the wheelchair. It should be possible to use the wheelchair joystick to control the Manus arm. It should be smaller, lighter, easier to use and have more reach. It should be possible to lift heavier things.

Five users would like to try the Manus arm again, if it was improved.

Speed: Three users think it is too slow.
Three users think it is OK.

Strength: Four users think it is too weak.
Three users think it is OK.

The most difficult thing when using the Manus arm: Too many “commands” for a small adjustment. Too many functions to keep in mind in the beginning. Using the joystick.

Comments and Suggestions Received from the Users

One of the most commented issues is the physical size and position of the Manus arm, preventing the user from driving the wheelchair close to a table or maneuvering the wheelchair through narrow passages.

Furthermore, the view from the wheelchair is limited when the Manus arm is mounted, and even more limited when folded out.

Two of the users immediately stated that it was awkward to have the Manus arm mounted on the left side of the wheelchair, since they are right-handed (even if they have not used their right hands for many years).

Modify the fold out and fold in procedures, so they don't require so much space. Turn the base all the way to the user's legs before folding out the upper and lower arms just in front of the user.

The Manus arm is mounted above one of the front wheels, which makes wheelchairs with small front steering wheels difficult to steer. It is also harder to drive the wheelchair up a sidewalk curb.

More reach to the floor. In general, the reach is too short. The maximum payload is too low to manipulate a 1 kg pot without problems. The position of the gripper relative the center of gravity of the object to be grasped causes high torque. It should be possible to see how hard the gripper is holding an object.

Detect the weight of a grasped object (e.g. a milk package) to be able to know how much I can tilt it before the milk is at the edge of the package. It is frustrating to find out that the package is almost empty, when you have been very, very careful during the pouring movements.

A gripper with three fingers might be more useful and might be more rigid than the two-finger gripper. The fingers of the gripper should be a little thinner, narrower and rounded to be able to grasp small things 45 degrees from vertical.

It is very difficult for the user to use two joysticks (one for the wheelchair and one for the Manus arm). A joystick switch box for the Permobil wheelchair is not yet available. The Manus display should be integrated with the wheelchair display.

The Manus joystick can rotate around itself. This is a problem when you need to have a Y-shaped adaptation on the joystick on which you can put your hand. If you lift the hand from this Y-shaped adaptation, it is difficult to put the hand back.

Sometimes it is not good to have the movement of the Z-axis and the open/close movement in the same joystick menu. When you control the joystick with your chin and move the arm in the Z direction, it is hard to prevent the gripper from opening by mistake (and dropping an object). However, when you can control the joystick without problems, it is very good to have these movements in the same menu.

The two menu alternatives “Away” and “Closer” should be added to the keypad drink menu. This is good if you have to grasp a glass close to the table, to prevent the fingers of the gripper from pushing against your lips. The speed of the “Stop drinking” movement should be faster than the “start drinking” movement.

Small and large circular movements should be introduced, to be able to stir sugar in a cup of coffee or to stir food on the stove.

Short movements with high acceleration would make it possible to push food (e.g. meat balls) around in the fry-pan.

5.2.5 Discussion & Conclusion

The mounting position of the Manus arm unnecessarily limits the number of potential users. People with spinal cord injuries at the levels C5-C6 will hardly accept a Manus arm, which stops them from driving very close to a table. This is necessary to be able to use their limited arm/hand functions.

A solution where the Manus arm temporarily could be moved back along the side of the wheelchair is desirable. It should still be possible to use the Manus arm from this position. An arm mounted on the back of the wheelchair would be a better solution in this perspective, since the wheelchair would be narrower without the arm on the side.

The results of the user trials indicate that integration of the wheelchair and the robot arm is the key to success for wheelchair mounted manipulators. If wheelchair manufacturers could have their wheelchairs prepared and approved for mounting robot arms, the enormous amount of work for each adaptation could be

reduced and the user would have an optimum solution. The robot might then be worth using.

5.2.6 Acknowledgements

Funding for carrying out the user trials and creating a National Rehabilitation Robotic Center was provided by The National Board of Health and Welfare in Sweden.

Research activities in this field was funded by Stiftelsen för bistånd åt rörelsehindrade i Skåne, a Swedish foundation.

5.2.7 References

- [1] G Peters; F de Moel, *Evaluation of Manus Robot Arm users in the context of the General Invalidity Act*
GMD Evaluation report, 1996
- [2] H H Kwee, *Integrated control of MANUS manipulator and wheelchair enhanced by environmental docking*
Robotica, vol 16, pp 491-498, 1998
- [3] B Jönsson, *Certec's core*, 1997
<http://www.certec.lth.se/doc/certecscore/>

6 In-depth Interview with a Manus User

This is an excerpt from a two-hour in-depth interview with Eva Gerdén on April 23, 1999. Before she bought her Manus manipulator in November 1998 we had many discussions about the technical requirements a robotic arm should meet to suit her needs. I installed the Manus on her wheelchair and I have communicated her comments and suggestions for improvements to the manufacturer.

The interview was taped and subsequently typed out in full. The following is an edited version in which the order of the questions has been changed and some answers have been combined to make the text more cohesive. Eva Gerdén has read the present version and approved it.



Figure 6.1 Eva Gerdén.

6.1 Why Is “Useworthy” a Good Concept?

What were your thoughts the first time you heard of the term “useworthy”?

Cool. I’ve always liked that concept.

What do you think of “useworthy” compared with “usable”?

To me, useworthy is about how I value something. I mean, something is not useworthy to me just because you think it’s useful. I must be the one making that decision.

So I can’t say that because it is useworthy to me it must be useworthy to you?

Exactly. That’s what’s so exciting, because it’s so unique in the world of assistive technology. I hate everything to do with technical aid centers and assistive devices and all that stuff. Because it has been like this: “Look at this. This is good. Take this one! You need it! It’s good,” but perhaps I’m thinking: “This is garbage. What do I need it for?” This is the first time, as far as I know, that a concept is used which is based on whether I think a device is good or not. It doesn’t matter if thirty people say it’s good. If I don’t think so, then it isn’t. Then it’s not useworthy to me. There are many instances where the concept of useworthiness should be used instead, because then maybe the views of the person involved would become the starting point. Right now, what I get depends on someone else’s opinion which I’m supposed to accept. That’s unreasonable.

What makes the Manus manipulator worth using in your opinion? Because you can do things that are important to you?



Figure 6.2 Håkan Efrting.

Håkan’s questions are marked in normal style and Eva’s answers are marked in italic style.

Yes. It is very important to me to be able to do something without having to tell someone what it is I want to do. Being able to think, without having to talk about it. I can do that with the Manus manipulator. Even if it takes me three hours at least I can do it. That means I don't have to talk to someone for three hours, if I don't want to. It might have taken me ten minutes to do it with the help of my assistant, but it doesn't matter, because then I would have had to give instructions, and that might be just as tiring as spending those three hours. My goal is to find more things that I can do independently in combination with the robot, at least for a couple of hours and preferably all day. My goal is to become completely independent with the aid of assistive devices, even if at first it may only be half an hour or an hour, the objective is complete independence. And I will have that some day. I'll have a lift that I can use on my own, so that I can get up on my own and do everything myself.

Do you have a list of tasks that you would like to be able to do, making coffee or opening the mail, for example?

Where do you want me to start?! But, I see it like this: If I could manage that, I would automatically be able to do it. Because I feel that some things are so interconnected. If I can make the coffee, I'll be able to drink it, too. I don't worry about the little things. I look more at the big picture. I rarely think about being able to open the mail, but that's probably because I need so much assistance, so I think "opening the mail can't be that hard." That's not a problem. The real problem is: How do I get in and out of bed? And how do I change my clothes by myself? And how do I use the bathroom on my own? And how do I eat independently? And how do I do things around the house, and I mean everything and on my own.

6.2 Assistive Devices

Have you always been searching for assistive devices that will make you more independent?

I've shied away from assistive devices. I've never searched for them.

You were only looking for a robot?

A robotic arm.

Was that the only thing you were looking for?

Yes.

At exhibitions and things like that?

No, I was looking for Certec. Because I'd heard that you were doing research on technology for people with disabilities. I'd never heard of it anywhere, so I thought that maybe it doesn't exist. I thought: Why doesn't it exist? It would be really ingenious. So I thought: But I could tell them about it, and they would be able to make one. But you already had one.

And we were looking for someone who would want to test it.

It was really strange. A girl who wanted to try it.

So you haven't been looking for other assistive devices that would make you independent?

No, the only thing I've considered is Smartbo, but at the same time I felt like this: What's the point of me switching lights on and off when I have to have someone with me all the time anyway? I'm not looking for... Well, now I feel that it might be a good complement, but that's only because I have the Manus. I wasn't looking for things like this: "Well done, you can slice bread all by yourself." But then I can't butter it or eat it or anything. I've never been interested in those kinds of solutions and that is the only thing occupational therapists and technical aid centers do, because they think it's so important, but it's totally unimportant, it's unbelievably stupid. Because you have to look at the big picture. It's about doing the whole sequence. They don't look at the whole sequence of what you do and don't do.

And with the robot you are so close that with a few additional tools you would be able to have some time periods where you could do things all by yourself?

Yes, I think so, because I'm really convinced that with the use of technology I could be almost completely independent. I am totally convinced that one day I would be able to get up and get dressed ... that is, use the lift and everything. I'm totally convinced I would be able to do it.

What were your expectations before you bought the Manus? What did you think it would be capable of doing?

I had enormous expectations. I thought I would be able to get something to drink from the fridge and drink it, make tea, cook simple meals, make a sandwich, go in and out of my apartment, shut the door if I wanted to be left in peace and get out when I felt like it, sort the laundry and start the washing machine, tidy up, get a book and read it, put on a record, put on a movie, have coffee at a café, feed my cats, do practical things for my family and go shopping. I really couldn't see any limit to the things I'd be able to do. I thought the main limitation at first would be my own fear of trying new things. I thought I'd be able to do anything a person in wheelchair using one arm is capable of doing.

And how did it turn out?

When I thought about having a robotic arm I imagined it would bring a great deal of independence. I thought I would be able to manage on my own to a much greater extent than I am. My minor needs have become more obvious and more annoying. By minor needs I mean things like moving my arm backwards/forwards or to the side, leaning to one side, moving things so that I can get trough and reach something with the Manus, etc. On the other hand, I wouldn't want to be without the Manus, since it has given me a certain amount of

independence that I didn't have before. One thing I didn't think I would use it for is for drinking coffee even though my assistant is sitting next to me. I can spend more time on my own with the aid of the Manus, but not as spontaneously or as long as I thought I would. One thing the Manus has done for me is to inspire me to look for new technology that would make me more physically independent of other people.

Do you feel that with the aid of the Manus you would be able to do all those little things yourself and not have to talk and explain how you want it done, but you don't use it in that way very much?

No, because I would probably need more assistive devices in addition to the Manus. I would need a new kitchen. Our kitchen is hopeless for me to work in. And I would need some of those automatic devices that I don't want. I would need them as a complement to the Manus. I would need to be able to control it without my arm getting tired, because otherwise I would hesitate to use it since I wouldn't have the strength to do anything else, but that definitely doesn't reduce its value. It just means that everything else has to be modified, because the Manus is definitely good. I don't have any complaints about the Manus.

Would you say that it would be worth using even if you weren't able to do anything in practice because the surroundings hadn't been adapted to it? That it's enough to know that if you had a dishwasher, for example, you would be able to put the dishes into it and run it by yourself?

Yes, that's it, because I can do something about that.

Even if you don't do it now, you know that you can do something about it if you've made up your mind to do it.

Yes, exactly.

And that doesn't have an impact on how useworthy it is?

No. Because I know what the Manus is capable of. I know what I want and I know that it meets at least some of my requirements.

6.3 Having the Initiative

You know that it depends on you ... on your determination or your initiative?

Yes, exactly. Absolutely. That's why we're moving, if we can get the house I want. I've found the house I want. It's built into a hillside so you can go around the back and get to the top floor. Upstairs, there's a kitchen with a nook, and a small room that could be my assistant's room. That means that the assistant wouldn't have to come down to the ground floor. Otherwise, it's very similar to our apartment: there's a living room and a bedroom and the television on the ground floor. I want that house. I'm already imagining how great

it would be. I would have a door opener and I would have that, and that, and that...

Then you would have all the assistive devices you wouldn't have otherwise?

Yep.

Would you consider having an occupational therapist, or someone else, come and carry out modifications or give you ideas or suggestions for the kinds of modifications that are possible?

No. Yes, it depends on who it would be. Not an occupational therapist. I would never invite an occupational therapist.

But occupational therapists are the ones who carry out modifications, aren't they?

Yes, so I'll have to do it myself, because I don't want to have anything to do with them.

But what about technicians?

Yes, I might not mind that. I don't want them to tell me what's good, I want to tell them what I would like and then they can tell me if it's possible or not, and what could be done, and perhaps make suggestions like: "That's not possible, but maybe we can do this instead." That would be OK. The starting point must be what I want and not an occupational therapist saying: "We could put this here." I'm speaking in very general terms. There must be some who can do it, of course, but most of the ones I've met are incapable of letting the initiative and the feeling come from me, from what I want. That's what's so unique about useworthy, because nobody can tell me whether something is worth using or not. Only I can do that. It's up to me whether I think it is worth using or not, nobody else can decide that. I must do that myself.

Is it ok to explain the advantages of a new assistive device or to show it to someone to make them want it? Even to someone who hasn't been thinking: "A robotic arm would be great for me."

Yes, I think so.

Is that because you've been able to fantasize about the fact that a robotic arm might exist?

But people aren't the same. Some people think it's great to get tips and advice, while others don't. Just like some people like to haggle at the market and others don't. It depends on your personality, and, in my case, I need to be the one who takes the initiative. It's probably because I haven't been allowed to. When you're born with a disability, you're not used to having the initiative. I'm so used to people telling me what I need and don't need that I've grown allergic to it. I just go- no! Almost like a rebellious teenager. If someone shows me something, I might look at it and think about it and perhaps I'll want it, but if someone were to say: "Look at this. This is what you need." Then I think I almost wouldn't be able to see it anymore, just because my attitude would be very aggressive from the beginning. But

it's really not because I don't want people to show me things, it's because I don't want them to show me something because they think it is good or that I should have one. And it doesn't matter if it's one of my best friends. I can't stand it. I just go – no!

But if someone said: "You'd look great in that sweater!"

I think I would react in the same way. I prefer to do the shopping myself. I've also been thinking that maybe it's some kind of handicap syndrome or something, because I think it's really hard to say no. When I was a kid and someone told me about an assistive device and I said I didn't want it, their reaction was always: "Oh!" They were offended.

You seemed ungrateful.

Yes, because they thought it was great. "Christ, you're stupid."

"Have it your own way?"

Yes, exactly, and that meant I wasn't allowed to take the initiative. "I see, what would you like instead?" They would just say: "Oh!" What's really frightening about it is that I'm an adult now, and I'm still in the same position, because when I deal with the health services all I can do is sit there and they still take advantage of that. Very rarely do I feel that people respect me as an adult who is in charge of my own life. Their attitude is more like this: "Well, we can give you this." And when I don't want it, they just say: "I see. Well, in that case you might as well leave." They still do that, instead of finding out what it is I do want. I'm still someone who should be grateful for all the help I'm getting from the health care services. The more I think about it, the more... It's outrageous. It makes me really upset.

6.4 The Manus Manipulator – a Step Towards Independence

If you take cleaning, for example, is it ok if you only do part of the job? If you can do the dusting and picking up and tidying up, but not vacuum?

No.

Then there's no point in cleaning at all?

No, because if you didn't do the vacuuming, you wouldn't feel like you finished the job, just because you had dusted the window sill if the floor was still dusty.

But I would have done my part, and then I'd be too tired to do the vacuuming.

So doing the dusting is your job?

Not always, but in this case it would be. It varies.

Yes, exactly. It varies. But it wouldn't in my case, because I'd never be able to do the vacuuming. In your case, sometimes you can

do the vacuuming and your wife will do the dusting. And if you don't do it because you're too tired or because you've agreed that today I'll do that job while you do something else, then you've done it together. Then it's your choice, and you know that you are capable of doing it. If you don't feel like dusting, if you'd rather do the vacuuming, you can do that, but then you'll have to switch. And if you get tired, you stop because you're tired, not because you can't do it.

But wouldn't there be some point to being able to do part of the job? Or you have to be able to switch between

Of course, there's some point to being able to do part of the job, but not in that way. The way I feel, the parts shouldn't be broken up, I want to be able to do the whole thing.

If you're able to put the laundry into the machine, you want to be able to hang it up, too.

Yes.

To make it worth doing?

I know, I know, but otherwise I feel that I'm not doing anything myself. But you may say: "You do the laundry right now." And I'll answer: "No, I put the laundry in the machine. But someone else has to do the other steps, and in that case I'm still not the one who does the laundry."

6.5 Assistance Burn-out

6.5.1 Having to Explain

Lately, I've felt pretty fed up with having assistance and I've been thinking that maybe you can get assistance burn-out. It can happen in any profession and I almost never have any time off, if you look at this as a job.

You're getting burned out?

Yeah, because I'm a supervisor almost 24 hours a day. And what do you do in that situation? You can't exactly take a vacation.

(Laughing:) Perhaps I'll take a few months off right now, because I need a break.

But what you're fed up with is having another person, an assistant, who is there all the time or is it that you're tired of having to explain, now that you that you can do some things yourself?

Both really, because I was tired of explaining things long before I was able to things on my own, so I think it's more a matter of getting more and more like this (sighs)... I don't want anyone in my house. I don't want another person around. And that doesn't mean that I need to be by myself, but it's more natural for my partner to help me when he comes home from school; that's part of life ... It's almost like having guests who aren't real guests all the time. Because they're not

family. My partner came with me to school as my assistant a couple of times. It felt really strange. He wasn't supposed to be there. It's ok if he comes to see me because I want him to, but now he's there because I need the assistance. He doesn't fit in. It's the same thing at home, but the other way around. He fits in at home, but the assistants don't. It's really strange.

Do you think the Manus has reinforced these thoughts?

Not really, but I think it has speeded things up and made them stronger. At the same time, I think it is the primary reason why I've been looking for a robotic arm. I think that's why I was looking for the technology, and maybe that was also why my frustration over the fact that it hasn't given me what I was looking for reinforced my other feelings too. At the same time, I think my frustration would have been just as great if hadn't had anything at all, because then I would have had those feeling all the time. But it's also that now I can see that there is ... If I had that, and that, and that, and that. Then maybe I'd be able to do it.

The activities you want to be able to do yourself, are they the kind of things where you have to do a lot of explaining?

No, not necessarily. I think it's hard to understand for someone who doesn't need assistance, but if you're having coffee and you put your cup down you automatically take in where you put the cup. Even if I do it through an assistant: "Put the cup on the table." it never ends up where I want it. People usually don't think about things like that, but when it happens all the time ... And the worst thing is that I may do something at home and put a great deal of effort into it because I have to explain what I want, and how I want it, and when I want it, and everything, and still it's not done the way I wanted.

Even if you try to go to extremes and tell your assistant where to put the cup?

Of course, but then it's like I've put even more energy into it. If you take the cup and drink from it and put it down, you don't even have time to notice that you've actually thought about where you put it. But I'd have to say: put the cup on the table, then a little more to the left, a little more to the right, right there. Then I'd be completely exhausted from something the brain usually barely registers.

So, on the one hand, it's tiresome to explain all that kind of stuff, and on the other hand it's a drag because you don't do it (say: "a little more to the left") and then you have to accept that the cup isn't in the position you had in mind.

Yes, exactly. I have to choose, which I really don't want to do. For example, if I'm going to have a cup of coffee, I just say that I'm going to have a cup of coffee, even though I'd really like to have the cup with the flowers which makes the coffee taste so good. Then it's just too much for me: "I want that cup", "It's not here. It's in the dishwasher.

Do you want me to wash it? Do you want me to get a different cup?" And then I just can't be bothered. I just say that I want a cup of coffee. And I guess that's what I find so difficult lately. It's gotten to be too much to always do something that's not really what I want, and that's what I do almost all day. It sort of like running into a wall, no matter what you do you can't get through it. At the same time as I'm thinking: "Christ, this is bugging me. It's so hard." I might think: "God, this is fascinating! How strange. How do other people manage? What do they think? What do they do?"

6.5.2 Who Does the Cooking – and Why?

Sometimes, I would do the cooking. I never do anymore. My partner does the cooking, because he enjoys it, and he's better at it and I don't have to get involved. When he cooks I don't get disappointed or sad or angry or upset because it doesn't turn out exactly the way I wanted it to, because then it's his meal.

And you don't mind eating it.

Yes, exactly. And that's how it is, if you make dinner for me it's really nice and enjoyable to be invited and if I want to make dinner for you I want it to be the way I had planned, and it can never be that way when I don't do it myself, because there are so many tiny details going through your mind that you're not even aware of. That's what's so exasperating.

Do you say that you have done the cooking even though your assistant did the actual physical work

Sometimes, because if I feel that I have cooked a meal then I say so, and I feel that way if I've told my assistant exactly how I want it and managed to do it without taking in any words or anything. Because it's inevitable that the assistant will say: "I usually do it like this. Why don't you do it like this? You can do this instead." If I've managed to stay clear of all that and if I've been in control of the entire process, then I feel that I did the cooking. And then I say so. My partner is quite sensitive about stuff like that and he prefers to do the cooking because otherwise he's constantly thinking about how it would have turned out if I had done it myself.

What do you mean?

He thinks that it's never the same thing if I cook through someone else, because that person will not use exactly the same amount of salt as I would have done.

So he thinks it's hard when you cook dinner because it doesn't turn out exactly the way you wanted it to?

Mmm. And then he can tell that I don't think it turned out the way I had planned. And he has an image of what he thinks I would and wouldn't do, and it's not certain that it's the right image. But some parts may be true. We don't know. Neither of us knows that, because I may have one image of what I think I would do, but if I was

actually able to do it I might not want to do it that way. If we were going to eat, I would set the table in a certain way or I would have told someone to get me the things I needed: "Get me two knives, please." And when the assistant brought them, one of the knives would be dirty. Then he feels that I would have noticed, but perhaps I wouldn't have. He doesn't know, of course, but he thinks so, And then he, too, feels that: "This is someone who is working here." Because the assistant does not put the same effort into it as she would have in her own home. It's impossible. I don't when I at someone else's house.

So he doesn't think it's as nice?

No. He wants my feeling, and he can't have that. And I can feel it, too, and do I think I convey my feeling to him, because I'm very much a person who wants to do it her way. Then it doesn't matter if it's a complete failure, because then I'm the one who made a mess of it.

But now that you're using the Manus and you want to put a cup down or whatever exactly where you want it, you know that it may end up in a different position. You don't do a lot of adjusting then, do you?

I might. Sometimes I might not have the time or the energy to make the effort. But sometimes I do, and another person can't know that. So it's a matter of what mood I'm in or how I'm feeling at the time or what I want to do and I can never convey that to another person, but I can convey it to a robotic arm, because I control it.

6.6 What Does the Term "Useworthy" Imply?

6.6.1 Is it Possible to Know if Something is Useworthy Before Trying it?

Did you know or did you think that the Manus manipulator would be useworthy to you before you had tried it?

Yes, I did, but, naturally, I didn't know what it looked like, but I did think a robotic arm would be worth using for me.

What are you evaluating when you say that the Manus manipulator is worth using?

What it's like to use it. That's why it's worth using. Because that's it. I mean, I can have an idea of whether something is usable. I can have idea of whether something is worth using, too, but then I must first see it in use.

So that you'll know the advantages and disadvantages of using it?

Yes, well, I really don't know that until I've tried it, but what I mean is that if I come here I can see the Manus, I can watch you use it. I can see what it can and cannot do, and I can form an opinion, an

“evaluation opinion” of whether I think it will be worth using in my case.

Because those activities are your priorities and you can see that the Manus can do some of them?

Yes, that’s it. I can have an opinion of whether it’s worth using without having tried it, but I don’t think I would ever believe that it’s worth using without having seen it because, in that case, I would only be able to decide if it’s usable. Do see what I mean?

Yes, I think so. It sounds as if you can decide or believe that it will be worth using just by seeing someone else use it, and by finding out about its advantages. Then, if you try it and discover the advantages for yourself, is that enough to say that it’s worth using? But what if it has many drawbacks, such as mobility problems or bulkiness or almost not being able to use it because it’s impracticable?

But that’s what so individual. I mean, I can never know, but I can believe that it’s worth using, because I can see how big it is and I can see what it can do, or at least get an idea of what it can do. Then, when I’ve used it for a while I may or may not think it’s worth using.

If it’s not worth using anymore, it’s either because the advantages weren’t so great or that the drawbacks were greater than you had expected, for example that it tired you out or that you couldn’t move the wheelchair.

To me, talking about advantages and drawbacks seems more like an evaluation of usability, because it’s really not about advantages and drawbacks, it’s about how I value it, and it may be that the robotic arm has thirty disadvantages and one advantage, but the one advantage may be just the thing that I value higher than anything else and, in that case, it’s still worth using.

6.6.2 Advantages and Drawbacks on Different Levels

	Advantages	Drawbacks
Value level		
Practical level		

Figure 6.3
Håkan draws a figure in the air about advantages and drawbacks on different levels.

When you talk about drawbacks, they are often on a practical level. It’s too slow, it’s not powerful enough, the color is wrong, the menus are hard to understand or it weighs the chair down. But when you talk about advantages you’re not talking about the practical details: that it’s actually capable of lifting two kilos, or that it’s stable or looks good, it’s more about what it can offer you:

independence or the ability to carry out tasks that are important to you.

It depends on what you're like as a person, because I don't do that. I think in terms of advantages and drawbacks, about the practicalities. It's an advantage that it can lift the glass, it's an advantage that it can reach high up, or it's an advantage that it's black. That's how I think.

Can you see any advantages or disadvantages on the value level?
I was just thinking about whether I can see any disadvantages.

Perhaps it's more about dependence and independence that you ...

But it's quite interesting. Are there any disadvantages? I mean if you look at the different levels, are there any disadvantages on that level?

Yes, I think so. I can probably think of a few. That box can't be empty. Social isolation. Would that fit in the box? You get an assistive device so that you can become independent, so that you don't need to see people.

But that doesn't make sense. That's crazy. In that case, you would be completely isolated because you're able to pick things up by yourself, eat, drink, and get dressed by yourself. Are you? I mean: Wait a minute! It's ridiculous. It's so funny. It's so stupid. It's the other way around: having assistance makes people socially isolated. All the people I know who have some kind of physical disability, and that's a lot of people, almost everyone I know, organize their lives to fit their assistants. So I mean, what makes someone socially isolated? If anything, that kind of life does. Håkan, you can do everything yourself, so you can't just sit around at home. That'll make you socially isolated. You'll feel horrible. But if you hadn't been able to manage on your own, you would have had three or four assistants coming to your house. Then you wouldn't need to go out. You could sit on the couch all day because you will have a social life anyway. But I don't think it's very social. I still think you would be socially isolated.

Are there any disadvantages on the value level?

Well, I'm sure there are, but I can't think of any.

Has it made you more dependent on others?

Because I have the Manus? No.

Suddenly, you need someone to lift it on and off.

Yes, but I need someone to help me get in and out of the wheelchair, too. What I mean is that, basically, it depends on your personality, because if I had long list of drawbacks in that box, I wouldn't still have the Manus, would I? I wouldn't even want it. I wouldn't get it in the first place. So why do something to fill that box? You don't – so there's nothing there. Because it only takes one thing.

But there are advantages and drawbacks on a practical level?

Yes, but that's different. On a practical level it's possible to make an evaluation of the number of advantages and disadvantages, and that's what it feels like with those advantages, that's why they are worth more, and then you get to the next level where it gives me something which is more or less important to me, but really, if you think about it, it's enough to have one drawback in that box for me not to want it.

You think so?

Yes, I do. Those advantages and disadvantages don't cancel each other out. It's not possible. I'm entirely convinced of that. You can't give me more and more independence if, at the same time, I'm afraid of injuring myself. That doesn't make me more independent, because I get nervous and that makes me dependent. So it's impossible. It's on a different level entirely. It's impossible to live with those drawbacks and still feel good. As soon as there is one drawback in that box you feel horrible, because it's not about whether the manipulator is bulky or not, it's your self-esteem that's at stake. It's about your feelings. It's much, much bigger. Yes, I think one drawback is enough. It makes you feel bad and, in that case, it cancels out all the advantages. I think it's a circle. I don't think it's possible to compare advantages and disadvantages on that level because it's a circle and it's all interrelated.

The fact that your arm gets so tired from using the Manus that you can't move the wheelchair and you lose that freedom, that it interferes with your ability to get around – should that be included in the box?

Well, to me that's more of a practical problem. Controlling the Manus has made me feel weaker sooner, but it probably would have happened anyway. That's my view anyway. It has meant that I have used it a lot less for a period of time. If someone came up with a good way of controlling it, that wouldn't be a problem anymore, so I can't put that I mean it's quite interesting, because I think it's somewhere in between. Either it's a practical problem – controlling the robot – or else it becomes a problem if it limits my freedom, and then I wouldn't use it at all anymore. That's what I mean. As soon as it becomes a drawback on that level, I just don't. And it's quite interesting how we value things differently, and why, because all people put a value on things, but what is it that makes you see negative things on that level so quickly and you don't see ... If I were a different person, I would probably be able to put a whole bunch of things in that box and then I wouldn't use the Manus. I'm thinking about the fact that some people haven't wanted it because of the way it looks, and I don't think that is a practical drawback, so I'd like to ask them some more questions, because I don't believe that.

Do you think they have put some disadvantages in your empty box?

Yes. I do. The Manus could have a million drawbacks but as long as it has positive aspects on the other level, you still want it. So they must have some drawback in that box. And that's what I'm curious about: what is it? And how are they thinking, in that case? It must depend on your situation. How you see things. What your attitude is. Right now, having assistance really bothers me. And it's also because it makes me feel more dependent. I thought it would be the other way around. And that makes it a really big problem. I've had such a hard time and I'm really fed up with it.

You were looking forward to having less assistance?

Yes, of course. I think about that when I'm talking to people who have assistance, and I realize that it's almost taboo. That's interesting, too. Is it because they are afraid that if they put some things in that box, they wouldn't be able to stand it and they wouldn't want assistance?

So you've started to fill that box with things that are bad about assistance?

Yes, absolutely. Absolutely. It's pretty full. It was because I couldn't think of another solution, but I will. One day I'll live in a robot. No, really ...

6.6.3 Is Personal Assistance Worth Using?

Personal assistance. Is it worth using?

Don't ask me that right now. I don't know.

Because it has to be if you're using it? That makes it worth using?

No, not necessarily. Maybe I have no alternative.

If you didn't have personal assistance, would you use the Manus more?

I'd have to.

So you can use things even if they aren't worth using?

Yes.

Because you have to? Because you're forced to.

Yes, but you can do that with "usable", too. If you didn't have a can opener, for example. If you only had a pair of scissors. Then you'd end up trying to hack the can open if you had to. You use what you've got. It's only natural.

So there is a scale? Some things can be more usable than other things and some things can be more useworthy than other things?

Wait a minute. I have to think about that. Is it possible to say how useworthy something is on a scale of 1-10? I doubt it.

So you weigh up the advantages and disadvantages on the practical level together with the advantages on a general level and you decide that: "Yes, it's worth using." You evaluate it, and then it's worth using or not?

Yes. Yes, exactly. There can't be a scale, because it's impossible for something to be "somewhat" worth using. Well, I don't know. But that makes me wonder, about my personality, the fact that I tend to see things as either black or white. That may influence how I evaluate things. It's either good or bad. I don't understand how it can be "in the middle". I wouldn't want to live like that.

Is it the fact that the Manus can do so many things that makes it worth using? If it could only do one thing. If it was only capable of picking things up from the floor?

Yes, it would be if that's the one thing I need. A carpenter can't say how useworthy a hammer is on a scale of 1 to 10. He may think that something is more or less usable, but if it's worth using, then it's useworthy. It either is or it isn't.

6.6.4 The Difference Between Usefulness and Useworthiness

What's the difference between useworthy and useful? If the Manus is really useful to you, does that make it useworthy?

If it's useful for picking up a glass, but I don't think that's important, then it's not worth using.

Useworthy, is it about how well the things the Manus can do correspond with what you want to do? Is that what makes something worth using? If you can use it to put a glass in the dishwasher, and that is what you want to do, does that make it useworthy? Or usable?

I think that makes it usable. Because if I want to do something, and it can do that, well, that doesn't make it useworthy, because if I were to list all the things I want to do, there would be a lot of things that I'd want to do, but some things are more important than other things and they are so important to me that it's worth a great deal if it can do those things. It's worth it even if one glass out of three breaks, it's worth all that because the Manus is worth using. If I were to tell you what I want to do, I would list a whole bunch of things, but some of them wouldn't be that important. If I had the choice, I'd do it, but

...

So it's a question of whether it can do the things that are most important to you? And it doesn't matter how well it can do them? It can still be worth using.

Yes, it depends whether it gives you the feeling you're looking for ... what you feel that you need. It may be enough that it fulfills one percent of it because it is so important, but if it's something that is not as important it has to fulfill a hundred percent or ninety-nine percent to be worth using.

Say that it would enable you to make coffee, but it would take five hours. That's a scale. On some occasions it would be worth

using but on other occasions it wouldn't, depending on how long it takes?

No. To me it would always be worth using, but it wouldn't be usable in every situation. It wouldn't be usable if I had people over for coffee who couldn't wait five hours. Whether something is useworthy or not doesn't change. Well, it might, but it doesn't change very easily. It's not about how often or when or how much, it's about whether it gives me that feelingIt's not knowing that I have it that makes it worth using, it's just the feeling I have that it's so important for me to know that it's there. It's more an emotional thing than a practical rational thing. It's much more about a feeling. And that's what I'm looking for.

6.7 Using the Manus Manipulator – Three Decisions

Using the robot. I see it as three steps, or three decisions. One decision was that you realized you wanted the robot. The second decision is wanting it to be hooked onto your wheelchair just to be prepared, but I think you would probably want to attach it to the wheelchair even if you're not sure whether you'll use it. The third decision is wanting to use it in a practical situation. You must want to make all three decisions, if you're really going to use the Manus. If you're in Göteborg and you're going to Malmö, do you think about whether you want to bring it or not?

Well..., the three decisions you wrote down... Are they in the right order? I mean the way you put them: one, two, three. I would like the order to be one, three, two, because if I'm not going to use it, if I don't intend to use it, I would never want to hook it on. It's not that easy to bring along. It's too bulky for me to want to attach it if I'm not going to use it.

Has it ever occurred that you wished you had brought it?

Once, maybe. I think it was because I wished I'd brought so I could show it to someone. I'm so used to knowing approximately what's involved in different activities. I know what I'll need on a certain day. I know what's involved if we're going somewhere and we're going to do certain things. I'm so used to having to plan ahead, so I know if I'm going to use the Manus or not, but as long as it's attached the way it is....Because otherwise I don't think I'd even unhook it.

So it doesn't matter how long it takes to use it, what matters is how bulky it is?

Mmm.

If you didn't bring it and you were going to have coffee, would you think: "I would really have liked to be able to drink the coffee

on my own, but it still wasn't worth it to bring the Manus just for that?"

No, in that case I would have brought it along. I don't know if that's the difference – that it's worth using, because as soon as I have evaluated it and decided that it's worth using, that never changes. Then all the inconveniences don't matter, and that's what I mean when I say that it's worth all the physical disadvantages, because it gives me that feeling, and that's very important to me for all kinds of reasons. So I would have taken it, but it also depends on, quote, "the company" I'll be in. If my family is helping me drink coffee while we're having a conversation, it's only natural and nobody even notices. But I want to use the Manus when I'm having coffee with you and I want to talk about private matters. Although I know that my assistant is next door, she's busy doing her own stuff. She's reading and I think that even if she can hear what we're saying she's not really listening, she too busy with her own stuff. But if she's sitting here, waiting for me to need help with all kinds of things, then her attention is focused on me, and she is fully aware of what we are saying.

6.8 What Do Other People Think of the Manus Manipulator?

What questions would you like to ask of other Manus users?

I'd like to ask questions of a lot of people. But I have so many questions that I can't think of them all right now. I'd like to ask those who are not using the Manus what their most important reason was for making that decision, what the negative aspects were, and what they were looking for, what they thought they would use it for, and how important that is to them. If they say that they thought they would become more independent or be able to be by themselves or something, then I'd like to know how important that is to them. If they say that it's very important, then I'd like to know why they didn't get the Manus. Then there would be a lot of questions depending on their answers, because I know what I'm looking for. I want to know how they think. So, I would have a lot of questions once I started to talk to them. It would mostly be about "why", because I want to know their reasons. To be able to compare them with mine. I'd like to ask those who use it a lot why they use it and what they used to have instead and how they use it, in what type of situations, how long it takes for them to do things with it, and if they have made any modifications at home to enable them to use it. And how valuable it is to them, and why they think it's so valuable, and what they are looking for. Is their objective to become independent or do they want to be able to do things on their own or be by themselves or don't they have a choice?

What reactions and comments have you had from other users, relatives, friends, and assistants?

Most of those who are independent think it's really cool. "Wow, that's cool, and it can do all that, and that's neat," and most of those who need help mainly see the drawbacks. "Well, its bulky. It's so slow."

You said you thought other people who have personal assistance might think the Manus was no good because they don't want to believe that their personal assistance is bad, or that it's wrong for them to have personal assistance instead of a robot like you have?

Yes, I think there is something in that, because I always get comments about how good it is to have personal assistance instead, and that it's faster and the assistant does all these things. I think many people find it difficult to say that the Manus is good because then they would realize that they want to do more things themselves. And they don't want to realize that, because it hurts.

Have you received comments like these: "Why should a disabled person like you get expensive equipment like that?"

I've heard comments, not to my face, but a friend told me that her friends had said: "Well, it must be taxpayers' money." But nobody has said anything directly to me. Nobody who has seen it has said anything. But, on the other hand, I don't think people think that way. First of all, I don't think they are aware of how much it costs and, secondly, if they did know, they would probably think: "Well, it's like a car, and that's always useful."

But does everyone respect your choice, or do they question it?

I haven't had that type of discussion, but I probably would have if I told someone who has assistance that I would like to have the Manus instead of assistance, but it's never been on that level, it's been more like this: "Well, I guess it's nice if you want it." But if I had been more on my own and used it and achieved more of the things that I want to achieve, then I think that I would get more comments and criticism, because then it would be a threat to their whole assistance life style.

Have you thought about the fact that now that there is more information available about robots, politicians might call for reductions in personal assistance?

No, but that's normal, all that stuff about what politicians say, and what they cut back on and what they don't cut back on. It has always been varying. And that discussion I feel that I can take. So I'm not worried about that. But I also think that a person who is a bit less stronger in the arms should need less assistance. I think so. And I think that maybe they wouldn't take that discussion very seriously, but since I'm not able to operate it properly by myself, I would be prepared for that discussion.

7 Simplified Use of Directly Controlled Robots

By studying the comments of the Manus test users and by observing how they use the robot, I have identified a number of problems associated with the use of wheelchair-mounted, directly controlled robots. In this chapter, I will describe beginner's mistakes, attributable to the user's inexperience, as well as difficulties which remain after the user has learned how to use the Manus manipulator.

I will also present an idea of how the use of directly controlled robots can be simplified. In order to simplify robot use it is necessary to limit the flexibility of the robot when carrying out common tasks.

The flexibility of a robot must be high to allow users to position and orient its end-effectors as desired. The positioning requires three degrees of freedom (translations along the x-, y- and z-axes) and the orientation of the end-effector in a chosen position requires another three degrees of freedom (rotations around the x-, y-, and z-axes). To achieve this flexibility, the robot must have six joints. The first three joints enable the end-effector to assume the desired position (x, y, z) and the other three joints (yaw, pitch, and roll) determine the orientation of the end-effector in this position. Any additional joints increase the work space and accessibility of the robot. The Manus manipulator has seven joints, the seventh joint being capable of raising and lowering the whole robot to enable it to reach the floor and high shelves.

It is difficult for a person with a physical disability to control all these joints, even though it is not necessary to control the Manus manipulator joint by joint since it can be controlled in straight lines along the x-, y-, and z-axes. Preprogrammed robots are one way of simplifying robot use. The drawback of these robots is that they cannot operate in an unstructured environment or when they are mounted on a wheelchair. Controlling the orientation of the end-effector is particularly difficult. (Consider how difficult it is for an experienced lecturer to turn an overhead picture the right way.) Movements requiring precision are also difficult and time-consuming.

Although, in principle, the robot must be highly flexible to allow the end-effectors to assume a desired position and orientation, in practice its flexibility is limited by gravitation, the shape of the objects which it is handling, the design of the end-

effector, and the task it is performing. It is possible to find out what these practical limitations are by identifying the most common tasks for which the Manus is used. By effecting the corresponding temporary and situation-dependent limitations to robot control, robot use can be simplified without further reducing the flexibility of the robot.

In this chapter, I will provide examples of common tasks, identify the movements of the robot and the objects handled in connection with these tasks, and evaluate the degree of difficulty of the tasks. Finally, I will discuss how various help functions such as automatic grasping, preprogrammed 90° orientations, and a Tool Center Point function can be evaluated to determine the degree to which they simplify robot use.

7.1 Difficulties of Using the Manus Manipulator

During the trials of the Manus manipulator and Eva Gerdén's initial use of the Manus manipulator I observed the following difficulties (see also under 5.2.4):

- Test users had difficulty planning the order in which to carry out the steps of the task. For example, some users got the pitcher out of the refrigerator before getting the glass from the kitchen cupboard, which meant that they had to put the pitcher down on the table to be able to get the glass. This took so long that it was necessary to close the refrigerator before grasping the pitcher again to pour the drink. Finally, they had to put the pitcher down again to open the refrigerator before putting the pitcher back. One way of reducing the need for planning a task is to reduce the time it takes to carry out each step of a task. Then it would matter less in which order the steps were carried out.
- At first the test users found it difficult to determine where they should grasp the pitcher to be able to pour without risking that the robot would drop the pitcher. It is necessary to analyze the design of the end-effector, especially when it comes to handling heavy objects, such as pitchers and binders.
- Some of the users poured the beverage from the pitcher into the glass in an awkward way. The reason was probably that the Manus manipulator was mounted on the left-hand side of the wheelchair while the users were right-handed. The task became more difficult because visibility was reduced as a result of how they poured the beverage. When Eva Gerdén's Manus manipulator was moved to the right-hand side of the wheelchair, where the joystick of the wheelchair is located, the

manipulator was in the way when her assistants needed to assist her with something since the assistants, who are right-handed, usually work from the right-hand side of the wheelchair. It is important for those people who adapt the Manus manipulator for the wheelchair to be aware of this.

- The range of the Manus manipulator is rather short and at first the test users moved it to its end stops, i.e. to a completely extended position. Instead of retracting the manipulator and moving the wheelchair closer to the table, they carried out the fine positioning by means of the wheelchair. This was difficult because the weight of the robot meant that they were forced to make large movements with the joystick and, consequently, the wheelchair moved quickly once it started moving. The limited range of the robot also meant that it was difficult to see the objects it picked up from the floor since the objects had to be close to the wheelchair to enable the robot to reach them. These difficulties can be reduced by increasing the range and reducing the weight of the manipulator.
- The test users dropped objects because they did not know the grasping force of the end-effector. The location of the joystick was not satisfactory, and, moreover, the grasping movement was on the same menu as the vertical movement, which meant that the users reduced the grasping force by mistake. A force sensor in the end-effector, providing either visual feedback to the user or automatically ensuring that the grasping force is maintained, would be useful.
- Initially, the test users used the wrong menu. They had problems finding the menu for changing the orientation of the end-effector and they also left the menu they were currently in by mistake, particularly when adjusting the position of the end-effector. Instead of slowly moving the joystick in the right direction until the robot slowly begins to move, they effected a short, quick movement of the joystick. This short, quick movement is used for returning to the main menu. Furthermore, there is a short delay before the robot begins to move. When the robot failed to move, the users moved they joystick even more, causing the robot to move too quickly. It should be possible to eliminate the possibility of returning to the main menu by means of the joystick if alternative ways of returning to the main menu, such as pressing a button, are used.
- The test users had difficulty changing the orientation of the end-effector from vertical to horizontal. They placed the end-effector at a 90° in the wrong direction and then tried to find a different menu which contained the desired movement. They had less difficulty changing the orientation from horizontal to

vertical. (An analogy would be that it is easy to go from the equator to the south pole, you only have to go south, but if you are going north from the south pole, you do not know where on the equator you will end up.) For example, a videotape and a straw, which are grasped from above, must be angled differently. The videotape should be angled so that it will be in the horizontal position, making it possible to insert it into the VCR, while the straw should be vertical so that the user can put it into a glass. An experienced user first angles the end-effector and then makes the necessary corrections if, for example, the straw ends up in the horizontal position. A number of preprogrammed 90° orientations for the pitch and roll movements of the robot would facilitate robot use.

- The users found it difficult to position the end-effector accurately, both horizontally and vertically. The orientation of the end-effector was often slightly wrong, making the task of grasping a glass of water or inserting a videotape more time-consuming. In this case, too, a number of preprogrammed 90° orientations for the pitch and roll movements of the robot would facilitate robot use.
- When moving the glass from the table to their mouth, the users found it difficult to maintain the horizontal position of the end-effector. This was due to the fact that the yaw and pitch movements were on the same menu. When they turned the glass towards their mouth, they sometimes tipped it upside down. The yaw and pitch movement should be placed in separate menus when a joystick is used for controlling the Manus manipulator.
- The users also had difficulty pouring from a pitcher because the Manus manipulator does not have a Tool Center Point function, TCP, which would make it possible to rotate the pitcher around its spout. Instead users are obliged to change the position of the pitcher several times during the pouring movement, making it necessary to change menus a number of times. The absence of a TCP function also meant that it was difficult to open a book or use an instant coffee dispenser with a sliding cover located on the outer edge of the cylinder-shaped container. A TCP function, where the user can move the TCP of the end-effector would facilitate robot use.
- It was not possible to stir sugar into a cup of coffee or to stir a pot using the Manus manipulator because the manipulator was too slow. For these tasks, it would be sufficient if the speed of the manipulator was high within a limited range. Another alternative is to develop a fast stirring function.
- The acceleration of the robot was too slow to enable a user to turn over meatballs in a frying pan or to the shake cake mix

out of a package. High acceleration is only required within a limited range. Functions should be developed for achieving quick jerking movements and shaking movements.

7.2 Common Tasks and the Movements of the Robot when Carrying Out these Tasks

In the following analysis I have chosen to designate the tasks listed in Table 7.1 as common tasks. These are the tasks carried out by the test users in the Manus manipulator trials (see Section 5.1.4). For a more detailed analysis comprising more tasks I refer the reader to other trials of the Manus manipulator (Stanger, Angelin, Harwin and Romilly, 1994). I also recommend that a detailed study be carried out of the tasks performed by Manus users.

In order to assess the degree of difficulty of various tasks I divided them into twelve steps. I subsequently assessed the degree of difficulty of each step and assigned it a weighting. The total degree of difficulty of a task is obtained by adding up the degree of difficulty of each step, see Table 7.7. I estimated the weighting on the basis of experience from the user trials, which are described in Chapter 5, and from my own use of the Manus manipulator. The tasks are listed in ascending order of difficulty.

I used three bases of division for the analysis: Firstly, the movements of a robot when handling or manipulating an object can be divided into three main movements: Grasping, transferring, and inserting. Grasping comprises assuming the grasping position and grasping the object. Transferring comprises moving the object from the grasping position to the releasing position, possibly by following a predetermined path, and inserting comprises adjusting the object in the releasing position and releasing it. In the case of simple tasks, such as pressing a button, it is not necessary to carry out all three main movements.

Secondly, each of the three main movements can be subdivided as to whether they involve changing the position or the orientation of the end-effector. When carrying out simple tasks it is only necessary to change the position of the end-effector. Thirdly, the degree of difficulty of a task also depends on whether the task requires the robot to carry out the movements with precision.

Activity	Without precision				With precision				Total degree of difficulty				
	Grasping		Transf.		Inserting		Grasping			Transf.		Inserting	
	Pos	Ori	Pos	Ori	Pos	Ori	Pos	Ori		Pos	Ori	Pos	Ori
Weighting	2	5	1	4	2	5	3	7	6	8	6	10	
Pressing a large button					x	x							7
Picking up objects from the floor.	x	x	x		x								10
Getting a book from a bookshelf	x	x	x		x	x							15
Turning a dice	x	x	x		x	x							15
Picking up a straw and putting it in a cup	x	x	x		x	x							15
Pressing a small button											x	x	16
Turning a knob							x	x		x			18
Opening a kitchen cupboard	x			x				x	x				19
Opening a refrigerator	x			x				x	x				19
Opening a door with handle				x			x	x	x				20
Putting a videotape into a VCR	x	x	x								x	x	24
Turning the pages of a newspaper				x	x	x	x	x	x				27
Turning the pages of a book				x	x	x	x	x	x				27
Turning the pages of a binder				x	x	x	x	x	x				27
Opening a bottle with a bottle opener		x			x	x	x		x	x			29
Drinking from a bottle					x	x	x	x	x	x			31
Drinking from a glass					x	x	x	x	x	x			31
Pouring from a teapot					x	x	x	x	x	x			31
Pouring from a pitcher					x	x	x	x	x	x			31
Locking with a key		x	x				x			x	x	x	33

Table 7.1 Common tasks divided into twelve steps and listed in ascending order of difficulty. Each step has been assigned a weighting. The higher the weighting the greater the degree of difficulty. An X means that the step is necessary in carrying out the task.

7.3 Common Objects

Table 7.2 is a list of the objects handled in connection with the tasks in Table 7.1. The objects are divided into the following five categories depending on their shape and function: cans/bars, boxes/discs, push-buttons, knobs, and handles. By expanding the analysis to include more common objects and by studying the gripping surfaces of the objects and the movements the robot must carry out to grasp the objects, it is possible to develop better end-effectors and to identify suitable limitations of robot control.

Object	Cans/Bars	Boxes/Discs	Push-buttons	Knobs	Handles
Glass	X				
Handstick	X				
Bottle	X				
Straw	X				
Dice		X			
Keys		X			
Newspaper		X			
Videotape		X			
Book		X			
Binder		X			
Bottle opener		X			
Remote control			X		
Button			X		
Knob				X	
Pitcher					X
Cupboard handle					X
Refrigerator handle					X
Tea pot					X
Door handle					X

Table 7.2 Common objects divided into five categories depending on their shape and function.

7.4 Examples of Simplified Robot Use

Three ideas of how robot use can be simplified are described below. In addition, the test users made suggestions for purely physical improvements, such as a slimmer and lighter arm, an attachment for the Manus behind the wheelchair, longer range, greater lifting force, reduced backlash, higher speed and acceleration, see Section 5.2.4 and my suggestions in Section 7.1.

7.4.1 Automatic Grasping

The trials described in Section 4.7 showed that two thirds of the time it took to grasp an object was spent adjusting the position of the end-effector. In these trials, it was not necessary to change the orientation of the end-effector, which means that normally an even greater part of the total grasping time is spent adjusting its position. Consequently, an automatic grasping function would reduce the time spent on the grasping movement. The user would control the robot manually until it comes close to the object it is to grasp. At this point, the automatic grasping function would start, using sensors to determine the exact position and orientation of the object. The requirements for the automatic grasping function can be reduced if it is only used for common objects and tasks.

7.4.2 Preprogrammed 90° Orientations

Table 7.2 shows that, when carrying out common tasks, the robot handles objects which resemble cans, boxes and handles. Because

of gravitation, cans and boxes are placed so that they can be grasped directly from above or from the side. Consequently, it would be easy to grasp objects shaped like cans or boxes if the pitch and roll joints of the end-effector could be positioned at even 90° angles in a simple way. Handles oriented horizontally or vertically could also be grasped using this function.

One possible solution is based on three buttons. One button is used to position the end-effector vertically and two buttons are used to position the end-effector horizontally. Two buttons are required for the horizontal position since the end-effector can be positioned to open the grasping fingers vertically or horizontally. In both cases, the end-effector is positioned facing away from the user. This function should be implemented in a way that will permit e.g. a videotape that is in the horizontal position, but upside down, to be turned over. This can be effected by using a fourth button to rotate the roll joint through 180°.

7.4.3 Tool Center Point

The Manus manipulator does not have a Tool Center Point function (TCP) which, for example, would enable the robot to rotate a pitcher around its spout. Tasks where a TCP function would make the robot easier to use include pouring or drinking, opening a book or a door, inserting diskettes or videotapes, and other tasks where the end-effector must follow a circular path.

The present Manus manipulator has a drinking function which works fairly satisfactorily. It carries out an upward movement while turning the glass. A drawback of this function is that if the user holds the glass low down while drinking, which may be necessary to avoid the fingers of the end-effector, the rim of the glass will press against the user's mouth while he is drinking.

To ensure that a pouring movement can be carried out quickly and easily with the aid of the Manus manipulator, the TCP function must be combined with the movement the robot carries out when pouring. The following is an analysis of the pouring movement normally carried out when pouring from a pitcher into a glass placed on a table. It turns out that the pouring movement is more complicated than just rotating the pitcher around its spout. The movement is started by lifting the pitcher a short distance from the table and tilting it slightly to place the spout above the glass. Subsequently, the pitcher is rotated round the spout at same time as it is lowered so that the spout moves towards the glass from above. When the spout is just above the glass, the rotation continues around the spout without the pitcher being lowered any further. The pouring movement is completed in the reverse order. Before installing any sensors capable of detecting critical

measurements one must first analyze common glass and pitcher sizes and necessary variations of the movement.

It must be easy for the user to change the TCP of the robot. One way is to use environmental docking (Kwee, 1998), which, for example, can be used for opening a cupboard door. First, the Manus manipulator is placed close to the two hinges of the door, i.e. two points on the axis around which the end-effector should move. Next, the robot grasps the handle of the cupboard door and carries out the circular movement around the hinges. Another alternative is for the user to set different TCPs by gradually moving the TCP in the x, y, and z directions relative to the end-effector, and yet another alternative is that the robot detects the orientation of the end-effector at the beginning of, for example, the pouring movement. The orientation of the end-effector may indicate whether the robot is to carry out a pitch movement or a roll movement.

7.5 Analysis of Simplifications

In order to determine how good the suggested help functions are, I have analyzed the common activities listed under 7.2. I have decided that, to the extent that they are applicable to a certain task, the help functions eliminate the precision requirement as indicated in Table 7.3. For example, an automatic grasping function changes precision grasping into grasping without precision with respect to position as well as orientation.

	Without Precision			With Precision			
	Grasping	Transf.	Inserting	Grasping	Transf.	Inserting	
	Pos	Ori	Pos	Ori	Pos	Ori	
No help function				X	X	X	X
Automatic grasping	X	X			X	X	X
90° function		X		X	X	X	X
TCP		X	X	X	X		X

Table 7.3 The help functions automatic grasping, 90° function, and TCP eliminate the precision requirement for the movements of the robot as set out in this table.

Table 7.4 shows how much easier it is (in per cent) to carry out the tasks with the help functions separately and by combining them. Only the combination of the 90° function and TCP has been included, since they are easier to implement than automatic grasping. The No Help Function column in Table 7.4 is the same as Total Degree of Difficulty in Table 7.1. The last row of the table shows the average reduction of the degree of difficulty for all the tasks.

Activity	No help function	Reduction in the degree of difficulty (in per cent)				All help functions
		Aut grasp.	90° TCP	90° + TCP		
Pressing a large button	7					0%
Picking up a handstick from the floor	10					0%
Getting a book/binder from a bookshelf	15					0%
Vända tärning	15					0%
Getting a straw and putting it in a glass	15					0%
Pressing a small button	16					0%
Turning a knob	18	17%	11%			17%
Opening a cupboard	19	11%	11%	11%		11%
Opening a refrigerator	19	11%	11%	11%		11%
Opening a door with a handle	20	15%	10%	10%		15%
Putting a videotape into a VCR	24		21%	21%		21%
Turning the pages of a newspaper	27	11%				11%
Turning the pages of a book	27	11%				11%
Turning the pages of a binder	27	11%				11%
Opening a bottle using bottle opener	29	3%		31%	31%	34%
Drinking from a bottle	31	10%	6%	29%	35%	39%
Drinking from a glass	31	10%	6%	29%	35%	39%
Pouring from a tea pot	31	10%	6%	29%	35%	39%
Pouring from a pitcher	31	10%	6%	29%	35%	39%
Locking with a key	33	3%	15%		15%	18%
Average reduction in the degree of difficulty		7%	5%	7%	12%	16%

Table 7.4 The table shows how much easier it is (in per cent) to carry out the tasks with the help functions separately and by combining them.

This analysis shows that automatic grasping and TCP is the help functions which simplify robot use the most in connection with these tasks. If the 90° function is added, the robot becomes even easier to use, since TCP and the 90° function simplify different steps of a task. An automatic grasping function in combination with the 90° function would not be as useful since the 90° function simplifies the same tasks, with one exception, and the same steps as automatic grasping.

In this analysis the degree of difficulty of the tasks is assessed, which is not the same thing as the time required to complete the task, since the time required is influenced by other factors, e.g. the distance the object is moved, the visibility of the manipulator, and how close to the end stops of the robot the user is working. However, there is a correlation between time and degree of difficulty.

A weakness of the above analysis of the degree of difficulty of the tasks is that the weightings are estimates. However, I have tested other weightings and the order of difficulty of the tasks turned out to be the same, which indicates that the approach is not sensitive to small variations in the weightings.

The simplifications I propose increase both the usability and the useworthiness of robots since they simplify tasks which the test users themselves have chosen and which they thus presumably consider to be high priority tasks.

8 Ethical Issues

8.1 Rehabilitation Engineering

Research Ethics

Rehabilitation Engineering research entails many ethical issues that are seldom discussed, even though the technology involved has a considerable impact on people's lives. Moreover, it is difficult, if not impossible, to carry on rehabilitation engineering research without working closely with people with disabilities. I therefore want to openly set out the ethical issues I encounter in my research.

There are no research ethics committees directed at rehabilitation engineering or general technology, so it is usually necessary to refer to research ethics committees established within faculties of medicine. Although many applications to these committees concern issues such as animal testing, these committees are also obliged to address questions dealing with how test subjects are selected, how they are informed, the type of insurance coverage provided, and the possibility of a dependent relationship between the researcher and the test subject.

The Swedish Medical Research Council has issued a policy paper on research ethics (Medicinska Forskningsrådet, 1996) and the Council for Research in the Humanities and Social Sciences has adopted research ethics guidelines (Humanistisk-Samhällsvetenskapliga Forskningsrådet, 1990). Other guiding authorities in the area of research ethics are the Helsinki Declaration (World Medical Association, 1989), the Nuremberg Code of Conduct (Nuremberg Code, 1949), the Belmont report (Department of Health, Education, and Welfare, 1979), the reports entitled "God sed i forskningen" ("Good Research Practice") (SOU 1999:4, 1999) and "Forskningsfusk och vetenskaplig oredlighet" ("Research Fraud and Scientific Dishonesty") (Forsman, 1996), as well as the provision in the United Nations' Declaration of Human Rights concerning everyone's right to share in scientific advancement (General Assembly of the United Nations, 1948). Certec has also published a report dealing with the legal and ethical issues in Rehabilitation Engineering research (Fält and Jönsson, 1999).

8.2 Ethical Problems Associated with the Use of Robots

The aim of the development and testing of robots for people with physical disabilities is greater independence and increased opportunities for employment for people with disabilities. By analyzing the ethical issues involved, it is possible to foresee problems that may result from the research. One problem associated with the field of robotics for people with physical disabilities is that few people with physical disabilities use robots. The ethical issues involved are further complicated by the fact that there is limited knowledge of the effects of the research, making it difficult to predict the consequences of various decisions.

In this chapter, I will describe the ethical issues raised by the Manus manipulator trials, since more issues emerged in the course of these trials than in the RAID project. The Manus manipulator is directly controlled and operates closer to the user and, consequently, entails a greater risk of injury. The Manus also raises questions about the need for assistance, since it is mounted on the user's wheelchair and is thus always available.

8.2.1 Political and Social Factors Connected to Long-term Use

The purpose of robotic aids is not to force people with physical disabilities to use robots instead of personal assistance. Rather, the role of the robot should be as a complement to personal assistance for those people who wish to use one. At the time when we sent our solicitation of interest to people with physical disabilities inquiring whether they would be interested in participating in the Manus trials, there was an ongoing debate in the media about the high cost of a recent personal assistance reform. In our letter, we informed the prospective participants of the purpose of the trials in order to avoid any misunderstanding.

It is arguable whether increased independence is always a good thing. Perhaps a tool designed to provide greater independence leads to social isolation? In view of the fact that there are many independent individuals without disabilities who are not socially isolated, the risk is small in my opinion. On the contrary, with increased independence one may become more active and undertake on one's own the social activities one wishes. An example of how assistive devices can lead to reduced social isolation is a child with physical disabilities whose status improved among his peers because he was able to handle a computerized robot (Whittaker, 1992).

On the other hand there is always a risk that, to some people, an assistive device will become a symbol of their inability to manage on their own and, consequently, they will not want to use it. An assistant can be a friend while a robot has the definite stamp of an assistive device, making users concerned that other people will focus on their disability.

8.2.2 Trials

Participating in robot trials brings several advantages to people with physical disabilities. They contribute to the further development of robots in a way that is advantageous to them and they help ensure that robots are used more effectively in rehabilitation. They also have the opportunity to try out an assistive device that may be useful to them.

However, there are ethical issues that are specific to trials of new devices. Test users may believe that the robotic aid is a good assistive device for them, or that they will soon be able to get a robot as an assistive device if they wish. The fact that someone is given the opportunity to participate in the trials does not mean that a robotic aid is the best solution for that person, nor does it constitute a promise that they will be issued with their own robot. The test users were informed of this.

The videotaping of the trials is another ethical issue. It is difficult for test users to know in what contexts the videotape will be used in the future. Test users who participated in the trials agreed to be videotaped. They gave us permission to use the tapes for educational purposes.

When the test users are individuals who have recently been injured and who are experiencing a crisis, they may not be able to assess what the trials will mean. If they agree to participate, but change their mind later, they may still feel obliged to take part. During the trials, we watched carefully for any signs of this.

8.3 Physical Risks

I have drafted an agreement, setting out any foreseeable physical risks, to be used in further trials of the Manus manipulator. Test users should acknowledge that they have acquainted themselves with the agreement and undertake to inform me of any signs of danger they may discover during the trials. The agreement is based on a sample agreement included in the Certec report entitled "What is Right?" (Fält and Jönsson, 1999).

8.3.1 Co-operation Agreement with Respect to Manus Manipulator Trials

Certec is responsible for ensuring that the technical devices we develop meet reasonable safety standards. Since we are primarily engaged in research rather than manufacturing of products, there is often no prior experience to rely on with respect to the technology which is to be tested.

Certec is willing to assist the user in every way during the trials. The test user is expected to have a strong interest in carrying out the testing and to provide information about/or document the results, including reporting any deficiencies in the technology, and to use the product with care.

Certec is only responsible for injury resulting from demonstrable fault or negligence in connection with the development of the device. The Product Liability Act, the Product Safety Act, and the Consumer Sales Act are not applicable. Any claim for damages by the user should be made within five years of his beginning to use the device or within six months of an injury or of the effects of an injury becoming apparent.

The user is requested to inform other users of the product of the content of this agreement.

The user should pay special attention to the following:

- The Manus manipulator is capable of lifting a maximum of 2 kg and of grasping with a force corresponding to a maximum of 2 kg. Be careful when grasping fragile objects.
- Keep in mind that you might drop objects that you have grasped. Also pay attention to where the object will fall if you drop it. Avoid hot beverages and sharp objects, especially if you are an inexperienced Manus user.
- The Manus is controlled by means of a keypad or a joystick. If you let go of the button or the joystick, the robot stops immediately.
- When the Manus arm is moving, another person can stop the movement by holding on to the arm.
- The Manus manipulator weighs approximately 20 kg and is mounted on one side of the wheelchair. This means that you must be careful when driving on steep slopes so that the wheelchair does not fall over.
- The way you use the Manus also affects safety. For more information about safety, please read "Safety Considerations of Manus", see Appendix D.
- If you have any questions or concerns when using the Manus, please ask!

Start date of the trials:.....

I have acquainted myself with the above information provided by Certec, and I accept the terms of this agreement.

.....
Signature of test user

.....
Date

Certec undertakes to work in accordance with this agreement

.....
Signature of Department Chairman

.....
Date

8.3.2 Risk Analysis

One way of making robot use safer is to carry out a risk analysis of the physical injuries that can occur. I can foresee the possible injuries listed in Table 8.1.

Problem:	Risk:
Insufficient adaptation of technology to individual	The user's ability to move may deteriorate due to incorrect working posture. Inability to operate the control device in a reliable manner. The manipulator does not move in the way the user wants or drops objects because the user fumbles. The user gets tired, which increases the risk of error. The user touches the control device of the wheelchair with the Manus arm, making the wheelchair start moving.
Insufficient practice	The manipulator drops objects. The user gives the wrong command to the Manus. The sharp edges of the Manus scratch objects located close to it. The user is unable to operate the wheelchair because of changed driving characteristics. The user grasps objects incorrectly or so tightly that objects are damaged or destroyed.
Insufficient technical reliability	The Manus manipulator moves in the wrong direction or at the wrong speed. The wheelchair tips over on steep slopes. The Manus manipulator becomes stuck in the extended position making it impossible for the wheelchair to move. The weight and location of the Manus results in damage to the wheelchair. The Manus moves without receiving a command. The Manus comes loose from the wheelchair.

Table 8.1 Possible problems and risks with using Manus

The risk that any of these things will happen is small. The Manus manipulator moves slowly and stops when the user lets go of the joystick. It is only capable of lifting 2 kg, which means that it is not strong.

In order to minimize the effects of any error, users practice by performing safe tasks until they have gained a certain amount of experience. In order to reduce the risk of technical errors during the trials, a technical check of the robot and its functions was carried out before the start of the trials.

In this connection, one must not forget about the psychological effects of presenting the risks in an unsuitable way. The user may stop listening because he is being overloaded with information. Listing all these risks may also scare the user, which may cause him to make mistakes when operating the Manus.

9 Discussion and Conclusions

Robots offer many possibilities, but their use is limited among people with physical disabilities. The reason for this is not just that the technology is unknown among people with physical disabilities and rehabilitation professionals, it is also because there is limited knowledge about the user and the use of the technology.

Increased knowledge about the needs and priorities of robot users, the situations and tasks for which they want to use a robotic aid, and about how the robot is used in practice will facilitate the development of robots and other assistive devices which are well-suited to their purpose. Such knowledge can also be used to create new opportunities for interesting activities for people with high-level spinal cord injuries during initial rehabilitation.

In Chapter 3, I defined the concept of useworthiness as a means of focusing on the importance of a robot in the user's life situation. Useworthiness is the individual user's assessment of the extent to which the technology meets the user's high-priority needs. Two important components of this definition are the user's high priority needs, i.e. what the user wants to do, and the functionality of the robot, i.e. what the robot can do. A third component is the usability of the robot, i.e. how easily and efficiently the user can utilize the functionality of the robot.

The concept of useworthiness has helped me analyze why some individuals wish to have a robot as an assistive device and why others do not wish to use a robot. My interview with a Manus user who finds the Manus manipulator worth using shows that the usability of the Manus manipulator does not necessarily have much bearing on its useworthiness.

The concept of useworthiness can be applied to a wider field than just robots and people with physical disabilities. In my opinion, the concept of useworthiness can make visible the needs and priorities of individuals regardless of whether or not they have a disability.

A prerequisite for assessing the useworthiness of robots is the existence of robots which can be used. The meeting between the functionality of the robot and the needs of the user only occurs through actual use. The development of page-turning grippers for the RAID workstation (see Chapter 4) was a means of increasing the functionality of the robot in a work situation so that people with physical disabilities would be able to experience robot technology and influence its development in the right direction. End-effectors are of central importance to the tasks a robot can

Needs and priorities of robot users

The concept of useworthiness

Development of page-turning grippers

perform. Consequently, the design and function of the end-effectors influence the useworthiness of the robot. Highly functional and versatile assistive devices afford better possibilities for studying people's needs and priorities.

Reliability

Reliability requirements are high in user trials. It was the one factor that the users mentioned most. The results of the page-turning trials show that the reliability of the robot ranges between 40% and 100% depending on the type of book used and where in the book the pages are being turned. Hard cover books and page turning in the middle of a book have the highest level of reliability. Small positioning errors had a substantially negative impact on reliability. We should therefore have given higher priority to and spent more time on the programming and adjustment of the page-turning movements. The technical problems discovered during the integration of different parts of the system should have been solved before the trials.

The page-turning solution is based on measuring the height, width, and thickness of the book. The book is opened by inserting a hand-sized plastic knife at the upper corner of the book. The corner is the only part of the book where the pages do not fold when the plastic knife is inserted. The time required to get to exactly the right page must be shortened and it is not sufficient for the robot to move faster. A more accurate method for multiple page turning should be developed, if required in the work situation.

Single pages are turned by means of a bellow-type suction cup, which lifts the upper corner of the page. To facilitate page turning, air is blown (35 l/min) onto the edge of the of the page at the same time as the suction cup is moved towards the surface of the page and a block adjacent to the suction cup forces the page to bend when the suction cup grasps it. The airflow through the suction cup (6 l/min) is too low. In my opinion, the best way to improve page separation is to use a more powerful vacuum ejector (with an airflow of approx. 20 l/min) for the bellow-type suction cup of the end-effector. Furthermore, the parameters of the page-turning movement should be adjusted to enable the robot to turn a page more gently and with greater reliability. More tests should be carried out on different book sizes.

Automatic grasping

The RAID workstation was used by two test users to identify requirements for an automatic grasping function in directly-controlled robots. The results showed that the robot must be capable of identifying and grasping objects at a distance of approx. 100 mm. The test users were able to place the robot roughly in this position within 30 s. They spent a quarter of the time used for rough positioning on moving the robot and three quarters on changing menus. They spent a third of the total grasping time on

rough positioning (30 s) and two thirds on fine positioning (60 s). In these trials, it was not necessary to change the orientation of the end-effector, which means that, in most cases, an even greater part of the total grasping time is spent on fine positioning.

Consequently, help functions which simplify fine positioning have higher priority than functions which simplify rough positioning.

The RAID workstation has not been used as extensively as I had hoped. One reason for this is that, to a certain extent, the RAID workstation must be adapted to a work situation. Before this work situation is known it is difficult for users to assess the useworthiness of the workstation. On the other hand, in the case of the Manus manipulator, it is sufficient for the user to think about his everyday life to assess whether the manipulator is worth using or not.

The trials of the wheelchair-mounted Manus manipulator involving eight users (see Chapter 5) were carried out in order to identify tasks and situations where the Manus manipulator can be a suitable assistive device for people with high-level spinal cord injuries during initial rehabilitation and to establish what users demand from a robotic aid.

Manus user trials

Tasks which the users considered important and wanted to try include getting a binder and an environmental control unit from a shelf, inserting a videotape, pouring a drink, drinking, and picking up things from the floor, for example a remote control or the hand stick which they attach to their hand and use for many different purposes. Other tasks included picking up a newspaper which had slid down from a user's lap to her feet and pressing lamp and elevator buttons.

A technical problem mentioned by the users during the trials was that the location of the Manus manipulator at the front wheel of the wheelchair makes it difficult for them to get close enough to a table to use the remaining mobility of their arms. They also found it difficult to position the end-effector accurately both horizontally and vertically, which is necessary when inserting a videotape, for example. Examples of difficult tasks include pouring, especially when the user does not know how much is left in the container, stirring sugar into a cup, stirring a pot, frying meatballs, and shaking cake mix out of a package. High acceleration within a limited range of movement is required for turning over meatballs and shaking cake mix out of a package.

Some of the test users stated that they did not wish to have a Manus manipulator that looks and works like the present version, even though they said that it would increase their independence and improve their quality of life. They also said that they would like to have a Manus manipulator if it were more usable. The question is whether the practical drawbacks, i.e. the limited

Do the test users wish to have a Manus arm?

usability of the robot, really do outweigh the advantages on a value level, i.e. increased independence, and improved quality of life. I think that it is more likely that the most important factor is how the users view the advantages and drawbacks (if any) on a value level, for example the extent to which they value increased independence and to what extent they need to be able to be by themselves.

In-depth interviews about the useworthiness of robots are a means of moving forward in this investigation aimed at making visible the user's priorities regarding the tasks and situations for which he or she would like to use a robot. Further trials can then show whether the user's stated priorities are accurate, and more interestingly, how these priorities change.

Discussing the
useworthiness of robots

In Chapter 6, I demonstrated that it is possible to discuss the useworthiness of robots in order to make visible both the needs, wishes, and dreams of the individual and the important functions of a robot. The comments made by the user in this in-depth interview can be used in similar interviews with other individuals to obtain a more comprehensive picture of what makes a robot worth using.

The person I interviewed, who has been using a Manus manipulator for five months, thinks that the Manus manipulator is worth using, even though she is not able to use it very much for practical reasons. Her arm gets tired when she uses it. She has 24-hour assistance and appreciates every hour she can spend by herself. She is tired of explaining what she wants to do, and she must either be satisfied with a result which is not exactly what she intended or not carry out the task at all. With the aid of the Manus manipulator she can carry out the tasks the way she wants, without having to talk or explain. She has not been able to spend as much time on her own as she had hoped, but the Manus manipulator has inspired her to look for other technical devices which would make her less physically dependent on other people. She was surprised that she used the Manus for drinking coffee even when her assistant was sitting next to her.

Simplifications of robot
use

In Chapter 7, I described the experience I gained from the Manus trials and I also put forward a number of suggestions for how the Manus can be made easier to use, including limiting the high flexibility of the robot when carrying out common tasks. Since the end-effector, the shape of common objects, gravitation, and common tasks limit the need for robot flexibility, programming or directly controlling the robot can be facilitated by building the corresponding limitations into the control system of the robot, without further limiting the flexibility of the robot. The movements which are most difficult to carry out are the

movements where the orientation of the end-effector much be changed and those requiring high precision.

An automatic grasping function would reduce the time spent on making the final adjustments of the grasping movement. An analysis of the shape of common objects has shown that it is often necessary to place the end-effector in a horizontal or vertical position. A function for placing the pitch and roll joints of the end-effector at even 90° angles would thus be useful. A Tool Center Point function, TCP, would also be useful, for example when a user is pouring from a pitcher or drinking from a glass. Automatic grasping and TCP are the help functions which simplify robot use the most. Robot use would become even simpler if the 90° function were added, since TCP and the 90° function simplify different steps of a task.

Common tasks and the movements of the robot when carrying out these tasks should be studied in detail in order to develop help functions which simplify robot use.

9.1 Surprising Findings

In the course of my work I was surprised to find that despite the complexity of the problem it is possible to analyze and categorize both use functions and user priorities. It became clear what the use functions were when I isolated common movements and situations and was able to see what is required in terms of acceleration, speed, and pattern of movement. For example, the information about low acceleration requirements mentioned in Section 4.4.2 proved incorrect. It became obvious what the users' priorities were when a new tool was added to the analysis box: the possibility of investigating useworthiness.

Acceleration

I was also surprised that two of the eight test users told me almost immediately that they would prefer the Manus manipulator to be mounted on the right-hand side of the wheelchair since they are right-handed. One of them made this comment despite the fact that it had been eleven years since she had used her right hand. This may also be the reason why some of the users poured water from a pitcher in an awkward way. Right-handedness is thus part of people's way of thinking even if it cannot be implemented in their own hand.

Right-handed users

It is also surprising that the Manus user I interviewed uses her Manus manipulator even when her assistant is nearby, although this may be explained by the fact that she also uses her electrical wheelchair when assistants are present. It would thus be wrong to assume that robots are a substitute for personal assistance.

Robot *and* assistant

9.2 Conclusions

My conclusions can be summarized as follows:

- The concept of useworthiness and in-depth interviews about useworthiness with people with physical disabilities can be used for finding out why some people wish to have a robotic aid and why others do not wish to use a robot.
- Highly functional and versatile assistive devices afford better possibilities for studying people's needs and priorities.
- Reliability requirements are high in connection with user trials.
- Measuring the height, width, and thickness of a book, facilitates the use of a more reliable page-turning method.
- To enable a suction cup to separate the pages of a book in a reliable manner, the suction cup must be of the bellow-type, the air flow through the suction cup must be at least 20 l/min, a block must be located adjacent to the suction cup to bend the page when it is lifted, and the suction cup must lift the page close to the corner.
- At least two thirds of the time it takes to grasp an object using a directly controlled robot is spent making small adjustments to the position of the end-effector.
- The most difficult robot movements are the ones where it is necessary to change the orientation of the end-effector and the ones that require high precision.
- A test user must spend at least three half-days practicing in order to avoid the most common beginner's mistakes when using the Manus manipulator.
- In order to simplify robot use it is necessary to carry out detailed analyzes of robot movements relating to common tasks.
- High speed and acceleration within limited ranges of movement are necessary for carrying out tasks such as stirring sugar into a cup or shaking cake mix from a package.
- A Tool Center Point function and a function for preprogrammed 90° angles of the pitch and roll joints of the robot would make the Manus manipulator easier to use.
- To some extent, the most suitable location for a wheelchair-mounted robotic arm depends on whether the user is right-handed or left-handed.
- A robot can lead to increased independence without necessarily reducing the user's need for personal assistance.

9.3 Looking Ahead

Robotics is developing and improving. Even though it is not mainly centered on people with physical disabilities, the most important technical improvements to robots used in rehabilitation come from the general development of robotics. However, Rehabilitation Engineering research can contribute by carrying out in-depth analyzes of the individual useworthiness perspectives which are discussed in this thesis. This requires a decade of user research involving systematic trials at robotic centers where robots are available and can be, at least to some extent, adapted to the individual. In this connection, I would like to refer to a current analysis of the conditions of user research (Östlund, 1999) and the anthology "Users in Action" (Karlsson and Östlund, 1999).

Furthermore, it is necessary to carry out longitudinal studies: following individual users for a number of years. Although I am grateful that it has proved possible to put into context the results of several different projects and that this has revealed the outlines made visible in this thesis, future developments require a continuity and a systematic approach which have not been part of the external conditions of my work on this thesis.

References

- Apostolos, M. K. (1985). Exploring user acceptance of a robotic arm: an aesthetic orientation. *J Am Paraplegia Soc.*, 8(3), 51-54.
- Aydin, Y., & Nakajima, M. (1998). Database guided realistic grasping posture generation using inverse kinematics. *IEICE Transactions on information and Systems*, E81D (11), 1272-1280.
- Bach, J. R., Zeelenberg, A. P., & Winter, C. (1990). Wheelchair mounted robot manipulators. Long term use by patients with Duchenne muscular dystrophy. *Am J Phys Med Rehabil.*, 69(2), 55-59.
- Birch, G. E., & Cameron, W. (1990). User Acceptability in Robotic Assistive Devices. *Proc. International Conference on Rehabilitation Robotics (ICORR)*, 83-94.
- Birch, G. E., & Fengler, M. (1992). Experience with the Neil Squire Foundation/Regenesi robotic assistive appliance. *Proc. RESNA conference, Toronto, Canada*, 598-601.
- Birch, G. E. (1993). Development and methodology for the formal evaluation of the Neil Squire Foundation robotic-assistive appliance. *Robotica*, 11(6), 529-534.
- Birch, G. E., Fengler, M., & Gosine, R. G. (1993). Regenesi robotic appliance evaluation progress report. *Proc. RESNA conference, Las Vegas, Nevada, USA*, 501-503.
- Birch, G. E., Fengler, M., Gosine, R. G., Schroeder, K., Schroeder, M., & Johnson, D. L. (1996). An assessment methodology and its application to a robotic vocational assistive device. *Technol Disabil.*, 5(2), 151-165.
- Bolmsjö, G., & Efring, H. (1993). RAID, Robotic end-effector developments. *Proc. 1st TIDE Congr., Brussels, Belgium*, 108-112.
- Bolmsjö, G., Neveryd, H., & Efring, H. (1995). Robotics in rehabilitation. *IEEE Transactions on Rehabilitation Engineering* 3(1), 77-83. [Online]. URL: <http://www.certec.lth.se/doc/roboticsin/>
http://robocop.mtov.lth.se/Robotics/publications/abstracts/1995/bolmsjo95b_ieee.html
- Bush, G., Al-Temen, I., Hancock, J., Bishop, J., Slack, E. M., & Kurtz, I. (1994). Development of a Myoelectrically Controlled Wheelchair Mounted Object Manipulator for Quadriplegics. *Proc. International Conference on Rehabilitation Robotics (ICORR)*, 103-106.
- Bühler, C. (1998). Robotics for rehabilitation, a European (?) perspective. *Robotica*, 16(5), 487-490.

- Bühler, C., Hoelper, R., Hoyer, H., & Humann, W. (1995). Autonomous robot technology for advanced wheelchair and robotic aids for people with disabilities. *Robotics and Autonomous Systems*, 14(2-3), 213-222.
- Cammoun, R., Détriché, J.-M., & Lesigne, B. (1992). Optimization of the robotized system Master after its clinical evaluation. *Proc. International Conference on Rehabilitation Robotics (ICORR)*, (8 pages).
- Cammoun, R., Détriché, J.-M., Lauture, F., & Lesigne, B. (1993). Clinical evaluation of the 'MASTER' robot system and development of a new version. *Robotica*, 11(6), 535-539.
- Cammoun, R., Détriché, J.-M., Lauture, F., & Lesigne, B. (1994). The new Master man-machine interface. *Proc. International Conference on Rehabilitation Robotics (ICORR)*, 27-29.
- Casals, A., Villà, R., & Casals, D. (1993). A soft assistant arm for tetraplegics. *Proc. 1st TIDE Congr., Brussels*, 103-107.
- Cheatham, J. B., & Magee, K. (1997). Rehabilitation robotics and environmental control systems. *Phys Med Rehabil: State of the Art Reviews*, February, 11(1), 133-149.
- Dallaway, J. L., & Tollyfield, A. J. (1990). Task specific control of a robotic aid for disabled people. *Journal of Microcomputer Applications*, 13(4), 321-335.
- Dallaway, J. L., & Jackson, R. D. (1992). RAID – a vocational robotic workstation. *Proc. International Conference on Rehabilitation Robotics (ICORR)*, (11 pages).
- Dallaway, J. L., Mahoney, R. M., Jackson, R. D., & Gosine, R. G. (1993). An interactive robot control environment for rehabilitation applications. *Robotica*, 11(6), 541-551.
- Dallaway, J. L., & Jackson, R. D. (1993). The RAID workstation for office environments. *Proc. RESNA conference, Las Vegas, Nevada, USA*, 504-506.
- Dallaway, J. L., Jackson, R. D., & Timmers, P. H. A. (1995). Rehabilitation robotics in Europe. *IEEE Transactions on Rehabilitation Engineering*, 3(1), 35-45.
- Dallaway, J. L. (1996). Human-computer interaction within robotic workstations. *Proc. RESNA conference, Salt Lake City, Utah, USA*, 339-341.
- Danielsson, C., & Holmberg, L. (1994a). Evaluation of the RAID workstation. *Proc. RESNA conference, Nashville, Tennessee, USA*, 451-453.
- Danielsson, C., & Holmberg, L. (1994b). Evaluation of the RAID workstation. *Proc. International Conference on Rehabilitation Robotics (ICORR)*, 7-11.

- Dario, P., Guglielmelli, E., Allotta, B., & Carrozza, M. C. (1996). Robotics for medical applications. *IEEE Robotics and Automation Magazine*, September, 3(3), 44-56.
- Dario, P., Guglielmelli, E., Genovese, V., & Toro, M. (1996). Robot assistants: applications and evolution. *Robotics-and-Autonomous-Systems*, 18(1-2), 225-234.
- Department of Health, Education, and Welfare (1979). Belmont report: Ethical principles and guidelines for the protection of human subjects of research. Report of the National Commission for the Protection of Human Subjects of Biomedical and Behavioral Research [Online]. URL: <http://www.med.umich.edu/irbmed/ethics/belmont/BELMONTR.HTM>
<http://www.csu.edu.au/learning/ncgr/gpi/odyssey/privacy/Belmt.html>
- Détriché, J.-M., & Lesigne, B. (1989). The robotized system for helping the disabled persons. *Proc. IARP 2nd Workshop Med. Healthcare Robotics*, Newcastle, U.K. 19-41.
- Détriché, J.-M., & Lesigne, B. (1990). The integral system Master. *Proc. International Conference on Rehabilitation Robotics (ICORR)*, 161-175.
- Détriché, J.-M., Lesigne, B., & Bernard, T. (1991). Development of a workstation for handicapped people including the robotized system "Master". *Proc. International Conference on Rehabilitation Robotics (ICORR)*, 1-16.
- Détriché, J.-M., & Lesigne, B. (1991). Man machine interface and programming aspects of the robotized system "Master" for handicapped people. *Proc. International Conference on Rehabilitation Robotics (ICORR)*, 68-80.
- Didi, N., Grandjean, M., Mokhtari, M., & Roby-Brami, A. (1998). An assistive control system to the manipulation of the Manus arm robot. *Proc. RESNA conference*, Minneapolis, Minnesota, USA, 289-291.
- Didi, N., Mokhtari, M., & Roby-Brami, A. (1999). Preprogrammed gestures for robotic manipulators: An alternative to speed up task execution using Manus. *Proc. International Conference on Rehabilitation Robotics (ICORR)*, 92-98.
- Dijkers, M. P., DeBear, P. C., Erlandson, R. F., Kristy, K., Geer, D.M., & Nichols, A. (1991). Patient and staff acceptance of robotic technology in occupational therapy: a pilot study. *J Rehabil Res Dev.*, Spring, 28(2), 33-44.
- Eason K. D. (1984) Towards the experimental study of usability, *Behaviour and Information Technology*, 3(2), 133-143.

Eftring, H. (1990). Förbättrade CAD/CAM-system ger ökad produktflexibilitet i robotbetjänade fleroperationsmaskiner. Licentiatavhandling (Lic. Eng. Thesis), Inst. för Tillverkningsystem, KTH. TRITA-LVE 5202. ISSN 0280-2074. (In Swedish).

Eftring, H. (1990). The development of CAD/CAM for fast adaptation of FMS to just-in-time production. *CIRP Manufacturing Systems*, 19(4), 283-291.

Eftring, H., & Bolmsjö, G. (1993). RAID – a robotic workstation for the disabled. Proc. of the European Conference on the Advancement of Rehabilitation Technology (ECART), Stockholm, Sweden, (3 pages) 24.3. [Online]. URL: <http://www.certec.lth.se/doc/raida/>

Eftring, H., & Neveryd, H. (1993). Rehabilitation Robotics at CERTEC. Proc. 2nd Nordic Workshop on Rehabilitation Robotics.

Eftring, H. (1994a). Robot control methods and results from user trials on the RAID workstation. Proc. International Conference on Rehabilitation Robotics (ICORR), 97-101. [Online]. URL: <http://www.certec.lth.se/doc/robotcontrol/>

Eftring, H. (1994b). Robot control methods using the RAID workstation. Proc. International Conference on Computers for Handicapped Persons (ICCHP), 120-128.

Eftring, H., & Boschian, K. (1999). Technical Results from Manus User Trials. Proc. International Conference on Rehabilitation Robotics (ICORR), 136-141. [Online]. URL: <http://icorr99.stanford.edu/attendees/papers/eftring.html>

Engelhardt, K. G. (1986). Current status and future prospects for robotic technology in health care delivery. *Cent Nerv Syst Trauma*, Winter, 3(1), 111-126.

Engelhardt, K. G. (1989). An overview of health and human service robotics. *Robotics and Autonomous Systems*, 5(3), 205-226.

Engelhardt, K. G., & Goughler, D.H. (1997). Robotic applications in meal preparation assistance for older adults. *Industrial Robot*, 24(3), 239-245.

Fee, J. W. (1991). Rehabilitation robotics for individuals with disabilities. *J Vocat Rehabil*, April, 1(2), 65-69.

Finlay, P. A., Detriche, J-M., Bolmsjö, G., Jones, T., & Jackson, R. D. (1992). Interactive robotics in a CAD workstation. Proc. RESNA conference, Toronto, Canada, 103-104.

Forsman, B. (1996). Forskningsfusk och vetenskaplig oredlighet, Forskarnas ansvar och samhällets insyn (Research Fraud and Scientific Dishonesty). Department of Medical Ethics, Lund University. Lund, Sweden. ISBN 91-973056-0-X. ISSN 1402-1862. (In Swedish).

Fält, A., & Jönsson, B. (1999). Vad är rätt? Juridiska och etiska frågor i Certecs vardag (What is right?). Internal Report Certec, LTH, No. 1:1999. Lund, Sweden. [Online]. URL:

<http://www.certec.lth.se/dok/vadarratt/>

<http://www.certec.lth.se/doc/whatisright/>

Gelin, R., Coulon-Lauture, F., Lesigne, B., Le Blanc, J.-M., & Busnel, M. (1999). AFMASTER: an industrial rehabilitation workstation. Proc. International Conference on Rehabilitation Robotics (ICORR), 149-155.

General Assembly of the United Nations. (1948). Universal Declaration of Human Rights. Adopted and proclaimed by General Assembly resolution 217 A (III) of 10 December 1948.

[Online]. URL:

<http://www.un.org/Overview/rights.html>

http://www.handikappombudsmannen.se/Fn/Original_ver/orgver.html

Glass, K., & Hall, K. (1987). Occupational therapists' views about the use of robotic aids for people with disabilities. *Am J Occup Ther.*, Nov., 41(11), 745-747.

Gosine, R. G., Harwin, W. S., Furby, L. J., & Jackson, R. D. (1989). An intelligent end-effector for a rehabilitation robot. *J Med Eng Technol.*, 13(1-2), 37-43.

Greenhill, S. (1993). The digit Muscle, *Ind. Robot*, 20(5), 29-30.

Hagan, K., Hagan, S., Hillman, M., & Jepson, J. (1997). Design of a wheelchair mounted robot. Proc. International Conference on Rehabilitation Robotics (ICORR), 27-30.

Hammel, J., Hall, K., Lees, D., Leifer, L., Van der Loos, M., Perkas, I., & Crigler, R. (1989). Clinical evaluation of a desktop robotic assistant. *J Rehabil Res Dev.*, 26(3), 1-16.

Hammel, J. M., & Van der Loos, H. F. M. (1991). The assessment and prescription of robotics technology for individuals with severe physical disabilities. Proc. International Conference on Rehabilitation Robotics (ICORR), 81-92.

Hammel, J. M., Van der Loos, H. F. M., & Perkas, I. (1992). Evaluation of a vocational robot with a quadriplegic employee. *Arch Phys Med Rehabil*, 73(7), 683-693.

Hammel, J. M. (1995). The role of assessment and evaluation in rehabilitation robotics research and development: moving from concept to clinic to context. *IEEE Transactions on Rehabilitation Engineering*, 3(1), 56-61.

Harwin, W. S., Ginige, A., & Jackson, R. D. (1988). A robot workstation for use in education of the physically handicapped. *IEEE Transactions on Biomedical Engineering*, 35(2), 127-131.

Harwin, W. S., Rahman, T., & Foulds, R. A. (1995). A review of design issues in rehabilitation robotics with reference to North American research. *IEEE Transactions on Rehabilitation Engineering*, 3(1), 3-13.

Harwin, W. S., Gosine, R. G., Kazi, Z., Lees, D. S., & Dallaway, J. L. (1997). A comparison of rehabilitation robotics languages and software. *Robotica*, 15(2), 133-151.

Hegarty, J. (1991). Rehabilitation robotics: The user's perspective. Proc. 2nd Cambridge Workshop on Rehabilitation Robotics, Cambridge, U.K.

Hegarty, J. R., & Topping, M. J. (1991). "Handy 1" – A low-cost robotic aid to eating. Proc. International Conference on Rehabilitation Robotics (ICORR), 17-25.

Hegarty, J. R., & Pinnington, L. L. (1992). Preliminary studies on the acquisition of eating skills whilst using a robotic aid. Proc. International Conference on Rehabilitation Robotics (ICORR), (7 pages).

Hennequin, J., & Hennequin, Y. (1991). Inventaid, wheelchair mounted manipulator. Proc. 2nd Cambridge Workshop on Rehabilitation Robotics, Cambridge, U.K.

Hennequin, J. (1992). InventAid: Technology for the disadvantaged. Proc. RESNA conference, Toronto, Canada, 588.

Hillman, M. R. (1987). A feasibility study of a robot manipulator for the disabled. *J Med Eng Technol.*, 11(4), 160-165.

Hillman, M. R., Pullin, G. M., Gammie, A. R., Stammers, C. W., & Orpwood, R. D. (1990). Development of a robot arm and workstation for the disabled. *J Biomed Eng.*, 12(3), 199-204.

Hillman, M. R., Pullin, G. M., Gammie, A. R., Stammers, C. W., & Orpwood, R. D. (1991a). Clinical experience in rehabilitation robotics. *J Biomed Eng.*, 13(3), 239-243.

Hillman, M., Pullin, G., Gammie, A., Orpwood, R., & Stammers, C. (1991b). Evolutionary design: The role of clinical trials in the development of a robotic workstation. Proc. International Conference on Rehabilitation Robotics (ICORR), 93-108.

Hillman, M. (1992). Rehabilitation robotics. *Crit Rev Phys Rehabil Med.*, 4(1-2), 79-103.

Hillman, M., & Jepson, J. (1992). Evaluation of a robotic workstation for the disabled. *J Biomed Eng.*, May, 14(3), 187-192.

Hillman, M. R., Gammie, A. R., & Orpwood, R. D. (1992). Design of a robotic manipulator for a workstation or wheelchair mounted application. Proc. International Conference on Rehabilitation Robotics (ICORR), (6 pages).

Hillman, M., & Gammie, A. (1994). The Bath Institute of Medical Engineering assistive robot. Proc. International Conference on Rehabilitation Robotics (ICORR), 211-212.

Hillman, M., & Jepson, J. (1997). Evaluation of a trolley mounted robot – a case study. Proc. International Conference on Rehabilitation Robotics (ICORR), 95-98.

Hillman, M., Hagan, K., Hagan, S., Jepson, J., & Orpwood, R. (1999). A wheelchair mounted assistive robot. Proc. International Conference on Rehabilitation Robotics (ICORR), 86-91.

Hogan, N. (1998) A robot in the living room? Telemedicine Today, 6(4), 29-30.

Humanistisk-Samhällsvetenskapliga Forskningsrådet (Council for Research in the Humanities and Social Sciences) (1990).

Forskningsetiska principer i humanistisk-samhällsvetenskaplig forskning (Research ethics guidelines) (In Swedish). [Online].

URL:

http://www.hsfr.se/index_sidor/sokabidr_etikregler.htm

ISO 9241 (1997). ISO DIS 9241 Ergonomics requirements for office work with visual display terminals (VDTs), Part 11 Guidance on usability [Online]. URL:

<http://www.stud.fernuni-hagen.de/q4428161/health/iso9241.html>

<http://info.lut.ac.uk/research/husat/inuse/usabilitystandards.html>

Jackson, R. D. (1993). Robotics and its roll in helping disabled people. Engineering science and education journal, 2(6), 267-272.

Jones, T. (1999). RAID- toward greater independence in the office & home environment. Proc. International Conference on Rehabilitation Robotics (ICORR), 201-206.

Jönsson, B. (1990). (Re)habiliteringsteknik och forskningsbarhet. Internal Report Certec, LTH, No. 5:1990. Lund, Sweden. ISSN 1101-9956. (In Swedish).

Jönsson, B., Magnusson, C., & Efring, H. (1995). Capturing better data. UserTalk, Autumn, Issue 6, 4-5. [Online]. URL:

<http://www.certec.lth.se/doc/capturingbetter/>

Jönsson, B., Magnusson, C., Efring, H., & Svensk, A. (1995). (Re)habiliteringsteknisk forskning. Socialmedicinsk Tidskrift, 72(6-7), 224-230. (In Swedish). [Online]. URL:

<http://www.certec.lth.se/dok/rehabforskning/>

Jönsson, B. (1997). Certec's Core. Internal Report Certec, LTH. Lund, Sweden. [Online]. URL:

<http://www.certec.lth.se/doc/certecscore/>

Jönsson, B., Philipson, L., & Svensk, A. (1998). What Isaac taught us. Trydells Tryckeri, Laholm, Sweden. ISSN 1101-9956. [Online]. URL:

<http://www.certec.lth.se/doc/whatIsaac/>

Jönsson, B., & Anderberg, P. (1999). (Re)habiliteringsteknologi och design – dess teorier och metoder. Internal Report Certec, LTH, No. 2:1999. Lund, Sweden. ISRN CERTEC-IR--99/2--SE. ISSN 1101-9956. (In Swedish). [Online]. URL:

<http://www.certec.lth.se/dok/rehabiliteringsteknologi/>

Karlsson, M.-A., & Östlund, B. (1999). *Users in Action, Stories of Users and Telematics in Everyday Life*. Sweden.

Kassler, M. (1993). Robotics for health care: a review of the literature. *Robotica*, 11(6), 495-516.

Kazi, Z., Chen, S., Beitler, M., Chester, D., & Foulds, R. (1996). Multimodally controlled intelligent telerobot for people with disabilities. *Proceedings of the SPIE, The International Society for Optical Engineering*, 2901, 114-125.

Kazi, Z., & Foulds, R. (1998). Knowledge driven planning and multimodal control of a telerobot. *Robotica*, 16(5), 509-516.

Kerrigan, A. J. (1997). The psychosocial impact of rehabilitation technology. *Phys Med Rehabil: State of the Art Reviews*, February, 11(1), 239-252.

Kwee, H. H. (1986). *Spartacus and Manus: Telethesis developments in France and in the Netherlands*. In R. Foulds (Ed.), *Interactive robotic aids – One option for independent living: An international perspective*, Monograph 37 (pp. 7-17). New York, World Rehabilitation Fund.

Kwee, H. H., Duimel, J. J., Smits, J. J., Tuinhof de Moed, A. A., van Woerden, J. A., van der Kolk, L. W., & Rosier, J. C. (1989). The Manus wheelchair-borne manipulator: System review and first results. *Proc. Second Workshop on Medical and Healthcare Robotics*. Newcastle Upon Tyne, UK, 385-396.

Kwee, H. H., Thönnissen, M. M. M., Cremers, J. J., Duimel, J. J., & Westgeest, R. (1992). Configuring the Manus system. *Proc. RESNA conference*, Toronto, Canada, 584-587.

Kwee, H. H. (1995). Rehabilitation robotics – softening the hardware. *IEEE Engineering in Medicine and Biology Magazine*, 14(3), 330-335.

Kwee, H. H. (1997). Integrated control of Manus manipulator and wheelchair. *Proc. International Conference on Rehabilitation Robotics (ICORR)*, 91-94.

Kwee, H. H. (1998). Integrated control of MANUS manipulator and wheelchair enhanced by environmental docking. *Robotica*, 16(5), 491-498.

Kwee, H. H., Quaedackers, J., van de Bool, E., Theeuwen, L., & Speth, L. (1999). POCUS project: Adapting the control of the Manus manipulator for persons with cerebral palsy. *Proc. International Conference on Rehabilitation Robotics (ICORR)*, 106-114.

Lancioni, G., Bellini, D., & Oliva, D. (1993). Brief report: building choice opportunities within a robot-assisted occupational program: a case study. *Behav Residen Treat.*, July 8(3), 219-226.

Lancioni, G. E., Oliva, D., & Signorino, M. (1994). Promoting ambulation and object manipulation in persons with multiple handicaps through the use of a robot. *Percept Mot Skills*, Oct., 79(2), 843-848.

Law, M., Baptiste S., Carswell A., McColl M.A., Polatajko H., & Pollock N. (1994). *Canadian Occupational Performance Measure (COPM)*, second edition. Published by the Canadian Association of Occupational Therapists, Toronto. ISBN 1-895437-10-5.

Lees, D. S., & Leifer, L. J. (1994). Experimental evaluation of a graphical programming environment for service robots. *Proc. International Conference on Rehabilitation Robotics (ICORR)*, 19-23.

Lees, D., & Lepage, P. (1994). Will robots ever replace attendants? Exploring the current capabilities and future potential of robots in education and rehabilitation. *Int J Rehabil Res Dec.*, 17(4), 285-304.

Leifer, L., Toye, G., & Van der Loos, M. (1996). Tele service robot: integrating the socio-technical framework of human service through the InterNet World Wide Web. *Robotics and Autonomous Systems*, 18(1-2), 117-126.

Levine, S. P., Bell, D. A., & Koren, Y. (1994). NavChair: An example of a shared-control system for assistive technologies. *Proc. Int. Conf. Comput. for Handicapped Persons, Vienna, Austria*. 136-143.

Lindgaard, G. (1994). *Usability testing and system evaluation, A guide for designing useful computer systems*. Chapman & Hall, UK. Paperback ISBN 0-412-46100-5.

Lindström, M. (1993). *Intelligent control of a mobile robot base*, Master's thesis, Dept. of Production and Materials Eng., Lund University, Lund, Sweden. (In Swedish).

Löwgren, J. (1993). *Human-Computer Interaction: What every system developer should know*. Studentlitteratur, Sweden. ISBN 91-44-39651-1.

Mahoney, R. M. (1997). *Robotic products for rehabilitation: Status and strategy*, Proceedings of the International Conference on Rehabilitation Robotics (ICORR), 12-17.

Mattie, J., & Hannah, R. (1994). Evaluation of the Inventaid Manipulator Arm for Youth with Muscular Dystrophy. *Proc. International Conference on Rehabilitation Robotics (ICORR)*, 13-17.

McEachern, W. A., Dallaway, J. L., & Jackson, R. D. (1995). Sensor-based modification of manipulator trajectories for applications in rehabilitation robotics. *Transactions of the Institute of Measurement and Control*, 17(5), 272-280.

McGee, D. (1989). Robots in service to humans. *Robotics World*, 7(3), 28-31.

McLean, V. P. (1988). Using robots in a group with the neuropsychologically impaired: achieving a sense of control over the environment. *Occup Ther Ment Health*, 8(3), 155-164.

Medicinska Forskningsrådet (Swedish Medical Research Council) (1996). Riktlinjer för etisk värdering av medicinsk humanforskning, Forskningsetisk policy och organisation i Sverige (Policy paper on research ethics). ISBN 91-85546-99-2. ISSN 1401-288X. (In Swedish).

Milner, M., Naumann, S., King, A., & Verburg, G. (1992). Evaluation of Manus manipulator arm in ADL, vocational and school settings. Final report to National Health Research and Development Program, Project # 6606-4198-59, and Rick Hansen Man-in-Motion Legacy Fund, Project # 91-04, Toronto, September.

Mokhtari, M., Roby-Brami, A., & Laffont, I. (1997). A method for quantitative user evaluation in case of assistive robot manipulation. Proc. RESNA conference, Pittsburg, Pennsylvania, USA, 420-422.

Mokhtari, M., Didi, N., & Roby-Brami, A. (1998). Quantitative Evaluation of Human-Machine Interaction when using an arm robot. Proc. RESNA conference, Minneapolis, Minnesota, USA, 289-291.

Morvan, J. S., Guichard, J. P., & Torossian, V. (1997). Technical aids for the physically handicapped: a psychological study of the Master robot. *Int J Rehabil Res*, Jun., 20(2), 193-197.

Napper, S. A., & Seaman, R. L. (1989). Applications of robots in rehabilitation. *Robotics and Autonomous Systems*, 5(3), 227-239.

Neveryd, H. (1991). Christer Evaldssons robotiserade arbetsplats. Certec Report No. 1, 1991. Certec, Lund University, Sweden. ISSN 1101-9956. (In Swedish).

Neveryd, H., & Bolmsjö, G. (1993). Mobile robot system for disabled. Proc. of the Second European Conference on the Advancement of Rehabilitation Technology (ECART), Stockholm, Sweden, (3 pages) 24.1.

Neveryd, H., & Bolmsjö, G. (1994). Walky, a mobile robot system for the disabled. Proc. International Conference on Rehabilitation Robotics (ICORR), 137-141.

Neveryd, H. (1998). Ultraljudsnavigerande mobil robot för rörelsehindrade personer. Licentiatavhandling (Lic. Eng. Thesis), Certec, LTH. ISRN CERTEC-LR--98/1--SE. ISSN 1101-9956. (In Swedish).

Nielsen, J. (1994). Usability Engineering. AP Professional, Academic Press. ISBN 0-12-518406-9.

- Nikoleris, G., Brink, K., Olsson, M., & Bolmsjö, G. (1993). Simplified programming of robots-Sport.Proc. Robotics Workshop, Linköping, Sweden, B2.
- Nuremberg Code (1949). Trials of War Criminals before the Nuremberg Military Tribunals under Control Council Law No.10. vol. 2, 181-182. U.S. Government Printing Office. Washington, D.C., U.S. [Online]. URL: <http://www.csu.edu.au/learning/ncgr/gpi/odyssey/privacy/NurCode.html>
- O'Connel, S., & Topping, M. (1999). A User's Perspective on the Handy 1 System. Proc. International Conference on Rehabilitation Robotics (ICORR), 115-121.
- Peters, G., & de Moel, F. (1996). Evaluation of Manus robot arm users in the context of the General Invalidity Act. GMD Evaluation Report, Amsterdam, the Netherlands, September.
- Pinnington, L. L., & Hegarty, J. R. (1994). Preliminary findings on the everyday use of a robotic aid to eating. *Clin Rehabil*, 8(3), 258-265.
- Platts, R. G., & Fraser, M. H. (1993). Assistive technology in the rehabilitation of patients with high spinal cord lesions. *Paraplegia*, 31(5), 280-287.
- Prior, S. D. (1990). An electric wheelchair mounted robotic arm – a survey of potential users. *J Med Eng Technol.*, 14(4), 143-154.
- Pullin, G., & Gammie, A. (1991). Current capabilities of rehabilitation robots. *Journal of Biomedical Engineering*, 13(3), 215-216.
- Rahman, T., & Harwin, W. S. (1993). Bilateral control in teleoperation of a rehabilitation robot. *Proceedings of the SPIE, The International Society for Optical Engineering*, 1833, 20-27.
- Rahman, T., Stroud, S., Ramanathan, R., Alexander, M., Seliktar, R., & Harwin, W. (1996). Task priorities and design for an arm orthosis. *Technology and Disability* 5(2), 197-203.
- Regalbuto, M. A., Krouskop, T. A., & Cheatham, J. B. (1992). Toward a practical mobile robotic aid system for people with severe physical disabilities. *J Rehabil Res Dev.*, 29(1), 19-26.
- Seamone, W., & Schmeisser, G. J. (1985). Early clinical evaluation of a robot arm/worktable system for spinal cord injured persons. *Rehabil Res Dev.*, 22(1), 38-57.
- Schön, D. (1983). *The Reflective Practitioner*. Hampshire: Ashgate.
- Sheredos, S. J., Taylor, B., Cobb, C. B., & Dann, E. E. (1995). The Helping Hand electro-mechanical arm. Proc. RESNA conference, Vancouver, BC, Canada, 493-495.

- Sheredos, S. J., Taylor, B., Cobb, C. B., & Dann, E. E. (1996). Preliminary evaluation of the helping hand electro-mechanical arm. *Technol Disabil*, 5(2), 229-232.
- Sheredos, S. J., & Taylor, B. (1997). Clinical evaluation of the Helping Hand electro-mechanical arm. *Proc. RESNA conference*, Pittsburg, Pennsylvania, USA, 378-380.
- Shoupu, C., Rahman, T., Foulds, R., Heredia, E., & Harwin, W. S. (1998). Virtual headstick for people with spinal cord injuries. *Robotica*, 16(5), 499-507.
- Shramowiat, M., Bach, J. R., & Bocobo, C. (1989). Functional enhancement of patients with Duchenne muscular dystrophy with the use of robot-manipulator trainer arms. *J Neurol Rehabil*, 3(3), 129-132.
- Smith, J., & Topping, M. (1997). Study to determine the main factors leading to the overall success of the handy 1 robotic system. *Proc. International Conference on Rehabilitation Robotics (ICORR)*, 147-150.
- SOU 1999:4. (1999). God sed i forskningen (Good research practice). (In Swedish). [Online]. URL: <http://utbildning.regeringen.se/propositionermm/sou/>
- Stanger, C. A., Anglin, C., Harwin, W. S., & Romilly, D. P. (1994). Devices for assisting manipulation: a summary of user task priorities. *IEEE Transactions on Rehabilitation Engineering*, 2(4), 256-265.
- Stanger, C. A., & Cawley, M. F. (1996). Demographics of rehabilitation robotics users. *Technology and Disability* 5(2), 125-137.
- Stassen, H. G., & Smets, G. J. F. (1997). Telemanipulation and telepresence. *Control Engineering Practice*, 5(3), 363-374.
- Stuyt, H. J. A. (1997). Manus in Europe. *Proc. International Conference on Rehabilitation Robotics (ICORR)*, 111-115.
- Taylor, B., Cupo, M. E., & Sheredos, S. J. (1993). Workstation robotics: a pilot study of a Desktop Vocational Assistant Robot. *Am J Occup Ther.*, 47(11), 1009-1013.
- TIDE (1993)., TIDE 1993-1994 workplan, Commission of the European Communities.
- Topping, M. (1993). Early experience in the use of the 'Handy 1' robotic aid to eating. *Robotica*, 11(6), 525-527.
- Topping, M., Heck, H., & Bolmsjö, G. (1997). An overview of the BIOMED 2 RAIL (Robotic Aid to Independent Living) project. *Proc. International Conference on Rehabilitation Robotics (ICORR)*, 23-26.
- Topping, M., & Smith, J. (1998). The development of Handy 1, a rehabilitation robotic system to assist the severely disabled. *Industrial Robot*, 25(5), 316-320.

- Topping, M. J., & Smith, J. K. (1999). The development of handy 1. A robotic system to assist the severely disabled. *Technol Disabil.*, 10(2), 95-105.
- Van der Loos, H. F. M., & Hammel, J. M. (1990). Designing rehabilitation robots as household and office equipment. *Proc. International Conference on Rehabilitation Robotics (ICORR)*, 121-136.
- Van der Loos, H. F. M., Hammel, J., Lees, D., Chang, D., Perakash, E., & Leifer, L. (1990). A voice-controlled robot system as a quadriplegic programmer's assistant. *Proc. RESNA conference, Washington, D.C., USA*, 129-130.
- Van der Loos, H. F. M., Hammel, J., & Leifer, L. J. (1994). DeVAR transfer from R&D to vocational and educational settings. *Proc. International Conference on Rehabilitation Robotics (ICORR)*, 151-155.
- Van der Loos, H. F. M., & Hammel, J. (1994). Use of a rehabilitation robot in a classroom setting. *Proc. RESNA conference, Nashville, Tennessee, USA*, 442-444.
- Van der Loos, H. F. M. (1995). VA/Stanford rehabilitation robotics research and development program: lessons learned in the application of robotics technology to the field of rehabilitation. *IEEE Transactions on Rehabilitation Engineering*, 3(1), 46-55.
- Verburg, G., Milner, M., Naumann, S., Bishop, J., & Sas, O. (1992). An evaluation of the Manus wheelchair-mounted manipulator. *Proc. RESNA conference, Toronto, Canada*, 602-604.
- Verburg, G., Naumann, S., King, A., & Bennet, W. (1993). Development of integrated control system and mounting adaptation for Manus manipulator arm. Final report to Rick Hansen Man in Motion Legacy Fund, Toronto, January.
- Verburg, G., Kwee, H., Wisaksana, A., Cheetham, A. & van Woerden, J. (1996). Manus: The evolution of an assistive technology. *Technology and Disability* 5(2), 217-228.
- Wada, M., & Mikami, S. (1997). Toward third arm robots humanoid robotic arm for cooperation between humans and robots. *Advanced Robotics*, 11(6), 559-566.
- Whittaker, M. (1992). Handy 1 robotic aid to eating: A study in social impact. *Proc. RESNA conference, Toronto, Canada*, 589-594.
- Whittaker, W. L., Dowling, K., Osborn, J., & Singh, S. (1990). Robots for unstructured environments. *Unmanned Systems*, 8(1), 21-31.
- Wilkes, D. M., Alford, A., Pack, R. T., Rogers, T., & Peters, R. A. II., & Kawamura, K. (1998). Toward socially intelligent service robots. *Applied Artificial Intelligence*, 12(7-8), 729-766.

World Medical Association. (1989). Declaration of Helsinki.
[Online]. URL:
<http://www.csu.edu.au/learning/ncgr/gpi/odyssey/privacy/HelDec.html>

Øderud, T., & Bastiansen, J. E. (1992). Integrating a Manus manipulator and an electric wheelchair. Practical experiences. Proc. RESNA conference, Toronto, Canada, 595-597.

Øderud, T., Bastiansen, J. E., & Tyvand, S. (1993). Experiences with the Manus wheelchair mounted manipulator. Proc. of the European Conference on the Advancement of Rehabilitation Technology (ECART), Stockholm, Sweden, (3 pages) 29.1.

Östlund, B. (1999). The state of the art in user research, Förslag till en inventering skriven på uppdrag av Kommunikationsforskningsberedningen. Tema Teknik och Social Förändring, Linköping University, Sweden. (In Swedish).

Appendix A

Reliability of RAID1 Tasks

Test specification and results of books 5, 6 and of a pile of A4 paper sheets according to Section 4.6.2.

Test specification for books

Open the book 15 times at a fixed distance from the surface of the readerboard. The fixed distance should be at the beginning of the book. Document the page numbers, where the robot opens the book.

Close the book 5 times from the beginning of the book, 5 times from the middle of the book and 5 times from the end of the book.

Turn single pages at the beginning of the book in the following manner: Open the book manually 10 pages from the front cover of the book. Turn pages back until the front cover of the book, then 10 pages forward, 10 pages back and finally 10 pages forward.

Turn single pages in the middle of the book Open the book manually. Turn 10 pages forward, 10 pages back, 10 pages forward and finally 10 pages back.

Turn single pages at the end of the book: Open the book manually 10 pages from the back cover of the book. Turn pages forward until the back cover of the book, then 10 pages back, 10 pages forward and finally 10 pages back.

Turn multiple pages, approximately 50 at a time (50 pages correspond approximately to 5 mm): When the book is opened, turn pages forward until the back cover of the book, turn back until the front cover of the book, turn forward until the back cover of the book, and finally back until the front cover of the book. Document all page numbers as well as any failures, that may occur during the page turning.

Results of book 5

Open the book

Number of attempts: 15

The book opened at page numbers: 97, 97, 97, 97, 95, 95, 95, 95, 95, 95, 95, 95, 95. (Text on both sides of the pages. Therefore, there are only odd numbers in this test.)

Failures

- No failures: 4 times
- OK, but not smooth: 11 times
(The book finally opened at page 95, although the knife entered the book at pages 87, 89 and 91, but 4, 3 or 2 extra pages were turned.)

Close the book from the beginning of the book

Number of attempts: 15

Failures

- No failures: 15 times

Close the book from the middle of the book (from page 201)

Number of attempts: 5

Failures

- OK, but not smooth: 5 times
(The book almost turned over. The suction cup did not hold the book.)

Close the book from the end of the book (from page 393)

Number of attempts: 5

Failures

- OK, but not smooth: 5 times
The suction cup did not hold the book.

Turn single pages at the beginning of the book

Number of attempts: 1

Number of turns forward: 0

Number of turns back: 1

Failures

- OK, but not smooth: 5 times
("Movement impossible" after the suction cup has reached the page surface.)

Turn single pages in the middle of the book

Number of attempts: 1

Number of turns forward: 20

Number of turns back: 20

Failures

- No failures: 34 times (16 forward, 18 back)
- OK, but not smooth: 3 times (3 forward)
- No page was turned: 1 time (1 forward. The suction cup dropped the page.)
- Two or more pages were turned: 2 times (2 back. The clamp grasped two pages.)

Turn single pages at the end of the book

Number of attempts: 0

Turn multiple pages (approximately 50 at a time)

Number of attempts: 1

Number of turns forward: 8

Number of turns backwards: 1

Page numbers: 131, 213, 227, 319, 351, 367, 367, back cover, the book turned over.

Failures

- No failures: 7 times (7 forward)
- No page was turned: 1 time (1 forward. The pages were dropped.)
- The book turned over: 1 time (1 back. The suction cup did not hold the book.)

Results of book 6

Open the book

Number of attempts: 15

The book opened at page numbers: 43, 57, 45, 45, 57, 37, 39, 41, 49, 49, 49, 41, 41, 43, 47.

Failures

- No failures: 15 times

Close the book from the beginning of the book

Number of attempts: 15

Failures

- No failures: 15 times

Close the book from the middle of the book (from page 131)

Number of attempts: 5

Failures

- No failures: 5 times

Close the book from the end of the book (from page 251)

Number of attempts: 5

Failures

- The book turned over: 5 times
(The suction cup did not hold the book.)

Turn single pages at the beginning of the book

Number of attempts: 1

Number of turns forward: 20

Number of turns back: 20

Failures

- No failures: 30 times (18 forward, 12 back)
- Two or more pages were turned: 8 times (2 forward because of gripper approach, 6 back because of the page-retaining finger)
- The page-retaining finger folded a page: 2 times (2 back)

Turn single pages in the middle of the book

Number of attempts: 1

Number of turns forward: 20

Number of turns back: 20

Failures

- No failures: 38 times (18 forward, 20 back)
- Two or more pages were turned: 2 times (2 forward because of gripper approach)

Turn single pages at the end of the book

Number of attempts: 1

Number of turns forward: 20

Number of turns back: 20

Failures

- No failures: 18 times (18 back)
- OK, but not smooth: 2 times (2 forward)
- No page was turned: 3 (3 forward)
- Two or more pages were turned: 16 times (15 forward. No page was lifted, but all pages were turned, because of the page-retaining finger. 1 back. The suction cup lifted two pages.)
- The page was damaged: 1 time (1 back)

Turn multiple pages (approximately 50 at a time)

Number of attempts: 1

Number of turns forward: 13

Number of turns backwards: 13

Page numbers: 93, 127, 155, 213, back cover, 235, 235, 125, 87, 47, 25, front cover, 37, 111, 131, 153, 153, 187, 235, back cover, 197, 131, 87, 37, 11, front cover.

Failures

- No failures: 23 times (11 forward, 12 back)
- No page was turned: 2 times (1 forward. The knife dropped the pages. 1 back)
- The page-retaining finger folded a page: 1 time (1 forward. Five pages were turned.)

Test specification 1 for a pile of A4 paper sheets

Turn single pages in a pile of A4 paper sheets of 100 g/m² in the following manner:

- Move a pile of 10 paper sheets from bin number 1 to the readerboard
- Turn forward through the whole pile (10 pages),
- back 10 pages,
- forward 10 pages,
- back 10 pages,
- forward 10 pages and finally
- back 10 pages.
- Measure the width of the pile after each step. The width of one A4 paper sheet is 210 mm.
- Return the pile of paper sheets into bin number 1.
- Repeat the whole test procedure 5 times, starting from bin number 1.

Results

Number of attempts: 5

Number of turns forward: 90

Number of turns back: 90

Failures

- No failures: 152 times (64 forward, 88 back)
- Two or more pages were turned: 13 times (11 forward, 2 back because of the suction cup)
- The first page got stuck on the readerboard: 15 times (15 forward because of the hole in the readerboard)

<i>Step number</i>	<i>Test 1</i>	<i>Test 2</i>	<i>Test 3</i>	<i>Test 4</i>	<i>Test 5</i>
Initial width (mm)	212	214	215	214	217
Width after step 1	215	218	221	217	226
Width after step 2	224	225	223	220	233
Width after step 3	223	230	235	216	225
Width after step 4	228	220	219	223	221
Width after step 5	220	214	217	222	218
Width after step 6	224	232	223	221	232
Papers into bin?	No	No	No	No	No

Test specification 2 for a pile of A4 paper sheets

Turn single and multiple pages in a pile of A4 paper sheets of 80, 100 and 160 g/m² in the following manner:

- Move a pile of 10 paper sheets from bin number 1 to the readerboard.
- Turn to the last page (all pages at the same time)
- to the first page (all pages at the same time)
- one page forward
- to the last page
- one page backward
- to the first page
- two pages forward
- two pages backward
- Measure the width of the pile after step 0, 1, 2, 4, 6 and 8.
- Return the pile of paper sheets into bin number 1.
- Repeat the whole test procedure for paper sheets of 80, 100 and 160 g/m².

Results

Number of attempts: 1 per paper quality

Number of turns forward: 3

Number of turns back: 3

Number of turns to the last page: 2

Number of turns to the first page: 2

Failures (80 g/m²)

- No failures: 9 times (3 forward, 2 back, 2 last, 2 first)
- Two or more pages were turned: 1 time (1 back because of the suction cup)

Failures (100 g/m²)

- No failures: 8 times (2 forward, 2 back, 2 last, 2 first)
- Two or more pages were turned: 2 time (1 forward, 1 back because of the suction cup)

Failures (160 g/m²)

- No failures: 10 times (3 forward, 3 back, 2 last, 2 first)

<i>Step number</i>	<i>80 g/m²</i>	<i>100 g/m²</i>	<i>160 g/m²</i>
Initial width (mm)	212	211	217
Width after step 1	212	212	217
Width after step 2	213	215	234
Width after step 4	227	227	263
Width after step 6	249	231	262
Width after step 8	240	228	236
Papers into bin?	No	No	No

Appendix B

Reliability of RAID1A Tasks

Page-turning results of the book “Rehabilitation Technology” and of a pile of A4 paper sheets according to Section 4.6.4.

Results of the book “Rehabilitation Technology”

Open the book

Number of attempts: 6

Failures

- No failures: 4 times
- More pages turned by themselves: 2 times

Turn single pages forward

Number of attempts: 57

Failures

- No failures: 52 times
- More than one page was turned, because the suction cup did not separate pages: 5 times

Turn single pages back

Number of attempts: 56

Failures

- No failures: 51 times
- More pages turned by themselves: 5 times

Turn multiple pages forward

Number of attempts: 53

Failures

- No failures: 44 times
- More pages turned by themselves: 6 times
- The pages were folded when they were grasped, because the book was not held flat: 1 time
- Pages were folded, because the finger hit the next pages, which turned by themselves: 2 times

Turn multiple pages back

Number of attempts: 52

Failures

- No failures: 34 times
- More pages turned by themselves: 8 times
- Pages were folded, because the finger hit the next pages, which turned by themselves: 6 times
- The book moved during turning, because the suction cup did not hold the book: 3 times
- OK, but the pages were not grasped, because the book was not hold flat: 1 time

Results of a pile of A4 paper sheets

Paper type used:

- Stora Papyrus, Cyclus Copy 141.081 (RAID paper), weight 90 g/m²
- Stora Papyrus, Multi Laser 154.063 (429 189), weight 75 g/m²
- SCA, Wifsta Office Premium, 7391649750153, weight 80 g/m²

STORA PAPYRUS, CYCLUS Copy 141.081, "RAID paper"

Turn single pages forward

Number of attempts: 50

Failures

- No failures: 41 times
- More than one page was turned, because the suction cup did not separate pages: 1 time
- No sheet was turned, because the sheet was dropped immediately after grasping: 7 times
- More than one sheet was turned and one or more were dropped during turning: 1 time

Turn single pages back

Number of attempts: 50

Failures

- No failures: 42 times
- More than one page was turned, because the suction cup did not separate pages: 6 times
- More than one sheet was turned and one or more were dropped during turning: 2 times

Turn all pages forward

Number of attempts: 10, no failures

Turn all pages back

Number of attempts: 10, no failures

STORA PAPYRUS, Multi Laser 154.063 (429 189)

Turn single pages forward

Number of attempts: 12

Failures

- No failures: 5 times
- More than one page was turned, because the suction cup did not separate pages: 7 times

Turn single pages back

Number of attempts: 2

Failures

- No failures: 0 times
- More than one page was turned, because the suction cup did not separate pages: 2 times

SCA, Wifsta Office Premium, 7391649750153

Turn single pages forward

Number of attempts: 20

Failures

- No failures: 2 times
- More than one page was turned, because the suction cup did not separate pages: 10 times
- More than one sheet was turned and one or more were dropped during turning: 8 times

Turn single pages back

Number of attempts: 25

Failures

- No failures: 0 times
- More than one page was turned, because the suction cup did not separate pages: 24 times
- More than one sheet was turned and one or more were dropped during turning: 1 time

Turn all pages forward

Number of attempts: 5, no failures

Turn all pages back

Number of attempts: 5, no failures

Appendix C

Manus Arm Questionnaire

This questionnaire is referred to in Section 5.1.3.

Name: _____

Work/studies

- I work Number of hours per day: _____
 I am a student Number of hours per day: _____

Need for assistance

- Personal assistant Number of hours per day: _____
 Home help service Number of hours per day: _____
 Other daily assistance Number of hours per day: _____

How many hours per day, of your waking hours, do you spend on your own (with nobody nearby who can offer immediate assistance)? Number of hours per day: _____

Your thoughts about testing the Manus arm

Why did you want to try the Manus?

I think it is interesting to test new devices.

- I strongly agree I agree I disagree I strongly disagree

I am looking for devices that will increase my independence.

- I strongly agree I agree I disagree I strongly disagree

I wanted to find out if a robot would suit me.

- I strongly agree I agree I disagree I strongly disagree

I want to be able to inform other users about robotic aids.

- I strongly agree I agree I disagree I strongly disagree

Other: _____

Did testing the Manus meet your expectations with respect to

- the information provided before the testing began? Yes Somewhat No
- the implementation of the testing? Yes Somewhat No

Comments: _____

How can we improve? _____

What do you consider to be a suitable time period for testing the Manus arm?

Number of days: _____ Number of hours per day: _____

Comments: _____

Your thoughts after testing the Manus arm

(You may answer 'yes' without giving any examples but, naturally, we would be very grateful for any examples you may provide.)

Compare your expectations to the actual performance of the Manus.

Were you able to carry out tasks that you did not think you would be able to do before the testing began? Yes No

If yes, please specify _____

Did you experience anything special when testing the Manus? Yes No

If yes, please describe _____

Did the Manus give you any new ideas? Yes No

If yes, please describe your ideas _____

After testing the Manus, have you been in any situation that made you think: "The Manus arm could help me with this."?

Yes No

If yes, please specify _____

Are there any tasks currently performed by your personal assistants/relatives/friends that you would rather carry out with the aid of the Manus arm? Yes No

Why/why not? _____

Have you discussed the Manus arm with other people? Yes No

If yes, what were their reactions or comments? _____

When do you think is a good time to receive information about robotic aids?

- As soon as possible after the injury
- After 1-2 months
- Prior to being discharged
- A month or two after being discharged
- Other time, when? _____

How would you like to receive information about the Manus arm?

- Demonstrations by Manus users
- Demonstrations by medical/rehabilitation staff
- Verbally by medical/rehabilitation staff or users
- Video
- Information folder
- Other

Comments: _____

When is a good time to test a robotic aid?

- As soon as possible after the injury
- After 1-2 months
- Prior to being discharged
- A month or two after being discharged
- Other time, when? _____

Although no new testing is planned, would you like to test the Manus again in the future? Yes No

Why/why not? _____

If yes, in what environment?

- at home
- at the Department of Rehabilitation
- Other environment, please specify: _____

If yes, what activity or activities would you like to try? _____

Do you agree with the following comments provided by Manus testers?

The Manus arm enables me to do things when I want to, rather than having to wait for someone to help me.

- I strongly agree
- I agree
- I disagree
- I strongly disagree

If I had a Manus, I wouldn't have to plan my day as carefully as I do now.

- I strongly agree
- I agree
- I disagree
- I strongly disagree

If I had a Manus, I wouldn't need to bother someone else, for example to get me a binder.

- I strongly agree
- I agree
- I disagree
- I strongly disagree

It is important to me to be able to look at my personal documents in private.

- I strongly agree
- I agree
- I disagree
- I strongly disagree

I have adapted my day so that I get help when it is available, so I can't think of very many situations where the Manus would be useful to me.

- I strongly agree
- I agree
- I disagree
- I strongly disagree

The Manus arm would be a good complement to my environmental control unit, for instance for turning more lights on and off in my home.

- I strongly agree
- I agree
- I disagree
- I strongly disagree

The Manus arm has made me think more about planning my physical environment (e.g. where phones, door opening buttons, bookshelves, or computers should be located or how they should be designed).

- I strongly agree
- I agree
- I disagree
- I strongly disagree

If you agree, please provide examples: _____

Having the Manus arm would increase my sense of freedom.

- I strongly agree
- I agree
- I disagree
- I strongly disagree

Comments on any of the above statements: _____

Focus on the device

For whom do you think the Manus arm would be a useful assistive device? _____

Would you like to have a Manus, as it looks and works today?

Yes No

Why/why not? _____

If no, would you like to have a Manus if it was improved in some way?

Yes No

What improvements to the Manus arm would you like to see? _____

Is the Manus fast enough?

Too slow Just right Too fast

Comments: _____

Is the Manus strong enough?

Too weak Just right Too strong

Comments: _____

Is the Manus easy to use?

Easier than expected Very much as I expected

More difficult than I expected

Comments: _____

What did you find most difficult when using the Manus? Why? _____

If you had a Manus

If you had a Manus, what are the main situations in which you would use it? _____

If you had a Manus, how many hours per day do you think you would use it? Number of hours per day: _____

Would a Manus make you more independent in some way?

Yes Somewhat No

If yes, how? _____

Would you be able to carry out any new tasks if you had a Manus?

Yes No

If yes, please specify _____

Would you be able to participate in more recreational activities if you had a Manus?

Yes No

If yes, please specify _____

Would a Manus improve your quality of life?

Yes Somewhat No

Activities

The following activities have been carried out using the Manus arm at the Department of Rehabilitation or in the user's home. Please add to this list any activities you think we should suggest to future Manus test users. _____

Additional comments

Please write any comments you may have about things we have not asked. Or write any additional comments on your answers to this questionnaire. _____

Appendix D

Safety Considerations of Manus

These safety considerations are taken from Exact Dynamics bv, the manufacturer of Manus arms. This appendix is referred to in Section 8.3.1.

Safety Considerations

When designing Manus a few precautions were taken:

- The power supply has been maximized.
- There is an operating system with a feedback for controlling speed, gears and position. Due to this feedback the display shows a sign if something is wrong.
- To move Manus the concerning button of the keyboard has to be pushed continuously. Manus will stop moving when you let go of the button.
- There is a mechanical safety by means of the couplings.

Safe use of Manus requires a few things of the user. The user is also responsible for safe use of the Manus system. Exact Dynamics is not responsible for any damage or harm caused by unsafe use of Manus. When using Manus the following prescriptions have to be considered:

- Manus may not be used to put something in or on the body. An operation failure could lead to dangerous situations. The following list shows a few examples:
 - It is not allowed to smoke or to work with fire.
 - It is not allowed to give an injection.
 - Do not move food in the mouth, but position the food just in front of the mouth and eat by moving your head.
- Manus cannot be used for lifting and moving objects heavier than 2 kg.
- Manus may not be used to lift or move objects with hot substance.
- Manus has in every direction the same power (also in direction of the user).
- Do not handle sharp objects with Manus.
- It is not allowed to operate the wheelchair with Manus.
- Gripper remains closed when power shuts down.
- Pushing on more than one button, the Manus does not move.

Safe eating

Eating with cutlery can cause a dangerous situation. Please read the following tips carefully.

- To prevent that the spoon hits the plate, it is a good suggestion to bend the spoon. The distance between gripper and plate is larger now.
- It is often a problem to dish up, as food is spoiled or the plate will move. Special plates with rims and antiskid mats are available.
- As eating with Manus does not go very fast, the food will be cold. To prevent this special warmed up plates are available.
- Ladle out soup is often a problem, the best solution is to use a special cup with spout.
- Please note: never put the cutlery in your mouth!

Safe drinking

Lots of drinks are warm and can therefore be of danger if they get spilled over you. To decrease the risks, the Manus (with cup) has to approach you from the side. When the cup is just in front of your mouth, Manus can make a drinking movement (with the drinking menu).

This thesis deals with robotics and the new possibilities it offers people with physical disabilities. I focus on the user and the use of the technology and, in particular, on what makes robotic aids worth using – useworthiness as distinguished from usability.

Experience of the useworthiness of robots was first obtained through the development of page-turning end-effectors for the RAID workstation. The principles of separating pages and the page-turning movements are analyzed and described in this thesis. User experience of the wheelchair-mounted Manus manipulator shows that robotic arms must meet technical requirements in terms of acceleration, speed, and pattern of movement.

The thesis demonstrates that user trials with robots as assistive devices can result in new knowledge about both the use of the technology itself and the personal characteristics – needs, abilities, wishes, and dreams – of the user.

The thesis is also available on the Internet, where you will find video sequences of the page turning movements of the RAID workstation:
<http://www.certec.lth.se/doc/useworthiness/>



Department of
Design Sciences
Lund University



Certec, LTH
Box 118
SE-221 00 Lund
Sweden



John Ericssons väg 1,
SE-223 63 Lund
Sweden



+46 46 222 46 95



+46 46 222 44 31



certec@certec.lth.se



<http://www.certec.lth.se>

Certec is a research and teaching unit in the Department of Design Sciences at Lund University. Moreover, a great deal of our work involves making information bearing Certec's stamp available to the public, primarily via the Internet.

We have about 20 staff members and an annual budget of about 10 million kronor. We receive the major part of our basic grants from Region Skåne and Lund University. Project funding is provided by the KK Foundation and several other contributors. A special Certec Fund is being set up.

DOCTORAL DISSERTATION

ISBN 91-628-3711-7

AUGUST 1999

Håkan Efring

**The Useworthiness of Robots for
People with Physical Disabilities**