



# LUND UNIVERSITY

## The development of electrical imaging techniques

Dahlin, Torleif

*Published in:*  
Computers and Geosciences

*DOI:*  
[10.1016/S0098-3004\(00\)00160-6](https://doi.org/10.1016/S0098-3004(00)00160-6)

2001

[Link to publication](#)

*Citation for published version (APA):*  
Dahlin, T. (2001). The development of electrical imaging techniques. *Computers and Geosciences*, 27(9), 1019-1029. [https://doi.org/10.1016/S0098-3004\(00\)00160-6](https://doi.org/10.1016/S0098-3004(00)00160-6)

*Total number of authors:*  
1

### General rights

Unless other specific re-use rights are stated the following general rights apply:  
Copyright and moral rights for the publications made accessible in the public portal are retained by the authors and/or other copyright owners and it is a condition of accessing publications that users recognise and abide by the legal requirements associated with these rights.

- Users may download and print one copy of any publication from the public portal for the purpose of private study or research.
- You may not further distribute the material or use it for any profit-making activity or commercial gain
- You may freely distribute the URL identifying the publication in the public portal

Read more about Creative commons licenses: <https://creativecommons.org/licenses/>

### Take down policy

If you believe that this document breaches copyright please contact us providing details, and we will remove access to the work immediately and investigate your claim.

LUND UNIVERSITY

PO Box 117  
221 00 Lund  
+46 46-222 00 00



# The development of DC resistivity imaging techniques

Torleif Dahlin

*Department of Geotechnology, Lund University, Box 118, S-221 00 Lund, Sweden*

Received 16 July 1999; received in revised form 17 January 2000; accepted 21 January 2000

---

## Abstract

The development of direct current resistivity imaging techniques has been rapid in the last years. This applies to data acquisition as well as inverse modelling techniques, and has led to a greatly expanded practical applicability of the method. Resistivity imaging is now becoming widely used in environmental and engineering applications where increased knowledge about the subsurface is sought. The ongoing development can be expected to continue. © 2001 Elsevier Science Ltd. All rights reserved.

*Keywords:* Resistivity; Imaging; Galvanic; Data acquisition; Inverse modelling

---

## 1. Introduction

Over the past few decades, growing populations have increased the pressure on natural resources, raising demands for water supply, housing and infrastructure. This pressure can be expected to rise, and combined with environmental stress caused by pollution, there is a growing need for detailed geological studies connected to environmental protection and infrastructure development. Geophysical methods can play an important role in these studies, where direct current (DC) resistivity imaging is one of the methods of primary interest.

This paper includes a short introduction to DC resistivity imaging and attempts to provide a brief summary of the past and ongoing development of the method, without any ambition of writing the history of the method. It includes short descriptions of the procedures used for data acquisition, the methods used to process data and how resistivity images are constructed and interpreted. A few field examples are presented to illustrate the applicability of the method.

## 2. The resistivity method

The work on introducing current into the ground for prospecting purposes started around a century ago. Early work was done qualitatively by locating conductive anomalies by moving a potential electrode pair while keeping the current electrodes fixed, i.e. a gradient technique. Such work was carried out in Sweden in 1906 and onwards, initially using Daft and William's method and equipment (Pettersson, 1907), and later by equipment made locally (Bergström, 1913). Conrad Schlumberger started his pioneering work on electrical prospecting in 1912, and approximately at the same time Wenner developed the same idea in the USA (Schlumberger, 1920; Kunetz, 1966).

The resistivity method is based on measuring the potentials between one electrode pair while transmitting DC between another electrode pair (Fig. 1). The depth of penetration is proportional to the separation between the electrodes, in homogeneous ground, and varying the electrode separation provides information about the stratification of the ground. The measured quantity is called apparent resistivity. Interpreting the resistivity data consists of two steps: a physical interpretation of the measured data, resulting in a physical model, and a geological interpretation of the resulting physical parameters.

---

*E-mail address:* torleif.dahlin@tg.lth.se (T. Dahlin).

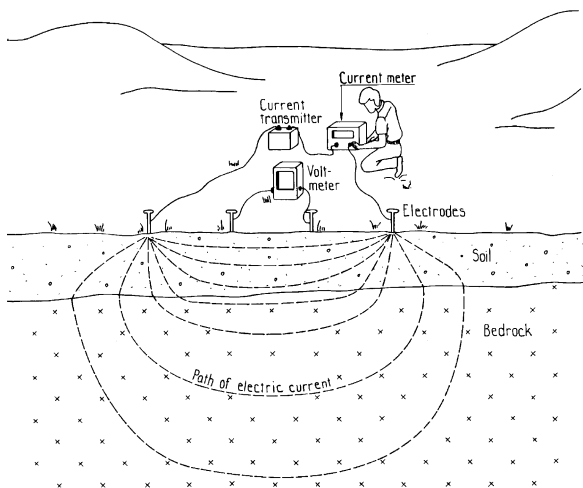

Fig. 1. Sketch showing principle of DC resistivity measurement (modified from Robinson and Coruh, 1988).

3. 1D techniques

3.1. Data acquisition

One dimensional (1D) surveying is carried out either as profiling or vertical electrical sounding (VES). Profiling means moving a constant spacing electrode array along a line and plotting the variation against profiled distance. VES involves increasing the electrode separations around a mid-point, usually with a logarithmic electrode separation distribution, in order to find the layering of strata. The principle of VES, was established in the 1920s (e.g. Gish and Rooney, 1925). The field data acquisition was generally carried out moving two or four of the electrodes used, between each measurement, which is rather time consuming.

3.2. Data interpretation

At first the apparent resistivity data was plotted against electrode separation and interpreted qualitatively through visual inspection and rules of thumb, as shown by an example in Fig. 2. The first method of quantitative interpretation was curve matching, where the data was plotted on double logarithmic diagrams and matched against 2 or 3 layer master curves. By the use of auxiliary point diagrams it was possible to interpret sequences of several layers (Stefanescu et al., 1930; Langer, 1933; Slichter, 1933; Flathe, 1955).

The development of the linear filter theory and digital computers opened the door to computer based interpretation techniques in the 1970s (e.g. Ghosh, 1971). Initially the trial and error method was used, where the interpreter tried to find the “best” fit between measured data and the model response by adjusting layer

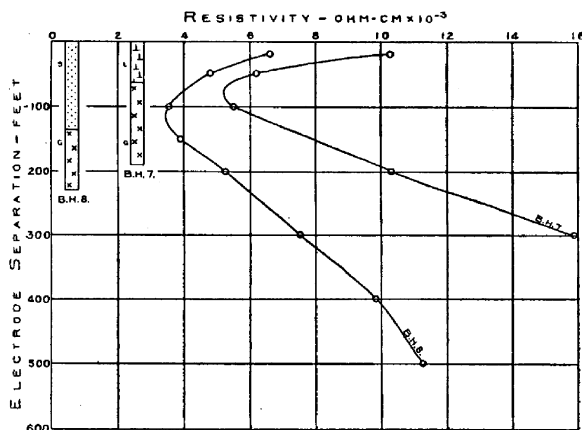

Resistivity curves for boreholes 7 and 8. G, granite. S, sandstone. L, limestone.

Fig. 2. Example of resistivity soundings from western Zimbabwe (then Southern Rhodesia) with drilling logs superimposed (from Shaw, 1935). Observe that resistivity scale shows apparent resistivity.

thicknesses and resistivities. This was followed by automatic inversion by software based on linear inverse theory, which also allowed development of analysis based on the covariance matrix of the inversion problem. The latter is important as it provides an automatic means of analysing how well a model is determined (e.g. Johansen, 1977; Christensen, 1986).

Data acquisition was almost uniquely carried out manually till the 1980s, i.e. four electrodes were placed in the ground and moved manually, between each data point measured on the sounding curve, which is labour intensive and slow. Thus, imaging was until recently limited to either mapping the variation of apparent resistivity over a surface using one, or a few different, electrode separation(s), or compiling quasi-2D sections from a rather limited number of VES.

Use of multi-electrode systems for the data acquisition allows a dramatic increase in field productivity so that one person rather than three can conveniently carry out soundings with limited layouts. At first, systems with manual switching appeared (Barker, 1981), and eventually the computer-controlled systems with automatic measurement and data quality control (e.g. Dahlin, 1989).

3.3. Example: Newcastle resettlement, Zimbabwe

An example of a resistivity sounding VES with alternative model interpretation and geological interpretation is shown in Fig. 3. The data were measured in a weathered Basement area in southern Zimbabwe, with granitic and gneissic rock. As illustrated by the alternative layer models, both few and many layer models can fit the data set. Alternative geological

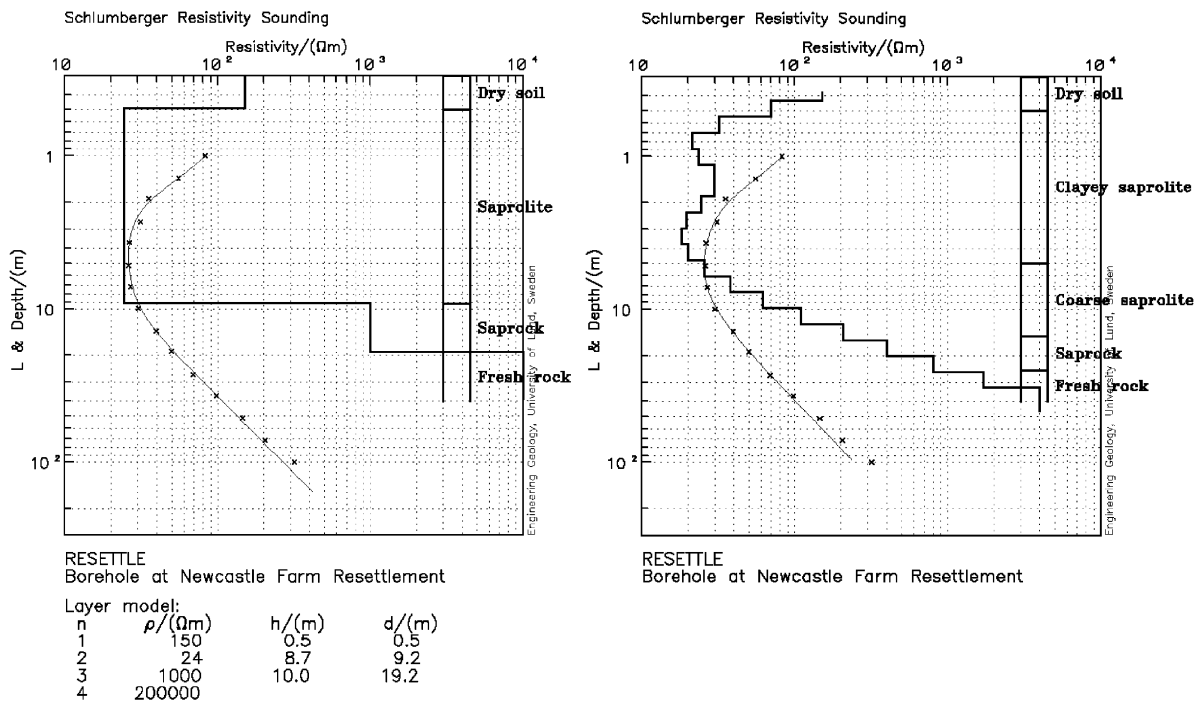

Fig. 3. Example of resistivity sounding from weathered Basement terrain in Zimbabwe with alternative inverted layer models and geological interpretation, (a) few-layer model and (b) many-layer model. Diagrams show layer models (interpreted true resistivity distribution) as well as measured field data and model responses (apparent resistivity) (Dahlin, 1993).

interpretations are indicated in Fig. 3a and b, respectively, and in this particular case a many layer approach may be more suitable due to the often gradual nature of weathering profiles.

#### 4. 2D techniques

The advent of automated data acquisition and inversion in recent years has increased the practical applicability of resistivity imaging tremendously. The method is now widely used in engineering and environmental application in some countries (e.g. Denmark).

2D resistivity imaging requires data to be recorded with many different electrode separations along a line. It is important to have a dense enough data cover laterally and in terms of electrode separations to recover complex structures in the ground (e.g. Griffiths and Barker, 1993; Dahlin and Loke, 1998), which demands the use of automated multi-electrode data acquisition systems to be practical.

##### 4.1. Multi-electrode data acquisition

Computer-controlled data acquisition systems (see Fig. 4) generally consists of a resistivity instrument, a

relay switching unit, a computer, electrode cables, various connectors and electrodes (e.g. Overmeeren and Ritsema, 1988; Griffiths et al., 1990; Dahlin, 1993). In some cases two or more components are housed in the same box, e.g. a computer integrated with the instrument. Some systems employ intelligent switches at each electrode take-out instead of a central switching unit. The number of electrode channels of the switching device range from around 25 and up, where 64 is a typical figure, and the electrode take-out spacing varies from less than 1 to 25 m or more depending on the application.

In field survey the electrode cables are rolled out and electrodes are connected to it, after which the data acquisition software automatically checks the electrode contact and scans through a pre-defined measurement protocol. Extension of the line is achieved through a roll-along technique, in which part of the layout is shifted for example, by quarter of the total layout length and new measurements are added.

##### 4.2. Towed array data acquisition

An entirely different concept is to acquire data with an electrode array that is being towed behind a vehicle. This concept has been developed for marine (e.g. Taylor,

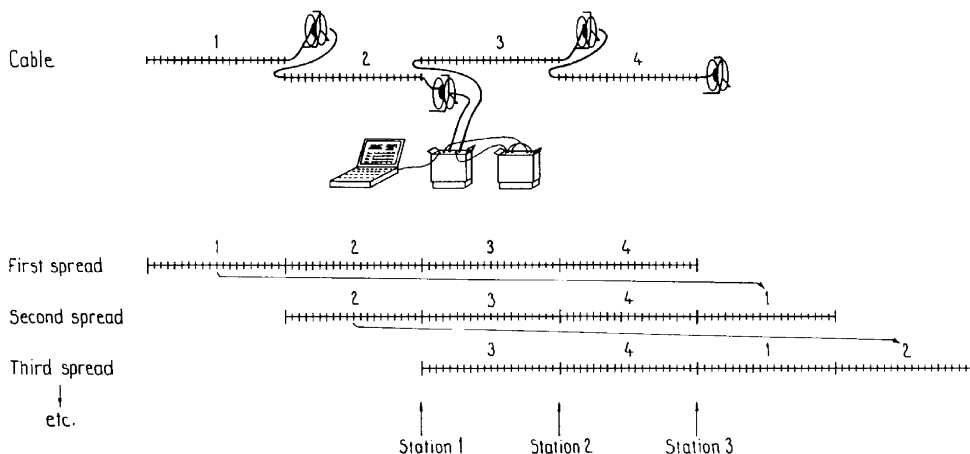

Fig. 4. Sketch outline of computer-controlled data collection system, where each mark on cables indicates electrode position. Figure also shows principle of moving cables when using roll-along technique (modified from Overmeeren and Ritsema, 1988). Total layout length varied between 40 m and 800 m for data presented here.

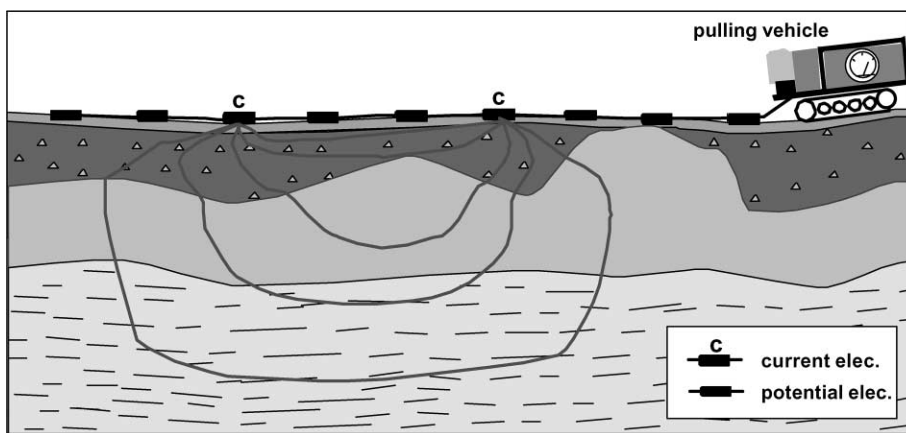

Fig. 5. Sketch of pulled array system (Christensen and Sørensen, 1998).

1992) as well as land based applications (Christensen and Sørensen, 1998). Fig. 5 shows the principle design of the latter type of system. In both cases a cable with a number of electrodes is used, where one electrode pair is used for transmitting current while over several electrode pairs are used for measuring the potentials. A combination of normal and reciprocal Wenner and Schlumberger, and other arrays, may be used. The advantage of this concept is a possibility of high speed of surveying and high lateral resolution, but a limited depth cover for logistical reasons.

Panissod et al. (1998) use an approach where the wheels of a carriage towed behind a vehicle are used as electrodes, providing data of high lateral resolution for e.g. archaeological applications.

#### 4.3. Data interpretation

The large amounts of data produced by multielectrode systems require automated data handling and processing. Automatic inverse numerical modelling techniques (inversion) based on the finite difference or finite element methods for the forward calculations have been developed in response to this need (e.g. Oldenburg and Li, 1994; Tsourlos, 1995; Loke and Barker, 1996a). In these, the subsurface is divided in cells of fixed dimensions, the cell size normally increasing with depth, for which the resistivities are adjusted iteratively until an acceptable agreement between the input data and the model responses is reached. Various approximate schemes have been presented to reduce the large

computational efforts associated with the sensitivity matrix used in adjusting the model, e.g. the quasi-Newton method (Loke and Barker, 1996a), but these are generally most suitable for small resistivity contrasts. Topography is handled either by correction, i.e. transformation of the data before and after inversion, or by modelling the topography directly in the grid.

A few examples from different fields of application are presented below. In all examples of multi electrode system surveys, the ABEM Lund Imaging System (Dahlin, 1996) was used for the data acquisition and the data processed by means of inverse numerical modelling and plotted as depth sections.

#### 4.4. Example: aquifer mapping at Sawmills, Zimbabwe

Geophysical investigations are being carried out in Matabeleland North, Zimbabwe, with the aim of finding suitable aquifers to provide the city of Bulawayo with water. In a part of the study presented here, an attempt is made to map the hydrogeology in an area around the railway siding Sawmills. The area is covered by basalt, which is mostly weathered on the surface. Outside the Umguza river valley, Kalahari Sands overlie the basalt. The basalt rests on the Upper Karoo sandstone, which is the target aquifer. As a basis for selecting suitable investigation lines, a lineament study was performed before this study (Dahlin et al., 1999a).

Several geophysical methods are being tested, and the total length of multi-electrode resistivity surveying at Sawmills is over 30 km. The data was acquired using 800 m cable layouts to provide sufficient depth penetration, and a combination of Wenner and Schlumberger data was recorded. The result provides models of the resistivity structure that can be correlated to the different units of hydrogeological significance (see example in Fig. 6). The high-resistive middle layer which is visible throughout most of the resistivity section correlates with fresh basalt, and the underlying low-resistive bottom layer is interpreted as the Upper Karoo sandstone. The low-resistive layer in the upper part of the section consists of weathered basalt and in parts alluvium, and the structures in the right part of Fig. 6

suggest at least two generations of basalt with a period of weathering in-between. The results strongly support that identified lineaments are associated with faults. In the centre of the investigated area a major low-resistive zone is clearly visible, which is interpreted as an upfaulted block where the aquifer comes closer to the surface. Surface geological observations, other geophysical results and documentation from 3 deep boreholes (MacDonald, 1970) support the interpretation.

#### 4.5. Example: quality control of ground stabilisation in Sweden

The Kvarnby site, at the outer ring road under construction around Malmö, is characterised by very loose lime sludge that fills a former quarry used for chalk production. In order to make the ground competent enough for road construction, the sludge is stabilised to a depth of 3 m by means of cement that is being mixed into it. Resistivity imaging was performed over a test line twice, where only part of the area was treated at the first occasion and an additional volume had been treated before the second survey. A minimum electrode separation of 0.5 m was used, providing high geometrical resolution. The results (Fig. 7) clearly demonstrate that addition of cement results in a very significant decrease in resistivity a few days after the treatment, which delineates the treated volume. The result also indicates that the stabilisation did not reach the depth claimed by the contractor, see the marked target depth (Dahlin et al., 1999b).

#### 4.6. Example: contaminant delineation at Lernacken, Sweden

Next example is Lernacken sludge deposit in southern Sweden, at the abutment of the Öresund bridge under construction. It consists of fill material of limestone quarry waste and till, which rests on top of glacial till and bedrock consisting of tertiary limestone. There is also municipal waste, and industrial sludge has been deposited in ponds dug out in the fill. Heavily contaminated groundwater is present, with organic

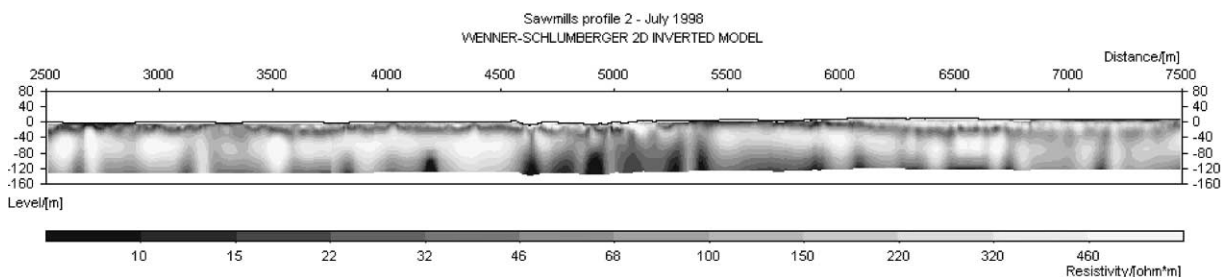

Fig. 6. Part of 10 km long profile at Sawmills, Zimbabwe, presented as inverted resistivity section (Dahlin et al., 1999a).

compounds and heavy metals as major contaminants (Bernstone and Dahlin, 1997).

Resistivity investigations were conducted along 10 lines separated by 20 m over the sludge deposit. An example of the resulting inverted resistivity sections is shown in Fig. 8. The sections that are outside the sludge deposit are rather homogeneous in the upper part (not shown here). The low-resistivity zone coming in from the west, seen at lower depths in all the sections, is due to the saltwater front from the nearby Öresund. A number of low-resistive zones corresponding to sludge ponds are clearly visible in the sections within the sludge deposit (exemplified in Fig. 8).

4.7. Example: aquifer vulnerability mapping in Denmark

An example resulting from a pulled array continuous electrical sounding (PACES) survey is shown in Fig. 9. The aquifers of the western part of Denmark where the survey was carried out consists of fluvial glacial deposits, partially overlain by clayey tills. Clayey tills of sufficient

thickness overlying the aquifer provide a protection against pollution for the aquifers, and hence, mapping of the continuity and thickness of the protective clayey top layers is essential for assessing the vulnerability of the aquifers. DC resistivity has proved a powerful tool for such mapping, and in the open farmland terrain that characterises Denmark rapid field data acquisition can be carried out using the PACES method (Møller and Sørensen, 1998).

In Fig. 9 the resistivity results are displayed as depth slices at different depths below the surface (Sørensen et al., 1999). The data from the individual lines were inverted using the lateral constrained inversion (LCI) algorithm (Auken et al., 2000) with fixed layer thicknesses, and the resistivity models from the different layers contoured to provide maps of the resistivity in the depth intervals. Areas of continuous low resistivity indicate good protection against pollution, whereas areas of higher resistivity correlate with coarse sediments reaching the surface thus, providing rapid infiltration paths for pollutants. This approach is now used

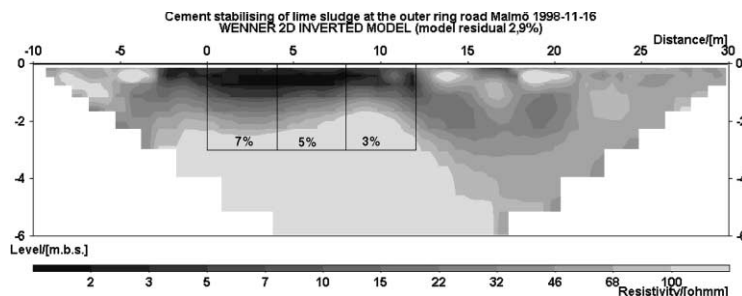

Fig. 7. Resistivity imaging from area treated with cement stabilisation, where claimed extension of treated volume is marked along with cement percentage (Dahlin et al., 1999b).

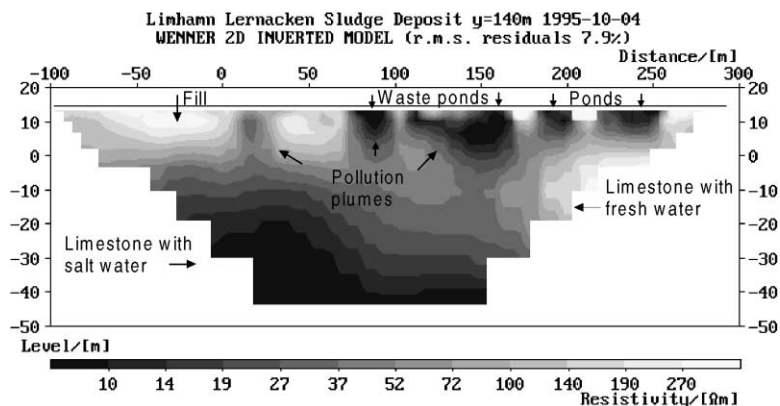

Fig. 8. Linnacken sludge deposit. Example of inverted depth section, where this profile was measured through sludge deposit (modified from Bernstone and Dahlin, 1997).

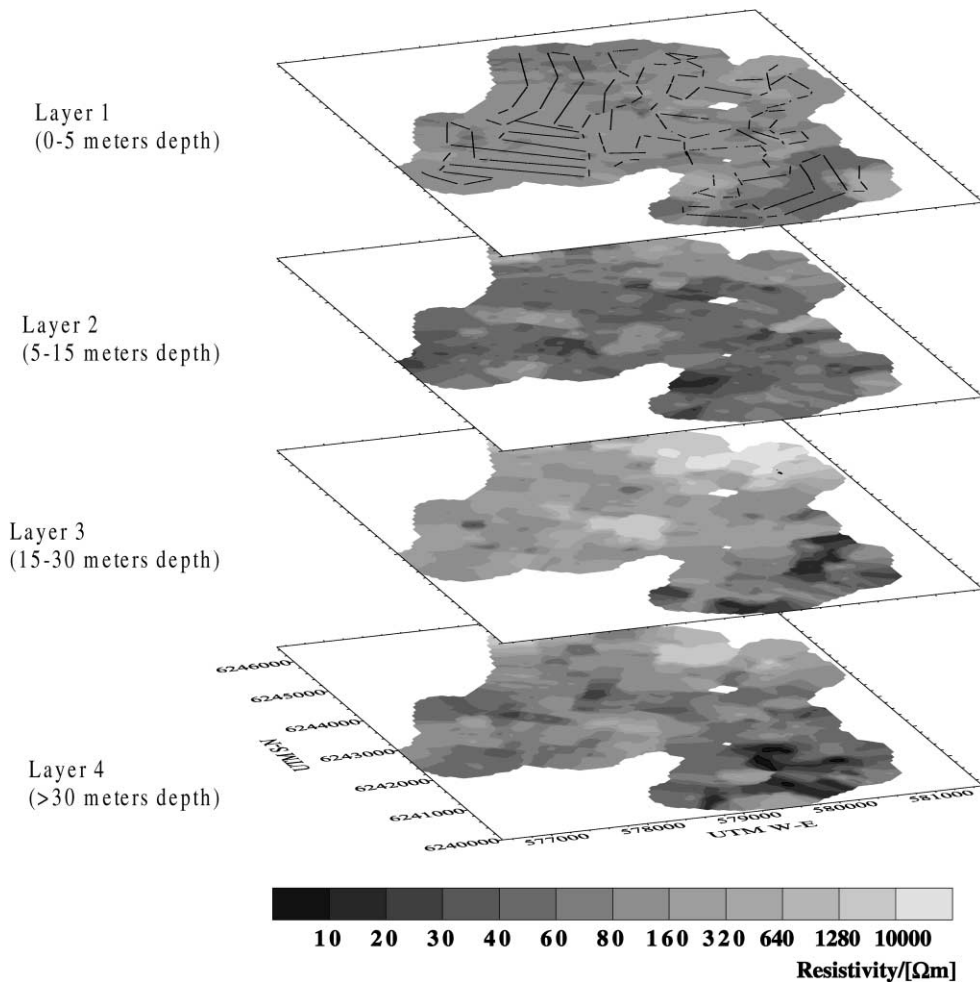

Fig. 9. Example of pulled array results from Hornslet in Denmark, presented as depth slices of resistivity of ground (Sørensen et al., 1999).

routinely in Denmark, in combination with other methods such as multi-electrode resistivity surveying and transient electromagnetic sounding, within a national mapping of the groundwater resources.

## 5. 3D and borehole techniques

### 5.1. Data acquisition

In order to attain 3D information on the subsurface a grid of electrodes can be laid out, and measurements taken with the electrodes aligned in different directions. However, the number of independent electrode combinations that can be measured increases very rapidly with the size of the grid, and data acquisition becomes very time consuming with a single channel instrument. This

calls for more powerful data acquisition systems, based on multi channel techniques, in order to efficiently measure the required amount of data for practical application. This in turn will put new demands on data processing (Fig. 10).

### 5.2. Data interpretation

Research and development on forward and inverse modelling methods for 3D resistivity imaging techniques are underway. The principles are the same as those for the 2D case, but the demand on computational power is much higher and the practical application of 3D techniques is still in its infancy (e.g. Li, 1992; Oldenburg and Li, 1994; Zhang et al., 1995; Loke and Barker, 1996b).



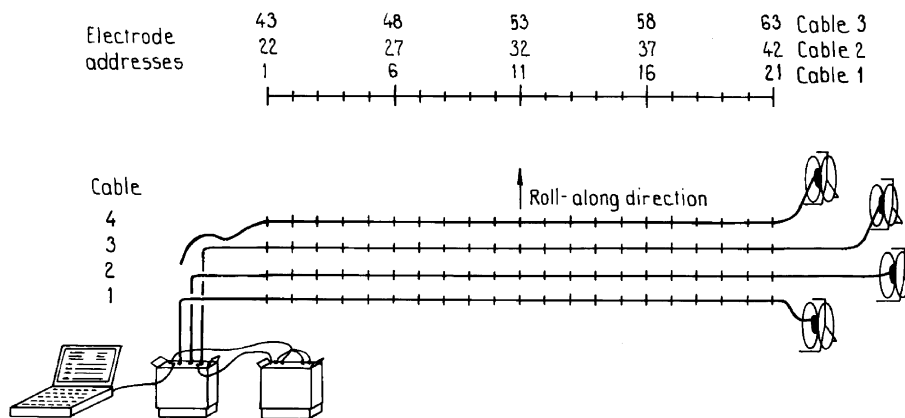

Fig. 10. Sketch of 3D multi-electrode survey layout. By using more electrode cables than shown in figure, and connecting these sequentially to switching unit, measurements can be taken in both  $x$  and  $y$  direction for number of different electrode separations (Dahlin and Bernstone 1997).

### 5.3. Example: 3D survey for contaminant delineation at Lernacken

An example of a model resulting from a 3D data set is presented in Fig. 11. The data was measured over a part of the sludge-pond site presented above, using a 3D roll-along technique that allowed measurement of a larger electrode grid than the switching unit capacity. The pole-pole array was used, and measurements were taken in orthogonal directions. The data set was inverted using a 3D-inversion routine similar to the 2D-inversion described above. The low resistive areas at the surface correspond to the position of the former sludge ponds, and contaminant migration is indicated in, e.g., the far right corner of slice three from the top. At the bottom of the section, the low resistivities are interpreted as an effect of saline water from the nearby sea (Dahlin and Bernstone, 1997).

### 5.4. Borehole techniques

One of the limitations of surface resistivity surveying is the decreasing resolution with depth. Furthermore, for large depth penetration very long layouts are needed, and presence of conductive layers at the surface can still reduce the depth penetration of the method. One way to get high resolution at depth, and overcome depth limitations, is to carry out measurements with arrays of subsurface electrodes, often called resistivity tomography. Research and development is being carried out on 2D as well as 3D borehole tomography (e.g. LaBreque et al., 1996; Ramirez et al., 1996; Slater et al., 1997; Brown and Slater, 1999).

## 6. Conclusions

The development of resistivity imaging techniques has been rapid in the last years, and this development can be expected to continue. For data acquisition techniques, an optimisation of measurement parameters and electrode configurations can be expected, including surface as well as borehole configurations. The development of multi-channel measuring techniques will also speed up and improve the resolution of standard resistivity surveying in future.

2D and 3D modelling and inversion techniques will continue to develop, and more efficient and powerful algorithms are envisaged. The rapid development of computers will also be of major importance for the practical application of advanced inversion methods for imaging purposes.

There is a large development potential in the combination of different geophysical or other parameters, for example DC resistivity and inductive EM data or resistivity and seismic data, where joint inversion can theoretically narrow down the model uncertainties substantially. Inclusion of a priori data in 2D and 3D inversions would be another way of reducing the ambiguities in the inverted models.

## Acknowledgements

Sida/SAREC funded the work at Sawmills presented above. The fruitful co-operation with colleagues and students from Lund University, the University of Zimbabwe in Harare and the National University

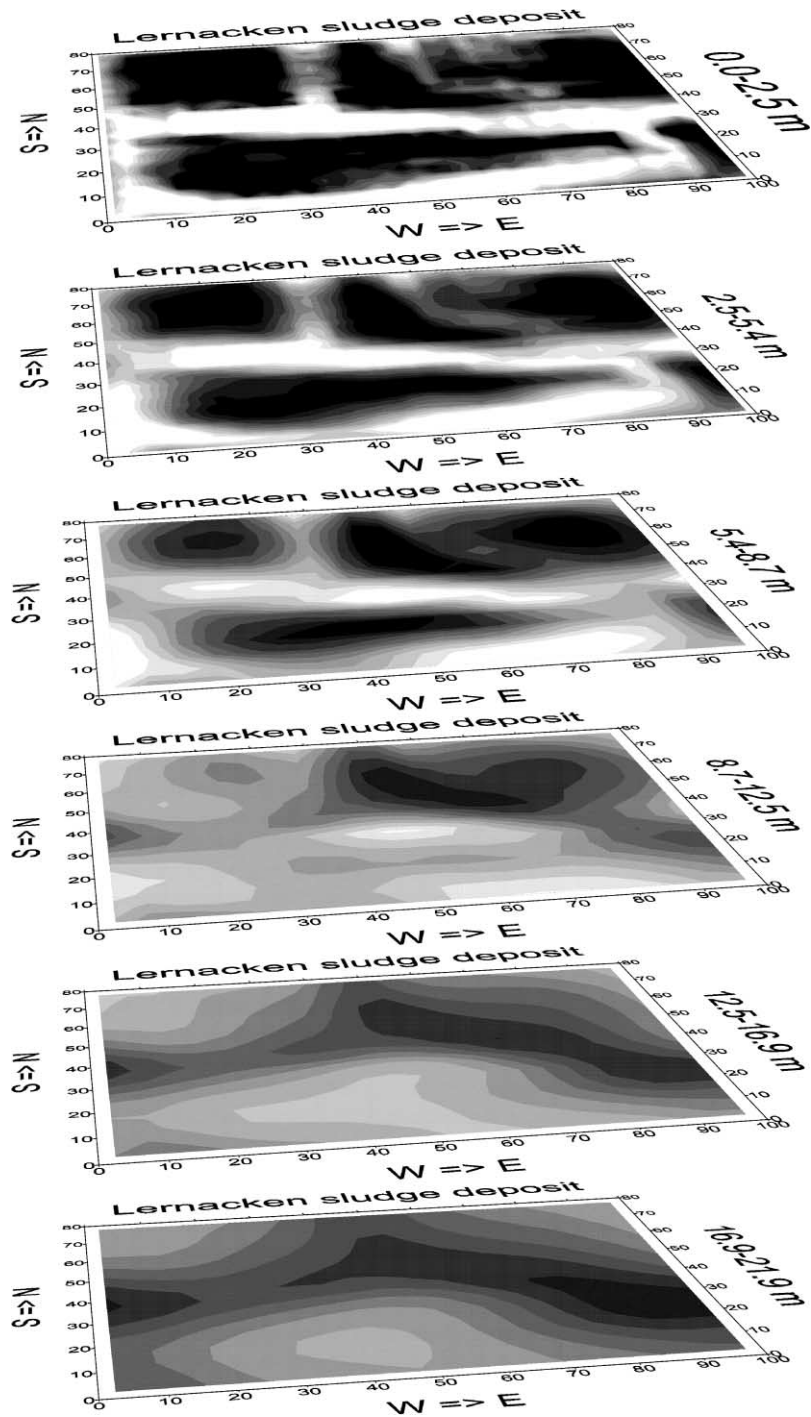

Fig. 11. Depth slices from model based on 3D roll-along survey carried out over part of Lernacken sludge deposits (Dahlin and Bernstone, 1997).

of Science and Technology in Bulawayo is highly appreciated. Thanks are due to Esben Auken and Peter Thomsen at Aarhus University for providing the PACES example.

## References

- Auken, E., Thomsen, P., Sørensen, K.I., 2000. Lateral constrained inversion (LCI) of profile oriented data. *Proceed-*

- ings of the Sixth Meeting on Environmental and Engineering Geophysics. September 3–7, 2000, Bochum-Germany, EL06, 2pp.
- Barker, R., 1981. The offset system of electrical resistivity sounding and its use with a multicore cable. *Geophysical Prospecting* 29, 128–143.
- Bergström, G., 1913. Försök med elektrisk malmletning. *Sveriges Geologiska Undersöknings Årsbok Stockholm* 7 (6), 1–10.
- Bernstone, C., Dahlin, T., 1997. DC resistivity mapping of old landfills: two case studies. *European Journal of Engineering and Environmental Geophysics* 2 (2), 121–136.
- Brown, D., Slater, L.D., 1999. Focused packer testing using geophysical tomography and CCTV in a fissured aquifer. *Quarterly Journal of Engineering Geology* 32, 173–183.
- Christensen, N.B., 1986. The geoelectrical sounding method: a historical review of interpretation techniques and the interpreter's evaluation of the method, in twentyfive years of geology in Aarhus. In: Møller, J.T. (Ed.), *Geological Essays, GeoSkrifter* 24, Aarhus University, pp. 91–102.
- Christensen, N.B., Sørensen, K.I., 1998. Surface and borehole electric and electromagnetic methods for hydrogeological investigations. *European Journal of Engineering and Environmental Geophysics* 3 (1), 75–90.
- Dahlin, T., 1989. The development of a cable system for vertical electrical sounding and a comparison of the Schlumberger and Offset Wenner methods. Licentiate Thesis LUTVDG/(TVTg-1005)/1-77, Lund University, 1989, 77pp.
- Dahlin, T., 1993. On the automation of 2D resistivity surveying for engineering and environmental applications. Doctoral Thesis, ISRN LUTVDG/TVDG-1007-SE, ISBN 91-628-1032-4, Lund University, 187pp.
- Dahlin, T., 1996. 2D resistivity surveying for environmental and engineering applications. *First Break* 14 (7), 275–283.
- Dahlin, T., Bernstone, C., 1997. A roll-along technique for 3D resistivity data acquisition with multi-electrode arrays. *Proceedings SAGEEP'97*, Reno, Nevada, Vol. 2 March 23–26 1997, pp. 927–935.
- Dahlin, T., Glatz, D., Persson, N., Gwaze, P., Owen, R., 1999a. Electrical and magnetic investigations of deep aquifers in North Matabeleland, Zimbabwe. *Proceedings of the Fifth Meeting on Environmental and Engineering Geophysics*, Budapest, 5–9 September, 2pp.
- Dahlin, T., Loke, M.H., 1998. Resolution of 2D Wenner resistivity imaging as assessed by numerical modelling. *Journal of Applied Geophysics* 38 (4), 237–249.
- Dahlin, T., Svensson, M., Lindh, P., 1999b. DC resistivity and SASW for validation of efficiency in soil stabilisation prior to road construction. *Proceedings of the Fifth Meeting on Environmental and Engineering Geophysics*, Budapest, 5–9 September, 2pp.
- Flathe, H., 1955. A practical method of calculating geoelectrical model graphs for horizontally stratified media. *Geophysical Prospecting* 3 (3), 268–294.
- Ghosh, D.P., 1971. The application of linear filter theory to the direct interpretation of geoelectrical resistivity sounding measurements. *Geophysical Prospecting* 19, 192–217.
- Gish, O.H., Rooney, W.J., 1925. Measurement of resistivity of large masses of undisturbed earth. *Terrestrial Magnetism and Atmospheric Electricity* 30 (4), 161–188.
- Griffiths, D.H., Barker, R.D., 1993. Two-dimensional resistivity imaging and modelling in areas of complex geology. *Journal of Applied Geophysics* 29, 211–226.
- Griffiths, D.H., Turnbull, J., Olayinka, A.I., 1990. Two-dimensional resistivity mapping with a computer-controlled array. *First Break* 8 (4), 121–129.
- Johansen, H.K., 1977. A man computer interpretation system for resistivity soundings over a horizontally stratified earth. *Geophysical Prospecting* 25 (4), 667–691.
- Kunetz, G., 1966. *Principles of Direct Current Resistivity Prospecting*. Gebrüder Borntraeger, Berlin, 103pp.
- LaBreque, D.J., Miletto, M., Daily, W., Ramirez, A., Owen, E., 1996. The effects of noise on Occam's inversion of resistivity tomography data. *Geophysics* 61, 538–548.
- Langer, R.E., 1933. An inverse problem in differential equations. *American Society of Mathematics Journal* 39, 14–28.
- Li, Y., 1992. Inversion of three-dimensional direct current resistivity data. Ph.D. Dissertation, University of British Columbia, Vancouver, British Columbia, 165pp.
- Loke, M.H., Barker, R.D., 1996a. Rapid least-squares inversion of apparent resistivity pseudosections by a quasi-Newton method. *Geophysical Prospecting* 44 (1), 131–152.
- Loke, M.H., Barker, R.D., 1996b. Practical techniques for 3D resistivity surveys and data inversion techniques. *Geophysical Prospecting* 44 (3), 499–524.
- MacDonald, D., 1970. The development of railway borehole water supplies on the Bulawayo-Dette section since 1950. *The Rhodesia Science News* 4 (12), 398–406.
- Møller, I., Sørensen, K.I., 1998. A new approach for fast 2-D geoelectrical mapping of near-surface structures. *European Journal of Environmental and Engineering Geophysics* 2 (3), 247–261.
- Oldenburg, D.W., Li, Y., 1994. Inversion of induced polarization data. *Geophysics* 59, 1327–1341.
- Overmeeren, R.A., van Ritsema, I.L., 1988. Continuous vertical electrical sounding. *First Break* 6 (10), 313–324.
- Panissod, C., Dabas, M., Hesse, A., Jolivet, A., Tabbagh, J., Tabbagh, A., 1998. Recent developments in shallow depth electrical and electrostatic prospecting using mobile arrays. *Geophysics* 63–5, 1542–1550.
- Petersson, W., 1907. Om malmsökande medelst elektricitet. *Jern-Kontorets Annaler* 2–3, 153–171.
- Ramirez, A., Daily, W., LaBreque, D.J., Roelant, D., 1996. Detection of leaks in underground storage tanks using electrical resistance methods. *Journal of Environmental and Engineering Geophysics* 1, 189–203.
- Robinson, E.S. and Coruh, C., 1988. *Basic Exploration Geophysics*, Wiley, New York, 562pp.
- Schlumberger, C., 1920. *Étude sur la Prospection Électrique du Sous-sol*, Gaultier-Villars et Cie., Paris, 94pp.
- Shaw, S.H., 1935. A study of the resistivity method in connexion with the investigation of underground water supplies in the Nata Reserve, Southern Rhodesia. *Transactions Institute of Mining and Metallurgy* 44, 3.
- Slater, L., Binley, A., Brown, D., 1997. Electrical imaging of fractures using ground-water salinity change. *Ground Water* 35, 436–442.
- Slichter, L.B., 1933. The interpretation of the resistivity prospecting method for horizontal structures. *Physics* 4, 307–322.

- Stefanescu, S., Schlumberger, C., Schlumberger, M., 1930. Sur la distribution électrique potentielle autour d'une prise de terre pontuelle dans un terrain à couches horizontales, homogènes et isotropes. *Journal de Physique et du Radium* 1 (4), 132–140.
- Sørensen, K. I., Thomsen, P., and Auken, E., 1999. 8-kanals slæbegeoelektrisk kortlægning ved Hornslet. Århus, Geofysisisk Afdeling, Geologisk Institut, Århus Universitet. Rapport 199908002, 27pp.
- Taylor, R.W., 1992. Continuous electrical resistivity surveys along the lake Michigan and Green Bay Coastlines of Wisconsin. *Proceedings of the SAGEEP'92*, Chicago, pp. 129–143.
- Tsourlos, P., 1995. Modelling, interpretation and inversion of multielectrode resistivity survey data. Ph.D. dissertation, Dept. of Electronics, University of York, York, U.K. 315pp.
- Zhang, J., Mackie, R.L., Madden, T.R., 1995. 3D resistivity forward modelling and inversion using conjugate gradients. *Geophysics* 60 (5), 1313–1325.