



LUND UNIVERSITY

Proceedings for the CIB W099 Achieving Sustainable Construction Health and Safety,

Aulin, Radhlinah; Ek, Åsa

2014

[Link to publication](#)

Citation for published version (APA):

Aulin, R., & Ek, Å. (Eds.) (2014). *Proceedings for the CIB W099 Achieving Sustainable Construction Health and Safety*, [Publisher information missing].

Total number of authors:

2

General rights

Unless other specific re-use rights are stated the following general rights apply:

Copyright and moral rights for the publications made accessible in the public portal are retained by the authors and/or other copyright owners and it is a condition of accessing publications that users recognise and abide by the legal requirements associated with these rights.

- Users may download and print one copy of any publication from the public portal for the purpose of private study or research.
- You may not further distribute the material or use it for any profit-making activity or commercial gain
- You may freely distribute the URL identifying the publication in the public portal

Read more about Creative commons licenses: <https://creativecommons.org/licenses/>

Take down policy

If you believe that this document breaches copyright please contact us providing details, and we will remove access to the work immediately and investigate your claim.

LUND UNIVERSITY

PO Box 117
221 00 Lund
+46 46-222 00 00

**CIB W099 International Conference on
Achieving Sustainable Construction Health and Safety
2-3 June 2014
Lund University, Lund, Sweden
Ingvar Kamprad Design Centre (IKDC)**



**International Council
for Research and Innovation
in Building and Construction**



*Proc. CIB W099 Achieving Sustainable Construction Health and Safety,
Lund, Sweden, 2-3 June 2014*

**Proceedings of
CIB W099 International Conference
*Achieving Sustainable Construction
Health and Safety***

**2-3 June 2014
Lund University, Sweden**

ISBN: 978-91-7623-005-3

Edited:
Radhlinah Aulin & Åsa Ek
Division of Construction Management
Building Sciences
Lund University
P.O. Box 118
SE-221 00 Lund
Sweden
Tel: +46 46 2224265
Email: radhlinah.aulin@construction.lth.se
Website: www.bekon.lth.se

The Conference

The CIB W099 International Conference on “**Achieving Sustainable Construction Health and Safety**” was held in Lund, Sweden, on 2-3 June 2014. The conference was hosted by the Division of Construction Management and Division of Ergonomics and Aerosol Technology, Faculty of Engineering, Lund University. The venue of the conference was at Ingvar Kamprad Design Centre (IKDC) Lund University.

The main aim of the conference was to enable knowledge and ideas to be exchanged and to promote interdisciplinary cooperation in solving challenging problems regarding construction health and safety. This conference provided an international forum for researchers and practitioners from developed, developing and underdeveloped nations to address fundamental problems and constraints that affect the successful implementation of sustainable construction health and safety (work environment). The objectives of the conference were:

- To encourage and promote collaborative research and development of sustainable construction health and safety throughout the construction process, facilities management and eventual demolition of buildings.
- To ascertain the challenges that the present status of health and safety pose to the construction industry at various stages of the construction process.
- To discuss how construction industry, enterprises, and individual practitioners can meet health and safety challenges.
- To promote, secure and sustain the health, safety and welfare of people at work, as well as minimizing the risk of exposure to health and safety hazards.
- To explore the integration and application of new techniques, technologies and strategies towards attaining verifiable improvements in health and safety in construction.

The conference featured nine keynote speakers as follows:

- Petra Flyborg and Lars Björkeström, Sveriges Byggindustrier - *'A safe working site'*
- Professor Andrew Hale, HASTAM, UK; Safety Science Group, the Netherlands - *Construction Safety Management: Do we know what works?*
- Professor Pranab Nag, Ramakrishna Mission Vivekanand University, India- *Meeting the Challenges of Occupational Health Services in Informal Construction Works*
- Anna-Carin Nordlund and Magdalena Lee Falk, Swedish Work Environment Authority - *Work environment hazards at Swedish construction sites - An inspector's view*
- Hendrik van Brenk, Chief EHS Officer, Skanska USA – *Skanska Safety Road Map*
- Carin Stoeckmann, Managing Director, Byggmästar'n i Skåne - *“Make it work”*
- Demirali Iljazovski, Head of Health, Safety and Environment, Hoffmann A/S (Veidekke) - *Achieving an improved working environment within Hoffmann*

An industry and research panel debate was held discussing the following questions. *How is the construction industry able to achieve a sustainable work environment? What practical steps can be taken and by whom?* There were three streams of parallel technical sessions presenting all 60 papers.

Conference Organisers

The conference was organised by the Division of Construction Management and Division of Ergonomics and Aerosol Technology, Faculty of Engineering, Lund University (LU), in partnership with CIB W099 Safety and Health in Construction. The joint conference chairs were Radhlinah Aulin and Åsa Ek.

Organisation Group

Carlos Martinez, Division of Construction Management, LU
Louise Bildsten, Division of Construction Management, LU
Monika Jingmond, Division of Construction Management, LU
Radhlinah Aulin, Division of Construction Management, LU
Rikard Nilsson, Division of Construction Management, LU
Robert Ågren, Division of Construction Management, LU
Sara Strand, Division of Construction Management, LU
Jessika Sellergren, Division of Ergonomics and Aerosol Technology, LU
Lena Leveen, Division of Ergonomics and Aerosol Technology, LU
Åsa Ek, Division of Ergonomics and Aerosol Technology, LU

Advisors

Professor Alistair Gibb, CIB W099 Co-Coordinator, CIB W099 Working Commission
Professor Brian Atkin, Division of Construction Management, LU
Dr Michael Behm, CIB W099 Co-Coordinator, CIB W099 Working Commission
Gert-Inge Johansson, OPATINA AB, Arbetsmiljö och Säkerhet

Hosts and Sponsors

Akademiska Hus
Byggrådet
City of Lund
Swedish Research Council for Health, Working Life and Welfare (Forte)
Thage Andersson Byggnads AB

Review Committee

Professor Albert Chan, Hong Kong Polytechnic University, Hong Kong
Professor Alistair Gibb, Loughborough University, UK
Professor Amarjit Singh, University of Hawaii at Mānoa, Hawaii
Professor Anne Landin, Lund University, Sweden
Professor B.J. Hubbard P.E., Purdue University, USA
Professor Chansik Park, Chung-Ang University, Republic of Korea
Professor Christian Koch, Chalmers University of technology, Sweden
Professor Edward Jaselskis, North Carolina State University, USA
Professor Joe Gunning, University Belfast, Northern Ireland
Professor John Gambatese, Oregon State University, USA
Professor John Smallwood, Nelson Mandela University, South Africa
Professor Mats Bohgard, Lund University, Sweden
Professor Patrick X. W. Zou, University of Canberra, Australia
Professor Rafiq Choudhry, King Faisal University, Kingdom of Saudi Arabia
Professor Roland Akselsson, Lund University, Sweden
Professor Steve Rowlinson, University of Hong Kong, Hong Kong
Assoc. Prof. Dr. Chuansi Gao, Lund University, Sweden
Assoc. Prof. Dr. Henry M. Alinaitwe, Makerere University, Uganda
Assoc. Prof. Dr. Nick Blismass, RMIT University, Australia
Assoc. Prof. Dr. Teo Ai Lin, National University of Singapore, Singapore
Assoc. Prof. Dr. Kristian Widén, Lund University, Sweden
Assoc. Prof. Dr. Stefan Olander, Lund University, Sweden
Assoc. Prof. Dr. Åsa Ek, Lund University, Sweden
Dr. Dieter Schlagbauer, Graz University of Technology, Austria
Dr. Fiona Lamari, Queensland University, Australia
Dr. Fred Sherratt, University of Bolton, UK
Dr. Ken-Yu Lin, University of Washington, USA
Dr. Manikam Pillay, Edith Cowan University, Australia
Dr. Michael Behm, East Carolina University, USA
Dr. Nicholas Tymvios, University of North Carolina at Charlotte, USA
Dr. Patrick Manu, City University London, UK
Dr. Radhlinah Aulin, Lund University, Sweden
Dr. Ruwini Edirisinghe, RMIT University, Australia
Dr. Sathyanarayanan Rajendran, Central Washington University, USA
Dr. Simon Smith, University of Edinburgh, UK
Dr. T. Michael Toole, Bucknell University, USA
Carlos Martinez, Lund University, Sweden
Innocent Musonda, University of Johannesburg, South Africa
Kristiina Sulankivi, VTT Technical Research Centre of Finland, Finland
Monika Jingmond, Lund University, Sweden
Philip Bust, Loughborough University, UK
Philip McAleenan, Expert Ease International, UK
Robert Ågren, Lund University, Sweden

Contents

Behaviour-based safety	
Risk Perception and Safety Behaviour: An Ethnographic Study <i>David Oswald, Fred Sherratt & Simon Smith</i>	2
Continuous education in health and safety	
Improving Safety Culture Understanding Using a Computerised Learning Environment <i>Robert S. Cram & Julie-Ann Sime</i>	13
A Real Time Approach to Measuring Corporate Safety Climate <i>Robert S. Cram & Julie-Ann Sime</i>	24
The Role of Simulation-Based Learning in the Occupational Health Training of Younger Construction Workers <i>Netsai Nyateka, Alistair Gibb, Andrew Dainty, Phil Bust & Sharon Cook</i>	35
Health and safety knowledge in complex networked organisations: training the chain <i>Phil Bust, Aoife Finneran, Ruth Hartley & Alistair Gibb</i>	47
Creating an incident free work environment	
An Integrated Framework for Strategic Safety Management in Construction and Engineering <i>Riza Yosia Sunindijo & Patrick X.W. Zou</i>	59
Taking Stock of Zero Harm: A Review of Contemporary Health And Safety Management in Construction <i>Manikam Pillay</i>	70
Progressing Zero Harm: A Review of Theory and Applications for Advancing Health and Safety Management in Construction <i>Manikam Pillay</i>	81
Exploring Prefabrication Facility Safety in the U.S. Construction Industry <i>Sebastian Soto, Bryan Hubbard & Sarah Hubbard</i>	92
Improving Health and Safety through Interventions in Safety Cultures <i>Christian Koch</i>	100

Using a Walkway with Adjustable Inclination to Measure and Assess Slip and Fall Risks	110
<i>Chuansi Gao, Amitava Halder, Ingrid Svensson, Gunvor Gard, Giorgos Nikoleris, Per-Erik Andersson & Måns Magnusson</i>	

CSR, regulations and enforcement

Changing Construction Safety Culture and Improving Safety Outcomes by Design Thinking and Co-Production: Research Proposal and Preliminary Results	118
<i>Patrick X.W. Zou, David Marsh, Mark Evans & Alex Sherrard & Jerry Howard</i>	

Designing for health & safety

Designer's Perceptions of Safe Design and Its Potential for Innovation	129
<i>Ronan McAleenan & Michael Behm</i>	
Healthy construction workers by better workplace design	138
<i>Stephanie Eaves, Diane Gyi & Alistair Gibb</i>	
Improving Construction Health and Safety Management in Structural Alteration and Basement Construction to Existing Structures	147
<i>David Oloke</i>	
Evaluating the Potential and Challenges of Utilising Computational Simulation to Design Safety Management and Culture Interventions	157
<i>Yang Miang Goh & Palak Gupta</i>	
Design Risk Management Practices and Assessment Tools for Safety in Construction: Opportunities for BIM	169
<i>Kihong Ku</i>	
Prevention guide for designers based on analysis of about 2000 accident	180
<i>Alfredo Soeiro, Bianca Silva & Beda Barkokebas</i>	
Integrated Safety in Design	187
<i>Casper Siebken Schultz & Kirsten Jørgensen</i>	
Investigation of fall protection practices in the construction industry of Pakistan	197
<i>Rafiq M. Choudhry, Bilal Tariq & Hamza F. Gabriel</i>	

Occupational health and ergonomic	
Comparative Ergonomic Assessment of Slab Formwork Systems <i>Dieter Schlagbauer & Detlef Heck</i>	208
Insulation of traditional Indian clothing: Estimation of climate change impact on productivity from PHS (predicted heat strain) model <i>Kalev Kuklane, Karin Lundgren, Tord Kjellstrom, Vidhya Venugopal, Jintu Fan & George Havenith</i>	218
Proactive health and safety	
Exploring the Utility of Construction Industry Safety Culture <i>Fred Sherratt</i>	229
The Development of an Automated Multi-Level Safety Climate Benchmarking Tool for Construction Projects <i>Ruwini Edirisinghe, Rita Zhang, Helen Lingard & Frank Boukamp</i>	240
Additional Evidence of the Sustainable Construction Safety and Health (SCSH) Rating System's Effectiveness <i>Sathyanarayanan Rajendran & John A. Gambatese</i>	251
From Zero Accidents to Well-being and Positive Health <i>Valentina Villa, Amarjit Singh & Giuseppe Martino Di Giuda</i>	262
Workplace Stress and Its Impact Analysis for Strategic Stress Management in Construction Project <i>YK Fiona Lamari & Seokho Chi</i>	272
The Motivators for Addressing Construction Health and Safety (H&S): A Hierarchical Perspective <i>John Smallwood</i>	285
Climatic Heat Risk Management in Construction: A Socio-Ergonomic Theory <i>Steve Rowlinson & Yunyan Andrea Jia</i>	296
Thought Consistency Questions in Safety Climate Surveys: A Case Study Example <i>David Oswald, Fred Sherratt & Simon Smith</i>	305
Screening for Fatigue-related Impairment in the Workplace <i>Ronald Powell & Alex Copping</i>	316

Safety on Construction Sites in Areas Subjected to Seismic Risk <i>Renato G. Laganà</i>	308
Distribution of Breaks in the Construction Industry <i>Dieter Schlagbauer & Detlef Heck</i>	337
The Application of Deductive Logic to Determine the Objective Conditions Impacting Upon Cultural Maturity <i>Ciaran McAleenan & Philip McAleenan</i>	348
A Study of the Proactive Occupational Safety and Health Work in a Swedish Construction Company - The Example of Vibration Exposure <i>Åsa Ek & Petra Andersson</i>	360
Temporary Works Accidents - An Investigation of the Role of the Temporary Works Coordinator in the UK. <i>Sarah C Williams, Alistair G.F Gibb & Phil D Bust</i>	371
Investigating Safety Management on Construction Projects <i>Rafiq M. Choudhry</i>	381
Drug and Alcohol Use in the Australian Construction Industry: A Case Study <i>Ehsan Gharaie, Terry Hatzimagas, & Claude Zeina</i>	388
Construction Hazard Prevention: The Need to Integrate Process Knowledge into Product Design <i>Ron Wakefield, Helen Lindgard, Nick Blismas, Payam Pirzadeh, Brian Kleiner, Thomas Mills, Andrew McCoy & Lance Saunders</i>	399
Quality work life	
The Impact of Annual Employee Medicals on a General Contractor (GC) and its Employees' Sustainability <i>John Smallwood & Claire Deacon</i>	411
Reactive health and safety	
The Costs of Construction Site Accidents to Australia's Building Contractors <i>Yingbin Feng, Peng Wu, Xiaohua Jin & Jian Zuo</i>	421
Near-miss reporting among construction workers <i>Radhlinah Aulin & Emma Linderbäck</i>	430

Role of stakeholder	
Analysis of Difference/Similarity between Construction Project Participants' Work Health and Safety (WHS) Risk Perceptions <i>Rita Peihua Zhang, Helen Lingard, Nick Blismas, Ron Wakefield & Brian Kleiner</i>	441
Owner Views on Designer Participation in Construction Safety <i>Nicholas Tymvios & John A Gambatese</i>	453
Owner Role in Safety Performance Improvement: a Case Study of Chinese High-Speed Railway Construction <i>Chunlin Wu, Dongping Fang, Feng Wang & Minglai Xu</i>	463
SME–micro Engagement with Occupational Safety and Health (OSH) - The Role of the Owner-Manager <i>Aoife Finneran, Elaine Yolande Gosling, Alistair Gibb, & Phil Bust</i>	473
Technology and OHS	
An Agent-Based Framework for Modelling Construction Safety Related Behaviours <i>Zhongming Jiang, Dongping Fang & Tao Wang</i>	484
A Construction Safety Education System Based on Interactive Virtual Reality <i>Akeem Lanre Pedro & Chan Sik Park</i>	494
Skill Decay of Wind Turbine Technicians in the use of Rescue and Evacuation Device During Emergenc <i>Billy Hare, Kenneth Lawani & Iain Cameron</i>	505
Nanoparticles - Are They Safe and Why Should We Care Anyway? Introducing A New Research Initiative <i>Alistair Gibb, Phil Bust, Chris Goodier & Mo Song</i>	522
Would the Time-Delay of Safety Data Matter? Real-Time Active Safety System (RASS) for Construction Industry <i>Ruwini Edirisinghe, Helen Lingard, Nick Blismas & Ron Wakefield</i>	532
Virtual Construction Site Safety Monitoring (V-SaM) <i>Edward J. Jaselskis, Michael Behm, Matthew Stimpson & Cordelia Nelson</i>	543
Safety Aspect in Constructability Analysis with BIM <i>Kristiina Sulankivi, Matti Tauriainen & Markku Kiviniemi</i>	554

Formalizing Construction Safety Knowledge for Intelligent BIM-Based Review of Design for Safety <i>Thi Qui Nguyen, Ernest Abbott, David Chua & Yang Miang Goh</i>	565
---	-----

Miscellaneous

Validity and Reliability of Dependent Variables: Considerations for Construction Safety Researchers <i>Michael Behm, Helen Lingard & Jeffrey Bruening</i>	577
The Potential of BIM for Safety and Productivity <i>Teo Ai Lin Evelyn, George Ofori, Imedla Krisiani Tjandra & Hanjoon Kim</i>	586
A Systematic Literature Review of Current Research on Prevention and Protection of Fall from Height <i>Lili Poon, Yang Miang Goh & Zhipeng Zhou</i>	596
Leadership - A Negation of Agency or an Opportunity to Develop Autonomous Action for Workplace Safety <i>Philip McAleenan & Ciaran McAleenan</i>	608
An Effective Remedy -Work Safety Culture <i>U Chit Ko Pe</i>	615
Evaluating the Inadequacies of Horizontal Lifeline Design: Case Studies in Singapore <i>Qiao Wang, Yee Pin Hoe & Yang Miang Goh</i>	628

Behaviour-based Safety

RISK PERCEPTION AND SAFETY BEHAVIOUR: AN ETHNOGRAPHIC STUDY

David Oswald¹, Fred Sherratt² & Simon Smith¹

¹ *University of Edinburgh, King's Buildings, West Mains Road, Edinburgh, EH9 3JN, UK*

² *Anglia Ruskin University, Bishop Hall Lane, Chelmsford, CM1 1SQ*

In the construction industry, poor risk perception has been suggested to being highly influential factor in unsafe behaviours. To explore the influence of risk perception on unsafe acts in construction, an ethnographic approach was undertaken on a major project (+£500m) in the UK. The aim of the study was to identify the importance of risk perception and the factors that influence it. Literature has found two key factors which influence risk perception ratings. These factors are if the risk is unknown (unknown risks are new and unfamiliar) and if the risk is dreaded (a dread risk is an uncontrollable risk which can be catastrophic e.g. a plane crash). Dread and unknown risks are feared and are the factors which cause variance in the risk perception ratings across all national cultures. Literature has also established that voluntary risks (risks that are one's own choice e.g. driving a car) are more likely to be taken than involuntary risks. Voluntary risks are strongly linked to controllability, where the risk is under personal control. Applying this knowledge to the construction industry, this paper has concluded that since risks taken in the industry are usually under the individual's control, non-dread and known, construction risks are more likely to be tolerated and can be under-rated. As this is the case across all national cultures, this conclusion can be made for the global construction industry. In this study, thirty different unsafe acts were collected over a one-year period and findings suggested that a poor risk perception was almost always a perceived influence. The perception of risk can be altered by a variety of factors but common factors found to influence risk perception were benefit and work pressures. These two factors were usually linked as shortcuts were taken to benefit from saving time.

Keywords: Benefit, Construction, Ethnography, Risk Perception, Time Pressure.

INTRODUCTION

Risk perception in the construction industry has been suggested to have a high influence on unsafe behaviours (Oswald et al., 2013). The aim of this study was to investigate the importance of risk perception in construction and the factors that influence risk perception. Through an ethnographic approach and application of the psychometric paradigm, unsafe acts that occurred on a large construction project (+£500m) in the UK were investigated.

CONTEXTUAL LITERATURE: RISK PERCEPTION

Risk perception is a subjective assessment of the probability of an event happening and the severity of the consequences of such an event. Risk perception phenomenon became a growing concept in the 1960s when it was identified as a main factor in

¹ D.Oswald@ed.ac.uk

public opposition to new technologies and nuclear power. Early work into risk perception by Starr (1969) found that individuals would accept risks that are 1000 times greater if they are voluntary (e.g. driving a car) rather than involuntary (e.g. a nuclear disaster). Starr's quantitative margin was later challenged by researchers, but it is generally agreed that voluntary risks are more likely to be accepted than involuntary risks. Despite Starr's early findings there was little research on voluntary risk taking in the decade that followed (Lyng, 1990). The research that was conducted gave different interpretations of Starr's findings, which ultimately led to the psychometric paradigm, discussed in a later section. There has been an abundance of study on risk perception with three theoretical families being developed: anthropology/sociological approaches or 'culture theory', 'psychological approaches' and 'interdisciplinary approaches'. Psychological and cultural theories currently dominate the field of risk perception (Sjoberg et al., 2004).

Anthropological/Sociological Approach (Culture Theory)

This approach suggests that perceptions are socially constructed by ways of life and cultural values. The Cultural Theory of risk (Douglas & Wildavsky, 1982) identifies four 'ways of life', with each corresponding to a certain social structure and outlook on risk. The four ways of life include: hierarchal, individualist, egalitarian and fatalist. The theory has not been widely accepted by researchers with Douglas (1992) even stating that the theory is controversial.

Interdisciplinary Approach: Social Amplification of Risk Framework

The Social Amplification of Risk Framework (SARF) is a combination of research in the theories of sociology, psychology, anthropology and communications. The framework aims to explain how risk perceptions are amplified. The media are an important link in communication chains and have strong effects on the public's risk perception (Wahlberg & Sjoberg, 2000). They are also often seen as irresponsible, with interest in negative information and a special inclination towards low probability but high risk consequences i.e. dread risks. The news media across the nations vary their interest and tend to pay most of their attention to their own national problems (Mazur, 2006). There is also evidence to suggest that risk perceptions in nations change across time. In a study by Mazur (2006), perceptions were measured in 1993 and then again in 2000 in various nations. For nearly all hazards the Filipinos, Spanish, Israelis, Russians and Japanese had increased their ratings of danger considerably while the Germans, Bulgarians and Irish reduced their ratings. The study revealed that trends changed when news coverage changed e.g. when there was an increase in coverage of environmental danger in a nation, the perceptions of environmental danger increased; and when the coverage decreased, the perceptions decreased. This was the case for nine out of ten countries – only Ireland avoiding the trend.

Psychological Approach - The Psychometric Paradigm

This approach concentrates on how people process information. In early works it was concluded that people sort and simplify information; but this shortcut can lead to biases in evaluation and comprehension (Kahneman & Tversky, 1974). This framework was built on more recently and became the so-called psychometric paradigm, which in the field of risk analysis, has been the most influential model created (Siegrist et al., 2005) and compared to culture theory it has been fairly successful in predicting and explaining perceived risk (Sjoberg et al, 2004).

The psychometric paradigm attempts to address why different people perceive hazards in different ways. Using this paradigm, the study of diverse groups revealed that psychometric scaling can identify and quantify differences and similarities in attitudes and risk perceptions amongst different groups (Slovic et al., 1985). To understand risk perception, the paradigm aims to reveal the factors which affect risk perception. An important paper (Fischhoff et al., 1978) compiled nine dimensions from literature, two of which: dread risks and unknown risks have been found to create the variance in risk rating perceptions.

Dread Risks

Dread risks are low possibility but high consequence events such as the devastating terrorist attack on September the 11th 2001. It appears that people try to avoid dread risks - situations that are dreaded and are where many people can be killed at one time, as opposed to situations where the same number of people may be killed but over a longer period to time (Slovic, 1987). However, avoiding dread risks may cause deaths as a study by Gigerenzer (2004) estimates that 350 lives were lost on the roads in the 3 months following the attacks, as people avoided the dread risk of flying. In construction, Bohm (2010) found that perceived risk is linked to the perceived dread rather than the likelihood. Fatalities in the construction industry generally occur sporadically over a long period of time and hence dread risks are uncommon.

Unknown Risks

The novelty of the risk is the other major factor found to create the variance in perceptions. Risks that are unknown have a higher risk factor associated with them due to their uncertainty, while risks that are familiar have a lower risk factor associated with them. Uncertainty is a psychological concept closely related to risk and is an important mediator of human response in unknown scenarios (Sjoberg, 2004).

Dread and Unknown risks in many National Cultures

There have been studies investigating risk perceptions across different cultures and nationalities. The United States were the first country to publish findings on risk perception (reported by Fischhoff et al., 1978) and in 1983 the first comparative risk perception study was compiled when research was carried out in Hungary (Englander et al., 1986). This research aimed to use the same methodology to that of Fischhoff et al. (1978) in order to compare the findings in Hungary with that of the US. The results were very similar and had strong correlations with the two dominant factors (dread and unknown) in the US studies. The most striking difference between the two nationalities was that the mean of the judgements of risk was almost double in American citizens than in their Hungarian counterparts. Soon after, another study in Norway was undertaken (Teigen et al., 1988). Norway's judgements of risk were lower than the US but higher than Hungary's. Their risk profile matched the Americans more closely than the Hungarians, in that, like the US citizens, they had greater concern for drugs and narcotics. There have also been studies in Asia as well as the United States and Europe. In 1989, Keown found that the mean risk ratings of Hong Kong students were not significantly higher than the US but differed greatly in the type of hazards. Yet despite this variance the two factors 'dread' and 'unknown' were again concluded dominant. This cross national study was also replicated in Poland (Goszczyńska et al., 1991) with the same result: dread and unknown factor dimensions concluded dominant. The Polish risk judgement ratings were slightly higher than the Norwegians but lower than Hong Kong Chinese and the Americans and hence

considerably higher than the Hungarians. In 1993 Karpowicz-Lazreg and Mullet replicated the study in France but also investigated education and gender impacts of risk perception. The mean risk judgement ratings were very similar to that of the Americans. Similar conclusions were also found in a later French study (Poumadere et al., 1995). Studies have found that Americans, Hong Kongese, Bulgarian, Japanese, Brazilian (Nyland, 1993), French and Polish subjects have high mean risks and Swedes (Nyland, 1993), Russians, Romanians and Hungarians have low ratings (Boholm, 1998). This evidence indicates that though the risk ratings vary throughout the globe as a mean and for different risk activities, the two dominant factors 'dread' and 'unknown' constantly have a significant influence.

Other Applicable Dimensions of the Psychometric Paradigm

There are two other dimensions of the psychometric paradigm that are most applicable to the types of risks in this study: personal impact or benefit and controllability.

It has been found that the greater the benefit for an individual, the greater the tolerance of risk is amongst individuals (Slovic et al., 1982; Gregory & Mendelsohn 1993). This is apparent across many disciplines including construction. A simple example being: the mining industry is perceived a very high risk environment for workers yet reports (e.g. Moss, 2011) have suggested that workers appear unfazed by the risks, with the dangers being offset by the financial benefits. Controllability is linked to voluntary risk-taking (Sjoberg, 2001). Risks such as being a passenger on a plane could be deemed 'voluntary' but because the individual is not in control of the risk, the risk level associated is higher. In construction, most risks are taken by individuals that are in 'control'.

METHOD

Research methods in the construction industry have been rather narrow, with Phelps and Horman (2010) arguing they are inadequate for exploring the complex interactions which lie at the roots of the industries widespread problems. Dainty (2008) has suggested that through qualitative and interpretative research, richer insights into the industry may be found. Ethnography – where the researcher observes and writes about a culture from the point of view of the subject – is an established qualitative research method that has become part of the research approaches used in the construction industry (see Pink et al., 2013). This method can provide extensive and in-depth findings, but there are also limitations to this approach. Though it was not a restriction in this study, ethnography is time consuming. It is also strongly reliant upon establishing rapport with subjects, which can be challenging especially in industries such as construction - an industry that Loosemore (1998) describes as 'confrontational'. The main drawback is related to reliability, as the natural setting cannot usually be reproduced (Nurani, 2008). Criticisms such as unreliability and lack of validity of findings are often associated with ethnography and while some ethnographers ignore such criticisms, others address them but this often requires different techniques from those that were originally used (LeCompte and Gotz, 1982). The investigation used an ethnographic approach on a large civil engineering project in the UK (+£500m) utilising a 'moderate participation observer' stance. DeWalt and DeWalt (1998) suggest this can provide a good balance of involvement – for example, through observations and conversations with those involved – and necessary detachment to remain objective.

Thirty different unsafe acts were identified throughout a one year period and ranged in severity from potential first aid attention to a potential fatality. The acts selected were chosen as they were useful examples of the affect of risk perception on personal safety within the wider ethnographic study. To determine the importance and influence of risk perception, the unsafe acts were initially coded into factors which had influenced the behaviour. These factors were previous highlighted in literature and consisted of: poor management style, alcohol & drugs, poor risk perception, substandard design, inexperience, time pressure, national culture, lack of training, risk taking tolerance, tiredness, confidence and thrill seeking. Acts that were likely to be or could have been influenced by any of the factors were coded with that factor. This data was then coded and further explored using the computer software programme, Nvivo. It was deemed that all of the thirty acts were likely to be or could have been influenced by a poor risk perception.

The psychometric paradigm was then applied to the thirty examples taken from this study to attempt to investigate poor risk perception. The conclusions of this analysis were consistent: all were dread risks, known risks and almost all were undertaken by individuals under personal control of the risk. The vast majority also had personal benefit that usually involved saving time. To further demonstrate this finding the remainder of this paper provides first a discussion of ten of the unsafe acts recorded for this research followed by a quantitative application of the psychometric paradigm to these examples.

ANALYTICAL NARRATIVE

Below are ten examples of the influences on risk perceptions found in this case study are discussed in detail.

Risk Compensation

Risk compensation is a controversial theory (O'Neil, 1998) that suggests there is a certain level of risk at which people can accept that they are exposed to. Therefore, if a safety measure is introduced that reduces the risk; people can adjust their behavioural response i.e. take on more risk. This can lead to an unjustified lower level of perceived risk and hence more risky behaviour (Sheehy and Chapman, 1987). For example, if seat belts are worn (the safety level increased), then the individuals can drive faster to reach their destination (behaviour change due to increased safety from seat belt). Therefore, according to this theory, the introduction of a safety measure is, in the long run, eliminated by human behavioural response (Peltzman, 1975). There were a couple of examples which to some extent supported the risk compensation theory. Following the issue of flame-resistant (but not fire-proof) overalls to hot works operatives, there were two incidents where operatives were set on fire (*example 1*). From a discussion with one of the operatives, he stated that he had never been set on fire in 25 years until he was given the fire protection. An investigation into the incident by safety advisors found that the operatives had taken a more comfortable but riskier stance during the work – a behaviour which increased the likelihood of this accident. This behaviour and the poor quality of the clothing resulted in the fire. Soon after, a similar incident occurred with another worker who was also just given fire resistant clothing. The other example occurred when a harnessed scaffolder was seen 'monkeying around' and using inappropriate access around the scaffold (*example 2*). When questioned, the scaffolder thought his behaviour was safe because he was harnessed on, but this is not good practice and is a clear example of safety measures

affecting behaviours through risk compensation. In these circumstances the perception of risk had been altered by the introduction of a measure implemented with the intention of improving safety.

Risk Taking, Confidence, Trust and Thrill-Seeking

Risks may be taken if it is perceived risk is low, even if the benefit for taking such a risk is low. A common unsafe act that occurred on this construction project was breaking a well-known safety rule: workers are not permitted to use mobile phones in non-designated areas (*example 3*). The likelihood of an accident occurring due to lack of concentration (e.g. walking and talking on the phone and tripping) does increase when on a mobile phone but nevertheless it is still unlikely. Despite workers knowing that this behaviour is not acceptable and the benefit usually being low (e.g. you do not have to walk to a safe place and return the call) this risk is often taken. The more often the risk is taken, the more confident the risk-taker becomes - a factor which is known to have a negative impact on risk perception (Siegrist et al., 2005). Confidence can lead to complacency: for example one operative was observed hammering while not looking at what he was doing, instead having a conversation with his colleague (*example 4*). A more severe example occurred when the driver of a transportation boat (full of workmen) became confident and relaxed with the surrounding risks. A near miss occurred on a dark evening when the transportation boat narrowly avoided a tanker vessel (*example 5*). It is good practise for the transportation boat to be crossing the river at a 90 degree angle, but instead the boat took a quicker route and crossed at around a 45 degree angle (an example of benefit). The radar was on and working but the driver did not notice the tanker. The transportation boat carried on at a fair speed until it was radioed urgently by the tanker, and the transportation boat turned sharply left narrowly avoiding a collision. Though this could have been perceived as a dread risk, (many fatalities were possible) in post-incident witness statements, none of the passengers said they felt in danger which is also a sign of general trust influencing risk perception. The passengers trust the drivers, since they the journey has been completed safely numerous times. High levels of trust have been found to reduce risk perceptions (Siegrist et al., 2005).

Individuals that become so relaxed and confident with surrounding risks can even partake in risk-taking for thrills. Through ethnography this can be difficult to conclude whether risks were taken for thrills; but one example of this did occur when an operative avoided a ladder instead using the tubing on a work elevated platform to climb up around 8ft (*example 6*). On inquiry he self-confessed that he was very bored with the work he had been doing and did it for excitement. Over-confidence can become dangerous and effect individual's risk perceptions, especially when they are being exposed to the same risks. Confidence usually comes with experience and can lead to relaxed safety behaviours, but inexperience can also effect risk perceptions. For example, an inexperienced banksman was standing next to the rear of a tipping wagon, while it unloaded (*example 7*). The banksman was at risk from falling material and could not be seen by the driver. It was only the banksman's second day on the job, and his lack of experience influenced his perception of the risks. A mixture of an experienced but cautious individual represents a good balance for risk perceptions.

Voluntary Risks, Benefit & Work Pressures

A factor present in many of the unsafe acts is voluntary risk taking. Individuals feel more comfortable with voluntary risk taking (Starr, 1969) since they are in control. A common unsafe act that occurred was the delivery drivers breaking the speed limits

on-site (*example 8*). Since the drivers feel they are in complete control of this behaviour the risk is more likely to be accepted. Another influence on this behaviour is benefit. Drivers can be paid by delivery, which encourages risk-taking behaviour because of the greater benefit. Benefit systems are known to encourage risk-taking behaviour (Sawacha et al., 1999) but there were such systems used on this construction project ‘unofficially’ and unknown to senior management. Such unofficial benefit systems improve relationships between operatives and their supervisors but distort perceptions of risk. Good relationships with the operatives are very important for supervisors, as in a time of need they can rely on their workforce e.g. if extra work was required to be completed at the weekend. Work and time pressures can push middle-management to taking more safety risks. For example, there was an occasion where a beam delivery was due at the beginning of the following week. If the team were not ready for this delivery, they would need to wait a month for the next one. Therefore to stick to the tight schedule, around 20 operatives were working in an area that should have only had four or five workers in it (*example 9*). Such time pressures are a fairly common factor that can influence risk perception and risk taking. Even short time savers can cause an incident, for example, a crane cut a corner across a non-ground bearing surface (despite knowing to stay on the tarmac) and crushed the service cables running underground (*example 10*). These examples indicate a link between time pressures and benefit – work pressures cause risk-taking for benefit. The inverse relationship between perceived risk and perceived benefit has been found to be strengthened when time pressures are involved (Finucane et al., 2000).

REFLECTIONS: APPLYING THE PSYCHOMETRIC PARADIGM

The psychometric paradigm uses numerous qualitative dimensions of risk. According to Jenkin (2006), the most commonly used include: immediacy, expert knowledge, controllability, novelty, delayed, certainly fatal, increasing, preventability, inequitable, affects future generations, global catastrophe, catastrophic potential, easily reduced and observability. Almost all unsafe acts in this study fell into the same categories for the above dimensions. For example, none of the unsafe acts could cause ‘global catastrophe’, they can all usually be ‘easily reduced’, consequential effects are almost always known immediately and are very unlikely to affect future generations. The other four dimensions (voluntary, known, dread, personal impact) that Jenkin’s highlights are most applicable to the unsafe acts that have been discussed. The psychometric paradigm has highlighted two clear factors when individuals are rating risks: dread and unknown risks. The unknown and dread dimensions are applicable because they have been found to cause the variance in risk perception ratings.

This study suggests that in the construction industry it is rare that there are any dread risks. As dread risks are perceived as higher risk than non-dread risks, individuals can under-rate these non-dread risks. The other factor is unknown risks. Unknown risks are perceived as a higher risk than known. This study suggests that in the construction industry the vast majority of risks are known, usually because the risks re-occur again and again e.g. working at height. Such known risks can become under-rated, especially if an individual is constantly exposed to the same risks and becomes confident and relaxed around them. Unknown risks and dread risks are feared, and as the summary in Table 1 illustrates, all the risks were known and all were non-dread,

meaning that they could be under-rated. The potential boat crash could have caused a multiple deaths, yet perhaps somewhat surprisingly from evidence gathered in the witness statements, this risk was not dreaded.

Table 1 - The ten discussed unsafe acts analysed by the most relevant dimensions in the psychometric paradigm

	Known	Voluntary	Control	Catastrophic Potential	Dread	Personal Impact	Severity
Operative on caught on fire	Yes	Yes	Yes	No	No	Yes	Major injury or Death
Scaffolder 'Monkeying around'	Yes	Yes	Yes	No	No	Yes	Death
Mobile walk and talk	Yes	Yes	Yes	No	No	Yes	Major injury or Death
Hammering and not looking	Yes	Yes	Yes	No	No	No	Minor injury
Potential boat crash	Yes	Yes	No	Yes	No	Yes	Multiple Deaths
Climbing scaffold tube	Yes	Yes	Yes	No	No	Yes	Death
Banksman behind tipping wagon	Yes	Yes	Yes	No	No	No	Death
Delivery drivers speeding	Yes	Yes	Yes	No	No	Yes	Death
Overcrowded beam delivery	Yes	Yes	Yes	No	No	Yes	Major injury or Death
Crane crushing services	Yes	Yes	Yes	No	No	Yes	Damage

Individuals have been found to be more willing to accept 'voluntary risks'. This is heavily linked to 'controllability', where less risk is associated with situations that are under personal control (Sjoberg, 2001). There was one example in this study where individuals were not in control - the passengers in the potential boat crash scenario. In the vast majority of situations individuals were in control, which is associated with less risk and hence scenarios could be under-rated. In many of the situations, there was personal benefit distorting the perception of risk. The type of personal benefit was almost always to save time. The delivery driver speeding is perhaps the most obvious example, but there are many others such as: the crane diverting off the tarmac to cut a corner (but crushing the underground services), the overcrowded work area to finish work in time for the beam delivery, the scaffolder 'monkeying around' to move quickly around the scaffold and the supervisor walking and talking on his mobile phone rather than walking to a safe area and returning the call.

CONCLUSIONS

Literature has found that risks that are voluntary and under personal control are more likely to be taken and that non-dread and unknown risks can be under-rated. From applying this knowledge to the construction industry it can be concluded that since the vast majority of the risks in this case study were voluntary, under personal control and non-dread and known risks in construction, they were more likely to be accepted and under-rated. This conclusion could be significant since a poor perception of risks has been suggested to being the most common factor in the unsafe acts investigated in this study. Other common influences on the perception of risk were found to be work pressures and benefit, and these are often strongly linked. Work pressures often cause risk-taking for timesaving benefits. Reducing these time pressures is difficult to achieve in practise, but the findings suggest that to improve safety in the industry potential improvements should be investigated.

REFERENCES

- Bohm, J (2010) Risk Perception and Risk-Taking Behavior of Construction Site Dumper Drivers, International Journal of Occupational Safety and Ergonomics (JOSE) 2010, Vol. 16, No. 1, 55-67

- Boholm, A (1998). Comparative studies of risk perception: a review of twenty years of research *Journal of Risk Research* 1 (2), 135–163
- DeWalt, Kathleen M. & DeWalt, Billie R. (1998). Participant observation. In H. Russell Bernard (Ed.), *Handbook of methods in cultural anthropology* (pp.259-300). Walnut Creek: AltaMira Press
- Douglas, Mary and Aaron Wildavsky (1982). *Risk and Culture*. University of California Press
- Douglas, Mary (1992). *Risk and Blame: Essays in Cultural theory*. New York: Routledge.
- Englander, T., Farago, K., and Slovic, P. A. (1986) Comparative analysis of risk perception in Hungary and the United states, *Social Behaviour* 1, 55–66.
- Finucane, M., Alhakami, A., Slovic, P., Johnson, S., (2000) The Affect Heuristic in Judgements of Risks and Benefits, *Journal of Behavioural Decision Making* 13: 1-17
- Fischhoff, B., Slovic, P., Lichtenstein, S., Read, S., & Combs, B. (1978). How safe is safe enough? A psychometric study of attitudes towards technological risks and benefits. *Policy Sciences*, 9, 127-152.
- Gigerenzer, G., (2004). Dread Risk, September 11, and Fatal Traffic Accidents, *Psychological Science*, 15 (4), 286-287
- Gregory, R. and Mendelsohn, R. (1993) Perceived Risk, Dread, and Benefits, *Risk Analysis*, Vol. 13, No. 3
- Goszczyńska, M., Tyszka, T., and Slovic, P. (1991) Risk perception in Poland: a comparison with three other countries, *Journal of Behavioural Decision Making* 4, 179–93.
- Jenkin, C. M. (2006). Risk Perception and Terrorism Applying the Psychometric Paradigm, *The Journal of Naval Postgraduate School Centre For Homeland Defense and Security*, Volume 2
- Karpowicz-Lazreg, C. and Mullet, E. (1993) Societal risk as seen by the French public, *Risk Analysis* 13, 253–58.
- Keown, C.F. (1989) Risk perceptions of Hong Kongese vs. Americans, *Risk Analysis* 9, 401–5.
- LeCompte, M and Goetz, J (1982), Problems of Reliability and Validity in Ethnographic Research, Volume 52, No. 1, pp. 31-60
- Loosemore M (1998) The methodological challenges posed by the confrontational nature of the construction industry. *Engineering, construction and architectural management*, 5(3), 285-293
- Lyng, S. (1990) Edgework: A Social Psychological Analysis of Voluntary Risk Taking, *American Journal of Sociology* , Vol. 95, No. 4, pp. 851-886
- Mazur, Allan (2006) Risk Perception and News Coverage across Nations, *Risk Management*, 8(3): 149-174
- Moss (2011) BBC News article, accessed 28th November 2013, available at: <http://www.bbc.co.uk/news/uk-england-15445418>
- Nurani, L. (2008). Critical review of ethnographic approach. *Journal Socioteknologi Edisi* 14 Tahun, 7.
- Nyland, L.G. (1993) *Risk Perception in Brazil and Sweden*, Stockholm: Center for Risk Research.
- O’Neill B, Williams A (June 1998). “Risk homeostasis hypothesis: a rebuttal”. *Inj. Prev.* 4 (2): 92–3

- Oswald, D., Sherratt, F., Smith, S. (2013) Exploring factors affecting unsafe behaviours in construction , Arcom Conference, 335-344
- Peltzman, S. (1975) The Effects of Automobile Safety Regulation. *Journal of Political Economy*, 83, 667-725
- Phelps, A. and Horman, M (2010) 'Ethnographic theory-building research in construction', *Journal of Construction Engineering and Management*, 136: 58-65
- Pink, S., Tutt, D., Dainty, A. (2013). *Ethnographic Research in the Construction Industry*. Routledge
- Poumadere, M., Mays, C., Slovic, P., Flynn J., and Johnson S. (1995) What lies behind public acceptance? Comparison of US and French perceptions of the nuclear power option, in *The Nuclear Power Option*.
- Sawacha, E., Shamil, N., Fong, D. (1999) Factors affecting safety performance on construction sites, *International Journal of Project Management*, Vol 17, Issue 5
- Sheehy, N.P. and Chapman, A.J., (1987). Industrial accidents. In: Cooper, C.L. and Robertson, I.T. (Eds.), *International Review of Industrial and Organizational Psychology*. Wiley, New York, pp. 201-227.
- Siegrist, M., Keller, C. and Kiers, H (2005). A New Look at the Psychometric Paradigm of Perception of Hazards, *Risk Analysis*, Vol. 25, No. 1
- Sjoberg, L. (2001). Limits of knowledge and the limited importance of trust. *Risk Analysis*, 21, 189–198. Check
- Sjoberg, L., Moen, Bjorg-Elin., Torbjorn, Rundmo (2004) Explaining risk perception. An evaluation of the psychometric paradigm in risk perception research
- Slovic, Paul, Baruch Fischhoff, Sarah Lichtenstein. (1982): “Why Study Risk Perception?” *Risk Analysis* 2(2) 83–93
- Slovic, P., Fischhoff, B., and Lichtenstein, S. (1985). Characterising Perceived Risk. In C. H. C. Kates and J. X. Kasperson (Eds.), *Perilous Progress: Managing the Hazards of Technology*. Boulder: Westview Press.
- Slovic, P. (1987) Perception of Risk. *Science*, 236, 280-285
- Starr, C. (1969) Social Benefits versus Technological Risks” in *Science* Vol. 165, No. 3899. (Sep. 19, 1969), pp. 1232–1238
- Teigen, K. H., Brun, W. and Slovic, P. (1988) Societal risks as seen by the Norwegian public, *Journal of Behavioural Decision Making* 1, 111–30.
- Tversky, Amos and Daniel Kahneman. “Judgment under Uncertainty: Heuristics and Biases.” *Science* 185(4157) (September 1974): 1124–1131
- Wahlberg, A. & Sjoberg, L. (2000) Risk Perception and the media, *Journal of Risk Research*, Volume 3, Number 1, 31-50(20)

Continuous education in health and safety

IMPROVING SAFETY CULTURE UNDERSTANDING USING A COMPUTERISED LEARNING ENVIRONMENT

Robert S. Cram² and Julie-Ann Sime¹

¹ Department of Educational Research, Lancaster University, Bailrigg, Lancaster LA1 4YW, UK

This paper presents the design of a safety culture training tool, a novel approach to providing management with the knowledge to measure and evaluate their organisation's safety culture through the use of a Safety Culture Learning Environment (SCLE).

The SCLE reproduces the outputs of a fictitious oil company of c. 1000 people over a 5 year period. Running on a bank of 16 computers and with the data presented to the participants on a video wall, the SCLE provides the attendees with the opportunity to address a broad range of safety culture related issues. Participants learn how to interpret and fit together the various pieces of the safety culture jigsaw. Armed with these new insights, they are much better equipped to obtain a clearer picture of the safety culture of their own organisations

Playing the role of CEO, the participants interact, through the SCLE's built-in email system, with their virtual departmental "management team". Similarly, responding to questions from, and providing reports to, the "board of directors" are also a part of the educational experience.

At the end of the 8 hour session, participants will have gained not only 5 years' worth of safety culture "exposure" but will have the skill set required to significantly improve safety culture in their own organisations.

Keywords: Safety, Climate, Culture, Evaluation, Management, Education, Training

INTRODUCTION

One of the most significant observations made by Lord Cullen in his report (Cullen 1990, p301) following the Piper Alpha tragedy, and something which is just as true today as it was then, is:

"I am convinced from the evidence that the quality of safety management is fundamental to off-shore safety. No amount of detailed regulations for safety improvements could make up for deficiencies in the way that safety is managed."

Since 1990, the changes brought about by the Cullen Report have led to substantial improvements in industrial safety performance. These improvements have occurred as discrete step changes. Fennell (2006) identifies four different step changes, three of which have brought industry from where it was several decades ago to its current performance level, with the fourth improvement step highlighting the need for effort in the areas of behaviour and culture (Figure 1).

² r.cram@lancaster.ac.uk

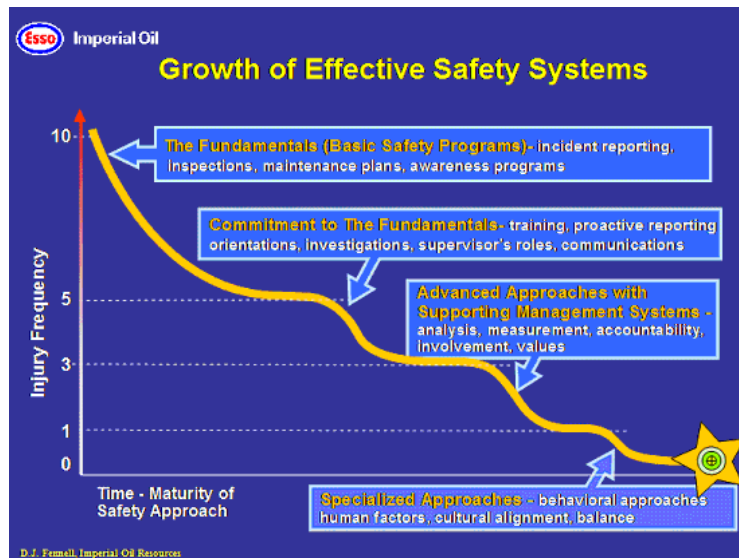

Figure 1. Growth of effective Safety Systems; D.J. Fennell. Imperial Oil. Reprinted with permission

Traditionally, safety culture is evaluated using a questionnaire which is sent to the members of the organisation concerned. Various analysis techniques are then used in an attempt to identify the safety culture of the organisation. These have met with differing degrees of failure leading some to question their validity.

Researchers have begun to express the opinion that it may not be possible to use tools such as safety culture surveys to actually provide a useful measure of organisational safety culture. Glendon and Stanton (2000 p4) claimed “*Questionnaires or similar measures will be inadequate to measure all aspects of organizational culture*”. Friedman and Amoo (1999 p12) hope that their work “*has sensitised consumers of survey research ... to the difficulties inherent in research based on rating scales*”. Hale (2000 p10) suggested that “*No researchers can yet claim that the questionnaires and scales they have developed and used are anything like fully validated*”. While Guldenmund (2000 p226) points out that “*There is no real consensus on how to describe the climate or culture of an organisation*” and concludes “*Questionnaires have not been particularly successful in exposing the core of an organisational safety culture*” (Guldenmund 2007, p723).

Weigmann et al., (2002 p8) define safety culture as –

“Safety culture is the enduring value and priority placed on worker and public safety by everyone in every group at every level of an organization. It refers to the extent to which individuals and groups will commit to personal responsibility for safety, act to preserve, enhance and communicate safety concerns, strive to actively learn, adapt and modify (both individual and organizational) behavior based on lessons learned from mistakes, and be rewarded in a manner consistent with these values.”

An alternative, and arguably more astute definition, has been put forward (CCPS, 2011) which suggests that -

“Safety culture is how the organization behaves when no one is watching”.

With potentially billions of dollars at stake as the price of poor safety performance (BP 2011) companies can no longer afford not to understand the underlying safety culture of their organisations. If the shortcomings of traditional approaches render their use inappropriate, then a new way of educating management on the importance of understanding corporate safety weaknesses and corporate safety culture is essential. What is required is a tool that can be seamlessly translated across multiple languages and cultural boundaries; a tool which provides management with a clear understanding of how to measure, monitor and interpret the day to day safety culture of their own organisations.

DESIGNING A SAFETY CULTURE TRAINING TOOL

“When you can measure what you are speaking about, and express it in numbers, you know something about it, when you cannot express it in numbers, your knowledge is of a meagre and unsatisfactory kind; it may be the beginning of knowledge, but you have scarcely, in your thoughts advanced to the stage of science.” – Lord Kelvin (1883)

Never was this more true than in the field of safety performance and safety culture. Even if an accurate and consensual safety culture survey existed, it would only, at best, reflect the status of the organisation at the moment the survey was undertaken (Flin et al., 2000).

A goal of this research was to develop and evaluate a solution to the contemporaneous problems of measuring and evaluating corporate safety culture and communicating the knowledge and skills to senior management. To achieve this, an accurate model of a typical organisation operating in a high risk environment needed to be designed and constructed. Incorporated into the model needed to be data which, at the basic level, would provide the learner not only with accurate insights into the culture of the organisation being managed but which, with the benefit of greater understanding, could be analysed by the participants to reveal the real picture of the underlying safety culture. There were several questions which needed to be answered before the design phase could be commenced, of which the most important were –

- *How should the organisation to be modelled be structured?*
- *Should any tool developed be interactive?*
- *What interaction should there be with the trainer?*
- *Should role players be involved and if so, in what capacity?*
- *What is the optimum time-scale to incorporate into the model?*
- *How long should the process take to complete?*

How should the organisation to be modelled be structured?

If maximum benefit was to be derived from the learning experience, then it followed that the tool should mirror as far as reasonably possibly the structure of a real organisation engaged in the exploration and production of oil and gas. In their paper, Law and Gomas (2001) present a seven-step approach to conducting a successful simulation and this was adopted for the construction of the corporate model used in this research project.

While it was not essential that participants be upstream oil and gas managers themselves, the tool needed to be believable to professionals in that domain or there would always be a high risk of loss of credibility with regard to the model, resulting in a likely rejection of the learning experience as being both unrealistic and built on inaccurate foundations.

From the many departments comprising a typical oil company, Drilling, Production, Well Operations, Maintenance and Logistics were defined as essential. A sixth, Support was included to account for all “non-operational” departments. In reality, each department carries its own operational risks and, to a certain extent, has its own internal version of corporate safety culture as a consequence of its particular discipline and management style. Finally, the Board of Directors was established to provide the participant with an entity to which he was entirely responsible in respect of taking direction and reporting.

Should any tool developed be interactive?

At first glance, the design and construction of a simulator might be seen as the most applicable approach. Fishwick (1995) defines simulation as “The discipline of designing a model of an actual or theoretical physical system, executing the model on a digital computer, and analysing the execution output. Simulation embodies the principle of ‘learning by doing’”. Thomas (2003 p1), describes the “broad agreement from both simulation experts and educational users of computer simulations that the key features of simulations are” that -

- there is a computer model of a real or theoretical system that contains information on how the system behaves.
- experimentation can take place. Changing inputs to the model affects outputs.

While the first point was relatively simple to design and implement, the concept of permitting experimentation rendered the simulation option unworkable. Above all else, the tool had to be credible to both line managers and experienced safety professionals. An interactive simulator would, through necessity, need to incorporate the ability for the learner to effect changes to the model inputs which would manifest themselves in a corresponding increase or decrease in both accident frequency and severity. In the industrial world, no such direct link exists. Deciding in advance which accidents to add or delete from the simulation would expose the tool to valid criticism in respect of its relationship to real life.

In addition to the credibility aspect of designing a simulator, there is hidden knowledge built into the data which the participant learns to interpret. By exposing the internal database to modification through user interaction, it is entirely possible that this knowledge, which is derived from data patterns resulting from daily operational events, could be lost. This would effectively render the simulator useless as a teaching tool as it would no longer be able to reasonably reflect the real world situations about which the participant is learning. For these reasons, designing and constructing a simulator was discarded from the available options.

Constructing a passive emulator was relatively straightforward. According to Thomas’s definition (2003 p6) -

“... an emulator could be seen as an accurate simulation where no approximation has taken place and all features of the original are present in the emulation”.

High realism is definitely critical in the case of any tool being developed to teach safety culture measurement and evaluation. However, if the training exercise remained completely passive throughout, it was likely that participant attention would decline markedly. Indeed, a passive emulator would have been little more than an 8hr video of an organisation's 5 year safety performance.

It was therefore clear that attempting to develop a solution using traditional simulation / emulation approaches was unlikely to succeed.

What interaction should there be with the trainer?

A passive animation of a company in action would fail at every level to deliver the required outcomes and so, while recognising the dangers inherent in permitting user interaction with the raw data, some form of interaction was essential, both to maintain interest and to facilitate evaluation of the participant's changing beliefs, attitudes and knowledge levels as the process continued.

Essential to this process was the creation of an environment where the participant had access to all of the material required to formulate a new frame of reference and was able to test any new frame through discussion and interaction with the trainer and to a lesser extent with his management team. The trainer therefore plays three roles in the SCLE.

- Trainer
- HSE Manager
- Chairman of the Board

In his primary role, the trainer keeps the participants on track. With SCLE 'days' ticking off every 16 seconds the participant not afford to get bogged down in the details. The SCLE was designed to teach senior management about high level corporate safety culture. The details, while essential for realism, were in themselves not particularly relevant to the “big picture” view the participant was obtaining.

When required to assist the participant with technical safety related information, the trainer can role play the participant's HSE Manager. As such, he is there to provide the participant with specialist advice as would be expected in any corporation. This did not extend to writing reports to or answering emails from the “Chairman of the Board” which was still done by the participant as part of the learning experience.

Finally, the trainer played the role of the Chairman of the Board. As part of the learning experience, the participant was required to write end of year safety culture reports for the Board of Directors. In addition, at various points during the course, he was required to make presentations to the board and to answer pre-prepared questions from the Chairman. These questions had been designed around the data / knowledge available to the participant via the video wall and were delivered automatically into his email in-box at the appropriate time.

Should role players be involved and if so, in what capacity?

The inclusion of role players has been shown to have a positive effect on changing learners' opinions (Janis and King 1954) and serious consideration was given to their inclusion as the management team in this type of tool. While some benefit may have derived from that opportunity, the arguments against using role players were much

stronger. Most significant of all of the reasons not to use role players were ‘available time’ and the ‘number of role players’ required. The computer model was intended to generate data representing several years’ worth of operational inputs for a typical company. People however, like to talk and any prolonged discussion on particular issues would be likely to lead to time being wasted, which would almost certainly mean that the model would advance by weeks or even months during the discussion, thereby rendering the issues irrelevant and wasting much analysis time. Six role players for the management team would spend most of their time sitting at the end of a phone with little likelihood of ever being asked even a single question. One person playing all of the managers increases the confusion for the participant as to whom he might be speaking at any particular moment.

Role playing was therefore restricted to the educator alone providing optional replies to emails sent out by the participant at his discretion, written by him but appearing to come from the different managers to whom the original communication had been sent by the participant.

What is the optimum timescale to incorporate into the model?

A year is a short time in the safety performance of an organisation. Similarly 10 years might possibly result in diminishing returns as well as possibly being an unacceptably long period for the learners to participate, since the longer the model time, the more time it would take to complete the training. A 5 year time frame was therefore selected as the best compromise between the conflicts of “corporate time” vs. “participant availability time”.

How long should the process take to complete?

There was a serious “Catch 22” issue with the length of the training session. On the one hand, the target audience would not wish to devote too long on this type of training. On the other hand, if the training period was too short then there was the risk that participants might be overwhelmed with the rate at which data was being delivered to them and possibly experience a degree of cognitive overload. It was finally decided to run the 5 years of the model over an 8 hour period with 1 hour at the beginning for “scene setting”.

COMPONENTS OF THE MODEL

With the questions answered, the next step was to decide which information to incorporate into the model. Safety related data is collected in most organisations. Hidden from normal view within that data is often knowledge about the real functioning of the company. A total of 14 data sets were identified, incorporated and displayed on the video wall –

Clarification note. It would be completely counterproductive to describe in detail the knowledge gained from each component by the participants as this might well detract from the learning experience should any readers find themselves actually participating in the training. It would be akin to giving students the answer to an exam before they take the course. It should be noted however that not all elements were included for what they told the participants. Some elements were included so that participants would learn what these components did not tell them.

Accident Triangle

Conventionally, the accident triangle is used to highlight the differing numbers of fatalities, lost time accidents, recordable accidents etc. which have occurred within an

organisation. A deeper analysis of this data, especially in the distribution of reports, reveals important and enlightening messages regarding the reporting culture of the organisation. Both before and after the training sessions, participants were asked to rank the 14 data screens in the order in which they derived most useful information. In the majority of cases, the triangle was ranked near the top.

Training Records

Raw data on training is of little value other than to show that training had been undertaken. Data in this element included organisational training records, departmental training records, training uptake levels and course difficulty. As the participants progressed through the training, they were introduced to different ways of looking at the data in order to evaluate overall and departmental culture issues. One of the most significant lessons from this module is how different departments within the same organisation may have differing cultures with regard to training.

Poisson Distribution

This data was included to assist participants in understanding what was really happening in their company as opposed to what appeared to be the case. Additionally, this module enabled them to provide satisfactory answers to questions received from the “Board of Directors” on accident frequency anomalies

Total Recordable Injury Rate (*TRIR*)

No company would be without its *TRIR* information and the *SCLE* was no exception. With *TRIR* available for the company and contractors, participants had access to this information whenever required.

Manhours Worked

Displayed at most work site entrances, the manhours worked screen faithfully displayed the manhours worked since the last lost time accidents for the organisation as a whole and by department. This was updated on a daily (every 16 seconds) basis.

Action Tracking

A database of actions to improve safety performance was incorporated into the *SCLE*. Conventionally, this information is used to track when actions which have been raised have been completed. There is however a great deal of insight to be gained by evaluating what drove the actions to be raised in the first place. By considering how actions came to be in the system, participants gained valuable insight into the proactivity or reactivity of their organisation as a whole and by individual departments.

HSE Goals

HSE Goals and progress toward achieving them provide valuable information on the proactivity of the organisation. Hidden messages in goal achievement were revealed to participants as part of their educational experience.

Leading Indicators

Possibly the most complex element of the *SCLE*, this module presented the participant with a direct view of the organisation’s proactivity both overall and by department in terms of achievement towards delivering on a suite of leading indicators. With the opportunity to drill down into the data, participants were able to evaluate their own (as

CEO) overall performance and proactivity as well as that of their individual departments.

Accident Occurrence

A simple module, participants received data on where, when and which contractor had experienced accidents.

Department / Contractor Influence

This element of the SCLE enabled the participant to isolate individual departments or contractors from the overall safety performance of his company and to establish the impact each entity had on the company as a whole.

Safety Management System (SMS) Implementation Deficiencies

The fictitious company modelled in the SCLE has its own OHSAS 18001 (BSI 1999) which is available for participants on demand. Based on the logic that an SMS is designed and implemented to minimise accidents it can be inferred that any accident is the result of a failure in the implementation of one or more elements of the SMS.

Every one of the 200+ accidents in the SCLE database had previously been the subject of a Management System Failure Analysis. Each element of the SMS was displayed in on the video wall. A simple “traffic light” colour coding of “red” = bad, “yellow” = concern, “green” = OK was adopted to highlight to the participants where they should focus their attention with regards to the SMS implementation effectiveness.

SMS Radar Display

The same information was also displayed in the form of a radar plot which provided participants with an alternative view on where issues lay with the implementation of the SMS

Unsafe Act & Unsafe Condition (UAUC) Reporting

The company’s HSE department introduced a UAUC reporting system at a point during the programme. Information on numbers of reports received, classification of reports UA or UC, reports by department and other information was presented to the participants. From this data, participants learned to identify safety culture issues on organisation, department and contract levels.

Continuous Safety Climate

The final module provided a continuous display of the observed safety climate of the company. To describe how this was done would require a much larger paper. Briefly, the safety climate was evaluated after every accident and the revised safety climate values plotted over time. This element effectively provided the participant with a safety climate survey following every accident. No attempt was made to justify the output from a quantitative perspective. Indeed, the whole point was to provide participants with a qualitative perspective on which aspects of their company’s safety climate needed attention.

DATA INCORPORATED INTO THE MODEL

In order to model 5 years operations of an oil company of c. 1000 staff and 11 subcontractor companies, over 250,000 data items were created and implemented. This data was available in a total of 54 pages which comprised the 14 elements of the

model and which could be accessed on the relevant data screen of the video wall presentation.

A complementary, fully functional email system was developed. This email system was pre-loaded with over 200 accidents as well as over 50 emails on various safety topics that any senior manager might be expected to encounter in his professional life. These also included requests from the Chairman of the Board for information and explanation. All emails were programmed to be delivered to the participant's inbox at the appropriate time during the session. It was possible for the participants to respond to emails and all responses, were sent to the trainer's inbox. If a further response was required then one could be sent purporting to come from the original recipient. Email discourse was discouraged due to the rapid progression of simulated time which always overtook the need for protracted discussion / debate.

EVALUATION & CONCLUSION

Evaluation of the learning environment was carried out using volunteers from a diverse range of industrial management backgrounds and experience levels ranging from junior management up to board member level. This included both senior and junior representatives from the health and safety professions as well as energy and non-energy related organisations.

The evaluation generated over 136 hours of audio/video material (8+ hours / participant) documenting the participant's interaction with the individual components of the data screens as well as hundreds of written communications in the form of e-mail traffic. A full analysis of the results of the evaluation is therefore well beyond the scope of this paper however, an example from one component of the evaluation is provided. During the session, each participant was required to produce an annual report to the "board of directors" for each of the 5 years incorporated into the SCLE on their analysis of their company's safety culture. Using a pre-defined marking template, each of these reports was evaluated in terms of how well the participants had understood and described their organisation's safety culture for that year and scored accordingly. Participants were classified into three groups – HSE professionals, finance professionals and general industry management professionals. When the scores for each group were combined and compared, there is a clear upward trend in all three cases (Figure 2). Interestingly, while the HSE professionals began at a higher point as might be expected, all three groups arrived at around the same level at the end of the 5 years.

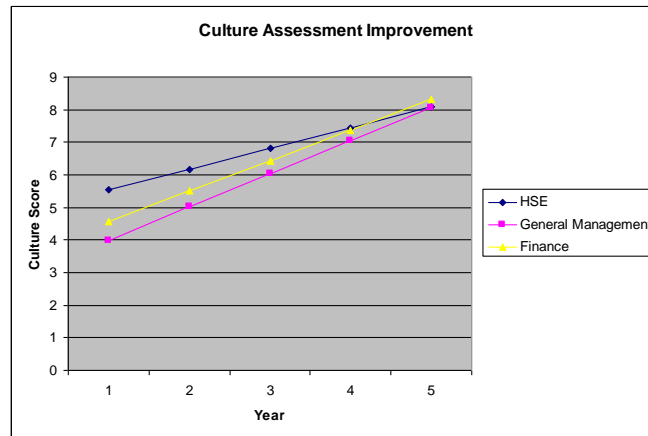

Figure 2. Group Culture Assessment Improvement

Finally, in addition to evaluating performance through video wall analysis, report content and pre- and post- training interviews, participants were simply asked for their impressions of the tool as an appropriate safety culture education tool. Without exception, they found the experience intense, challenging and at times extremely stressful. Examples of this feedback included –

- I spent a day in interaction with this training tool and it was one of the most useful and impressive days I have spent in recent years and one that every manager serious about his effect on HSE culture should experience. (C. Eng, FIEE)
- "This is not for the faint hearted. It is the most intensive and stressful training that I have ever undertaken, but I also learned more in the time than in any other situation". (F.I. Mech. E; Honorary Fellow of the Safety and Reliability Society)
- "I gained a depth of experience of safety leadership that is hard to find in anything but the real world". (Leadership Development Consultant)

In conclusion, a complex model of a functioning oil company, operating in a high risk environment, has been designed and implemented. A total of 17 participants have completed the training and the analysis of their performance shows that all exhibited improvement in their ability to evaluate their company's safety culture. Feedback indicates that the experience was extremely well received by both highly experienced safety professionals and line managers alike and has been particularly positive in terms of their opinions on the benefits of the SCLE in changing line management perceptions of corporate safety culture measurement, evaluation and understanding.

References

- BP (2011). Interview with Frank Bowman. BP Magazine, Retrieved from <http://www.bp.com/en/global/corporate/press/bp-magazine/issue-four-2011/interview-with-frank-bowman.html>
- BSI. (1999). OHSAS 18001, Occupational Health and Safety management systems. UK: British Standards Institute.

- Center for Chemicals Process Safety, (2011). Safety Culture. 'What is at stake' Available from http://www.aiche.org/uploadedFiles/CCPS/Resources/KnowledgeBase/Whats_at_stake_Rev1.pdf
- Cram, R S (2007). Revealing the Real Picture Behind Safety Performance Statistics. SPE Middle East Oil & Gas Show and Conference Bahrain.
- Cullen, The Hon. Lord W. Douglas (1990). The public inquiry into the Piper Alpha disaster. London: H.M. Stationery Office. ISBN 0101113102. 488 pages, 2 volumes
- Fennell, D. J. (2006). What it Takes to Make it Safe. Retrieved Jan. 2014, from <http://www.cssecalgary.com/200601.ppt>
- Fishwick, P (1995, September 21st). Computer Simulation: The Art and Science of Digital World Construction. Retrieved from <http://cise.ufl.edu/tr/DOC/REP-1995-179.pdf>
- Flin R and Mearns K and O'Connor P and Bryden R(2000). Measuring safety climate: identifying the common features. *Safety Science*, 34, 177-192.
- Friedman H and Amoo T (1999). Rating the rating scales. *Journal of Marketing Management* , Vol 9:3, 114-123.
- Glendon A I & Stanton, N A (2000) Perspectives on Safety Culture. *Safety Science* 34{1-3}, 193-214
- Guldenmund, F W (2000). The nature of Safety Culture: A review of theory and research. *Safety Science*, 34(1-3), 215-257
- Guldenmund, F W (2007). The use of questionnaires in safety culture research – an evaluation. *Safety Science* 45 (2007) , 723 – 743
- Hale A R (2000). Culture's confusions. *Safety Science*, 34(1-3) 1-14
- HSE. (2013). HSE Human Factors Briefing Note No. 7. Retrieved July 2013, from <http://www.hse.gov.uk/humanfactors/topics/07culture.pdf>
- Janis, I L and King, B T (1954). The influence of role playing on opinion change. *The Journal of Abnormal and Social Psychology*, 49(2), 211-218.
- Kitchenham, A (2008). The Evolution of John Mezirow's Transformative Learning Theory. 104 *Journal of Transformative Education*, 6(2), 104-123.
- Law, A M and & McComas, M G (2001). HOW TO BUILD VALID AND CREDIBLE SIMULATION MODELS. *IEEE Engineering Management Review*, 1, 22.
- Lord Kelvin (1883). Electrical Units of Measurement. PLA, Vol 1, Retrieved from <http://zapatopi.net/kelvin/quotes/>.
- Manuele, F A (2011). Reviewing Heinrich: Dislodging Two Myths From the Practice of Safety. *Professional Safety*, 52 - 61
- Thomas, R (2003). What Are Simulations? – The JeLSIM Perspective. Retrieved from <http://www.jelsim.org/resources/whataresimulations.pdf>.

A REAL TIME APPROACH TO MEASURING CORPORATE SAFETY CLIMATE

Robert S. Cram and Julie-Ann Sime

³Robert S. Cram 1 Department of Educational Research, Lancaster University, Bailrigg, Lancaster LA1 4YW, UK

²Julie-Ann Sime 2 Department of Educational Research, Lancaster University, Bailrigg, Lancaster LA1 4YW, UK

With potentially billions of dollars at stake as the price of poor HSE Performance, companies can no longer afford not to understand their underlying safety climate. If the shortcomings of current safety climate surveys render their use inappropriate, then a different approach to understanding corporate safety climate is essential.

Typically, safety climate is evaluated using questionnaires which are sent to a sample group within the organisation. Various analysis techniques are then used in an attempt to identify the prevalent safety climate. It has become increasingly apparent to a number of authors over the last few years that this approach is unlikely to provide the desired level of useful output.

A variety of factors combine to render the results of a conventional safety climate survey doubtful at best and misleading at worst. Principally, these relate to Question Ordering, Culture, Language, Rating Scales, Bias and Sample Selection. Any or all of which have the potential to impact the validity of the survey questionnaire approach in determining an accurate overview of prevalent safety climate.

This paper discusses an alternative approach to identifying safety climate on a continuous basis. While the technique was developed as a standalone module within a training tool designed around an operating oil company, it is equally applicable to any organisation operating in a high safety risk environment. By evaluating the impact of prevalent safety climate on accident causation, the approach produces indicators to safety climate deficiencies which management can address in order to improve overall safety climate.

Keywords: safety, climate, culture, evaluation, management.

INTRODUCTION

Wiegmann et al., (2002, p8) in their synthesis of safety climate and safety culture defined safety culture as –

“the enduring value and priority placed on worker and public safety by everyone in every group at every level of an organization. It refers to the extent to which individuals and groups will commit to personal responsibility for safety, act to preserve, enhance and communicate safety concerns, strive to actively learn, adapt and modify (both individual and organizational) behavior based on lessons learned from mistakes, and be rewarded in a manner consistent with these values”.

They go on to define safety climate (p10) as –

³ r.cram@lancaster.ac.uk

“the temporal state measure of safety culture, subject to commonalities among individual perceptions of the organization. It is therefore situationally based, refers to the perceived state of safety at a particular place at a particular time, is relatively unstable, and subject to change depending on the features of the current environment or prevailing conditions”.

The approach to continuously measuring safety climate described here was developed as a single element of a Safety Culture Learning Environment (SCLE) being developed at Lancaster University as part of the first author's PhD to teach management how to effectively measure and understand the overall safety culture of their organisations. The technique was designed around the Offshore Safety Climate Assessment Tool developed by Loughborough University (Loughborough 2000) in partnership with the UK Health & Safety Executive. Despite having been designed to fulfil the role of a single element within a 14 element teaching tool, this approach can also be used as a “stand alone” technique for evaluating safety climate in any type of organisation operating in a high risk environment.

HISTORICAL APPROACH TO MEASURING SAFETY CLIMATE

The most common method of assessing safety climate to date has been through the use of climate surveys (Williamson et al. 1997; Havold et al. 2001; Fernandez-Muniz et al. 2009). However, there is an abundance of research which suggests that this approach is flawed (Flin et al. 2000; Hale 2000; Guldenmund 2000 & 2007; Glendon and Stanton 2000). All have highlighted areas of significant concern with regard to the validity of the traditional survey approach.

Another key deficiency in the use of climate surveys is the time factor. A survey involves a great deal of time, effort and cost and at best provides only a snapshot of the safety climate of the organisation on the day the survey was conducted. All organisations are by their very nature fluid. They comprise numerous “informal networks” (Bourne 2002), which form and dissolve on a continuous basis in order that the organisation can conduct its daily activities. These networks, composed of members of the workforce, play a major role in the culture of the organisation. Their inherent instability therefore affects the overall safety culture of the organisation, thus rendering the snapshot climate survey effectively useless beyond the immediate time frame in which it was conducted.

There is a case to be argued that deriving “culture based initiatives” based on a single static safety climate survey of an organisation might in fact be counter productive. The very fluidity of the typical organisation means that it is highly likely that the original initiatives will not be applicable to the continuously evolving entity. Short of running multiple surveys over extended time periods, an expensive and disruptive process, there is currently no realistic way to continuously evaluate the effect of proactive measures on organisational safety culture.

Industry is therefore faced with a conundrum. On the one hand, safety culture is a major component in the ongoing drive towards a zero accident environment, yet major deficiencies exist in the validity of the existing techniques of safety culture evaluation and little, if anything, is available to educate and train management to measure and understand safety culture in their organisations. Glendon and Stanton (2000 p4) state –

“If organisational culture, or some aspect of it, is to be measured, then complex and imaginative methods of assessment and analysis will be required. Questionnaires or similar measures will be inadequate to measure all aspects of organisational culture”.

SAFETY CLIMATE QUESTIONNAIRES

A variety of factors combine to render the results of a safety climate survey doubtful at best and misleading at worst. Principally, these relate to Question Ordering (Schuman and Ludwig 1983; Hayman and Sheatsley 1950), Culture/Language (Tellis and Chandrasekaran 2010; Dolnicar and Grun 2007; Perez 2011); Rating Scales, (Friedman and Amoo 1999), Bias (Friedman and Amoo 1999), Survey Population (Fernandez-Muniz, et al. 2009). All have the potential to impact the validity of the typical survey questionnaire approach to identifying safety climate.

Question Ordering

Schuman and Ludwig (1983) examined work on the issues surrounding the ordering of questions. They refer to the Rugg and Cantrill experiment* (Rugg and Cantrill 1944) where respondees were asked two questions. The responses differed greatly, depending on the order in which the questions were put.

Table 1. Response to questions depending on order (Rugg and Cantrill 1944)

	Position		Difference
	1st	2nd	
Should the United States permit its citizens to join the French and British Armies?	49%	43%	-6%
Should the United States permit its citizens to join the German Army?	23%	34%	11%

* Numbers on which percentages were based were not reported.

In a similar study (Hayman and Sheatsley 1950) several hundred people (numbers in brackets below) were asked the questions in Table 2 below. Once again the responses exhibited large differences in the positive response rates depending on the question order.

Table 2. Response to questions depending on order (Hayman and Sheatsley 1950)

	Position		Difference
	1st	2nd	
Do you think a communist country like Russia should let American newspaper reporters come in and send back to America the news as they see it?	90% (635)	66% (567)	-24%
Do you think that the United States should let Communist newspaper reporters from other countries come in here and send back to their papers the news as they see it?”	36% (581)	73% (635)	37%

The impact of question ordering has major implications in the design and analysis of any questionnaire, especially where the topic is as emotive as safety. Safety climate surveys are expensive and time consuming for any organisation, so testing the effect of question order on the population prior to conducting the final survey is impractical. The idea of submitting an already potentially highly biased questionnaire in an attempt

to elicit useful insights regarding an organisation's climate is a highly risky venture at best.

Culture/Language

In a study of over 5,500 respondents across 15 countries, Tellis and Chandrasekaran (2010) established that different countries exhibited "substantial" differences in responses to the same question sets. While their work was not based on safety culture/climate per se, it is supported by other research, all of which combine to reinforce the idea that culture and language play a significant role in affecting survey participants' responses. Dolnicar and Grun (2007, p5) observe –

"Cross-cultural studies are in danger [of] drawing wrong conclusions from empirical data if respondents from different cultural backgrounds are included who demonstrate systematically different response patterns which are not content-related".

While the simple solution to multi-cultural/multi-lingual survey issues may appear to translate the survey into the respondees' language(s), Perez (2011, p448) cautioned against *"assuming the cross-language portability of survey items"*.

Rating Scales

A common type of question in a typical safety climate survey provides responses such as "Excellent, Very Good, Good, Fair and Poor" (Likert Scales). This type of response is open to intentional or unintentional abuse. Friedman and Amoo (1999) examined the difficulties inherent in research based on rating scales. The authors illustrate the scope for biasing any survey conducted by rating scales. Pollack et al. (1990) found that scales whose anchor points include strong adjectives such as "Superior" or "Terrible" do not produce the same results as scales with weaker end points such as "Very Good" and "Very Bad". Respondents seem to be reluctant to select extreme values.

Numerical scales are not immune either. Schwartz et al. (1991) showed that the question "How successful would you say that you have been in life?" when asked of 1032 respondents, elicited very varied responses. When the scale was from 0 (not at all successful) to 10 (extremely successful), 36 per cent were in the range 0 to 5 and when the scale was from -5 to 5 only 13 per cent were in the range -5 to 0. Even with the same verbal descriptors in both scale instances, the responses were dominated by the numerical values of the scales.

Bias

Friedman and Amoo (1999) state that forced-choice rating scales affect the bias of a questionnaire by obliging respondents to actually have an opinion. By omitting the "No opinion" option, the researcher is making the assumption that every respondent has a valid and valued opinion on the particular topic. This is not necessarily correct and can lead to bias in the data. This, according to Friedman and Amoo (1999), has the dual effect of forcing the mean and the median of responses to the middle, since many unopinionated respondents will tend to go for the median "average" or "fair" values. Additionally it will make it appear that more respondents have an opinion on the particular question topic than may actually be the case.

Survey Population

Identifying the most appropriate survey population is fraught with difficulty. In their paper on "Relation between occupational safety management and firm performance",

Fernandez-Muniz et al. (2009) selected the Safety Officer as being the person who could be -

“expected to have most information about the safety practices and procedures that are being carried out within the firm and be familiar with the difficulties involved in implementing the [safety management] system”.

Fernandez-Muniz et al. (2009) believed that the safety officer’s opinion would be “less biased and more accurate”. It is possible, if not likely, that this assumption may in itself have significantly influenced the results of their survey. Safety professionals are the only people in the organisation who are paid to be committed to safety. It is not unreasonable to assume that other members of the workforce hold a completely different view of safety and its management. By selecting a single occupational post with a possible high degree of bias, the results were unlikely to reflect the views of the whole organisation.

SAFETY CLIMATE FEATURES

In their review into common features Flin et al. (2000) identified 18 safety climate surveys which, on review, revealed a high degree of commonality in areas such as management, safety systems and risk, with competence and work pressure appearing frequently as well. Williamson et al. (1997), in a review of the literature, identified eight factors common across multiple safety climate studies.

What is common to many such reviews is the high degree of correlation between the categories/themes/factors within safety climate questionnaires and the elements identified in Health and Safety Management Systems (HSMS) such as OHSAS 18001. (BSI 1999).

Table 3 presents the principal elements to be found in a typical OHSAS 18001 based HSMS.

Table 3: OHSAS 18001 Management System Elements

Policy	Operational Control	Awareness
Strategy	Emergency Preparedness & Response	Training
Risk & Hazard Assessment	Contractor Eval, Qualif. & Selection	Consultation & Communication
Prevention & Mitigation	Contractor Management	Documentation
Legal & Other Requirements	Contractor Performance	Document & Data Control
Objectives	Performance measurement & monitoring	Lessons Learned
Line Management	Accident reporting	Audit
Individuals	Records & Record Management	Results
HSE Function	HSE MS Review	Actions
Competence	Self-Assessment	

Table 4 presents a summary of the common categories described by Flin et al. in their review of 18 different safety climate studies.

Table 4: Summary of Categories (Flin et al. 2000)

Accident reporting	Organisational	Safety committee
Activities	Participation	Safety level
Attitudes to safety	People	Safety policy
Blame	Permit to work	Safety reps
Commitment	Personal immunity	Safety systems
Communication	Personal motivation	Safety/production

Competence	Personal scepticism	Speaking up
Control of safety	Positive safe practice	Supervisor
Design	Prevention strategies	Teamwork
Excellence, honesty	Procedures	Training
Fatalism/optimism	Production as priority	Violations
Group attitudes	Productivity/safety	Work clarity
Individual responsibility	Promotion	Work conditions
Job satisfaction	Risk	Work environment
Job stress	Risk perception	Workplace
Knowledge	Risk taking	Work practices
Management	Rules/regulations	Work pressure
Need for safety	Safety arrangements	Work value
Obstacles to safety	Safety as priority	Worker involvement
Openness	Safety awareness	

It is apparent that there is a high level of overlap between the two. This obliges the question

“If there is such close correlation between the elements of the typical OHSAS 18001 HSMS and the typical safety climate survey, why is it necessary or desirable to create safety climate questionnaires which are not directly linked to the elements of the HSMS most likely already in place within the organisation being surveyed?”

RELATIONSHIP BETWEEN SAFETY CLIMATE AND ACCIDENT OCCURRENCE

John Quast (2004, p22) is quoted as saying:

“You can talk about systems and procedures and you can have all of that in place but if people don’t follow them or [they] have a supervisor that is not behaving as an HSE leader then you don’t have a good HSE culture”, to which he added, “accidents would continue to occur due to a poor HSE Culture despite the fact that a company had good safety procedures and standards in place”

Before him, James Reason (2000, p3) stated

“..... only a safe culture can provide any degree of lasting protection”

If such observations are correct then it follows that an organisation with a perfect safety culture should expect to have achieved the goal of a zero accident operation. Conversely, organisations with a poor safety culture should anticipate accident incidence on a frequency which might be expected to have some relationship to the quality of organisational safety culture. A conclusion which can be drawn therefore is that, underlying accident root causes, is a deeper level requiring investigation; that of deficiencies in one or more aspects of an organisation's safety culture.

Furthermore, if safety climate is a *“temporal state measure of safety culture”* as proposed by Wiegmann et al., (2002) then the word climate can be substituted for culture in the above conclusion for a particular point in time. It is further proposed that an optimum point at which to evaluate deficiencies in the instantaneous state of organisational safety climate is at the time of an accident.

In most companies committed to improving safety performance, a process of accident investigation will be in place. Typically, this involves some form of root cause analysis (RCA) where investigators seek to move beyond the immediate causes and uncover the underlying or root causes which have contributed to the event. The next

investigation level down looks at which elements of the Safety Management System failed in order for the accident to have taken place. Proceeding even deeper into organisational influence, (Figure 1), a Climate Deficiency Analysis (CDA) can be used to identify where deficiencies exist in organisational safety climate which permit HSMS failures.



Figure 1. Level of investigation

MAPPING SAFETY CLIMATE TO THE HEALTH AND SAFETY MANAGEMENT SYSTEM

Many different safety climate surveys exist. For the purpose of developing the safety climate module of the teaching tool, questions selected were mostly taken from the work done by Loughborough University and the UK Health and Safety Executive (Loughborough 2000). These were divided into similar categories as those identified by Cox and Cheyne, (2000) though the number of categories was reduced to the following list simplify the module for the trainees.

- Management commitment
- Priority of safety
- Communication
- Safety rules
- Supportive environment
- Involvement
- Personal priorities and need for safety

As part of the SCLE development for which this continuous safety climate evaluation technique was developed, a typical OHSAS 18001 based HSMS was produced for trainees to use as their fictitious organisation's HSMS. The questions from the Loughborough safety climate measurement toolkit were then mapped onto the elements of the SCLE HSMS.

Note for clarity. As this technique was created for a learning environment which simulated an oil company operating over a 5 year period, an accident database had already been constructed containing over 200 real accidents which would "happen" over the 8hr training session.

All of these accidents had been analysed in advance for root causes, management system deficiencies and safety climate deficiencies. This information was then displayed to the trainees during the 8hr simulation that the teaching tool took to simulate 5 years worth of company operations. In reality, every time an accident takes

place, exactly the same technique can be applied and the results incorporated into the ongoing climate analysis for the organisation in question.

CLIMATE DEFICIENCY ANALYSIS AND PRESENTATION OF RESULTS

Having identified the HSMS failures for each and every accident in the database and with the safety climate questionnaire to HSMS mapping in place, it was then a relatively straightforward process to score each climate survey question that was mapped to an HSMS element that had been identified as deficient in enabling each accident to occur. When every HSMS deficiency had been identified and each mapped survey question scored, the totals for each of the climate survey elements could be calculated.

An important distinction between the traditional discrete approach to safety climate evaluation and this approach is that traditional questionnaire methods generally seek to quantify the magnitude of each of the climate components. The approach adopted here was based on work carried out on the use of neural networks to analyse accident data (Cram 2004). In this approach, less importance is placed on attempting to evaluate the precise magnitude of individual criteria and more emphasis is directed towards identifying the relative magnitudes of influence that each component may have on existing safety climate. In the industrial environment for which this approach was designed, all that hard pressed managers really want to know is where to focus their attention to get the best result for their efforts. By combining the scores generated by each accident over a rolling 90 day average, it was then possible to present the participants with “real-time” plots of the criteria most influencing current safety climate.

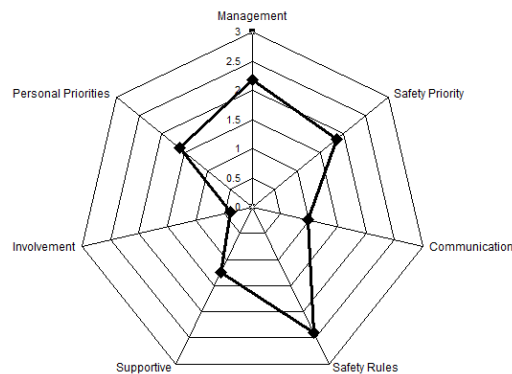

Figure 2. Radar plot of instantaneous safety climate elements

Two plots were produced. The first (Figure 2) presented the results in the same radar plot presentation style used by Cox and Cheyne (2000).

A metric referred to as the Safety Climate Index was produced by calculating the area of the radar plot bounded by the seven elements of the Climate Deficiency Analysis. This provided participants with a simple numerical indicator to identify whether safety climate had improved or worsened over the preceding time period. The lower this number, the more improved the overall safety climate of the organisation.

Figure 3 presents the same individual safety climate elements in the form of a simple line chart illustrating safety climate element changes over time. This was particularly useful for the participants as it enabled them to see real change over time in various aspects of their organisation's safety climate and for them to link this information with the other 13 modules in the SCLE in order to derive a clearer picture of the prevalent overall safety culture with their operations.

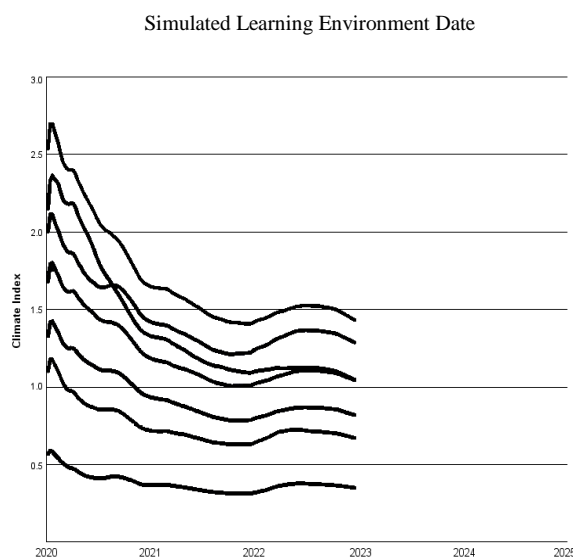

Figure 3. Safety Climate Index by Element

DISCUSSION AND CONCLUSIONS

The SCLE has been evaluated by a representative sample of 17 managers from a diverse variety of industries who participated in an 8 hour management training session. Initial analysis of the data suggests that the incorporation of the Continuous Safety Climate module into the Safety Culture Learning Environment has been a powerful and useful addition to the safety culture “picture” which participants were striving to visualise, interpret and understand. In contrast to conventional discrete safety climate surveys which provide only a single “snapshot” of the current climate situation, presenting participants with an extended view of how the organisation is changing over time provides a greater contribution to the goal of improving their ability to “read” the overall safety culture of the entity over which they exercised considerable influence.

Most significant is the opportunity to see at a glance the different rates of change of the various elements of the safety climate model. When required to report to the “board of directors” at the end of each simulated “year”, these trends provided a valuable contribution to the participants’ understanding of the ongoing status of their organisation’s overall safety culture.

Knowledge that such information is available will provide senior management with greater insight into what can be achieved with access to the right data.

For the purpose of the design and development of the SCLE, the questions used in the mapping to the management system were generally based on the work by Loughborough University and the UK HSE however, there is no reason why different

question sets can not be similarly mapped, where applicable, to the corporate HSMS should different types of climate surveys be required.

REFERENCES

- Bourne, D (2002) Informal Networks. Retrieved January 2012, from http://www.magustoolbox.com/html/informal_networks.html
- BSI. (1999). OHSAS 18001, Occupational Health and Safety management systems. UK: British Standards Institute.
- Cram, RS (2004) SPE 86735-MS - Improving the implementation of HSE Management Systems through the use of Neural Networks to analyse accident data. SPE International Conference on Health, Safety, and Environment. 29-31 March, Calgary, Alberta, Canada.
- Cox, SJ and Cheyne, AJT (2000) Assessing safety culture in offshore environments. *Safety Science*. 34 pp.111-129
- Dolnicar, S and Grun, B (2007). "Cross-cultural differences in survey response patterns", *International Marketing Review*, Vol. 24 Iss: 2, pp.127 - 143
- Fernandez-Muniz, B and Montes-Peon, JM and Vazquez-Ordas, CJ (2009) Relation between occupational safety management and firm performance. *Safety Science*, 47, pp. 980-991
- Flin, R and Mearns, K and O'Connor, P and Bryden, R (2000) Measuring safety climate: identifying the common features. *Safety Science*, 34, pp.177-192
- Friedman H and Amoo T (1999) Rating the rating scales. *Journal of Marketing Management*, Vol 9:3, pp.114-123.
- Glendon A.I. and Stanton, N.A. (2000) Perspectives on Safety culture. *Safety Science* 34{1-3), 193-214
- Guldenmund, FW (2000) The nature of safety culture : A review of theory and research. *Safety Science*, 34(1-3), pp. 215-257
- Guldenmund, FW (2007) The use of questionnaires in safety culture research – an evaluation. *Safety Science* 45 , pp.723-743
- Hale, AR (2000) Culture's confusions. *Safety Science*, 34(1-3) pp. 1-14
- Havold, JI and Nettet, E and Strand, O. (2001) Safety Attitudes and Safety Ambivalence among officers from the Philippines and Norway. *Safety Science Monitor*, 15(1), Article 2.
- Hayman, HH and Sheatsley, PB (1950) The current status of American public opinion. In J. C. Payne (Ed.), *The teaching of contemporary affairs* (pp. 11-34). Washington D.C., USA: National Council for the Social Studies.
- Loughborough University (2000) Safety Climate Measurement User Guide and Toolkit. <http://www.lboro.ac.uk/media/wwwlboroacuk/content/sbe/downloads/Offshore%20Safety%20Climate%20Assessment.pdf>
- Perez, EO (2011). The Origins and Implications of Language Effects in Multilingual Surveys: A MIMIC Approach with Application to Latino Political Attitudes. *Political Analysis* 19 (4): 434-454
- Pollack, S and Friedman, HH and Presby, L (1990) "Two Salient Factors in the Construction of Rating Scales: Strength and Direction of Anchoring Adjectives," *International Conference of Measurement Errors in Surveys*. Tucson, Arizona, November 11-14, p. 57.

- Quast, J (2004). HSE culture is another step to reach zero incidents. *Drilling Contractor*, 22-25
- Reason, J (2000) Safety paradoxes and safety culture. *Injury control & safety promotion*. 7(1), pp3-14.
- Rugg, D and Cantril, H (1944) The wording of questions. In H. Cantril (Ed.), *Gauging Public Opinion* (pp. 2-50). Princeton, USA: Princeton University Press.
- Tellis, G.J. and Chandrasekaran, D. (2010). Does Culture Matter? Assessing Response Biases in Cross-National Survey Research. *International Journal of Research in Marketing*.
- Schuman, H and Ludwig, J (1983) The norm of even-handedness in surveys as in life. *American Sociological Review*, 48, pp. 112-120.
- Schwartz, N and Barbel, K and Hipler, HJ and Noelle-Neumann, E and Clark, L (1991) Numeric Values May Change the Meaning of Scale Labels. *Public Opinion Quarterly*, 55:4, pp. 570-582
- Wiegmann, D.A. and Zhang, H. and von Thaden, T. and Sharma, G. and Mitchell, A. (2002). *A Synthesis of Safety Culture and Safety Climate Research*. Technical Report ARL-02-3/FAA-02-2. Savoy, Illinois.
- Williamson A. M. and Feyer A. and Cairns D. and Biancotti D. (1997). The development of a measure of safety climate: The roles of safety perceptions and attitudes. *Safety Science*, 25(1-3), 15-27.

THE ROLE OF SIMULATION-BASED LEARNING IN THE OCCUPATIONAL HEALTH TRAINING OF YOUNGER CONSTRUCTION WORKERS

Nyateka N⁴, Gibb A. G. F, Dainty A. R. J¹, Bust P. D¹ and Cook S²

¹ *School of Civil & Building Engineering, Loughborough University, Loughborough, LE113TU, UK*

² *Loughborough Design School, Loughborough University, Loughborough, LE11 3TU, UK*

Occupational ill-health statistics have consistently placed construction as a high risk industry. Younger workers (aged 15-24) constituting 24% of the construction workforce are more exposed to physical work factors including noise, vibrations and the handling of dangerous substances. The provision of effective training is crucial in preventing occupational illnesses among younger workers and increases their chances to become healthy older workers. However, whilst the delivery of training in other professions such as healthcare and aviation has rapidly been shifting toward pedagogy rich in hands-on/experiential learning, training in the construction industry has not taken full advantage of new innovative training approaches. This paper discusses the pedagogical foundations and effects of one such approach - simulation-based training, on the basis of a review of literature, including relevant examples and a case study. It discusses the potential benefits of adopting simulation-based learning in the occupational health training of younger construction workers over more traditional approaches. Additionally, the paper presents innovative wearable simulations which have been developed previously by Loughborough University, and the rationale for adapting these as training tools in on-going research. The review concludes that learner-centred participatory approaches have the potential to increase knowledge, awareness and understanding as well as enhance learner experience, hence the ability to improve occupational health for younger workers. Training providers must move from traditional didactic methods to include a wider range of progressive methods and greater use of experiential learning.

Keywords: construction, occupational ill-health, simulation-based learning, training, younger workers.

INTRODUCTION

The problem

Occupational illnesses are a significant problem for the construction industry. In the UK, in 2011/2012, the Labour Force Survey estimated that 74 000 people whose current or most recent job in the previous year was in construction, suffered from an illness (longstanding and new cases) which was caused or made worse by their current job (HSE 2013). A total of 1.7 million working days or 0.87 days per worker in 2011/2012 were lost due to self-reported work related illness (HSE 2013). In addition, HSE have published figures that show that the industry significantly exceeds the all-industry incidence rates with respect to musculoskeletal disorders, occupational

⁴ N.Nyateka@lboro.ac.uk

dermatitis, work related hearing loss, mesothelioma and asbestosis, with vibration related disorders only being surpassed by the extractive industries (HSE 2013).

Presenting further challenges to the industry are the changes in demographics and in education and training arrangements, which are resulting in greater numbers of younger people (age 15-24) entering work (For example, the Young Apprentice Programme in the UK provides a construction qualification for 14-16 year old learners, and includes up to 40 days of work experience over the two year period). According to the European Statistics on Accidents at Work (ESAW) (2007), young workers are more exposed to physical work factors including noise, vibrations, heat or cold and the handling of dangerous substances.

The economic and human costs related to occupational illnesses are substantial. For example, sickness absence costs the UK economy an estimated £12 billion (~€14.5bn) per annum (HSE 2013). It is therefore imperative that the occupational health of workers is taken seriously and properly managed. Protecting the health of younger workers is critical to the construction industry's sustainability, its long term economic performance and also of great importance for young people themselves, for their overall management of life, health and well-being.

Worker training

Training is a fundamental requirement for preventing occupational illnesses and improving the industry's occupational health performance. The provision of training by employers is an explicit requirement of the UK's Health & Safety legislation. Under the Health and Safety at Work (etc.) Act, 1974, for example, employers have a legal obligation to provide information, instruction, training and supervision as is necessary to ensure the health and safety at work of employees. Numerous authors also acknowledge the importance of training in establishing a healthy working environment (Dufficy 2001, Loosemore et al. 2003, Wallen and Mulloy 2006, Linker et al. 2005, Mowlam et al. 2010, Burke et al. 2006). Inadequate, or lack of, occupational health training has been identified as an important contributing factor to the high incidence rates within the industry (Tam and Fung 2011, Guo et al. 2012, Wallen and Mulloy 2006).

An understanding of how best to implement appropriate and effective worker health training is urgently needed. This is because much conventional learning theory, including that in most training courses, tends to endorse the valuation of abstract knowledge over actual practice and relies heavily on traditional trainer-centred approaches to learning. Workers are typically sat down in a classroom-like setting and spoken to by "experts" with the support of slides, booklets and videos. They are then expected to apply this abstracted knowledge later in the workplace (Gherardi and Nicolini 2002).

The effectiveness of these trainer-centred/information-based approaches in maximising trainees' learning is increasingly questioned. Limitations include failure to actively engage learners; the emphasis on auditory learning as opposed to other learning styles such as visual or kinaesthetic learning; the assumption that all trainees learn at the same pace and have similar levels of understanding; and the risk of information loss due to their passive nature (Piercy et al. 2012). Social learning theorists reject transfer models, which isolate knowledge from practice, and develop a view of learning as social construction, putting knowledge back into the contexts in which it has meaning (Lave and Wenger 1991). From this perspective, learners are

seen as social beings that construct their understanding and learn from social interaction within specific socio-cultural settings (Lave and Wenger 1991, Gherardi and Nicolini 2002). Gherardi and Nicolini (2002) emphasize the importance of learning in non-instructional settings, suggesting that learning a practice is an eminently situated activity based on the combined use of language, action and observation.

A growing body of educational thought has emphasised the socially situated nature of knowledge and particularly the role that activity, participation and experience play in learning (Li et al. 2007, Pasin and Giroux 2011, White 2010 Goedert et al. 2011, Abdulwahed and Nagy 2009). There has been a notable increase in the use of experiential training methods, albeit in non-construction industry contexts (Piercy et al. 2012, Mawdesley et al. 2011, Deshpande and Huang 2009, Li et al. 2007). Experiential learning may be defined as “the process whereby knowledge is created through the transformation of experience” (Kolb 1984). Learning by doing is the key concept that distinguishes experiential learning approaches from passive techniques, such as traditional classroom based lectures. Examples include simulations, role-plays, laboratories, fieldwork and live cases (Piercy et al. 2012, Hawk and Shah 2007).

Whilst contextually rich interactive simulations have proven effective at improving the educational experience in fields like the healthcare industry (McCaughey and Traynor 2010, Sinclair and Ferguson 2009), there is a paucity of work assessing the value of experiential training methods within the construction learning literature. Recent literature however, highlights the need to embrace new ways of learning and new ways of actively engaging the learner within the field of construction and engineering management (DeshPande and Huang 2009, Goedert et al. 2011, Mawdesley et al. 2011, Abdulwahed and Nagy 2009). These authors recognise the recent shift from traditional lecture-based training towards constructivist pedagogy in which the importance of knowledge gained via experience is emphasised. Goedert et al. (2011) argue that simulation-based learning addresses the fundamental need to reinvigorate instructional methods and approaches in construction education, which “have changed little in over a century”.

Research aim and methodology

The aim of this paper is to explore the possible role of an experiential learning method - simulation-based learning in the occupational health training of younger construction workers. An extensive review of relevant literature was conducted to give a clear understanding of the role that a simulation-based approach to younger workers’ training can play in enhancing their occupational health. The paper combines theoretical propositions with research examples and an illustrative case study to explore the impact and relevance of such an approach to learning.

LITERATURE REVIEW

Theoretical considerations

Learning styles

The last three decades have seen the emergence of numerous learning styles and or learning models that advance the idea that students learn in diverse ways and that individuals have a preference for receiving and storing information, for example, using pictures instead of text or learning by doing rather than reading or listening (Dunn 1990, Pritchard 2005, Coffield et al. 2004, Duff 2004, Hawk and Shah 2007,

Kolb 1984, Honey and Mumford 1992). These authors, amongst numerous others, offer descriptive typologies that range from relatively fixed student natural dispositions to modifiable preferences for learning. For example, Dunn (1990) argues that learners who are high achievers may strongly prefer one modality more than another, but often they have two or more preferences and can learn easily through one or the other. In contrast, underachievers may have either no preference or only one – usually tactile or kinaesthetic (Dunn 1990). For another learning theorist, Kolb (1984), a learning style is not a fixed trait, but a differential preference for learning, which changes slightly from situation to situation. Coffield et al. (2004) provide a comprehensive review of literature on learning styles and an examination of the most influential models.

The logic and appeal of learning styles is that training can be matched to the learning style preferences of particular learners, enabling them to learn better (Mowlam et al. 2010, Chen et al. 2011). However, if trainers assume that all trainees learn the same way or that one training approach will connect with all learners, they are likely to reach only some of the learners. Chen et al. (2011) stipulate that learners engage in the learning activities when the designed learning activities match with their preferred learning style. Thus, a lack of consideration of individual learners' different characteristics has the potential for ineffective engagement in the learning process. As Mowlam et al. (2010) suggest, a varied approach to training, that takes into account the diversity of learning styles as well as the different methods in which varied information needs to be communicated, is likely to achieve more effective learning. Wilkins (2011) notes the "literacy deficit" that exists among construction workers and also argues that the demographics and diversity of the construction industry workforce, including age, experience, culture, educational attainment and levels of literacy, have to be considered when developing training programs.

Younger workers' learning preferences

Some researchers have pointed out that the current generation of learners, having grown up surrounded by digital technology and in a social environment that is progressively interactive, think and process information fundamentally differently from their predecessors (DeshPande and Huang 2009, Li et al. 2007, Ueltschy 2001, Goedert et al. 2011). According to Deshpande and Huang (2009), this new generation of learners have a limited attention span, get bored of static media and have a more visual learning style. In order to maintain their interest, concentration level and motivation, a more stimulating learning experience is more suitable (Ueltschy 2001).

The work by Mowlam et al. (2010), who investigated the best ways of communicating health and safety messages to young learners in vocational education and training, supports these thoughts. The young learners in that study did not consider themselves to be big readers and found written information hard to engage with. Where written information was used, it was more effective when text was limited and pictures were included. Visually engaging material, practice and experience were considered more beneficial and easier learning routes than classroom teaching or written word (Mowlam et al. 2010).

In the case of learners coming from poorer and minority backgrounds, Kolb (1984: 6) argued that many of such learners “have not been rigorously socialised into the classroom/textbook way of learning but have developed their own distinctive approach to learning, sometimes characterised as “survival skills” or “street wisdom”.

For these, experiential learning methods offer an alternative way of learning, where students can capitalise on their practical strengths and actively engage in the learning process (Kolb 1984).

Simulations

Simulations represent an experiential approach to learning and may be defined as “representation of reality or some known process/phenomenon” (DeshPande and Huang 2009). The leading experiential learning theorist, Kolb (1984) was dissatisfied with traditional methods of teaching management students, which led him to experiment with techniques of learning from experience, drawing from the intellectual origins of experiential learning in the works of Dewey (1938), Lewin (1951) and Jean Piaget (1971). According to Kolb (1984), learning is a process whereby concepts are derived from and continuously modified by experience. During experiential learning, trainers purposefully engage learners in direct experience and direct their focus on learning reflection to increase their knowledge, skills and values (Dewey 1938). According to Dewey (1938), experience occurs as a result of interaction between human beings and the environment in forms of thinking, seeing, feeling, handling and doing. This experience may occur equally within a real or artificial environment.

The use of simulations as a method of teaching has received significant attention in the literature, with its original use in other professions such as the military, aviation and more recently healthcare industries (Mawdesley et al. 2011, Goedert et al. 2011, Deshpande and Huang 2009, Farrell 2005, Murphy et al. 2011, Sinclair and Ferguson 2009, McCaughey and Traynor 2010, Piercy et al. 2012). In healthcare for example, full scale integrated simulators combine life-like, anatomically correct manikins with computer programmes, permitting physiological and pharmacological responses such as respiratory and cardiovascular functions (McCaughy and Traynor 2010). These can be pre-programmed with a scenario to elicit a response, displayed on a clinical monitor, according to student intervention (McCaughy and Traynor 2010). Work has been done to evaluate the role of such simulations in students’ preparation for clinical practice (McCaughy and Traynor 2010). That study found simulations to be a valuable method of learning, which provides the link between theory and practice.

In other studies, researchers have examined the perceived effectiveness of simulations in teaching business courses (Farrell 2005, Li et al. 2007 and Piercy et al. 2012). The latter study presents a number of strengths of the experiential teaching method including the active engagement of students in their own learning, the stimulation of interest in the subject, the opportunity to learn how to work in often diverse groups, the acquisition of high order skills (teamwork, communication, conflict resolution, presentation, etc.), the application of theory to practice and the chance to try out ideas in a safe environment (Piercy et al. 2012). Similar benefits have been reported in other studies (DeshPande and Huang 2009, Farrell 2005, Li et al. 2007).

Simulation based learning therefore, offers a holistic integrative approach to learning, where ideas and knowledge are derived from and tested out in the experiences of the learner. Contemporary literature is largely supportive of the use of simulation-based learning methods (Mawdesley et al. 2011, Goedert et al. 2011, Deshpande and Huang 2009, Farrell 2005, Murphy et al. 2011, Sinclair and Ferguson 2009, McCaughey and Traynor 2010, Piercy et al. 2012), for the various benefits discussed above. However, the shift from traditional lecture-based training to learner-centred experiential learning methods, including simulations is evidently slow within construction. Goedert et al.

(2011), Wallen and Mulloy (2006) and Guo et al. (2012) are some of the few authors who have attempted to utilise new technologies such as simulations and visualisation in the industry's educational effort. There is a clear need for the industry to embrace new ways of learning, which have been shown to be effective in other industries.

The following section presents innovative wearable simulations, which have previously been developed by Loughborough University, UK. First, a case study from the transport sector is presented, to demonstrate the potential of wearable simulations in improving understanding of ageing and its impacts amongst young car designers. Second, wearable simulations of the occupational ill-health conditions affecting construction workers are presented.

LOUGHBOROUGH UNIVERSITY WEARABLE SIMULATIONS

A case study - Transport sector

Loughborough University has been active in the design and application of wearable simulations for 20 years. A whole body simulation suit, called the Third Age Suit ("Third Age" meaning older – typically 55+), shown in Figure 1, which simulates aspects of ageing was developed in 1994 for the Ford Motor Company as a mechanism for raising awareness within their predominantly young design team, of older driver characteristics and requirements.

THE THIRD AGE SUIT

The Third Age Suit "lets engineers slip into another generation, and feel for themselves what changes the body goes through that impact how a driver relates to a vehicle".

Fred Lupton, North American Program Ergonomics Supervisor
"This is a key training and awareness tool for us. Through the suit, our engineers can understand what it's like to be in the shoes of this demographic. decisions, therefore, become customer needs".

Eero Laansoo, Ergonomics Engineer

"When you are young and fit enough to leap out of a car without effort, it's hard to appreciate why an older person may need to lever themselves out of the driver's seat by pushing on the seat back and the door frame. But, try leaping out while you are wearing this Suit and you really understand the challenges we face".

Mike Bradly, Ergonomics Specialist in the UK



Our design
more in line with

Figure 1: Loughborough University whole-body simulation suit and evidence of awareness raising within The Ford Motor Company. Source (Cook et al. 2009)

Thus, the role of the simulations was to raise awareness (of a different population group), in order to promote behavioural change (improved designs). This was

achieved in the development of Ford's "trans-generational" vehicles (those which encompass the needs and aspirations of older and younger drivers). The cars incorporate "transparent-enablers" (unobtrusive features that meet varying needs), which are embodied in the Focus model in the form of high seats and wide-opening doors. Evidence of Ford's success in raising awareness is illustrated through their quotes provided in Figure 1.

LUSKInS

Loughborough University are currently involved in research into age-related occupational ill health within the construction industry, which has highlighted the critical need to target younger workers' attitudes towards occupational health in order to reduce problems in later life (Cook et al. 2009 and 2012). Wearable devices called LUSKInS (Loughborough University Sensory and Kinaesthetic Interactive Simulations) which simulate the key occupational ill-health conditions most prevalent within the construction industry (dermatitis, hand-arm vibration syndrome (HAVS), musculoskeletal disorders (MSDs), noise-induced hearing loss and respiratory disorders) and their consequential impacts on both working and home life have been developed (Cook et al. 2009 and 2012), shown in Figures 2-5.



Figure 2 LUSKInS Dermatitis Gloves (Visual and Tactile)



Figure 3 LUSKInS HAVS Gloves (Visual and Tactile)



Figure 4 LUSKInS Tinnitus and Occupational Asthma Simulations



Figure 5 LUSKInS MSD Simulations (Lower Back and Knee)

Next steps

Following this literature review paper, work is underway to use the LUSKInS as training tools. That work is being carried out in collaboration with a UK national training provider that provides vocational courses for new entrants/apprentices to the industry. A LUSKInS-based training programme is being developed, and will subsequently be integrated into the occupational health training sessions of the young learners. Following the Ford precedent, the rationale for using these simulations to train younger workers is that, when worn, the devices will raise awareness, by enabling the wearer to directly experience the difficulties, limitations and discomforts encountered by sufferers in the course of their daily tasks, and therefore encourage attitudinal and behavioural change to occupational health matters. The impact of the intervention will be assessed through observations of training sessions, interviews with participants and survey questionnaires.

CONCLUSIONS

The aim of this paper was to explore the potential role of simulation-based learning in the occupational health training of younger construction workers. The literature review reveals that simulation-based learning offers significant potential to enhance the learning experience. Benefits include the active engagement of students in their own learning, the stimulation of interest in the subject, increased awareness and comprehension of real world issues, the opportunity to learn how to work in diverse groups, the acquisition of high order skills as well as the provision of the link between theory and practice. The stated benefits demonstrate why construction industry trainers must consider simulation-based learning as a viable and effective alternative to the traditional didactic approaches, particularly when training younger workers, reported to prefer modern, interactive ways of learning. However, this does not suggest that experiential teaching methods should be seen as a direct replacement for traditional methods. Instead, they represent a complimentary, progressive method, which addresses the fundamental need to reinvigorate instructional methods in construction training.

REFERENCES

- Abdulwahed, M and Nagy, Z K (2009) Applying Kolb's experiential learning cycle for laboratory education. "Journal of Engineering Education", 98(3), 283-294.
- Burke M J, Sarpy S A, Smith-Crowe, K, Chan-Serafin, S, Salvador, R O and Islam, G (2006) Relative Effectiveness of Worker Safety and Health Training Methods. "American Journal of Public Health", 96(2), 315-324.
- Chen, N, Kinshuk, Chu-Wang and Chia-Chi (2011) Effects of matching teaching strategy to thinking style on learner's quality of reflection in an online learning environment. "Computers and Education", 56, 53-64.
- Coffield, F J, Moseley, D V, Hall, E and Ecclestone, K (2004) "Learning styles and pedagogy in post-16 learning: A systematic and critical review", London: Learning and Skills Research Centre.
- Cook, S, Richardson, J, Gibb, AGF and Bust, PD (2009) Raising awareness of the occupational health of older construction workers, "CIB W099 international conference", Melbourne, Australia, ISBN 978-1-921426-46-9, Abstract p. 37, ISBN 978-1-921426-47-6 Full paper – Health and Well-being stream, pp. 33-43.
- Cook, S, Gibb, AGF, Richardson, J, Walmsley, K and Bullock, D (2012) Loughborough SKInS: wearable simulations of Occupational Health – Defining specifications and product development. "CIB W099 international conference", Singapore.
- DeshPande, A A and Huang, S H (2011) Simulation games in engineering education: a state-of-the-art review. "Journal of Computer Applications in Engineering Education", 19, 399-410.
- Dewey, J (1938) "Experience and Education". Kappa Delta Pi.
- Duff, A (2004) Approaches to learning: The revised approaches to studying inventory. "Active learning in Higher Education", 5(1), 56-72.
- Dufficy, M (2001) Training for success in a new industrial world. "Industrial and commercial training", 33(2), 48-53.
- Dunn, R (1990) Understanding the Dunn and Dunn learning style model and the need for individual diagnosis and prescription. "Reading, Writing, and Learning Disabilities", 6, 223-247.
- European Agency for Safety and Health at Work (2007) "OSH in figures: Young workers - Facts and figures". European Agency for Safety and Health at Work.
- Farrell, C (2005) Perceived effectiveness of simulations in international business pedagogy: An exploratory analysis. "Journal of teaching in International Business", 16(3).
- Gherardi, S and Nicolini, D (2002) "Learning the Trade: A Culture of Safety in Practice". London, Sage Publications.
- Goedert, J, Cho, Y, Subramaniam, M Guo, H and Xiao, L (2011) A framework for Virtual Interactive Construction Education (VICE). "Automation in Construction", 20, 76-87.
- Guo, H, Heng, L, Chan, G and Skitmore, M (2012) Using game technologies to improve the safety of construction plant operations. "Accident Analysis and Prevention", 48, 204-213.
- Health and Safety Executive (2013) "Construction: Work related injuries and ill health". HSE. [Online]. Available from <http://www.hse.gov.uk/statistics/industry/construction/construction.pdf>

- Health and Safety Executive (2013) "HSE Statistics". [Online]. Available from:
www.hse.gov.uk/statistics
- Hawk, T F and Shah, A J (2007) Using learning style instruments to enhance student learning. "Decision Sciences Journal of Innovative Education", 5(1).
- Honey, P and Mumford, A (1992) "The manual of learning styles". Maidenhead, Peter Honey Publications.
- Kolb, D (1984) "Experiential learning: Experience as the source of learning and development". Englewood Cliffs, NJ, Prentice-Hall.
- Lave, J and Wenger, E (1991) "Situated learning. Legitimate Peripheral Participation". Cambridge, Cambridge University Press.
- Li, T, Barnett, A, Greenberg and Nicholls, J A F (2007) Teaching experiential learning: Adoption of an innovative course in an MBA marketing curriculum. "Journal of marketing education", 29(1), 25-33.
- Linker, D, Miller, M, Freeman, K, Burbacher, T (2005) Health and Safety awareness for working teens: developing a successful, state-wide program for educating teen workers. "Family Community Health", 28(3), pp. 225-238.
- Loosemore, M, Dainty, A and Lingard, H (2003) "Human Resource Management in Construction Projects: Strategic and operational approaches", London and New York: Spon Press.
- Mawdesley, M, Long, G, Al-jibouri, S and Scott, D (2011) The enhancement of simulation based learning exercises through formalised reflection, focus groups and group presentation. "Computers and Education", 56, 44-52.
- McCaughey, C S and Traynor, M K (2010) The role of simulation in nurse education. "Nurse education today", 30, 827-832.
- Mowlam, A, Mitchell, M, Jones, N and Ludford, H (2010) "How best to communicate health and safety messages to young learners in vocational education and training". London, HSE.
- Murphy, S, Hartigan, I, Walshe, N, Flynn, A V and O'Brien, S (2011) Merging problem-based learning and simulation as an innovative pedagogy in nurse education. "Clinical simulation in nursing", 7(4), 141-148.
- Pasin, F and Giroux, H (2011) The impact of a simulation game on operations management education. "Computers and Education", 57, 1240-1254.
- Piercy, N, Brandon-Jones, A, Brandon-Jones, E and Campbell, C (2012) Examining the effectiveness of experiential teaching methods in small and large OM modules. "International journal of operations & production management", 32(12), 1473-1492.
- Pritchard, A (2005) "Ways of learning: Learning theories and learning styles in the classroom". London, David Fulton Publishers.
- Sinclair, B and Ferguson, K (2009) Integrating simulated teaching/learning strategies in undergraduate nursing education. "International Journal of Nursing Education Scholarship", 6(1), 7-11.
- Tam, V W Y and Fung, I W H (2011) Tower crane safety in the construction industry: A Hong Kong study. "Safety Science", 49(2), 208-215.
- Ueltschy, L C (2001) An exploratory study of integration interactive technology into the marketing curriculum. "Journal of marketing education", 23, 63-72.

- Wallen, E S and Mulloy, K B (2006) Computer-based training for safety: comparing methods with older and younger workers. "Journal of Safety Research", 37(5), 461-467.
- Wilkins J R (2011) Construction workers' perceptions of health and safety training programmes. "Construction Management and Economics", 29, 1017-1026.
- White, C (2010) A socio-cultural approach to learning in the practice setting. "Nurse education today", 30, 794-797.

HEALTH AND SAFETY KNOWLEDGE IN COMPLEX NETWORKED ORGANISATIONS: TRAINING THE CHAIN

P.D. Bust⁵, A.M.Finneran⁶, R. Hartley³ & A.G.F Gibb⁴

^{1,2,4}School of Civil and Building Engineering, Loughborough University, UK

³School of Business and Economics, Loughborough University, UK

The study aims to identify what types of Occupational Safety and Health (OSH) knowledge and evidence circulate and work in relation to each other in organisations involved in networked delivery systems, how local actors in organisations interpret information and, in turn, the influences on OSH. To do this it is necessary to look at the way individuals in a network are trained as part of the information dissemination process. Training in work organizations produces clear benefits for individuals and teams, organisations, and society. The management of extended supply chains is a considerable concern for large organisations. The research used interviews of management and workers across three industry sectors (Construction, Healthcare and Logistics) and emerging findings show there to be problems with the way health and safety information is provided and the importance of key stakeholders in delivering the information.

Keywords: Training, knowledge, occupational health and safety.

INTRODUCTION

The study aims to identify what types of Occupational Safety and Health (OSH) knowledge and evidence circulate and work in relation to each other in organisations involved in networked delivery systems, how local actors in organisations interpret information and, in turn, the influences on OSH. This paper examines the training carried out in the networked industries and how this relates to OSH knowledge.

A review of training and development literature (Aguinis and Kraiger, 2009) stated individuals and teams, organisations and society all benefiting through the application of training and stress the importance of understanding the characteristics of the trainees (what motivates them) and the importance of training design, delivery and evaluation. In order to develop effective training a holistic view is required to understand how training will impact on the trainee and the work being carried out.

Organisations working in any nation state across Europe face similar problems with training. The nature of work is changing at a fast pace and the needs of the concerned parties (students, employers, teachers and trainers) in coping with these changes need to be understood. This includes the need for effective systems of qualification policies such as early school leavers, career guidance and the lifelong management of

⁵ p.d.bust@lboro.ac.uk

⁶ a.m.finneran@lboro.ac.uk

competences and skills (EUNEC 2011). The European Union wants to improve the level of formal education attainment for European citizens (Eurydice 2011) and also ways are being sought to enhance informal education (this includes training in the workplace) with initiatives such as validation of informal education and learning (Duchemin & Hawley 2010).

In the United Kingdom the Industrial Training Act was passed in 1964 to provide industry with adequately trained people, improve training methods, and apportion the cost evenly to firms. This allowed the government to set up training boards to fulfil these aims. By the 1990s the training boards had been replaced with a network of 82 Training and Enterprise Councils in England and Wales and 22 Local Enterprise Companies in Scotland. One of each of these bodies exists for the three sectors focused on in this research: construction, healthcare and logistics.

United Kingdom (UK) Training Boards

Construction Industry Training Board/ Construction Skills

A 2011 survey (Drever & Doyle, 2012) estimated the overall size of the construction workforce at 1,994,746. Of these, 49% (1.0 million) were in manual occupations and 51% were in non-manual occupations. Around 78% (1.55 million) were employees, 8% (150 thousand) were trainees and 15% (300 thousand) were self-employed. 86% (1.7 million) were men and 14% (300 thousand) were women.

In spite of a commitment to support skills development demonstrated by the majority of organisations in the construction sector, investment into skills and training is expected to remain at the bottom of the agenda for the majority of the sector in the short-term, resulting in limited development of staff (CITB, 2010).

Therefore, when the sector emerges from the recession, there are likely to be severe skill shortages due to a lack of investment in training and development (CITB, 2011). Reference is made to knowledge sharing within the sector as essential to support survival in the short-term and growth and development in the longer term but there is no reference to knowledge sharing between sectors (CITB, 2010).

Skills for Health

The health sector employs an estimated two million workers distributed across the UK. Almost 73% of workers are employed in the National Health Service, 26% are employed in the independent sector and 2% are employed in the voluntary sector. Females make up almost 80% of the total workforce which is also a little older than the average of other sectors, due to lengthy training periods for professional staff, where many professionals do not join the sector until their mid-twenties or early thirties. The opportunities for young people (16 - 21 year olds) are therefore limited to administrative and clinical support roles (SfH & LMI 2011).

There is evidence that training of the non-professional workforce must be linked to training of professionals. This need not always be simultaneous education, but it is essential that professionals are encouraged to support and accept colleagues from the wider workforce (Skills for Health, 2011).

The drivers of change impacting on healthcare will also have implications for the content of training programmes. In an environment in which team working and workforce flexibility will become more important, pre-registration and basic training

programmes will need to be adapted to equip staff with the skills needed in future (Bosanquet et al, 2009).

Skills for Logistics

The Logistics Sector employs 1.7 million people across 194,000 companies. It is dominated (84%) by workplaces employing 10 or fewer people. Including those who work in logistics occupations in other sectors, the actual size of the sector is 2.3 million people which equates to 8% of the UK’s workforce. The workforce is predominantly male (73%). Around 41% of the workforce is over 45 and only 10% are under 25 (SfL 2009).

The sector generally undertakes training at local training providers or specialist logistics providers, with bite-sized courses favoured. Of the 682,500 employees that had received training in the previous 12 months only 16%, or nearly 111,900 employees, trained towards a nationally recognised qualification (SfL, 2013).

Training and learning opportunities in the logistics sector have historically been low. However, the situation appears to be changing. It is boosted by the trend that transport oriented companies are switching to whole supply chain activities and require a higher level of customer service (Winters & Moloney, 2010).

Table 1: Summary of main demographics across the three industries

Industry sector	Workers (Millions)	% Male	%Female	% Workers aged under 25	% Workers aged over 45
Construction	1.995	86	14	10	41
Healthcare	2.000	20	80	7	47
Logistics	1.700	73	27	10	41

Work, Knowledge and Training

In order to adopt a holistic view when considering occupational activities from a Human Factors perspective it is important to consider the five elements that make up the work system (individual, task, equipment, environment and organisation). These can be characterised as shown in table 2 below.

Table 2: Characteristics of the five elements of the work system (adapted from Smith & Carayon-Sainfort, 1989)

Individual	physical and cognitive characteristics
Task	demands of the work
Equipment	available assistive technology
Environmental	working conditions
Organisational	support or pressure applied through the organisation

Providing training in the five areas listed in table 2 increases workers resources to deal with workplace stressors present in each of the areas (Smith & Carayon-Sainfort, 1989).

The development of training along the lines of the training transfer model, Figure 1 below, considers both the organisation and the environment. The organisation can

provide the motivation (in the form of incentives) for workers to use what they have learned in training when returning to the workplace. The work environment is important because workers, after training, will respond to cues in the environment when carrying out their work. (Lingard & Rowlinson 2004)

The content of this paper is drawn from a research project funded by the Institution of Occupational Safety and Health (IOSH). The project aims are outlined in the introduction. The Loughborough team have also won a second project extending the knowledge flow and engagement study to SME and micro organisations in all three sectors. Both projects form part of a bigger research programme seeking to map the new landscape of OSH and to explore its implications for reconciling contributions to economic success and wealth creation with effective protection to workers, their families and their communities.

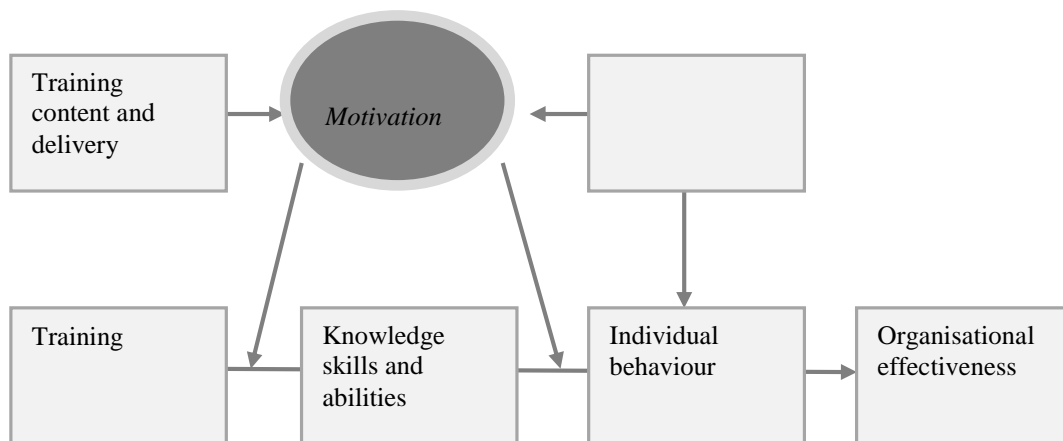

Figure 1: Training transfer model from Holton (1996) adapted by Lindgard and Rowlinson

Various types of knowledge have been identified as part of this project. Lundvall and Johnson (1994) regard knowledge as embedded in the social context. They suggest a taxonomy of economically relevant knowledge based on four broad categories (Table 3). Knowledge is more than information, since it involves an awareness or understanding gained through experience, familiarity or learning. However, the relationship between knowledge and information is interactive. Knowledge creation is dependent upon information, yet the development of relevant information requires the application of knowledge (Roberts, 2000).

Table 3: Types of knowing (adapted from Lundvall & Johnson, 1994)

know-what	referring to knowledge about 'facts'
know-why	referring to scientific knowledge of principles and laws of motion in nature, in the human mind and in society
know-who	referring to specific and selective social relations
know-how	referring to skills

If we overlay the work system elements with the four broad knowledge categories (Figure 2) it can be seen that, for any work task, training of the operative can: provide information of the task, equipment and environment; generate interest in the work and provide details of those to contact if assistance is required. However, until the work is actually commenced and interaction takes place between the worker and the other work system elements they will not actually know for certain how to complete the task.

Workers can be given all the information they need, have a great interest in all aspects of the job and have a good support contact network to call on for guidance. But, until they interact with the task in its environment they will not know how to do it. The challenge is how to prepare workers for what they are likely to find when turning up to attempt a task. In a study of learning in the workplace (Collin, 2010) it was found that learning was most frequently described as the outcome of the evaluation of one's work experiences and of co-operation and interaction with colleagues.

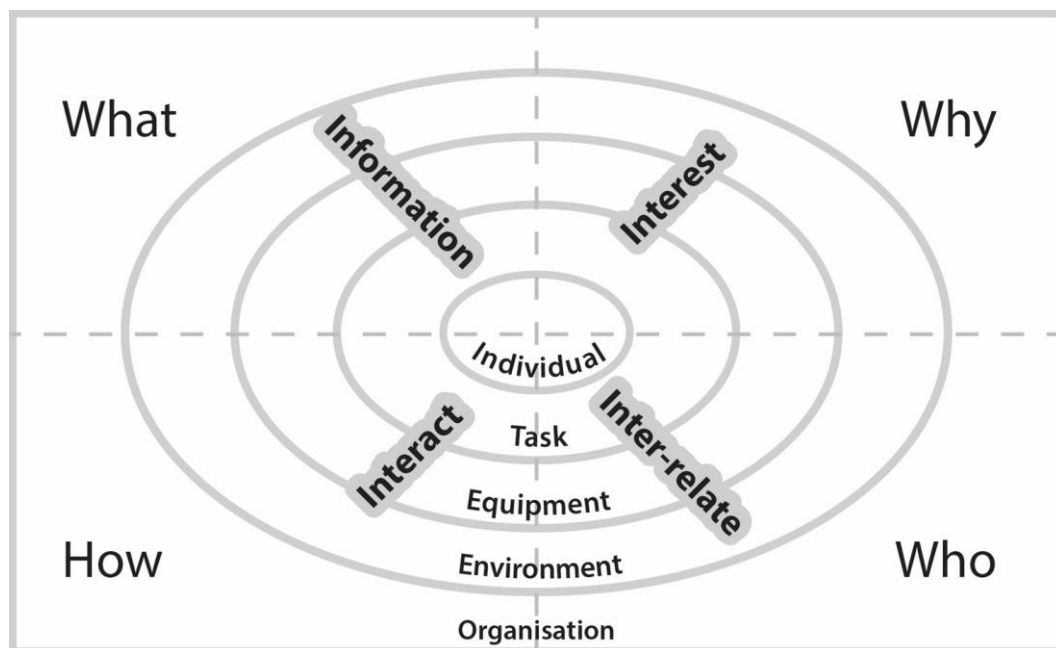

Figure 2: Work system elements overlaid with broad knowledge categories.

For effective training to take place it is essential that trainers provide the relevant information for individuals to carry out the work but also provide contacts to call with

any queries, develop the workers interest in the task to be undertaken and give them an idea of what they are likely to interact with when they perform the task. This is supported by (Santos & Stuart, 2003) who said that training failed due to content not being sufficiently tailored to practical demands and that environment work factors hindered participants' ability to implement learning.

RESEARCH DESIGN / METHODOLOGY / APPROACH

The main project takes a unique approach, combining safety science, human factors, and social science approaches across three industry sectors: healthcare, logistics and construction with the goal of sharing good practice and innovation initially between each of the three sectors and eventually to other sectors. Methods include interviews and focus groups supported by short term ethnographic interventions. The ethnographic interventions are not covered in this paper.

A desk study examined the extent and state of the UK and international OSH landscape. This included reference information that OSH practice needs to draw on as well as the knowledge base for intervening generally and in specific situations. The approach of the review was guided by prioritizing the user focus: “what knowledge do the key stakeholders in OSH activity need and in what form?”

Fieldwork consisted of two separate but strongly interlinked parts: interview-based studies and on three selected field sites (one from each sector) detailed ethnographic studies (the ethnography is not covered in this paper). Two major contractors in construction, three hospitals in the Midlands region of the UK and the logistics arm of a national UK store all provided managers and workers for interview.

The methodology was developed and agreed with the funder and the peer review panel prior to commencing, based on the following principles. How different levels and types of knowledge are learned, transferred and implicated in a range of practices, in particular occupational, social and material contexts. The routes that different knowledge and practices follow as they move along social and occupational networks were examined, as well as how they become accepted, rejected, incorporated, appropriated and modified in use.

The cross sectional approach was used to produce comparative studies in the three industrial sectors. Following Bryman (2008), sampling was done at three levels – the sectors, the case-study organisations and individuals being observed and interviewed. The comparison between the three different sectors allow enlightening comparisons between organisational delivery contexts that are more or less networked and distributed to be made.

In-depth semi-structured interviews in two phases used to explore: participants first-hand accounts of their experiences of learning, communicating and applying knowledge in the workplace; their own ‘local knowledge’, how this had been accumulated biographically and through which social and institutional workplace contexts; their experiences across a range of contexts; their (sometimes critical) reflections on knowledge and learning in the workplace, and their notions of good practice; their understandings of the way knowledge is used in the workplace. The interviews were audio-recorded and transcribed.

The ethnographic research consisted of about 25 days intensive fieldwork at each site. The sample of participants encompassed the person's working in the field site engaged in participant observation activities. The ethnographer also completed a series of structured research encounters, which engaged around 20 participants in each field site.

EMERGING FINDINGS

These emerging findings are from the first phase of interviews and focus groups only and consider the training aspects of those findings. The following are industry specific and are not representative across all three industries. Findings have been grouped into the four knowledge areas.

Know what/ information

Personal overload from too much information in the form of emails affecting the impact of new health and safety messages.

Trainers of frontline construction workers reported having to translate the information in order that it could be understood.

Care taken to provide information relevant to both the operator and the task at hand. A trade-off between the amount of information provided in training and the level of supervision provided to the workforce.

Evidence of the importance of training that meets the cognitive, physical and social needs of the operator.

Putting systems in place to promote organisational learning and feedback to update and improve the available knowledge and information is recommended.

Know why/ interest

Workers given a better understanding of health and safety risks by trading places with workers of a different trade. An electrician was put onto a construction vehicle to be made aware of the driver's visibility of others around the vehicle.

Incentives given to workers to increase interest in health and safety. Monetary incentives were given in the form of shop vouchers to encourage workers to provide hazard/ close call reports.

Know how/ interaction

Pre-tender assessments on existing health and safety performance criteria used to establish the sub-contractors level of health and safety performance levels.

Important consideration need to be given to the design of the environment and the user's interpretation of visual, auditory and social cues. For example, healthcare workers, including domestic staff, are guided by stickers on doorways to inform them of the correct personal protective equipment and health precautions to be taken where the use of written instructions could be considered ethically unsound and affect patient dignity.

Know who/ inter-relation

There was no indication that social relationships between team members (which are known to impact how messages and knowledge are translated and perceived) were included in training.

Characteristics of the message giver such as trustworthiness, close social and working relationships, and practical knowledge of job roles appear to be key factors that help get their message across.

The importance of face to face communication in getting a message across cannot be underestimated. Key message givers (such as nurses or construction/logistics supervisors) have been identified as knowledge hubs in each of the sectors. Workers encouraged to speak to any member of the project team with any queries if they have doubts about the work they are undertaking. Awareness and implementation of OSH procedures is high across logistics companies. The overwhelming majority of companies have an OSH representative. Nearly all undertake OSH training.

In addition there was no evidence to suggest that dealing with dynamic tasks, multiple players, shifting goals, time pressure, incomplete or conflicting information, visual, auditory and information overload in high pressure situations was used. In healthcare there was concern that frontline workers were not given appropriate training and there was little evidence to suggest that the variable environments, human elements (physical and cognitive) as well as task demands had been taken into account in the training.

DISCUSSIONS

The findings show that there is pressure on the health and safety management from advances in technology as seen in the examples of information overload increasing with the ability to send larger numbers of emails to all of your contacts whenever a relevant topic becomes known.

In line with Lingard and Rowlinson's adapted training transfer model, figure 2 above, there are signs from the findings that motivational methods are being used by organisations to encourage their workers to adopt health and safety management practices such as the incident reporting. The effect of the working environment is also noted in the health setting example where visual cues are used to assist in the delivery of the health and safety message.

It can be seen that it is possible to separate the health and safety areas of training into the four knowledge areas and five work elements making it possible to concentrate on smaller parts of the overall bigger health and safety management picture. Thus enabling those tasked with the development of health and safety training to see which knowledge areas and work elements have not been addressed in existing training. The following example, from the interviews, shows how this can be achieved.

Example: Install pipe through existing masonry wall.

When carrying out the work it was not possible, due to lack of space, to use lifting equipment to raise the pipe, which weighed more than 200kg, into a position where it could be fed through the existing wall. The worker asked his colleague to assist him and worked out a plan to prop the pipe up and use chains to lift it into place. This was against the organisations rules for manual handling but they said that they took their time in order to do it safely and wanted to get on with the work so as not to hold the job up.

Considering the task and knowledge areas:

The worker is the individual who is carrying out the task, install pipe through existing wall, with whatever tools are available, equipment, in an environment, the construction site for an organisation, the main contractor.

Know what - this is the information required to do the task. The workers had received training (including safety and behaviour training) on how to do their job. They were told by the organisation where the work was to be carried out and what the task entailed. Know why - this is having interest or an understanding of how things work and why safety measures are needed. Know who - this is an inter-relation with people that can provide them with further information. Difficulties arose during the installation work and they sought assistance from a colleague, as a favour and some different equipment. They would have known who to contact if they suspected that the work represented a safety hazard. Know how - knowing how to do something requires an interaction with the elements of the work. Their previous work activities (construction work, pipe installation and use of lifting equipment) had not prepared them for the circumstances they faced when starting this task. It was only when starting the work that they called upon the other knowledge areas to find a solution.

The training development can benefit from these examples when breaking them down as shown above. This can be done by identifying the knowledge areas that were called upon to find a solution to rectify any errors (calling upon colleagues instead of staff) and looking at the areas not used to improve training content. Figure 3 is an overview of the benefits of increasing training content in the four knowledge categories.

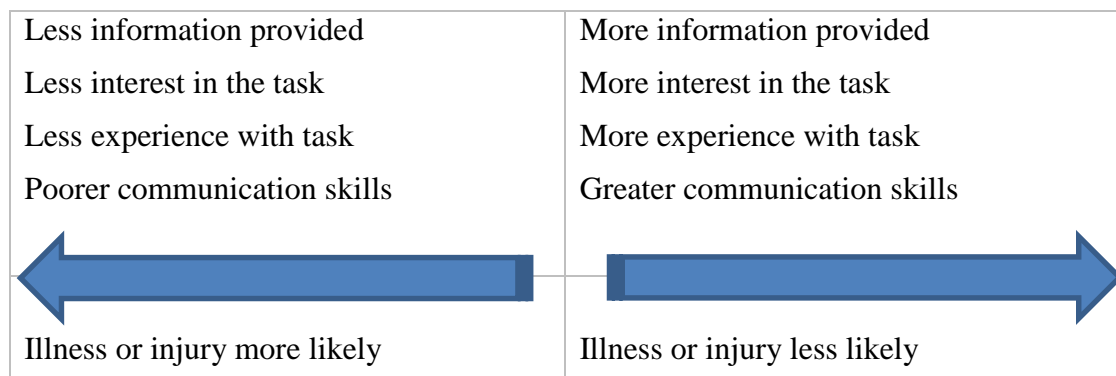

Figure 3 Results of change in training content in the four knowledge categories.

Limitations of the research

The research project is on-going and the analysis of data has not yet been completed. A second phase of data collection will be underway soon to fill gaps in the data before a further round of analysis is undertaken. Responses to this paper will be used to assist with the final stages of the project.

CONCLUSIONS

Training research literature continues to show a variety of benefits for providing training to individuals, organisations and society. However the training methods/content appears to need changing on a regular basis to keep up to date with

the changing work environment in the face of rapid technology advances and globalisation.

Emerging findings show there to be problems with the health and safety information being provided in the form of work overload and in the translation of information so that it can be understood by workers and the importance of key stakeholders (health and safety manager, supervisors and colleagues) in delivering health and safety information. It is proposed that a holistic approach can address some of these issues by breaking down work tasks into knowledge areas and work elements in order that trainers can see more clearly where their efforts need to be directed. Future research of the work/knowledge model is required with trainers to see how effective this can be.

REFERENCES

- Aguinis, H. & Kraiger, K. 2009 Benefits of training and development for individuals and teams, organizations, and society. *Annual. Revue of. Psychology.* 2009. 60:451–74.
- Bosanquet, N., Buchan, J., Ham, C., Imison, C., Martin, G. and Stoten, B. 2009. *Tomorrow's workforce: Commentaries on the future of skills and employment in the UK's health sector.* Skills for Health Bristol.
- Bryman, A (2008) *Social Research Methods.* Oxford University Press.
- CITB 2010. *Understanding Future Change in Construction Final Report October 2010.* Construction Industry Training Board October 2010.
- CITB 2011. *Ready for Work? The work readiness of entrants to the UK Construction sector who have work-related qualifications.* Pye Tait Consulting Royal House 110 Station Parade Harrogate.
- Collin, K. (2002). Development engineers' conceptions of learning at work. *Studies in continuing education*, 24(2), 133-152.
- Drever, E. and Doyle, M. 2012. *Survey of Employment by Occupation in Construction 2011 for Construction Skills.* NatCen Social Research 35 Northampton Square London EC1V 0AX.
- Duchemin, C. and Hawley, J. 2010, *European Inventory on Validation of Nonformal and Informal Learning 2010 Thematic Report – Validation for Specific Target Groups.* European Centre for the Development of Vocational Training (2012).
- EUNEC 2011, 'New Skills For New Jobs' Challenges For Vocational Education and Training In The 21st Century. Report of the conference of the European Network of Education Councils (EUNEC), Lisbon , 24-26 October 2011 with the support of the European Commission DG Education and Culture.
- Eurydice 2011, *Adults in Formal Education: Policies and Practice in Europe.* Published by the Education, Audiovisual and Culture Executive Agency (EACEA P9 Eurydice). ISBN 978-92-9201-147-5.
- Lingard, H. & Rowlinson, S. 2004 *Occupational health and safety in construction project management.* Routledge.

Lundvall, B.-Å. and Johnson, B. (1994), 'The learning economy', *Journal of Industry Studies*, Vol. 1, No. 2, December 1994, pp. 23-42.

Roberts, J. (2000). From Know-how to Show-how? Questioning the Role of Information and Communication Technologies in Knowledge Transfer. *Technology Analysis and Strategic Management*, 12(4), 429-443.

Santos, A. and Stuart, M. 2003. Employee perceptions and their influence on training effectiveness. *Human resource management journal* Vol.13 No.1 2003.

Skills for Health 2011. Does training the wider workforce make a difference? Rapid review of international evidence Report produced by The Evidence Centre for Skills for Health.

SfH and LMI 2011. UK Sector Skills Assessment 2011 Full Report. Skills for Health (Head Office) Goldsmiths House Broad Plain Bristol.

SfL 2009. The Logistics Sector Skills Assessment Research and analysis of the past – forecasting of the future. Skills for Logistics Milton Keynes.

SfL 2013. Supply chain management: Occupational craft skill report August 2013. Skills for Logistics Milton Keynes.

Winters, G. and Moloney, R.2010. Employer Forum Consultation: Training practices. Skills for Logistics Milton Keynes.

Creating an incident free work environment

AN INTEGRATED FRAMEWORK FOR STRATEGIC SAFETY MANAGEMENT IN CONSTRUCTION AND ENGINEERING

Riza Yosia Sunindijo⁷ and Patrick X.W. Zou²

¹ *PhD, Lecturer, Faculty of Built Environment, UNSW Australia, UNSW SYDNEY NSW 2052 AUSTRALIA*

² *PhD, Professor, Faculty of Business, Government and Law, University of Canberra, ACT 2601 AUSTRALIA*

The construction industry has remained as one of the most dangerous industries worldwide. There is a need to integrate safety into decision making and practices in construction organisations if safety performance is to be improved. This paper contends that strategic safety management, which involves the acts of balancing the science and art of safety management, is a way forward to achieve the desired integration and continuous improvement. In this paper an integrated strategic safety management framework is proposed to help construction organisations develop, implement, and evaluate their safety strategies. The framework covers key safety strategies including understanding the economic benefits of safety, developing safety culture in the organisation and supply chain, equipping staff with safety leadership skills, creating an environment that promotes safety learning where andragogy principles are applied, incorporating safety in design process, and evaluating safety strategies using a balanced scorecard method. Following this, a case study is presented to demonstrate the development, implementation, and evaluation of strategic safety management in construction business practice. Commitment from top management and collaboration among key stakeholders are needed to overcome barriers of strategic safety management, such as the misalignment of strategy implementation across different management levels in the organisation and the resistance to change. The strategic safety management framework and case study presented in this paper may provide food for thought to the academics and practitioners for future improvement of construction safety performance.

Keywords: construction safety, strategic safety management, safety culture, safety risk management.

INTRODUCTION AND RESEARCH AIMS

Although construction safety performance has improved significantly in the past century, recent trends show that the industry is facing difficulties to further improve its performance while injuries and fatalities still happen regularly. Today, major construction organisations recognise the need to integrate safety into all decision making processes (Finneran and Gibb, 2013). We advocate that strategic safety management is a way to achieve the level of integration required, to eliminate safety risks, and to achieve the desired cultural maturity. Hale and Hovden (1998) argued

⁷ r.sunindijo@unsw.edu.au

² Patrick.Zou@canberra.edu.au

that safety has evolved through three ages of safety: technical, human factor, and management systems. Hudson (2007), on the other hand, argued that there are three waves of safety development: technology, systems, and culture. Both views propose a solid argument and instead of choosing a side, we posit that both views can be harmoniously integrated. Many countries have made significant improvement in safety through the development and application of systems, structures, and technology. However, although necessary, they are inadequate to improve safety performance further. This is because no matter how automated a production process or complex a management system is, people cannot be entirely separated from the process or the system. Unfortunately, people tend to make mistakes, thus making human error as an undesirable, but inseparable, aspect of everyday life (Lingard and Rowlinson, 2005). In essence, construction organisations should recognise the need to balance the ‘science’ and ‘art’ of safety management.

The aim of this research is to develop a strategic safety management framework that enables the integration of the science and art of safety management into construction business and project management practices.

A STRATEGIC SAFETY MANAGEMENT FRAMEWORK

There are many schools of thought on strategy. The definition proposed by Johnson et al. (2008) is practical and favoured by industry professionals as it emphasised key terms considered important to construction organisations. They defined strategy as the direction and scope of an organisation over the long term, which achieves advantage in a changing environment for the organisation through its configuration of resources and competences with the aim of fulfilling stakeholder expectations.

There are three dimensions of strategy that can be recognised in every real-life strategic problem situation (de Wit and Meyer, 2010; Price and Newson, 2003):

- Strategy process, which is the manner in which strategies come about. It is concerned with the how, who, and when of strategy: how should strategy be made, analysed, formulated, implemented, changed, and controlled; who is involved; and when do the necessary activities take place?
- Strategy content, which is the product of a strategy process or the what of strategy. It addresses a question like: what should be the strategy for the organisation and its constituent units?
- Strategy context, which is the set of circumstances under which both the strategy process and content are determined. It is concerned with the where of strategy, such as the organisation and environment where the strategy process and content are embedded.

By applying the above definition and dimensions of a strategy to construction safety context, we contend that the strategy process consists of strategy development, strategy implementation, and strategy evaluation. The strategy content is the different aspects of safety management that should be integrated into construction business and project practices. As mentioned earlier, these aspects include the ‘science’ and ‘art’ of safety management. The strategy application context is construction organisations, construction project management, and the industry in general.

Safety mission, goals and core competency

Figure 1 is developed by referring to the strategic management model developed in the construction management new directions 3rd edition by McGeorge and Zou (2013). At the core of the framework are safety mission, goals, and core competencies which can be considered as the foundation and starting point of strategic safety management. It postulates that safety should be included in the mission statement as one of the underlying philosophies in organisational operations. This mission should then be translated into strategic goals and operating objectives against which actual organisational performance is measured. The core competency should include employees' safety leadership, knowledge, and experience.

Once the foundation is set, the next step is to formulate safety strategies, i.e., establishing strategy content. Each of the components is discussed in details in the following section. It should be noted that although Figure 1 indicates a separation between the 'science' and 'art' aspects of safety, they are interrelated in practice. For example, although safety culture is widely accepted as part of the behavioural aspect (art) of safety, safety management system is a dimension of safety culture and it is closely related to the science of safety.

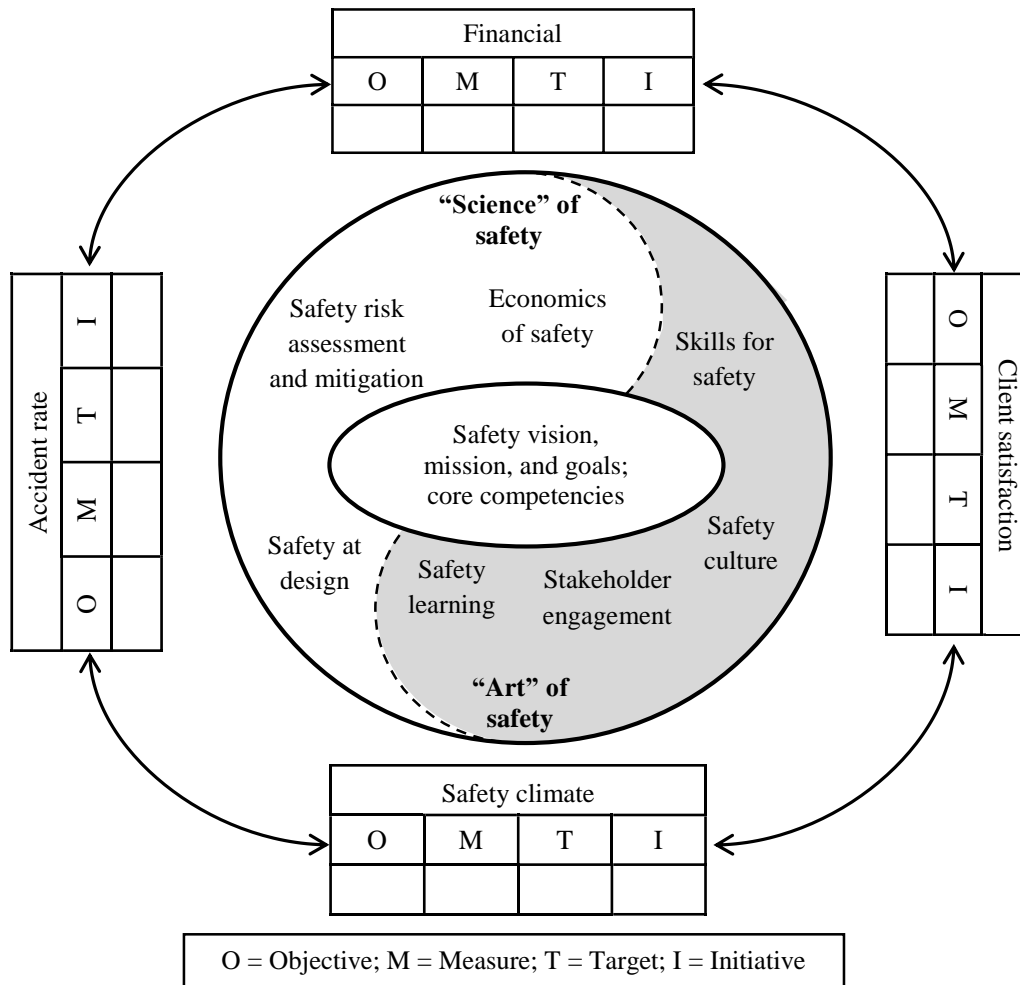

Figure 1: A conceptual framework of strategic construction safety management

Economics of safety

Decisions in relation to safety provisions may not be based upon ethical considerations and basic rights to safety at work, but upon economics. Safety investment and management is able to generate economic advantages for construction organisations. A construction safety program may yield as much as 46% of return on investment (Zou et al., 2010), while lack of safety has an adverse impact because an accident may cost up to AUD1.6 million (Sun and Zou, 2010). Furthermore, since safety is enforceable in law, lack of safety may lead to prosecution and claims which will incur extra costs, delay the project, cause adverse publicity, and threaten the financial health of the organisation.

Contractors, including head contractors and subcontractors, should realise the importance and economic benefit of investing in safety management. Furthermore, the abovementioned economic reasons also demonstrate the need to address safety issues by looking at stakeholders higher in the supply chain, particularly clients who have the economic power to facilitate safety implementation. Clients should realise that without their supports, contractors will face a lot of constraints in implementing safety measures due to the competitive nature of the industry. They need to commit to safety by allocating sufficient budget and time for implementing safety measures. Therefore, safety should become one of the contractor selection criteria or prequalification criteria in the tender evaluation process. Contractors and clients should also

collaborate by committing necessary resources to use innovative safety measures when the opportunity arises. Through this attention to safety, clients will eventually reap its economic benefit.

Safety culture

The term safety culture can be traced back to the Chernobyl nuclear accident in 1986 when a poor safety culture was identified as a contributing factor to the disaster (IAEA, 1986). Since then, safety culture has increased in popularity and its poor implementation has been constantly highlighted as the key source of major accidents. Initially, the definition and management of safety culture remain largely unclear. Different organisations interpret safety culture differently and, as a result, use different approaches to implement the notion in practice (Cox and Flin, 1998; Pidgeon, 1998). Over the years, the definition of safety culture has converged and the concept has become clearer with a solid theoretical underpinning. Fernández-Muñiz et al. (2007) offered a lengthy, yet comprehensive definition of safety culture as follows: a set of values, perceptions, attitudes and patterns of behaviour with regard to safety shared by members of the organisation; as well as a set of policies, practices and procedures relating to the reduction of employees' exposure to occupational risks, implemented at every level of the organisation, and reflecting a high level of concern and commitment to the prevention of accidents and illnesses.

Safety culture has three distinct but interrelated manifestations: psychological, behavioural, and corporate. The psychological dimension refers to the safety climate of the organisation, which encompasses the attitudes and perceptions of employees towards safety and safety management systems. The behavioural dimension is concerned with what people do within the organisation, which includes the safety-related activities, actions, and behaviours exhibited by employees. Lastly, the corporate dimension refers to the organisation's safety policies, operating procedures, management systems, control systems, communication flows, and workflow systems (Health and Safety Executive, 2005).

Developing a strong safety culture requires managers to focus on developing five sub-cultures (Hopkins, 2005; Reason 2000). First is informed culture, a cognitive element in an organisation manifested in the alertness to the possibility of unpleasant surprises and having the collective mind-set necessary to detect, understand, and recover them before they bring about bad consequences. Second is reporting culture, the readiness of employees to report mistakes, near misses, unsafe conditions, wrong procedures, and other safety concerns. Third is just culture, the organisation's willingness to expose areas of weakness to improve performance. With just culture, employees are accountable for their actions, but will not be blamed for system faults beyond their control. Fourth is learning culture which encourages organisations to process safety reports or any other safety information conscientiously and make changes as necessary to remedy or improve the situation. Fifth is flexible culture, which is manifested in a flexibility to shift from the conventional hierarchy mode to a flatter structure where control passes to task experts on the spot, and then reverts back to the traditional mode once the emergency has passed.

There is a tendency to focus only on safety culture within an organisation. This is inadequate due to the nature of the industry where subcontracting practice and the involvement of numerous stakeholders are common. Therefore, developing safety culture across the supply chain, i.e., inter-organisational safety culture, could be the

next challenge to deal with (Fang and Wu, 2013). Furthermore, some organisations are operating globally and facing differing cultural backgrounds which will greatly influence the interpretation and implementation of safety policy and safety system. More cross-cultural research is needed to achieve the desired integration of safety strategies across business units.

Safety skills and learning

Employees, who are in safety critical positions, need to provide safety leadership so that safety implementation is aligned from the top to the lowest management level. Zou and Sunindijo (2013) have developed a model which is composed of essential skills for providing safety leadership. In their model, the foundational skills are self-awareness, visioning, and apparent sincerity. The first-tier mediator skills are scoping and integration, and self-management. The second-tier mediator skills are social awareness, social astuteness, and relationship management.

Employees, including project personnel, should be equipped with these safety skills and with necessary safety knowledge to enable them to work safely and to encourage others to do the same. As such, construction organisations should advance a climate which values safety learning. Many organisations associate learning with pedagogical methods, such as lectures and presentations, assigned readings, and examinations. This approach, although necessary, does not suit well to adult learners, particularly those who have a substantial work experience. Therefore, the principles of andragogy should be applied in the safety learning process. Andragogy is a teaching approach which assumes that learners are self-directed and problem-centred in learning, thus teachers or trainers should be facilitators of learning instead of giving instructions in a didactic way. The physical environment, such as classrooms, materials and resources, policies, and evaluation methods, should support the learning process. The psychological environment should encourage freedom of expression and cause trainees to feel accepted, respected, and supported. Trainers can play a facilitating role by involving the trainees in diagnosing their own needs, formulating learning objectives, devising strategies to achieve the objectives, and evaluating learning results (Knowles, 1980).

Furthermore, safety learning should not only be considered as an acquisition of knowledge through instructions and training in classrooms or other formal settings (Tsoukas and Mylonopoulos, 2004). Safety should also be considered as the final outcome of a dynamic and collective construction process. In this case, a safe workplace is the result of constant engineering of diverse elements, such as knowledge and skills, equipment, and social interactions, which are integral to the work practices of various project stakeholders. In other words, learning about safety involves taking part in the social world, i.e., learning takes place among and through others (Gherardi and Nicolini, 2002).

Another aspect of safety learning often neglected is the assessment of the effectiveness of existing training methods. Kirkpatrick (1979) developed a four-level training program evaluation process which consists of reaction, learning, behaviour, and results. Reaction evaluates the satisfaction of trainees on the training program and its delivery methods, e.g., a satisfaction survey. Learning evaluates the amount of knowledge gained by trainees, e.g., tests and demonstrations. Behaviour evaluates the extent to which trainees apply what they have learnt into their job, e.g., observations, interviews, and surveys. Results evaluate the final results that occur due to training,

e.g., job satisfaction and morale, productivity improvement, reduction in the number of accidents, increased profits, and better client satisfaction.

Safety at design (aka designing for safety, prevention through design)

There is only so much that can be done in terms of safety during the construction stage. Therefore, within the life cycle of a construction project, safety should be considered during the earlier stages. Many studies have revealed that considering safety in the design stage, including architectural and engineering designs, has a great potential to significantly reduce the number of accidents during the construction stage. The segregation in the construction industry, particularly between designers and contractors, is one of the key challenges in undertaking safety check at design. When designers have a lack of experience in construction processes, this segregation may increase safety risk during construction and operational stages.

Some strategies can be used to address this issue. Design and build project delivery system is a practical strategy to promote communication between designers and contractors as early as possible. Within a more traditional design-bid-build contract arrangement, the involvement of engineers or consultants with safety knowledge can lead to enhanced safety outcomes. Constructability reviews also provide an opportunity to integrate safety into design as long as safety is made a priority in such reviews and participants are sufficiently equipped with construction safety knowledge. Government policies and support, such as the Construction Design and Management (CDM) regulations in UK, is another strong instrument for supporting safety at design (Weinstein et al., 2005).

Safety Risk Assessment and Mitigation

Safety risk assessment and mitigation is a tool for incorporating safety early in a project life cycle. A construction organisation has successfully implemented a program called ROAD (risk and opportunity at design) to perform risk and opportunity analyses at the design stage. This program has benefited the organisation by improving workers' safety, preventing accidents at the design stage, improving safety of building users, generating cost savings, and improving productivity (Zou et al., 2008). During the construction stage, a practical tool to assess and mitigate safety risks is a safe work method statement which should be prepared before a high risk construction activity begins. This document states safety risks arising from the activity, describes how the risks will be controlled, and describes how the control measures will be implemented, monitored, and reviewed. It should also be readily accessible and easy to read.

Evaluating safety strategy

By referring to the strategic management model developed in McGeorge and Zou (2013) and adopting the balanced scorecard approach introduced by Kaplan and Norton (1996), four dimensions were identified to evaluate the effectiveness of safety strategies. The first dimension is financial performance which can be measured by organisation's profit, accident compensation costs, and safety-related insurance premiums. The second dimension is client satisfaction which can be measured by satisfaction survey, organisation's reputation, and share prices. The third dimension is safety climate which measures the attitudes and perceptions of employees towards safety. The fourth dimension is accident rate which represents the number of accidents per 100k or 1 million work hours on site. Within each dimension, objectives,

measurement indicators, achievement of target performance, and improvement initiatives should be determined. It should be noted that beyond these dimensions, there are other quantitative and qualitative indicators for evaluating construction safety performance. The indicators will highly depend on the strategy context.

CASE EXAMPLE

This section presents a strategic safety management case study in Lend Lease (LL), the second largest construction company in Australia. LL employed over 16,500 employees across the globe with revenue of more than \$12 billion in 2013 (Lend Lease, 2014). The company is highly committed to safety and strives to operate Incident and Injury Free (IIF) wherever it has a presence. The strategy context is the construction industry, particularly within Lend Lease business practices. The strategy process consists of three steps: developing, implementing, and evaluating IIF strategy, which will be further discussed below. The strategy content is to focus on the human side of safety by initiating cultural change so that safety values are embedded into all employees and all stakeholders are involved in and accountable to safety. Data were collected from the company's website, annual reports, and interviews and correspondences with a safety manager.

Developing the IIF strategy

Although its safety record was much better than the industry average performance, LL recognised that the number of fatalities and serious injuries had reached a plateau despite of its advance system, equipment, and processes. LL decided that to achieve a breakthrough, they need to focus on the human side of safety and to initiate a cultural change whereby every employee is instructed and actively encouraged to put safety first. LL strives to empower their people to believe that they can achieve a workplace free of incidents, injuries, and deaths. With this vision in mind, LL launched an IIF safety initiative in 2002 which is about a journey to improve safety through the development of a mind-set that is intolerant of any incident and injury (Lend Lease, 2014).

Implementing the IIF strategy

LL's IIF strategies are anchored by three objectives and implementation actions: Owning, Enabling, and Sustaining. First, owning - LL believed that the commitment and involvement from all parties from all levels is important for this initiative to succeed. It is essential to create an environment where the workers believe that all injuries are preventable; no injury is acceptable; and schedule, cost or production are not ranked ahead of an injury-free workplace. The strategies to support 'Owning' include engaging stakeholder to win their commitment to IIF vision. The IIF becomes a core value and works as a driver for LL in all its operations.

Second, enabling - the strategies to support this include the organisational alignment with IIF where all the policies, management structure, and roles are restructured and redesigned to align with the IIF vision. Lines of accountability and authority were established to identify key positions throughout the company. Communication plan is developed and implemented to shift the culture and behaviours of the organisation and employees to the IIF vision. In terms of learning, LL has a range of orientation and training programs to ensure that employees are aware of the health and safety risks associated with their activities and the measures needed to control them, and understand the IIF vision. The company developed a global online Safety Passport

course with training modules on IIF and the Global Minimum Requirements (GMRs) that set out the minimum environment, health, and safety standards for controlling the risks associated with LL operations. Besides the Safety Passport training, employees and subcontractors must also undertake technical and management training to enable them to deal with the specific health and safety risks in their roles. Contractors that perform specialist/high-risk operations are required to produce proof of competence before starting work (Lend Lease, 2014).

Third, sustaining - LL aspires to sustain and lead the industry by sharing the benefits of the organisational transformation with their stakeholders. LL invests in research, innovation, and benchmarking to continually redefine the vision. It also sustains leadership commitment by reviewing, recognising, and rewarding behaviour of leaders for achieving the IIF vision. A 'living' communication plan is used to capture feedback from all stakeholders. The IIF system is also evaluated periodically to facilitate the transformation process towards the IIF vision (Zou et al., 2006).

Evaluating the IIF strategy

LL's safety management system and GMRs set specific requirements for performance monitoring and evaluation. The results of checks, inspections and audits are recorded in an online reporting tool, called WebCare, and the data used to identify problem areas and implement actions to deliver improvements. Significant incidents and lost time accidents are recorded and reported. Serious incidents are thoroughly investigated and Root Causes Analysis (RCA) is conducted to identify the underlying causes of incidents and the needs to change. In 2013, LL achieved zero fatalities, their first fatality free year on record. This is supported by 6% and 9% growth in revenue and profit respectively (Lend Lease, 2014). In partnership with a university, they conducted a study to measure the benefit of their investments in safety and the results show that due to superior safety performance, their investment in IIF safety strategy has generated positive return 46% in one of their case projects (Zou et al., 2010).

CONCLUSION

This paper proposes the following recommendations to implement strategic safety management into construction businesses. First, construction organisations and stakeholders should understand the economic benefits of safety so that they are willing to invest in and support safety implementation. Second, safety culture should be developed, not only within an organisation, but also across the supply chain. Third, safety at design, including architectural and engineering designs, is a practical way to improve safety by mitigating safety risk early during project life cycle and by improving communication between designers and contractors. Fourth, all employees should be equipped with necessary safety skills and knowledge to enable them to be safety leaders in their workplace. Fifth, safety learning should embrace the principles of andragogy in order to be effective, particularly to provide safety training to experienced workers. Sixth, a balance scorecard method can be used to measure the effectiveness of strategic safety management of construction organisations.

In conclusion, we argue that strategic safety management is a feasible way to achieve the desired maturity of safety management and its integration into decision making processes in the construction industry. Commitment from and collaboration among key construction stakeholders (clients, contractors, consultants, and governments) are crucial for such an integration to become a reality. We anticipate that the conceptual

strategic safety management framework proposed here can be a starting point for practical application and for future studies to examine into each of its components. It should be noted, however, that implementing strategies is never a simple task, thus two key barriers are worth mentioning. First, there is a misalignment from the company's boardroom decision making to its implementation throughout the organisation (Sunindijo and Zou, 2013). Hrebiniak (2006) explained that there is a separation between strategy planning and execution where the planners (the "smart" people) develop plans that the "grunts" (not quite as smart) have to make the plans work. When things go awry, the problem is attributed to the "grunts". The second barrier is resistance to change. People, who have been in the industry for many years, believe that they 'know' how to work and do not like to change. They tend to resist new things that they do not understand. Although some may realise that there is a better and safer way to work, but since they have done it in a certain way for a long time, it could be hard for them to change (Sunindijo and Zou, 2013).

REFERENCES

- Cox, S J and Flin, R (1998) Safety culture: Philosopher's stone or man of straw? "Work & Stress", 12(3), 189-201.
- de Wit, B and Meyer, R (2010) "Strategy Synthesis: Resolving Strategy Paradoxes to Create Competitive Advantage (Text and Readings)." 3ed. London: Thomson Learning.
- Fang, D and Wu, H (2013) Development of a safety culture interaction (SCI) model for construction projects. "Safety Science", 57, 138-149.
- Fernández-Muñiz, B, Montes-Peón, J M, and Vázquez-Ordás, C J (2007) Safety culture: Analysis of the causal relationships between its key dimensions. "Journal of Safety Research", 38(6), 627-641.
- Finneran, A and Gibb, A (2013) "W099 - Safety and Health in Construction Research Roadmap - Report for Consultation CIB Publication 376." CIB General Secretariat.
- Gherardi, S and Nicolini, D (2002) Learning the trade: A culture of safety in practice. "Organization", 9(2), 191-223.
- Hale, A R and Hovden, J (1998) Management and culture: The third age of safety. In: A.M. Feyer and A. Williamson (Eds.) "Occupational injury: Risk prevention and intervention". London: Taylor and Francis.
- Health and Safety Executive (2005) "A review of safety culture and safety climate literature for the development of the safety culture inspection toolkit." HSE Books.
- Hopkins, A (2005) "Safety, Culture and Risk: The Organisational Causes of Disasters." Sydney: CCH.
- Hrebiniak, L G (2006) Obstacles to effective strategy implementation. "Organizational Dynamics", 35(1), 12-31.
- Hudson, P (2007) Implementing a safety culture in a major multi-national. "Safety Science". 45(6), 697-722.
- IAEA (1986) "Summary Report on the Post-Accident Review Meeting on the Chernobyl Accident International Safety Advisory Group, Safety Series 75-INSAG-1". Vienna: International Atomic Energy Agency.
- Johnson, G, Scholes, K and Whittington, R (2008) "Exploring Corporate Strategy." 8ed. Harlow, England: Prentice Hall.

- Kaplan, R S and Norton, D P (1996) Using the balanced scorecard as a strategic management system. "Harvard Business Review", Jan-Feb, 75-85.
- Kirkpatrick, D L (1979) Techniques for evaluating training programs. "Training and Development Journal", June, 178-192.
- Knowles, M S (1980) "The Modern Practice of Adult Education: From Pedagogy to Andragogy." New York: Cambridge.
- Lend Lease (2014). <http://lendlease.com/> (18 Feb 2014).
- Lingard, H and Rowlinson, S (2005) "Occupational Health and Safety in Construction Project Management." Oxon: Spon Press.
- McGeorge, D and Zou, P X W (2013) "Construction Management: New Directions." 3ed. Chichester, UK: Wiley.
- Pidgeon, N (1998) Safety culture: Key theoretical issues. "Work & Stress", 12(3), 202-216.
- Price, A D F and Newson, E (2003) Strategic management: Consideration of paradoxes, processes, and associated concepts as applied to construction. "Journal of Management in Engineering", 19(4), 183-192.
- Reason, J (2000) Safety paradoxes and safety culture. "Injury Control and Safety Promotion", 7(1), 3-14.
- Sun, A C S and Zou, P X W (2010) Understanding the true costs of construction accidents. "CIB World Congress", 11-13 May, Salford Manchester UK.
- Sunindijo RY and Zou, P X W (2013) Aligning safety policy development, learning and implementation: From boardroom to site. "CIB World Congress", 5-9 May, Brisbane, Australia.
- Tsoukas, H and Mylonopoulos, N (2004) Introduction: Knowledge construction and creation in organizations. "British Journal of Management", 15(S1), S1-S8.
- Weinstein, M, Gambatese, J, and Hecker, S (2005) Can design improve construction safety?: Assessing the impact of a collaborative safety-in-design process. "Journal of Construction Engineering and Management", 131(10), 1125-1134.
- Zou, P X W, Redman, S and Windon, S (2008) Case studies on risk and opportunity at design stage of building projects in Australia: Focus on safety. "Architectural Engineering and Design Management", 4(3-4), 221-238.
- Zou, P X W, Sun, A C S, Long, B and Marix-Evans, P (2010). Return on investment of safety risk management system in construction. "CIB World Congress", 11-13 May, Salford Manchester UK.
- Zou, P X W and Sunindijo, R Y (2013) Skills for managing construction safety risks, implementing safety tasks and developing positive safety climate. "Automation in Construction", 34, 92-100.
- Zou P X W, Windon S and Mahmud S H (2006) Culture change towards construction safety risks, incidences and injuries: Literature review and case study, "CIB W099 International Conference", 28-30 June, Beijing, China.

TAKING STOCK OF ZERO HARM: A REVIEW OF CONTEMPORARY HEALTH AND SAFETY MANAGEMENT IN CONSTRUCTION

Manikam Pillay⁸

¹ School of Exercise and Health Sciences, Edith Cowan University, Joondalup, Western Australia 6027

Achieving the goal of zero harm requires construction organizations to effectively manage the health and safety risks associated with their operations in an effective manner. From an Australian perspective, the reductions in number of accidents and injuries experienced by construction sector in the last ten years are an indication of some level of success, at least in some parts of the industry. However, serious injuries and deaths continue to be reported, suggesting many in the sector are not learning from the emerging theory associated with accident causation and health and safety management. The purpose of this paper is to review our current understanding of how accidents are caused and how they can be prevented, revisits some of the contemporary theories and models that have been used to inform health and safety management practice, and outlines some of their limitations. The paper concludes with a number of ideas and suggestions those charged with managing health and safety in the construction sector may want to think about as they pursue their journey towards zero harm.

Keywords: contemporary health and safety management, eras of safety, dominoes theory, behaviour-based safety, human error

INTRODUCTION

Achieving sustainable levels of health and safety performance remains a key challenge for both developing and developed nations as they struggle to deal with the high economic and social costs of work-related injuries, illnesses and deaths. Australia is no exception with the most recent statistics suggesting the cost of work-related fatalities and injuries exceeded \$60B, representing 4.8% of Gross Domestic Product (Safe Work Australia, 2012). These costs are expected to increase due to a wide range of factors such as the fast pace of changes at work, advances in technology and organizational systems, changing nature of hazards and risks, emerging hazards, introduction of new regulations increasing complexity of organizations (Leveson, Dulac, Marais, & Carroll, 2009; Pillay, 2013b) and ageing of the construction workforce. Nowhere are the impacts of these effects likely to be more pronounced than in an industry such as construction which continues to be recognized as one of the most dangerous and hazardous for workers. Incidence rates for the Australian construction industry for the last decade are illustrated in Figure 1. A cursory glance would seem to suggest there have been improvements in this performance over the decade; however the fact that the incidence rate remains very high at 17.8 per 1000 employees, the fourth most dangerous industry for workers. This is clearly

⁸ m.pillay@ecu.edu.au

unacceptable and a significant cause for concern to the government, employees and the public.

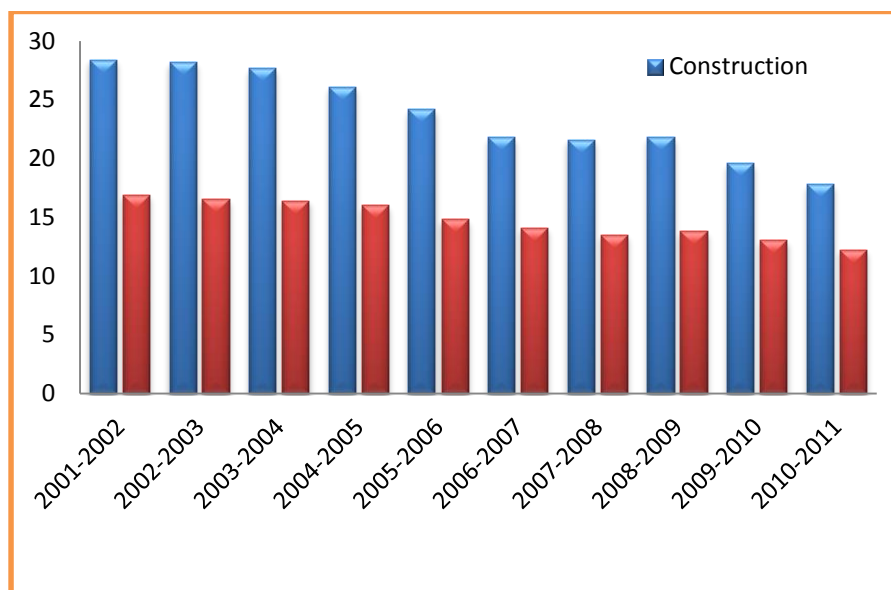

Figure 1: Construction industry incidence rates, Australia 2001-2011 (Pillay, 2013b)

In the view of the author, one reason for the continued poor health and safety performance of the industry could be that current strategies for managing health and safety in the industry has not kept pace with emerging theory associated with the literature on accident causation and safety management literature. Hollnagel made a similar observation when he argued that the approaches and methods used were between two and four decades old and while they may have been useful at a particular point in time, their ability to deal with current safety issues amidst an environment of uncertainty and complexity were questionable (Hollnagel, 2007). This argument can be extended to the construction industry which has been suggested to be a complex one (Du & El-Gafy, 2010). Hence there is a need to look for newer ideas and solutions. Doing this, however, will not be complete without first gaining a nuanced understanding of the current strategies for managing health and safety, the assumptions and premises on which these assumptions are based upon, and their limitations. This paper aims to do this through a review of the published literature on health and safety management, through a scheme known as the eras of safety.

EVOLUTION OF HEALTH AND SAFETY MANAGEMENT

Approaches to health safety management has been suggested to have evolved over five eras (Pillay, Borys, Else, & Tuck, 2010), illustrated in Figure 2. The first involved technological; while the second represented behavioral and human factors. These two are representatives of contemporary approaches (Pillay & Tuck, 2012). The third involved the socio-technical, while the fourth represented more advanced ways approaches (Pillay, 2013a; Pillay & Tuck, 2012). The fifth, which is associated with adaptation (Borys, Else, & Leggett, 2009) or resilience (Pillay et al., 2010) and represents a more sophisticated strategy (Pillay, 2013b). In the rest of the paper the contemporary strategies for managing health and safety are reviewed and examined. This is because a recent review suggests that most of the published research on

construction safety has primarily focused on behaviours (Bhattacharjee, Ghosh, & Young-Corbett, 2011).

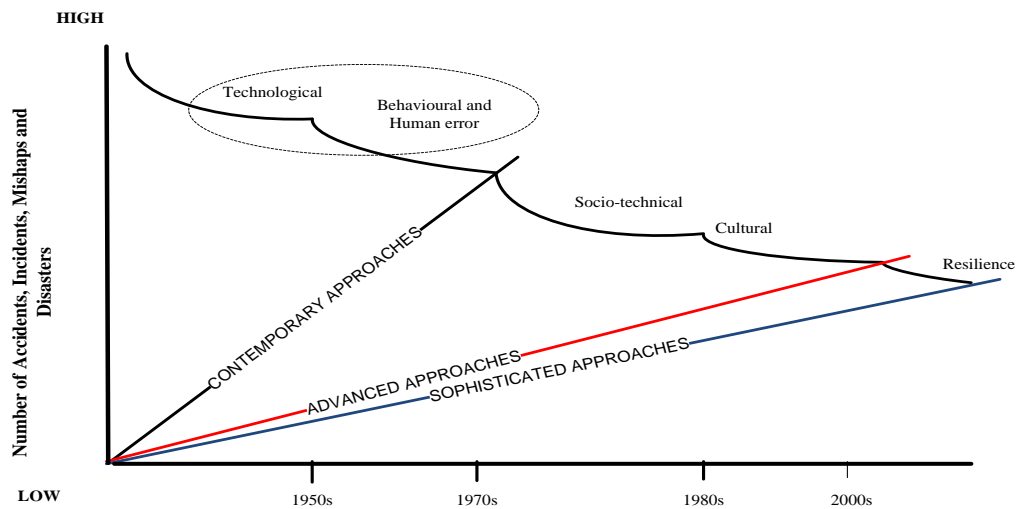

Figure 2: Evolution of health and safety management strategies (Adapted from Pillay et al. (2010)).

CONTEMPORARY HEALTH AND SAFETY MANAGEMENT

Contemporary strategies were based on primarily two approaches. The first involved technological which was marked by rapid developments and improvement in mechanical systems. Accidents and incidents were attributed to failures in structural design and mechanical faults, and the main ways of dealing with these were by establishing highly prescriptive rules, regulations and standards. The second involved behaviours and human error, the argument being that if the rules, standards and regulations were okay, it was necessary to ensure people followed them in order to be safe. The three most common ways of health and safety management were based on Dominoes, Human Factors and Accident/Incidents theories.

Dominoes theory

The Dominoes theory of accidents was first suggested by Herbert Heinrich. According to the author, accidents resulted from a chain of events, similar to a line of dominoes falling over. If the first domino fell over, this impacted the next domino causing it to fall, eventually resulting in an accident. Heinrich's theory included five dominoes which can be summarized as (i) ancestry and social environment; (ii) fault of person (which made them cause unsafe acts or create unsafe conditions); (iii) unsafe act/mechanical or physical hazard (which were the direct cause of accidents); and (v) injury (Heinrich, Petersen, & Roos, 1980). Other researchers such as Bird and Germain (1986) and Vincoli (1994) updated the dominoes theory further by introducing two new concepts; (i) the influence of management and managerial error, and (ii) losses arising from an accident/incident which included any of production, property damage, wastage of other assets and injuries. These saw the five dominos being relabeled as (i) lack of control; (ii) basic causes; (iii) immediate causes; (iv) incident; and (v) loss to people or property. According to this theory, all accidents and incidents were the result of basic causes and which could be grouped into two main

classifications: personnel and job factors. Personnel Factors, which included things such as (i) lack of understanding or ability, (ii) improper motivation (or bad attitude, and (iii) illness, mental, or personal, revealed why some people were more likely to engage in substandard practices (the third domino or Heinrich's "unsafe acts"). Job Factors, which included things such as (i) inadequate work, (ii) inadequate design or maintenance, (iii) low quality equipment, and (iv) normal or abnormal wear and tear; revealed why "substandard conditions" (or Heinrich's 'unsafe conditions') existed in the first place. The unsafe acts and conditions in Domino 3 were similar to Heinrich. However, unlike Heinrich, the authors suggested these merely represented the symptoms of root causes associated with the first two dominoes. This approach was slightly different from Heinrich, who felt the first two dominoes combined to produce the third. This revised theory appears to be among one of the first to postulate that it was essentially the lack of control by management that began the process that eventually caused incidents; stressing that if management carried out their basic functions of planning, organizing, leading, and controlling well, then all the necessary goals (such as safety, quality, production or cost) of an organization could be achieved (Vincoli, 1994). Vincoli did not distinguish between any levels of management, arguing that irrespective of where they were in the management hierarchy they were still responsible for the four basic functions expected of any managers; in an organizational environment where management allowed the symptoms to continue unchecked incidents were more likely to occur.

The two forms of dominoes theories illustrated above are examples of what have been described as linear sequential or event-based models of accidents (Leveson, 2004). A limited number of dominoes modeling studies have been undertaken, primarily in the chemical process industries (Delvosalle, Fievez, & Brohez, 2002; Khan & Abbasi, 1998). From an application point of view, Vincoli's approach has been the main source of loss prevention and control approach to risk management in the oil and gas industry.

Assumptions and shortfalls

Whilst the above theories have been very useful in explaining how accidents are caused (hence how they can be prevented), they also have their limitations. In the main they suggest that (i) organizations are linear in structure and the sequence of events leading to injury follows this pattern, and (ii) accidents are caused by single factors. Hence the domino model reinforces a misunderstanding that accidents have a root cause which can be found by searching backwards from event through the chain of causes that preceded it, and that the chain of events occur in a linear fashion (Hollnagel & Woods, 2006). However, reports of organizational disasters suggest these types of accidents are the result of more than one factor. For example, the three mile nuclear meltdown, Columbia and Challenger shuttle disasters pointed towards gradual losses in safety barriers which could not be explained by the linear sequencing of the dominoes theory.

On a more practical level, there are no domino pieces waiting to fall in the world (Hollnagel & Woods, 2006). As the authors posit, "there may be precariously poised systems or subsystems that suddenly change from normal to an abnormal state, but that transition is rarely as simple as a domino falling. Likewise, the linking or coupling between the dominoes is never as simple as the model shows" (Hollnagel & Woods, 2006). Here Hollnagel and Woods are alluding to dominoes being part of an organizational system; in the view of the author this is a more advanced approach to explaining safety.

Human factors theory

The human factors theory is based on one of the dominoes in the original theory, and which has been expanded. The central idea behind the dominoes theory was that people played an important role in the causation of accidents, and this was accepted for many decades. However, it is only in recent years that increased efforts have been devoted to developing a more nuanced understanding of the role human factors played in accident causation and their prevention. The basic premises behind the human factors theory is that although technical and technological advancements brought about significant improvements in terms of production and safety, it also reduced workers skills about the work they were required to do, as well as the time required to do that job; the monotony of their jobs impacted on their attitudes as well as mental well-being, all of which combined together increased ones potential to err (Fuller & Vassie, 2004). So this theory suggested that those accidents were ultimately caused by human error, and which could arise from three broad factors: (i) overload, (ii) inappropriate response and (iii) inappropriate activities (Heinrich et al., 1980). Overload represented an imbalance between a person's capacity (which in turn depended upon one's natural ability, training, state of mind, fatigue, stress and physical condition); the load comprised of the tasks he/she was responsible for, and the added burdens arising from environmental factors (such as noise, distractions etc), internal factors (such as personal problems, stress, worry) and situational factors, such as degree of risk, clarity of instructions, etc. (Goetsch, 2005; Heinrich et al., 1980). Workers could often be 'set up to fail' by the way one's brain processes information by our training, through the design of equipment and procedures, and even through the culture of the organization one worked for (Health and Safety Executive, 1999). Moreover, this theory also suggests accidents could be caused (or prevented) by how people responded to any given situation. For example, if one saw a hazardous condition or threat but does not correct or report it, he/she has responded inappropriately. Similarly, removing guards from a exposed piece of machine without replacing, fixing or locking/tagging it out is inappropriate, as is ignoring safety procedures and rules that have been provided for their use. Some people could also make catastrophic decisions even when they are aware of the risks (Health and Safety Executive, 1999). Inappropriate activities included things such as performing a task without the necessary training, or misjudging.

Some of these basic ideas arising from human factors theory have been substantially developed into specific bodies of knowledge such as behavior-based safety (BBS) and human error. Sense-making, which is associated with high-reliability and resilience and part of the more advanced and sophisticated approaches, also has its roots in situation factor analysis and logic in decision-making.

Behavior-based safety

The behavioral theory of accident causation and prevention is often referred to as behavior-based safety (BBS), the key proponent of which included psychologist Scott Geller and his colleagues. Since its introduction in the mid - 1970s, BBS has undergone a series of evolutionary changes. The first, which was popular in the early 1970s to mid-1980s, largely entailed a supervisory, top-down-driven process where supervisors observed worker behavior, gave feedback and provided some form of positive or negative reinforcement. Improvements and initiatives aimed at participation and consultation saw employee-led processes in the early-1980s with

employees being involved in the development of the overall process, conduct of peer-to-peer or workgroup-based observations and providing feedback (Hopkins, 2006). However, this excluded management leading to the common perception that behavioral safety processes focus solely on employee behaviors. Employees monitored behavior of members of their work-groups, while managers monitored their own safety-related leadership behaviors. Everyone involved received regular feedback, with some also receiving tangible reinforces or incentives. Surveys of organizations using BBS suggest all three approaches are widely used around the world (Cooper, 2009).

Assumptions and shortfalls

BBS approaches for safety management has one central assumption; that people are the sole cause of all accidents. Hence controlling people's behavior was the main way of reducing accidents. However, as discussed previously, most accidents can be attributed to a number of factors. BBS also has a number of disadvantages, including:

- it blurs the focus of loss prevention efforts;
- focuses on behaviour while problema could lie with values and/or attitudes;
- denies the importance of power;
- manipulates people and treats them like children;
- masks the root cause(s) of unsafe behaviours;
- isolates (instead of integrating) safety into the management process (Geller 2005).

Human error

The term 'human error' has been associated with a wide range of human behavior. According to Reason it was a "generic term to encompass all those occasions in which a planned sequence of mental or physical activities fails to achieve its intended outcome, and when these failures cannot be attributed to the intervention of some chance agency" (Reason, 1990). Over the last three decades there human error has been the subject of significant research and this has given us a greater insight into the different causes of human failure. Figure 3 includes one illustration that has been synthesized by the Health and Safety Executive (1999) to explain the links between human failures, errors and violations.

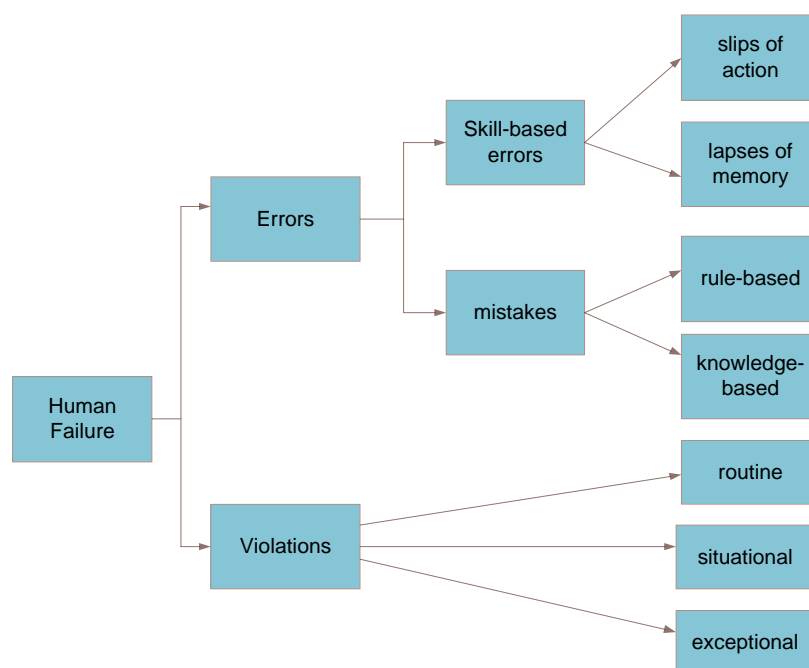

Figure 3: Sources of human failures (Health and Safety Executive, 1999)

Assumptions and shortfalls

The key assumptions behind human factors theory, which has been suggested to represent the 'old view of human errors' are that (i) human error is the cause of most accidents, (ii) the engineered systems in which people work are designed to be intrinsically safe with the main threat to it arising from inherently unreliable people, and (iii) safety can be achieved by protecting the system from unreliable systems through selection, procedures and standardization, automation and training (Dekker, 2002). However, as authors such as Shappell and Weigman (2001) suggest, simply writing off accidents merely to human error is an overly simplistic, if not naïve, approach, since it is well established that accidents cannot be attributed to a single cause, or, in most instances, even a single individual. Moreover, work from the high-risk domain such as healthcare suggests that

- defining error-as-cause blocks learning by masking more prominent factors that affect human and system performance since knowledge and error flow from the same mental sources and it is only a successful outcome that distinguishes one from the other,
- defining error-as-consequence is redundant and confusing, and using error as a synonym for harm gave a false sense of feeling that there is progress being made when there may be none, and
- defining error-as-deviation from a model of 'good' process collides with the problem of multiple standards (Woods & Cook, 2004).

Accident/incident theory

The accident/incident theory is basically an extension of the human factors theory and incorporates knowledge of both human-machine compatibilities and interactions, and organisational systems (Goetsch, 2005; Heinrich et al., 1980). This theory retains most of the original ideas associated with human factors theory, but also introduces

new ideas such as ergonomic traps, decision to err and systems failures (Goetsch, 2005; Heinrich et al., 1980). Ergonomics is about the compatibility of the man-machine interface, and the decision to err could be due to risk of task being misjudged, unconscious or deliberate attempt to err, depending on the situation as presented, while pressures, fatigue, motivation, drugs, alcohol and worry could all cause overload and unsafe behavior amongst workers (Goetsch, 2005; Heinrich et al., 1980).

One of the most important contributions from this theory involved the introduction of a 'systems' element by showing the potential for a causal relationship between management behaviors and/or decisions and safety, so as to bring to the fore management's role in the causation and prevention of accidents. Management can contribute to failures, for example, by not (i) establishing or implementing a comprehensive safety policy, (ii) clearly defining accountabilities, responsibilities and authorization for safety actions and improvements, (iii) giving adequate attention to measuring, monitoring, investigations and corrective actions, and (iv) adequate induction, site-specific or task specific training and/or development opportunities.

A number of integrated models of accident causation and safety management have been derived from this theory. For example, the introduction of system failures meant the creation of schemes for assessing and classifying accidents and incidents using human factors in industries such as aviation (Shappel & Weigman, 2001). A recent study has seen this approach being applied to the Queensland mining industry (Lenne, Salmon, Liu, & Trotter, 2012). Similarly, the notion of ergonomic traps meant a new body of knowledge on the socio-technical arrangements, while the concept of overloads has seen developments in cognitive systems and sense making as approaches for safety and accident prevention.

DISCUSSION

In this paper it has been argued that approaches to health and safety management involved an evolution that included five eras of strategies ranging from technological, behavioral and human factors, socio-technical, cultural and resilience. The first two of these can be associated with contemporary approaches; with dominoes, human factors and accident/incident theories being the main models for understanding accident causation and their prevention.

A review of the published research suggests there are no studies based on the domino theory from the construction, or any other industry. This is suggestive, perhaps rightly so, that the model itself may not be a good way forward for the industry. BBS, on the other hand, is the subject of many research publications. The behavioral safety group, an international body that advocates and assists organizations implement such approaches in industry have argued successful results of interventions include 40-75% reductions in accidents over six to twelve months of implementation (Behavioural-safety, 1999). Fleming and Lardner (1999) evaluated four BBS programs in the oil and gas industry and found interventions aimed at addressing behaviors were perceived to have a positive influence on the participants, although only one of the four case studies could demonstrate an improvements in accident rates. There have also been claims that BBS has been successfully implemented in industries such as manufacturing, hence can be replicated in construction (Emerging Construction Technologies, 2002). A review by Bhattacharjee et al. (2011) found that cultural approaches to improving safety in the industry were predominantly aimed at dealing

with (subcontractor) behaviors. However, research on the success or otherwise of BBS approaches in the industry itself are lacking, and this is one area whether further research may be warranted.

The common theme between the two contemporary approaches is based around human failures, through errors and violations. However as the accident/incident theory suggests, there are many other factors that could contribute to these failures. In the main it can be suggested that all the different factors and contributors to workplace accidents are about a significantly large number of dominoes but arranged in a more complex and multiple sequencing, instead of in a simple and single, linear sequence suggested by Heinrich. This is not to say there will not be any linear sequence, as is evident in Figure 4 the integration of the theories suggests there may be a number of linear sequencing of causative factors that may impact some aspect of an organization, and therefore safety in the organization.

On a more pragmatic level, this review has highlighted that understanding accident prevention and safety management involves going beyond the facades of organization to look deeper at social, technical and human elements that make up an organization; dominoes that were indirectly identified as early as the 1930s.

CONCLUSIONS

Contemporary approaches have been widely used for managing health and safety in traditional industries such as construction, and some of the specific approaches that form part of these approaches have been briefly reviewed in this article. Each of them has a number of advantages, as well as disadvantages. The key assumption behind these approaches is that organisations are simple and linear in structure, and that incidents occur in a similar sequential fashion. Some reference is made to systems; however, by far they extend this linear thinking to organisations as well. This review contributes to the literature on construction health and safety management the utility of contemporary health and safety management strategies, the key assumptions on which they are based, and their limitations. As has been discussed at a number of different points of this review, incidents can be caused by other organizational, technical and social factors as well, which points towards a need to extend our thinking beyond contemporary safety to thinking about how these can be integrated into a socio-technical understanding of accidents. According to the scheme presented in Figure 2, this represents a more advanced approach to health, and which will be the subject of a future review paper.

ACKNOWLEDGMENTS

The author wishes to acknowledge the assistance of the two anonymous referees whose comments helped in refining this paper.

REFERENCES

- Behavioural-safety. (1999). Retrieved from <http://www.behavioural-safety.com/au>
- Bhattacharjee, S., Ghosh, S., & Young-Corbett, D. (2011). *Safety improvement approaches in construction industry: A review and future directions*. Paper presented at the 47th ASC International Conference.

- Bird, F.E., & Germain, G.L. (1986). *Practical loss control leadership*. Loganville, Georgia: International Loss Control Institute.
- Borys, D.M., Else, D., & Leggett, S. (2009). The fifth age of safety: The adaptive age. *J Health & Safety Research & Practice*, 1(1), 19-27.
- Cooper, D. (2009). Behavioral safety interventions: A review of process design factors. *Professional Safety*, February, 36-45.
- Dekker, S.W.A. (2002). Reconstructing human contributions to accidents: The new view on error and performance. *Journal of Safety Research*, 33, 371-385.
- Delvosalle, C., Fievez, C., & Brohez, A. (2002). *A methodology and a software (dominoxl) for studying domino effects*. Paper presented at the 15th International Congress of Chemical and Process Engineering, Prague.
- Du, J., & El-Gafy, M. (2010). *Examining complex systems and agent-based modeling for improving decision makings in construction organisations*. Paper presented at the CIB W78: 27th international Conference, Cairo, Egypt.
- Emerging Construction Technologies. (2002). Behaviour-based safety in construction. from <http://www.new-technologies.org/ECT/safety/behaviorsafety.htm>
- Fleming, M., & Lardner, R. (1999). Behaviour modification programmes - establishing best practice. Edinburgh: The Keil Centre.
- Fuller, C.W., & Vassie, L.H. (2004). *Health and safety management: Principles and best practice*. Essex, England: Pearson Education Limited.
- Geller, E.S. (2005). Behaviour-based safety and occupational risk management. *Behaviour Modification*, 29(3), 539-561. doi: 10.1177/0145445504273287
- Goetsch, D.L. (2005). *Occupational health and safety for technologists, engineers and managers* (5th ed.). Canada: Pearson Education.
- Health and Safety Executive. (1999). *Reducing error and influencing behaviour*. London: HSE Books.
- Heinrich, H.W., Petersen, D., & Roos, N.R. (1980). *Industrial accident prevention: A safety management approach* (5th ed.). New York: McGraw-Hill.
- Hollnagel, E. (2007). Why do we need resilience engineering.
<http://sites.google.com/site/erikhollnagel2/whatisresilienceengineering%3F>
- Hollnagel, E., & Woods, D.D. (2006). Epilogue: Resilience engineering precepts. In E. Hollnagel, D. D. Woods & N. G. Leveson (Eds.), *Resilience engineering: Concepts and precepts* (pp. 347-358). Aldershot: Ashgate.
- Hopkins, A. (2006). What are we to make of safe behaviour programs? . *Safety Science*, 44(7), 583-597. doi: 10.1016/j.ssci.2006.01.001
- Khan, F.L., & Abbasi, S.A. (1998). Dominofect (domino effect): A new software for domino effect analysis in chemical process industries. *Environment Modelling and Software*, 13, 163-177.
- Lenne, M.G., Salmon, P.A., Liu, C.C., & Trotter, M. (2012). A systems approach to accident causation in mining: An application of the hfacs method. *Accident Analysis and Prevention*, 48, 111-117. doi: 10.1016/j.aap.2011.05.026
- Leveson, N.G. (2004). A new accident model for engineering safer systems. *Safety Science*, 42(4), 237-270.

- Leveson, N.G., Dulac, N., Marais, K., & Carroll, J. (2009). Moving beyond normal accidents and high reliability organizations: A systems approach to safety in complex systems. *Organization Studies*, 30(2), 227-249. doi: 10.1177/0170840608101478
- Pillay, M. (2013a). *Disasters, accidents and safety: A review of theory and applications for advancing mine safety management*. Paper presented at the 35th International Conference of Safety in Mines Research Institutes (ICSMRI 2013), 15-17 October, Central Hall Westminster, London.
- Pillay, M. (2013b). *Exploring resilience engineering through the prescription and practice of safe work method statements in the victorian construction industry*. (PhD), University of Ballarat, Ballarat.
- Pillay, M., Borys, D., Else, D., & Tuck, M. (2010). Safety culture and resilience engineering: Theory and application in improving gold mining safety. In S. Dominy (Ed.), *Gravity Gold 2010* (pp. 129-140). Melbourne, Australia: AusIMM.
- Pillay, M., & Tuck, M. (2012). *Revisiting occupational health and safety management in mining: Towards new ways of thinking*. Paper presented at the The AusIMM New Leaders Conference, 2-3 October, Ballarat.
- Reason, J. (1990). *Human error*. Cambridge: Cambridge University Press.
- Safe Work Australia. (2012). *The cost of work-related injury and illness for Australian employers, workers and the community, 2008-2009*. Canberra: Safe Work Australia.
- Shappel, S.A., & Weigman, D.A. (2001). Applying reason: The human factors analysis and classification system (hfacs). *Human Factors and Aerospace Safety*, 1(1), 59-86.
- Vincoli, J.W. (1994). *Basic guide to accident investigation and loss control*. New York: Wiley & Sons.
- Woods, D.D., & Cook, R.I. (2004). Mistaking error. In B. J. Youngberg & M. J. Haitely (Eds.), *The patient safety handbook* (pp. 95-108). Missisaunga, Canada.: Jones and Bartlett Publishers.

PROGRESSING ZERO HARM: A REVIEW OF THEORY AND APPLICATIONS FOR ADVANCING HEALTH AND SAFETY MANAGEMENT IN CONSTRUCTION

Manikam Pillay⁹

¹ School of Exercise and Health Sciences, Edith Cowan University, Joondalup, Western Australia 6027

Progressing towards the goal of zero harm is an important part of achieving sustainable health and safety performance in construction. In Australia there are some indications that progress is being made in terms of improvements in health and safety performance in some parts of the industry. However, serious injuries and deaths continue to be reported, suggesting many in the sector are not learning from the emerging theory associated with advanced approaches for accident prevention and safety management. The purpose of this paper is to review such advanced approaches. Drawing on health and safety management research in highly hazardous and complex operations such as nuclear, aviation and healthcare, two new theories, normal accidents and high-reliability, are introduced and reviewed as advanced approaches for managing health and safety. NAT research conducted in oil and gas industry suggests that reductions, downsizing and budget cuts contributed to tighter coupling hence increased the risk of normal accidents. Construction, however, is a more loosely-coupled system, and paying attention and dealing with weak signals of failure can be a pragmatic way of reducing normal accidents. HRO theorists point towards the development of collective mindfulness which is demonstrated through a pre-occupation of failure, a reluctance to simplify operations, a commitment to resilience, being sensitive to operations, and deferring decisions to groups or people with the most expertise irrespective of where they were in the chain of command. While debates surrounding the utility of NAT and HRO are necessary and will continue, those charged with managing health and safety in construction sector may want to use some of the concepts and ideas as a way of progressing towards zero harm.

Keywords: advanced health and safety management, complexity, normal accidents, high-reliability, loose-coupling

INTRODUCTION

Achieving sustainable levels of health and safety performance remains a key challenge worldwide as nations seek to grapple with the high economic and social costs of work-related injuries, illnesses and fatalities. The construction industry remains at the forefront of these challenges because it is generally regarded as one of the most dangerous due to its poor safety performance (Pillay, 2013c; Zolfagharian, Ressang, Irizarry, Nourbaksh, & Zin, 2011). From an Australian perspective there have been some improvements (as measured in terms of reductions in the number of fatalities and incidence rates) over the last decade (Pillay, 2013b). Internationally, a strategy of zero accidents has been suggested to be a way forward (Farooqui, 2011; Zwetsloot et al., 2013); while in Australia many companies are embracing the notion

⁹ m.pillay@ecu.edu.au

of zero harm in high risk industries such as mining (Head, 2012). It is possible this policy adopted by construction companies has played a role in driving some of these improvements. However, serious injuries and deaths continue to be reported, and the industry continues to remain the fourth most dangerous industry for worker (Safe Work Australia, 2012). One of the main reasons behind the continued poor health and safety performance of the construction industry could be that current strategies being used for managing health and safety have not kept pace with emerging theory associated with accident causation and health and safety management. According to Hollnagel (2007), such strategies, which were between twenty and forty years old and were useful at that particular point in time, were outdated and not capable of addressing safety issues in the current period of uncertainty and complexity. This necessitates the need for more innovation. However, before this can be done one needs to be cognizant of some of the emergent approaches and strategies for managing health and safety. This paper seeks to achieve this through a review of evolution of health and safety management strategies through a scheme of the ages of safety.

EVOLUTION OF HEALTH AND SAFETY MANAGEMENT

Approaches to managing health safety have been suggested to have evolved over five ages of safety (Pillay, Borys, Else, & Tuck, 2010). The first, from the nineteenth century to the end of World War II, represented technical; the second, between the two World Wars to the 1970s represented human errors; the third, between the 1970's to the 1980's, involved the socio-technical, while the fourth, from the 1980's, entailed culture; while the fifth, from the early 2000's, is associated with adaptive (Borys, Else, & Leggett, 2009) or resilience (Pillay et al., 2010). The first two can be associated with contemporary health and safety management, with Dominoes, human factors, behavior-based safety, human-error and accident/incident theories being among those most used to explain health and safety management (Pillay & Tuck, 2012). The key assumption behind these approaches is that organisations are simple and linear in structure, and that incidents occur in a similar sequential fashion. Accidents, however, can also be caused by other organizational, technical and social factors as well, which means we need to extend our thinking beyond contemporary safety to thinking about how these can be integrated into a socio-technical understanding of accidents. This involves more advanced approaches (Pillay & Tuck, 2012).

ADVANCED APPROACHES FOR MANAGING HEALTH AND SAFETY

Advanced approaches for managing safety management includes socio-technical and cultural approaches. The former is built on the premise that organisational effectiveness depended on optimising the human (social) and mechanical (technological) capability of organisations. The initial research in this area was carried out by the Tavistock Institute in the mining industry and focussed on the effectiveness of long-wall mining work-groups operating as semi-autonomous teams (Trist, 1981; Trist & Bamforth, 1951). The original ideas of socio-technical system of works were based around job design and later expanded to incorporate the best man-machine fit. The discipline of Ergonomics can be best associated with these approaches, and the Swiss-cheese model (Reason, 1997) was a useful way of explaining how major and/or organisational accidents were most likely to occur.

Apart from safe design, the advanced approach also involves culture; originally identified as an important factor in the Three Mile Island nuclear disaster but has since been associated with a number of organisational accidents such as Piper Alpha and Challenger (Pillay, 2013a). Many organisations are embracing the cultural approach to safety, with a number of being published from the construction domain (Benford Jr, 2008; Biggs, Sheahan, & Dingsdag, 2005; Cheng, Ryan, & Kelly, 2012; Choudhry, Fang, & Mohamed, 2007). A recent review, however, refutes the utility of safety culture as currently adopted in the construction industry and argues instead for the adoption of Prevention through Design (PtD) as a better way forward (Bhattacharjee, Ghosh, & Young-Corbett, 2011). From an application point of view PtD is but an extension of the ergonomics approach.

However, there are a number of other approaches that form part of the advanced ways of managing health and safety. Two of these include the normal accident theory and high-reliability theory, and the remainder of this paper concentrates on these.

Normal accident theory

Normal accident theory (NAT) was first conceptualised by Charles Perrow in the aftermath of the Three Mile Island in 1979, as he sought to provide an alternative explanation of how such accidents are caused in organisations which were highly technologically advanced. He argued that as organisations developed technologically, the processes and systems required to run them efficiently became increasingly complex (Perrow, 1999). He identified two distinct dimensions based on interactions in the organizational structure and coupling between the systems components involved in the processes used in the organization. According to his typology interactions in the organizational structure could range along a continuum of linear to complex, while couplings between the system elements could be loose or tight. Complex interactions, according to Perrow (1999), occurred in unfamiliar, unplanned and unexpected sequences, and were either not visible or not immediately comprehensible. Some of the factors he identified that made interactions complex included (i) presence of components that had multiple functions which meant they could fail in many directions at once; (ii) physical proximity of components; (iii) a silo mentality of teams created by specialized knowledge of personnel which limited their awareness of the different interdependencies; and (iv) multiple control parameters with potential interactions. Organisational systems, according to Perrow (1994) were likely to become tightly coupled when (i) there was minimal time lag between the processes it executed; (ii) the sequence of processing did not vary; (iii) only one method being used and/or available to complete a task; (iv) little slack in supplies, equipment, and personnel; and (v) in-built buffers and redundancies with little scope of introducing them at a later stage (Perrow, 1999). In these highly interactive complex, tightly coupled systems there was inadequate time and understanding to manage and control failures; even small ones could rapidly escalate to a crisis.

Building on Perrow's work, Sagan (2004) argued that complex organizations were likely to produce accidents even if they were not tightly coupled, because safety goals were routinely bypassed to achieve production and narrow goals. There have been some suggestions that bypassing safety goals, such as routinely choosing to break safety rules to achieve production targets is a common practice in most industries, including construction. Hollnagel calls this the efficiency-thoroughness-trade-offs (ETTO) principle (Hollnagel, 2009), while Woods and Branlat (2011) argued that

achieving safety goals meant workers and managers would need to sacrifice production goals. In other words achieving the goals of safety and production involved a dynamic balancing act. In the case of construction Pillay and Borys (2013) found sacrifices being made, both for and against safety; when employees laying drains continued to work very closely in the vicinity of mobile plant, or when working in adverse weather conditions, as they dealt with everyday hazards and threats.

Over a decade ago, the Institute of Medicine formally declared that ‘to err is human’ (Kohn, Corrigan, & Donaldson, 1999). Human error has also been previously identified as the most likely cause of 80% of industrial accidents. If this proposition were to be accepted, then, in the author’s opinion, accidents are likely to be normal in the construction which has been deemed to be a complex industry (Aickin, Shaw, Blewett, Stiller, & Cox, 2012; Bertelsen & Koskela, 2005; Du & El-Gafy, 2010).

As an advanced approach to managing safety, NAT does have a number of limitations. One, it seeks to explain a very narrow category of accidents, industrial disasters, so it has not been investigated in other contexts. Two, it seeks to address safety in complex industrial contexts such as nuclear power plants, oil refineries and chemical plants. And third, research is limited by a lack of refinement in definition and quantification, a point clearly made by Hopkins (1999) when he argued that ‘ill-defined concepts’ and ‘the absence of criteria for measuring complexity and coupling’ were major limitations of NAT. There has been some progress with regard to the latter, with a few research published in recent years. Wolf (2001), for example, attempted to operationalize NAT in refineries and petrochemical plants. Based on his findings from 36 sites he argued that reductions, downsizing and budget cuts (which are perhaps a feature of most construction companies) reduced resources and contributed to tighter coupling in the industry, and this increased the risk of normal accidents in these types of systems.

Academics and practitioners, in particular those who are entrenched in the empiricist and/or positivist frame of thinking and seek evidence in numbers, would argue the limited number of studies published may not give credibility to NAT. This, in the view of the author, is more of an academic debate that is likely to continue as NAT is challenged, refined and improved. However, from a pragmatic point of view, NAT does offer a number of opportunities that can be implemented, tested, explored and improved upon. First, decentralizing has been suggested to assist organizations cope with complex interactions (Shrivastava, Sonpar, & Pazzaglia, 2009). This is something that can be implemented in large organizations. Secondly, and perhaps more importantly, construction has been suggested to represent more of a loosely-coupled system (Dubois & Gadde, 2002); which, in essence should not stop it from dealing with normal incidents. This can be supported through the argument that loosely coupled systems such as mining should be able to prevent accidents because there is ample slack in the system enabling it to be shielded from escalations (Perrow, 1999). If this is not the case there is need to rethink about the interdependencies between the components that constitute a construction system. And third, paying attention to ‘weak signals’ of failures provided very valuable clues regarding any potential point failure in future, and this could be addressed as part of the organization’s health and safety risk management strategy (Hayes, 2009).

NAT also provides support for the need to set explicit rules and procedures for working, and to deal with violations. However, this approach is somewhat at odds

with the high reliability theory (HRT) which is also part of the advanced approaches for managing health and safety. The next and final section looks at this strategy.

High reliability theory

HRT was developed as an alternative to NAT by researchers at the University of Berkeley, California. Termed High-reliability organizations (HROs), these represent a group of those organizations that were likely to operate with a nearly accident free safety record despite operating in hazardous and complex environments as part of their normal work (La Porte, 1996). The original research on HRO involved three case studies involving nuclear aircraft carriers, nuclear power plants and air traffic centers (Rochlin, 1993; Rochlin, La Porte, & Roberts, 1987; Schulman, Roe, Eeten, & de Bruijne, 2004). The studies revealed that, in these organizations, once a threat to safety became apparent (no matter how faint or distant), they re-ordered and reorganized to deal with the threat head-on.

Other researchers have argued that safety (literally) appeared to be the main value against which all decisions, work practices, ideas and incentives were discussed, and these organizations also displayed (a) very high technical competence throughout the organization, (b) constant search for improvement across a number of different dimensions of reliability, (c) detailed analysis of core events that were precluded from happening, (d) a set of analyzed precursor conditions that could lead to a precluded event, (e) elaborate and developing set of procedures and work practices which were closely linked to ongoing analysis and directed towards avoiding precursor conditions, (f) formal structure of roles, responsibilities, and reporting relationships that could be transformed and reorganized during emergencies of conditions or stress into a decentralized, team-based approach for problem-solving, and (g) a culture of reliability that distributed and instilled values of care and caution, respect for procedures, attentiveness and individual responsibility for promoting safety throughout the organization (Bourier, 2011; Roberts, Bea, & Bartles, 2001).

Weick and Sutcliffe (2001) distilled these capabilities into a state of 'collective mindfulness' in the organizations which are characterized by (i) a pre-occupation with failure, (ii) a reluctance to simplify interpretations, (iii) being sensitive to operations, (iv) a commitment to resilience, and (v) deferring decisions to that group or person who held the necessary expertise, irrespective of their place in the chain of command; abilities which assist HROs discover and manage unexpected events so that large scale disasters do not occur, illustrated in Figure 1.

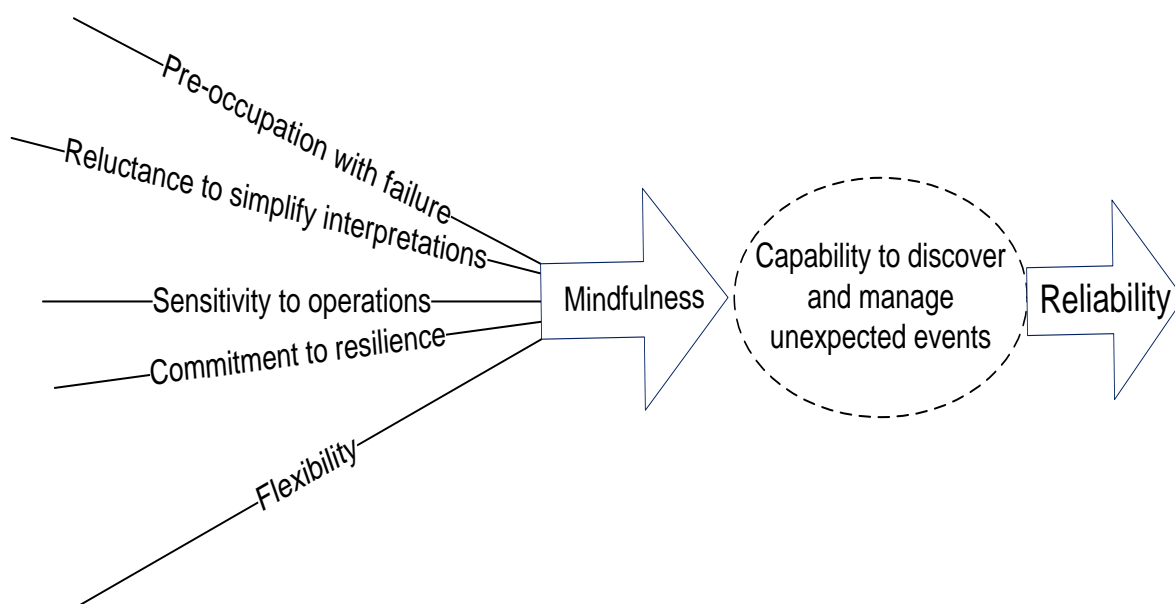

Figure 4: Five core capabilities that drive collective mindfulness in HROs

Unlike NAT, HRT has been the subject of more empirical research, mostly in the healthcare domain. The importance of learning and trust in other roles, sharing responsibilities, team awareness and being adaptive were important in achieving HRO capabilities in trauma resuscitation (Xiao & Moss, 2001), while open communication in helping healthcare organizations become more reliable has also been explored (Frankel, Leonard, & Denham, 2006). Madsen, Desai, Roberts, and Wong (2006) conducted an intervention study where they introduced decentralized decision-making and thereby enabling nurses to carry out tasks traditionally carried out by doctors, and encouraging more open communication through frequent debriefings for all staff following abnormal events. The intervention demonstrated that implementing HRO processes improved response times, quality of patient care while also reducing mortality rates.

The results of this intervention demonstrated that implementing these HRO processes improved response times, quality of patient care while also reducing mortality rates. Outside of the healthcare industry, the application of HRO in the broader Norwegian industry in relation to efficient inspections, feedback for proactive learning, regulatory safety indicators and event reporting has also been investigated (Svenson, salo, Oedewald, Reiman, & Skjerve, 2006). And in Australia series of studies involving air traffic control, nuclear power plant, chemical plants and other ‘high-hazard’ industries have been published (Hopkins, 2009). These studies have looked at issues such as responding to weak signals, use of bow-ties, learning from errors and operational discipline.

At the time that this review was completed, there appears to be one piece of HRO research published from the construction domain. The study by Mitropoulos and Cupido (2009) explored the practices of high-reliability crews (HRC) engaged to undertake framing work in the residential construction industry. The study revealed that the HRCs, in comparison with an average-performing crew, had a strong and clear guiding principle and a set of strategies that focused on preventing errors and

rework. Moreover, these strategies were used both for improving productivity and safety which have traditionally been regarded as incompatible goals, i.e. one cannot be both productive at the same time (Hollnagel, Woods, & Leveson, 2006). While the authors acknowledge their research was based on a comparison of two sites, it does suggest that reliability-enhancing practices could be meaningfully transferred to the construction context.

Similar to NAT, HRT also has its critics, so debates around its usefulness or otherwise will continue to occur as practitioners, governments and policy makers continue to work on finding better and improved ways of addressing zero harm. A compromise between NAT and HRO with integration and systems approach has been suggested as a way forward (Leveson, 2004, 2011; Leveson, Dulac, Marais, & Carroll, 2009). Again, in the view of the author, these are important academic debates to have, but it is more important for the construction industry to pick up on the findings, ideas and concepts and adopt them, test them and improve upon them if further advances have to be made in improving construction health and safety management. Gaining an understanding where a team, department or whole organization is in terms of the five HRO capabilities of mindfulness is a good starting point. In this regard a series of questionnaires, similar to a 'safety audit' or 'climate survey' has been proposed (Weick & Sutcliffe, 2001). An example for assessing an organization's potential towards mindfulness, in the form of a checklist, is illustrated in Table 1. The authors suggest a 3-point Likert scale be used to rate performance. However, it can equally be used to screen for an organizations potential for mindfulness through a simple YES/NO response, by including a greater scale ranging from 1 to 5 or to use these as prompts for semi-structures interviews.

Table 2: Toolkit for exploring high reliability climate

1	There is an organization wide sense of susceptibility to the unexpected.
2	Everyone feels accountable for reliability.
3	Leaders pay as much attention to managing unexpected events as they do to achieving organizational goals.
4	People at all levels of our organization value safety.
5	We spend time identifying how our activities could potentially harm our organization, employees, our customers and other stakeholders.
6	We pay attention to when and why our employees, customers and other stakeholders might feel annoyed or alienated from our organization.
7	There is widespread agreement among organizational members on what we don't want to go wrong.
8	There is widespread agreement among the organization's members about how things could go wrong.

In doing this review it was seen that the toolkit suggested by Weick and Sutcliffe (2001) has not been empirically tested, so there is an opportunity to use this tool to conduct a 'HRO climate/culture survey.'

CONCLUSION

The two advanced approaches to health and safety management can be regarded as innovations. NAT appears not to have been the subject of much empirical research, and construction is an industry where such research could be conducted in. This is because it is widely accepted in the industry that human error is the main cause of most accidents in this industry. If we accept the IOM proposition that 'to err is human', then it is not unreasonable to suggest accidents can be treated as normal events in the industry. NAT thus offers us an opportunity to explore normal accidents in construction. A clearer definition of key concepts such as interactivity and complexity, operationalizing the essential concepts and an identification of both qualitative and quantitative measures of these characteristics in NAT are a good starting point for any empirical research for advancing health and safety management in the construction industry. However, as has been discussed, construction is a more loosely coupled system, so it is possible to use some of the findings from research in other industries to see if it is useful in this context. In the case of HRO a tool for exploring HRO capabilities is already available, and this can be a useful starting point for such a research. However, as discussed, one need not wait for the results of such research, for they are more than likely to generate more debate and calls for further research. Instead, the mindfulness capabilities discussed in section 3.2 can be used as a means of starting their HRO journey. Only can one begin to see actual advances being made in progressing zero harm as a way of achieving sustainable health and safety performance.

ACKNOWLEDGMENTS

The author wishes to acknowledge the assistance of the three anonymous reviewers whose comments helped improve the quality of this paper.

REFERENCES

- Aickin, C., Shaw, A., Blewett, V., Stiller, L., & Cox, S. (2012). Addressing the Cultural Complexity of OHS in the Australian Mining Industry. *Work: A Journal of Prevention, Assessment and Rehabilitation*, 41(1), 4453-4456. doi: 10.3233/WOR-2012-0117-4453
- Benford Jr, C. J. (2008). *Exploratory Study of Construction Safety Culture Through Systems Thinking*. University of Nevada. (UNI Number 1463496)
- Bertelsen, S., & Koskela, L. (2005). *Approches to Managing Complexity in Construction Project Management*. Paper presented at the Becon 2005: the 1st International Conference on Complexity and the Built Bnvironment.
- Bhattacharjee, S., Ghosh, S., & Young-Corbett, D. (2011). *Safety Improvement Approaches in Construction Industry: a Review and Future Directions*. Paper presented at the 47th ASC International Conference.
- Biggs, H. C., Sheahan, V. L., & Dingsdag, D. P. (2005). A Study of Construction Site Safety Culture and Implications for Safe and Responsive Workplaces. *The Australian Journal of Rehabilitation Counselling*, 11(1), 1-8.
- Borys, D. M., Else, D., & Leggett, S. (2009). The Fifth age of Safety: the Adaptive age. *J Health & Safety Research & Practice*, 1(1), 19-27.
- Bourier, M. (2011). The Legacy of the High Reliability Organizations Project. *Journal of Contingencies and Crisis Management*, 19(1), 9-13.

- Cheng, E. W. L., Ryan, N., & Kelly, S. (2012). Exploring the Perceived Influence of Safety Management Practices on Project Performance in the Construction Industry. *Safety Science*, 50(2), 363-369.
- Choudhry, R. M., Fang, D., & Mohamed, S. (2007). Developing a Model of Construction Safety Culture. *Journal of Management in Engineering*, 23, 207-212.
- Du, J., & El-Gafy, M. (2010). *Examining Complex Systems and Agent-based Modeling for Improving Decision Makings in Construction Organisations*. Paper presented at the CIB W78: 27th international Conference, Cairo, Egypt.
- Dubois, A., & Gadde, L.-E. (2002). The Construction Industry as a Loosely Coupled System: Implications for Productivity and Innovation. *Construction Management and Economics*, 20(7), 621-631. doi: 10.1080/01446190210163543
- Farooqui, R. U. H. (2011). *Achieving Zero Accidents: A Strategic Framework for Continuous Safety Improvement in the Construction Industry*. (PhD), Florida International University, Florida.
- Frankel, A. S., Leonard, M. W., & Denham, C. R. (2006). Fair and Just Culture, Team Behaviour, and Leadership Engagement: the Tools to Achieve High Reliability. *Health Services Research*, 41(4 (Part II)), 1690-1709.
- Hayes, J. (2009). Operational Decision-making. In A. Hopkins (Ed.), *Learning From High Reliability Organisations* (pp. 149-178). Sydney: CCH Australia.
- Head, D. (2012). *Exploring the Concept of Zero Harm*. Paper presented at the The AusIMM New Leaders' Conference, Ballarat, Victoria.
- Hollnagel, E. (2007). Why do we Need Resilience Engineering.
<<http://sites.google.com/site/erikhollnagel2/whatisresilienceengineering%3F>
- Hollnagel, E. (2009). *The ETTO Principle: Efficiency-thoroughness Trade-off: why Things That go Right Sometimes go Wrong*. London: Ashgate Publishing.
- Hollnagel, E., Woods, D. D., & Leveson, N. G. (2006). *Resilience Engineering Concepts and Precepts*. Aldershot: Ashgate.
- Hopkins, A. (1999). The Limits of Normal Accident Theory. *Safety Science*, 32(2), 93-102.
- Hopkins, A. (Ed.). (2009). *Learning From High Reliability Organisations*. Sydney: CCH Australia Limited.
- Kohn, L. T., Corrigan, J. M., & Donaldson, M. S. (1999). *To err is Human: Building a Safer Health System*. Washington, D.C: Institute of Medicine.
- La Porte, T. R. (1996). High Reliability Organizations: Unlikely, Demanding and at Risk. *Journal of Contingencies and Crisis Management*, 4(2), 60-71.
- Leveson, N. G. (2004). A New Accident Model for Engineering Safer Systems. *Safety Science*, 42(4), 237-270.
- Leveson, N. G. (2011). Applying Systems Thinking to Analyze and Learn From Events. *Safety Science*, 49(1), 55-64. doi: 10.1016/j.ssci.2009.12.021
- Leveson, N. G., Dulac, N., Marais, K., & Carroll, J. (2009). Moving Beyond Normal Accidents and High Reliability Organizations: A Systems Approach to Safety in Complex Systems. *Organization Studies*, 30(2), 227-249. doi: 10.1177/0170840608101478
- Madsen, P., Desai, V., Roberts, K. H., & Wong, D. (2006). Mitigating Hazards Through Continuing Design: the Birth of a Paediatric Intensive Care Unit. *Organization Science*, 17(2), 239-248.

- Mitropoulos, P., & Cupido, G. (2009). Safety as an Emergent Property: Investigation Into the Work Practices of High-Reliability Framing Crews *Journal of Construction Engineering and Management*, 135(5), 407-415.
- Perrow, C. (1999). *Normal Accidents. Living With High Risk Technology* (2 ed.). Princeton, NJ.: Princeton University Press.
- Pillay, M. (2013a). *Disasters, Accidents and Safety: a Review of Theory and Applications for Advancing Mine Safety Management*. Paper presented at the 35th International Conference of Safety in Mines Research Institutes (ICSMRI 2013), 15-17 October, Central Hall Westminster, London.
- Pillay, M. (2013b). *Exploring Resilience Engineering Through the Prescription and Practice of Safe Work Method Statements in the Victorian Construction Industry*. (PhD), University of Ballarat, Ballarat.
- Pillay, M. (2013c). *Towards and Exploration of Safe Work Method Statements as a Safety Management Strategy in Construction: Background and Theory*. Paper presented at the Seventh International Conference on Construction in the 21st Century (CITC-VII), 19-21 Dec, Bangkok, Thailand.
- Pillay, M., & Borys, D. (2013). *Episodic Adaptations and Trade-offs: Examples From the Victorian Construction*. Paper presented at the 5th International Symposium on Resilience Engineering Soesterberg, the Netherlands.
- Pillay, M., Borys, D., Else, D., & Tuck, M. (2010). Safety Culture and Resilience Engineering: Theory and Application in Improving Gold Mining Safety. In S. Dominy (Ed.), *Gravity Gold 2010* (pp. 129-140). Melbourne, Australia: AusIMM.
- Pillay, M., & Tuck, M. (2012). *Revisiting Occupational Health and Safety Management in Mining: Towards New Ways of Thinking*. Paper presented at the The AusIMM New Leaders Conference, 2-3 October, Ballarat.
- Reason, J. (1997). *Managing the Risks of Organizational Accidents*. Aldershot: Ashgate.
- Roberts, K. H., Bea, R. G., & Bartles, D. L. (2001). Must Accidents Happen? Lessons from High-Reliability Organizations. *The Academy of Management Executive*, 15(3), 70-79.
- Rochlin, G. I. (1993). Defining 'High Reliability Organizations in Practice: a Taxonomic Prologue. In K. H. Roberts (Ed.), *New Challenges in Understanding Organizations* (pp. 11-32). New York: MacMillan Publishing Company.
- Rochlin, G. I., La Porte, T. R., & Roberts, K. (1987). The Self-Designing High Reliability Organization. *Naval War College Review*, Autumn.
- Safe Work Australia. (2012). *Compendium of Workers' Compensation Statistics, Australia 2009-10*. Canberra: Safe Work Australia.
- Sagan, S. (2004). Learning From Normal Accidents. *Organization & Environment*, 17(1), 15. doi: 10.1177/1086026603262029
- Schulman, P. R., Roe, E., Eeten, M. V., & de Bruijne, M. (2004). High Reliability and the Management of Critical Infrastructures. *Journal of Contingencies and Crisis Management*, 12(1), 14-2008.
- Shrivastava, S., Sonpar, K., & Pazzaglia, F. (2009). Normal Accident Theory Versus High Reliability: a Resolution and Call for an Open Systems View of Accidents. *Human Relations*, 62(9), 1357-1391. doi: 10.1177/0018726709339117

- Svenson, O., salo, I., Oedewald, P., Reiman, T., & Skjerve, A. B. (2006). *Nordic Perspectives on Safety management in High Reliability Organizations: Theory and Applications*. Stockholm, Sweden: Department of Psychology, Stockholm University.
- Trist, E. L. (1981). *The Evolution of Socio-technical Systems: a Conceptual Framework and Action Research Program Occasional paper No. 2* (pp. 1-67). Ontario, Canada: Ontario Quality of Working Life Centre,.
- Trist, E. L., & Bamforth, K. W. (1951). Some Social and Psychological Consequences of the Longwall Method of Mining. *Human Relations*, 4(3), 13-38. doi: 10.1177/001872675100400101
- Weick, K. E., & Sutcliffe, K. H. (2001). *Managing the Unexpected: Assuring High Performance in an age of Complexity*. San Francisco: Jossey-Bass.
- Wolf, F. G. (2001). Operationalizing and Testing Normal Accident Theory in Petroleum Plants and Refineries. *Production and Operations Management*, 10(3), 292-305.
- Woods, D. D., & Branlat, M. (2011). *How Human Adaptive Systems Balance Fundamental Trade-offs: Implications for Polycentric Governance Architectures*. Paper presented at the Fourth Resilience Engineering Symposium, Sophia-Antipolis, France.
- Xiao, Y., & Moss, J. (2001). *Practices of High Reliability Teams: Observations in Trauma Resuscitation*. Paper presented at the the Human Factors and Ergonomics Society 45th Annual Meeting.
- Zolfagharian, S., Ressang, A., Irizarry, J., Nourbaksh, M., & Zin, R. M. (2011). *Risk Assessment of Common Construction Hazards Among Different Countries*. Paper presented at the Sixth International Conference on Construction in the 21st Centurey (CITC-VI), Kuala Lumpur, Malaysia.
- Zwetsloot, G. I. J. M., Aaltonen, M., Wybo, J.-L., Saari, J., Kines, P., & Beeck, R. O. D. (2013). The Case for research Into the Zero Accident Vision. *Safety Science*, 58, 41-48. doi: 10.1016/j.ssci.2013.01.026

EXPLORING PREFABRICATION FACILITY SAFETY IN THE U.S. CONSTRUCTION INDUSTRY

Sebastian Soto¹⁰, Bryan Hubbard¹¹ and Sarah Hubbard¹²

1 Sebastian Soto, Purdue University, 401 North Grant Street, West Lafayette, IN USA, 47907

2 Bryan Hubbard, Purdue University, 401 North Grant Street, West Lafayette, IN USA, 47907

3 Sarah Hubbard, Purdue University, 1401 Aviation Drive, West Lafayette, IN USA, 47907

The prefabrication and modularization of building components has been used in the construction industry for decades. It has recently made worldwide resurgence, with broader applications than ever before as the component size has become larger and more complex. The claimed benefits of prefabrication include increased productivity, quality and safety. As construction companies increase their development and implementation of prefabrication capabilities, many are setting up manufacturing type work space near the construction site to minimize shipping costs and utilize construction labor from the site. As the prefabrication and modularization become increasingly complex, these off-site installations are becoming more like temporary factories with improvised production lines for assembly. The resulting prefabrication set-up allows some of the construction work to be performed under cover, protected from the weather and elements; it allows work to be performed at lower heights; it reduces jobsite congestion; and it facilitates quality control through the implementation of standard procedures for repetitious activities and at the same time allows an opportunity to reduce fatigue and injuries associated with these repetitive activities. All of these factors may contribute to improved safety. However, since construction companies do not have experience planning and developing factory lines, many may not be aware of or implement important factory safety concepts. There are many resources for factory health and safety information that include both regulations and industry specific resources. This research documents previous work in construction prefabrication and provides preliminary data from a pilot survey regarding constructor awareness of manufacturing principles including how safety and health are managed in a temporary manufacturing environment. The results illustrate the potential to increase safety by utilizing best practices from the manufacturing industry for application in off-site prefabrication facilities for construction.

Keywords: construction safety, prefabrication, modularization.

¹⁰ ssotoort@purdue.edu

¹¹ bhubbard@purdue.edu

¹² sarahh@purdue.edu

INTRODUCTION

Traditional construction work is conducted on-site, and reflects a variety of challenges, including a large number of people and activities associated with numerous subcontractors, an ever changing workplace as the construction project progresses, and harsh working conditions due to weather and the close proximity of heavy equipment and other hazards. More recently, some construction projects have utilized off-site locations to build modules and pre-fabricated components. As these off-site locations become more common and as the construction at these locations becomes more complex, it is worth examining whether the safety practices on these sites are appropriately governed by traditional construction safety protocol, or whether other safety protocol such as the safety practices in manufacturing should be considered for implementation.

BACKGROUND

Prefabrication involves the fabrication or assembly of components off-site which are then transported to the construction site for installation at the appropriate time (Shahzad & Mbachu, 2012). In 2009, prefabrication was considered one of the “Activities with Potential for Breakthrough” in construction by the U.S. Board on Infrastructure and the Built Environment Division on Engineering and Physical Sciences National Research Council (Committee on Advancing the Competitiveness and Productivity of the U.S. Construction Industry (CACPUIC), 2009)

In 2011, a study on prefabrication in the U.S. construction industry indicated that 100% of all the surveyed professionals had a fairly low usage of prefabrication (Bernstein, 2011). Only about a third (37%) had been using it at a high or very high level (on more than 50% of projects). However, the use of prefabrication is expected to grow, and soon almost half of construction companies will be using prefabrication at a high or very high level as almost all of the surveyed professionals (98%) expected to be doing some prefabrication on their projects by 2013. The kind of construction task also affects the applicability and utilization of prefabrication. Contractors such as fabricators, mechanical contractors and design-builders tend to have more projects that utilize prefabrication (Bernstein, 2011). Recent research confirms the increasing importance of prefabrication, and experts continue to predict an increase in the use of modularization and prefabrication in the U.S. construction industry (Bowman et al., 2013).

The continued growth of prefabrication is due to the many advantages associated with prefabricated projects. Advantages are primarily associated with the transition from the construction site to factory conditions where the environment is more controlled, and where it is easier to improve safety, productivity and quality (Gibb, 2001). Other benefits with off-site prefabrication include less waste and fewer environmental impacts (Ferguson, 2012), as well as reduced construction time, reduced construction labor costs and reduced need for the mobilization of skilled labor (CII, 1992).

There is a clear trend towards increasing prefabrication in the construction industry. Prefabrication is considered a key component for the improvement of productivity, quality, safety, scheduling, and cost control in the construction industry, and prefabrication will provide an opportunity for the construction industry to become more efficient in the next 20 years according to numerous industry experts (CACPUIC, 2009) and Bowman et al., 2013).

One significant benefit of prefabrication is the positive impact on the project scheduling. With the use of prefabrication, contractors can significantly reduce the total time required to complete their projects by engaging a number of activities simultaneously (Blismass, Pasquire & Gibb, 2007), by reducing vulnerability to adverse weather conditions, and by reducing the amount of time required for field erection due to the increasing size and sophistication of the modular components that are construction off-site. The benefits have been realized worldwide. In a survey done in Hong Kong for high rise buildings, Jaillon & Poon (2008) documented that the construction time per floor was considerably reduced (by four to six days per floor) using prefabrication. The finding that prefabrication reduced overall construction schedule was confirmed by Bernstein's (2011) survey, which documented that almost 35% of the respondents using prefabrication have reduced the project schedule by four or more weeks.

Increased quality was another benefit of prefabrication in the construction industry. Prefabrication improves the quality and consistency of construction components. The improvement in quality is attributable to the controlled environment in which prefabricated components are assembled, and gains are realized not only due to higher quality, but also due to the reduced number of reworks. The quality gains increase as the environment approaches industrial manufacturing conditions (Gibb & Isack, 2003). Prefabrication may also support sustainable construction by reducing construction waste due to the more tightly controlled construction process. One study documented that prefabricated construction produced 70% of the waste generated by traditional construction methods. Moreover, some tasks have even more dramatic reductions -- concrete, reinforcement and plaster waste may be reduced by more than 90% in off-site prefabrication as compared to on-site construction (Tam, Tam, Zeng, & Ng, 2007). There are also more recent studies that indicate the construction industry is improving in waste management on the construction site (Clatas, 2011).

Improved safety performance is also a benefit of prefabrication. As prefabrication has increased in the last few years, so have the safety conditions in which the projects have been constructed. Over one third of companies using prefabrication indicated safety improvements as a result. Increased safety is associated with a reduced need for workers on scaffolding or ladders (Deemar, 1996), and reduced incidence of close work in tight spaces (Bernstein, 2011). In fact, safety benefits were some of the first documented benefits of prefabrication. Deemar (1996) and Gibb (2001) reported that prefabrication reduces the number of on-site personnel, reducing congestion on the jobsite and increasing safety. Many kinds of health hazards are reduced through prefabrication because the environment of the prefabrication facility is much more controlled (Deemar, 1996). As more prefabrication is implemented in the construction industry and construction site safety is improved, the gap between safety incidents rates in manufacturing and construction would be expected to decrease. In some places, this has been realized, as evidence by a recent study in the U.K. by Krug and Miles (Krug and Miles, 2013) which shows no significant differences between the accident rate for manufacturing and construction.

However, it is important to note limitations to safety gains through off-site prefabrication. Bernstein's study indicated that 10% of respondents indicated safety concerns on-site due to prefabrication. The installation of very large, prefabricated components presents unique safety concerns, and the installation of these large, complex, prefabricated components needs to be carefully orchestrated to avoid a

negative impact on overall on-site safety (Bernstein, 2011). In another extensive study, McKay (McKay et al., 2005) examined the benefits of an offsite construction environment and focused on many of the safety benefits. The paper noted that offsite production facilities could benefit from safety practices used in the manufacturing environment.

METHODOLOGY

Given the increasing use of prefabrication, this research sought to better understand the current practices of contractors in the industry regarding off-site prefabrication. In order to gain a better understanding of current practices, construction companies were surveyed regarding their activities. The results of this pilot survey are presented in this paper, as are suggestions for additional research.

SURVEY ON PREFABRICATION

The survey questionnaire focused on a number of issues related to prefabrication and construction safety, including the decision making process as to whether the firm should self-perform or outsource (subcontract) prefabrication activities, current trends regarding prefabrication, and the opinions and experiences of contractors and subcontractors with prefabrication experience.

The online survey consisted of 19 questions. The first section focused on demographics of the respondent and the specialty area of the firm. The next section focused on prefabrication, and included questions regarding the respondent's personal experience and the firm's experience. The survey included a wide variety of questions, including multiple choice questions, open questions which allowed elaboration regarding key topics, Likert scale questions in which the respondent was asked to agree or disagree on a scale from 1 to 5, and questions in which the respondent was asked to rank alternatives. Surveys were targeted to firms that were expected to have some exposure to prefabrication, including large, small and mid-size firms.

Survey Results

There were 27 responses to the survey; some respondents did not answer every question. 42% of respondents who answered this question indicated that had more than 20 years of professional experience; 29% had between 16 and 20 years; 17% between 11 and 15 years; 0% between 5 and 10 years; and 13% indicated they had less than 5 years of professional experience in construction.

The primary functions of the firms participating in the survey are General Contractors (52%); 17% of the respondents are subcontractors; Project management consultant and Design and Engineering had both the same number of responses (4% each); five respondents (22%) worked in a company with a different function than the ones mentioned in the survey question, among these were: Education, consulting, operator and a combination of other answers.

As shown in Figure 1, most of the respondents worked in the industrial construction sector. The complexity of industrial construction makes it particularly well-suited to prefabricated components. Respondents could select more than one answer if they worked in multiple sectors.

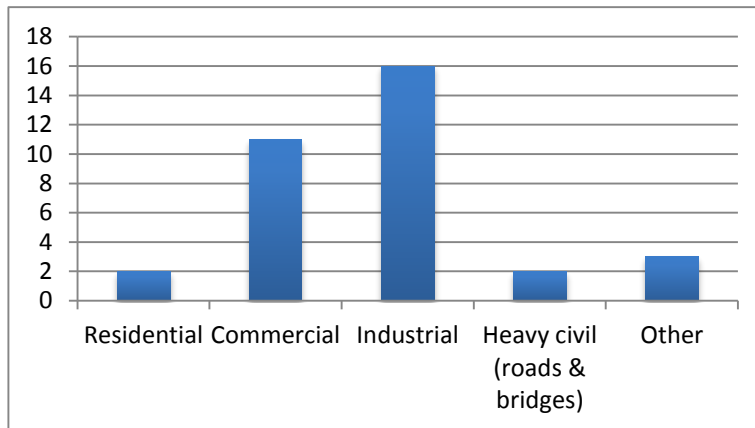

Figure 1: Construction sector (n=24)

Experience in prefabrication plants

Respondents were asked if their companies had ever set-up a temporary facility to build prefabricated components. Out of 24 respondents of this question, approximately half of the survey firms (46%) indicated to have had experience on setting up prefabrication facilities.

Safety

Respondents that had experience with prefab construction were asked additional questions about safety procedures in their prefabrication facilities. Results indicate that most firms use the same safety practices for off-site prefabrication as they use for on-site construction. Out of 11 respondents who indicated to have had experience on setting up prefabrication facilities, 73% indicated to have handled safety procedures equally between temporary facilities and construction sites while only 27% handled it differently. In addition to this, out of the 11 respondents, 45% indicated that they consulted and/or had experience in manufacturing safety principles while the remaining 55% did not consult or had any experience in manufacturing principles.

MANUFACTURING SAFETY ISSUES

These preliminary survey results indicate that a majority of constructors treat off-site prefabrication facilities for construction components as similar to a construction site when considering safety. This is not surprising, given the primary focus of the firms and the fact that the components are being prefabricated for the construction site. However, it is worth noting that there may be opportunities for off-site prefabrication facilities to benefit from the safety practices commonly implemented in a manufacturing environment.

In the U.S., the Occupational Safety and Health Administration (OSHA) oversee safety for workers. The standards that are focused on the construction industry are contained in OSHA Standards 1926 (OSHA, 2014a). The most frequently cited violations documented during OSHA inspections of construction sites are shown in Table 1. These violations reflect variance from the standards. All of the cited standards were from OSHA 1926 except for "Hazard Communications" which is from the general industry standards.

The standards for the manufacturing industry are mainly contained in OSHA Standards 1910 (OSHA, 2014a) for the general industry. OSHA's general industry standards also may apply to any industry to the extent that they supplement specific

standards for an industry. Common manufacturing OSHA regulations in contained in standard 1910 include: 1) Subpart O which deals with Machinery and Machine Guarding 2) Subpart I which deals specifically with PPE 3) Subpart J deals with general environmental controls 4) Subpart S which deals specifically with electrical equipment and electrical hazards. (Manufacturing-Safety, 2014)

The most frequently cited violations documented during OSHA inspections of the general industry are shown in Table 2. These violations reflect variance from the OSHA 1910 standards. Although contained in different standards, many of the manufacturing industry violations reflect hazards that are also present on the construction site, such as respiratory protection and lockout/tagout procedures. While the hazards may be analogous, the context is different in the construction and manufacturing environment. Awareness and understanding of the manufacturing safety principles outlined in OSHA Standards 1910 may allow constructors to increase the level of safety and reduce hazards at their off-site prefabrication facilities.

Table 1: Comparison of the most frequently cited OSHA Violations in Construction (NAICS Code: 23) versus the most frequently cited OSHA Violations in Manufacturing (NAICS Code: 31-33), (OSHA,2014b)

Rank	Violations in Construction	Violations in General Industry
1	Duty to have fall protection.	General requirements of all machines.
2	General requirements.	The control of hazardous energy (lockout/tagout)
3	Ladders.	Process safety management of highly hazardous chemicals.
4	Training requirements.	Wiring methods, components, and equipment general use.
5	Hazard Communication.	Powered industrial trucks.
6	Eye and face protection.	General requirements.
7	Head protection.	Mechanical power-transmission apparatus.
8	Aerial lifts.	Respiratory Protection.
9	Specific Excavation Requirements.	Hazard Communication.
10	General safety and health provisions.	Abrasive wheel machinery.

The opportunities for constructors to increase safety for off-site prefabrication may be illustrated through an example such as work station design. Work stations are evident in both off-site prefabrication and in manufacturing. While there has been little research regarding work station design in off-site prefabrication facilities, there has been extensive research regarding work station design in manufacturing, and constructors can benefit from this research. Work station design is important to reduce health hazards in manufacturing since the worker is often stationary at a piece of equipment for their entire work shift. The manufacturing task may be repetitive with little variation in movement, which can contribute to the development of musculoskeletal problems and other disorders (Salvendy, 2006 and COOHS, 2014). There are numerous ergonomic issues associated with tasks in the construction industry on the construction site, however, there are few workers that are standing or

sitting in one location throughout the day on the construction site. Construction companies setting up an assembly line process for prefabrication may be unaware of the current best practices and safety issues associated with this kind of repetitive work and there may be significant safety and production gains that can be realized by utilizing the best practices and lessons learned in manufacturing.

CONCLUSIONS

Prefabrication of components in the construction industry is on the rise and is a way for construction companies to increase productivity, quality and safety. Based on a recent survey, construction companies are using their knowledge of construction safety for prefabrication off-site. While construction companies' knowledge of safety in the construction work environment is extensive, there may be opportunities to leverage the research and safety best practices from the manufacturing industry for off-site prefabrication. Further research is suggested to identify relevant practices from manufacturing and develop best practices for off-site prefabrication in the construction industry.

REFERENCES

- Bernstein, H. M. (2011). Prefabrication and Modularization: Increasing Productivity in the Construction Industry. (E. Fitch, Ed.) (p. 56). Bedford, MA: McGraw-hill Construction.
- Blismass, N., Pasquire, C., & Gibb, A. (2007). Benefit evaluation for off-site production in construction. *Construction Management and Economics*, 24(2), 121-130.
- Bowman, J., Clancy, M., Giggard, R., Hoover, S., Hughes, J., Isaacs, S., ... Warner, P. (2013). *Construction Overview* (p. 75). Raleigh, North Carolina. Retrieved from [http://www.abc.org/Portals/1/Documents/CheifEconomist/FMI 2013 Forecast.pdf](http://www.abc.org/Portals/1/Documents/CheifEconomist/FMI%2013%20Forecast.pdf)
- Canadian Centre for Occupational Health and Safety (CCOHS) (2014). Working in a Standing Position. [ONLINE] Available at: http://www.ccohs.ca/oshanswers/ergonomics/standing/standing_basic.html .
- Committee on Advancing the Competitiveness and Productivity of the U.S. Construction Industry. (2009). *Advancing the Competitiveness and Efficiency of the U.S. Construction Industry* (p. 122). Washington DC.
- Construction Industry Institute (CII). (1992). *Automated Decision Support for Modular Construction* (p. 30). Austin.
- Construction Industry Institute (2002). *Prefabrication, preassembly, modularization and offsite fabrication in industrial construction: A framework for decision-making*. (CCO Publication): Austin, Texas, U.S.
- Deemer, G. R. (1996). Modularization reduces cost and unexpected delays. *Hydrocarbon Processing*, 10(75), 143-151
- Ferguson, H. (2012). Offsite Construction. *INGENIA*, (51), 46-49.
- Gibb, A. G. F. (2001). Standardization and pre-assembly- distinguishing myth from reality using case study research. *Construction Management and Economics*, 19(3), 307-315. doi:10.1080/01446190010020435
- Gibb, A., & Isack, F. (2003). Re-engineering through pre-assembly: Client expectation and drivers. *Building Research & Information*, 31(2), 146-160.

- Jaillon L., & Poon C.S. (2008). The evolution of prefabrication residential building system in Hong Kong: A review of the public sector and private sector. *Automation in Construction*, 18, 239-248.
- Kennedy, T. (2009). *Advancing the Competitiveness and Efficiency of the U.S. Construction Industry*.
- Krug, D. and Miles, J. (2013). *Offsite Construction: Sustainability Characteristics*. [ONLINE] Available at: http://www.buildoffsite.com/pdf/publications/BoS_offsiteconstruction_130709.pdf
- Lennartsson, M., Bjornfot, A. & Stehn, L. (2008). "Lean modular design: Value based progress in industrialized housing". *Proceeding of the 16th Annual Conference of the International Group of Lean Construction*, Manchester, UK.
- Manufacturing-Safety (2014). *A Resource for Manufacturing and Machining Safety*. [ONLINE] Available at: http://www.manufacturing-safety.com/OSHA_Regulations.html .
- OSHA (2014a). *Regulations (Standards - 29 CFR)*. [ONLINE] Available at: https://www.osha.gov/pls/oshaweb/owasrch.search_form?p_doc_type=STANDARDS&p_toc_level=0.
- OSHA (2014b). *Frequently Cited OSHA Standards*. [ONLINE] Available at: http://www.ccohs.ca/oshanswers/ergonomics/standing/standing_basic.html .
- Salvendy, Gavriel (2006). *Handbook of Human Factors and Ergonomics*. 3rd ed. : John Wiley & Sons, Inc.
- Shahzad, W. M., & Mbachu, J. (2012). *Productivity Enhancement of Construction Industry using Prefabrication Impact Levels of the Underlying Constrains and Improvement Measures* (p. 137). Auckland: LAP LAMBERT Academic Publishing.
- Tam, V. W., Tam, C. M., Zeng, S. X., & Ng, W. C. (2007). Towards adoption of prefabrication in construction. *Building and Environment*, 42(10), 3642-3654.

IMPROVING HEALTH AND SAFETY THROUGH INTERVENTIONS IN SAFETY CULTURES

Christian Koch¹³

¹ *Chalmers University of Technology, Gothenburg*

Changing safety cultures are regarded either as an accepted routine, a controversial effort or even an impossible approach by the different positions of scholars of safety culture. It thus remains disputed whether it is possible to purposely change safety cultures. The paper aims at critically evaluating two interventions designed to change safety cultures in the Danish Building industry targeting improvement of the health and safety. Using a symbolic interactionism analysis of safety cultures as a common point of departure, the designed intervention methods encompass elements such as using work place assessment and commonly developed guidelines to change the shared meaning of risk, of accidents and possible prevention. The methods employed to map the safety culture encompass ethnography, interviews, and documents analysis, and for the intervention action research. Strength and weaknesses of the applied methods is discussed including the multiple roles of the researchers. The paper describes and analyses first one designed intervention method used at three enterprises whereof excerpts from two are presented, and then discuss the experiences and effects juxtaposing the first evaluated method with another with a similar design. The initial analysis of the safety cultures in the selected case shows a configuration of multiple safety cultures differing over issues such as risk perception, and the stakes of prevention. The cultures stretch across sites, crews, contractors headquarter and the educational institutions. The effects of the interventions are evaluated, and the paper also raises issue with the limitations of measurability of safety culture change and improvement.

Keywords: Safety culture, change, carpenters, Denmark.

INTRODUCTION

An organizational culture, and a safety culture is deeply rooted, and a long term stable phenomenon (Geertz 1993, Richter and Koch 2004). Safety cultures, viewed through the symbolic interactionist lens adopted here, are understood as shared meaning and are viewed as a set of symbols, metaphors, myths and rituals (Alvesson 2003, Martin 2002). This understanding implies a stark opposition to corporate culture approaches, originating from Peter and Waterman (1982), believing that culture is something readily installed and manipulated by management (Alvesson and Svenningsson 2008). Nevertheless this paper claims that symbolic interactionism carries an implicit understanding of cultural change, viewing it as processes of social construction of shared meaning (Gherardi and Nicolini 2002). Changing the safety culture is therefore possible, even if strongly decoupled from intended actions. Planning and executing such culture change is the interest of the paper.

¹³ kochch@chalmers.se

The paper therefore aims at critically evaluating two interventions designed to change the safety cultures in the Danish Building industry aimed at improving the health and safety.

The main case comes from Richter and Pedersen (2004). Here the first step was to map and analyse the safety cultures at three carpenter's craftsman companies and then second on this basis to carry out a set of processes to change the safety cultures in order to improve the health and safety. The two elements, the safety culture analysis and the change work is separated in time but the researchers as well as some of the employees and other players were thoroughgoing.

The paper is beginning with a theoretical framework and method. Then follows one case of safety culture change work from Richter and Pedersen (2004). This case description consists of a presentation of the found safety cultures and then excerpts from the change process at two of the three enterprises that participated. In the final analysis this case is then compared with another case of safety culture change also built on symbolic interactionism, but with a different approach (Dyhrberg 2004).

FRAMEWORK: ORGANIZATIONAL CULTURE AND SAFETY CULTURE

This section presents a brief introduction to the framework of understanding safety culture and the basis for carrying out change work. The framework of understanding builds on a literature review of organizational culture, safety culture and safety climate contributions. The review informed the ethnographic studies presented and discussed in this paper. The notion of "organizational culture" is usually used to denote the shift away from national cultures and corporate cultures toward a more micro-oriented view of organizations. This trend has been dominated by two main paradigms: functionalism (Schein 1992 a. o.) and interpretivism (including symbolism, Alvesson 2003, Geertz 1993, Martin 2002). The symbolic interactionist approach perceives organizations as constructed by people and reproduced by shared actions, symbols and ceremonies (Geertz 1993). Focus is on symbols, which are expressed verbally, physically, and through actions. Safety culture is viewed as a focused aspect of the organizational culture (Richter and Koch 2004). Safety culture can be defined as shared and learned meanings, experiences and interpretations of work and safety – expressed partially symbolically – which guide people's actions in relation to risks, accidents and prevention (Richter and Koch 2004). Safety culture is shaped by people in the structures and social relations within and outside the organization. Meyerson and Martin's (1987) suggestion of a three-perspective analysis, differentiation, integration and ambiguity/fragmentation, is followed here, with the extension of the concept of multiple configuration (Alvesson 2003). This approach appreciates quite complex cultural patterns.

Integration, differentiation and ambiguity

In Alvesson (2003)'s approach the three perspectives integration, differentiation and ambiguity is used to arrive at a possible multiple configuration of cultures, depending of the empirical setting.

The integration perspective underlines culture as an organization's shared understandings. Cultural manifestations are consistent and cultures would coincide with organizational units encompassing little internal variation (Schein 1992). Culture is an integrative mechanism, the social glue that holds a unit's members together (Schein 1992, Alvesson 2003). In Schein's version, common basic assumptions are the consistently shared element. Guldenmund (2010) suggests a similar integrative conceptualisation of safety culture as shared basic assumptions about safety. For example the shared basic assumptions includes what "being safe" means and what it does not and they are assumed to permeate the whole organization (Guldenmund 2010) or at least entire organizational units (Hale 2004). The integrative perspective on culture is adopted by many scholars of safety climate and safety culture (Glendon 2008, Guldenmund 2010).

The differentiation perspective focuses on diverging interpretations, experiences and assignments of meaning in organizations. Contributors to this perspective have different analyses of which units of differentiation characterise a field be it countries, enterprises, between plants in multinationals, hierarchical levels within an organization, in departments, professions or groups, but such cultures co-exist in the organization, they do not come together in one overarching culture as the integration perspective assumes. For example Alvesson (2003) focus on the everyday work practices that produce local cultures, thus cutting across social structures and advocating a more cautious approach to interpreting differentiation in cultural manifestations; arguing for an analysis that discriminates between social structural and cultural differences.

The ambiguity perspective acknowledges uncontrollable uncertainties in the manner people would assign meaning to cultural manifestations (Martin 2002). Cultural manifestation might involve differences in meanings, interpretations of symbols etc., which are incommensurable and irreconcilable (Alvesson 2003). This even might manifest itself as cultural fragmentation (Martin 2002). Moreover, the continual process of creating and recreating meaning, may encompass members of different cultures orienting themselves differently at different times (Alvesson 2003). Again Alvesson (2003) points out that ambiguity might originate from social structures or social practises. Gherardi and Nicolini (2002) in their study of safety cultures at a building site thus finds ambiguity and differentiation with regard to professional background and work tasks in its analysis of meanings attributed to accident causes and preventive issues among employees, engineers and site managers.

Multiple configuration

The concept of "multiple configuration" combines the approaches (Alvesson 2003). Organizations can be understood as shaping local versions of societal and local cultural manifestations in a multitude of ways. People are connected to a variable degree with an organization, sub-organizational unit, profession, gender, class, ethnic group, nation etc. This explains cultural overlap without tight connection to the social structures of the organization. The approach appreciates the role of grander cultures, local cultures and at-a-time possible integration and unity, fragmentation or ambiguity in an mixing and overlapping fashion. Duc (2002) for example finds that site managers give ambiguous prescriptions. Furthermore, processes of identifying risks or reporting errors can be undermined, if the possibility of differentiated understandings is not recognized, even if the presence in an organization is an empirical question.

These meaning giving processes are socially negotiated, which leads to the possibility of changing the cultures.

Changing safety cultures

It can almost be described as central “identity work” for the symbolic interactionist approach to organisational culture to claim that culture cannot be managed or changed in a directed manner (Martin 2002). Parts of the cultural trait are its tacit and its bodily element. Nevertheless symbolic interactionism scholars share the position that culture is a social construct. It is contended that culture is produced through social interaction (Alvesson 2003, Geertz 1993, Martin 2002). And the discourse is full of examples of mechanisms that produce culture, be it the role of the founder of a small enterprise (Alvesson 2003), or the so-called “cultural traffic” pointing at how culture change when members travel in and out of organizations (Alvesson 2003). Other contributors combine the social construction with practice based learning (Gherardi and Nicolini 2002), a type of learning including tacit, non-verbal interaction. Moreover Alvesson (2003) emphasises how social structure interact with cultures thus indirectly pointing at a way to change culture is to change social structure, even if not in a one to one manner. Finally in a multiple configuration of safety cultures, changing the cultures also meaning shifting emphasis and power between present cultures, also including drawing on national safety cultures (Koch 2013). Antonsen (2009) is carrying out an extensive discussion of the possibilities of safety culture change, and mainly conclude that this is not possible in a direct manner, but that there is a need to understand culture to design interventions (Antonsen 2009:141). In his progress towards this conclusion he analyse first an example of change of procedures and second advocates use of action research, and third give advice for culture change work. Alvesson and Svenningsson (2008) investigate an organisational culture project that fails meaning it creates unanticipated and unintended consequences by reproducing certain meanings and ideas in the company followed. Alvesson and Svenningsson (2008) point a number of explanation why the cultural change failed; Problems of coordination, other priorities taking precedence, an emotionally unconvincing project as it exhibited a high degree of instrumentalism in its step by step approach, a poor symbolic performance, a moderate and fluctuating degree of engagement from senior managers and implementers and thereby a lack of symbolic expressiveness, concluding that the project suffered from symbolic anorexia (Alvesson and Svenningsson 2008: 106).

Summarising; the symbolic interactionist approach to safety culture adopted here appreciates a possible multiple constellation of safety cultures, of shared meaning of risk and prevention, differentiated between systems of meaning and possibly involving ambiguity. A multiple constellation provides a healthy variety of opinions in the organisation and it is contended that change of these safety cultures only can be carried out in participative and broadly involving manner where main culture producers are directly mobilised to design change. But even under such circumstances the controllability of the culture change process is limited and can lead to unanticipated processes and effects.

METHOD

The two studies (Dyhrberg 2004, Richter and Pedersen 2004) discussed here stems from a cluster of safety culture projects with a common theoretical, methodological and analytical set up and covering ten different organisations in construction and manufacturing. These studies used the symbolic interactionist ethnographic approach,

which is characterized by an open set of concepts for the ethnographer's fieldwork (Geertz, 1993). As a frame for this, a review of safety culture studies was made using multiple sources, such as a literature study of organization culture and safety culture (Koch 2013, Richter and Koch 2004). The framework is briefly summarised below. In the empirical work, symbols were looked for and listened to through emic participation, be they verbal, physical or bodily (Martin 2002); the researcher was present on site for a period, making observations and engaging in dialogues, but not participating directly in the work. Verbal symbols include metaphors, myths and narratives, as well as meanings and interpretations regarding central aspects of on-site safety. Actions expressed in a ritual format were also followed – for example, at safety meetings. The researcher exercise empathy with the field, while also maintaining sufficient distance to it (Alvesson 2003). In this way, it was sought to capture and question elements of everyday understandings and practices.

Richter and Pedersen (2004) is the study in focus here as the most comprehensive study of construction in the cluster. Richter and Pedersen (2004) is two sided: First an ethnographic study encompassing three carpenter's contractors active in renovation and new build. Second a study of a school for carpenters and the cultures there. It was funded by the Health and Safety Executive (HSE), Denmark. The small and medium sizes enterprises were selected in collaboration with the Danish construction employers' association (Dansk Byggeri), which provided a list of eight companies. Three agreed to participate. They all employ predominantly skilled workers, as is common among Danish trade contractors. Employment fluctuated, but was respectively roughly 200, 100 and 20 employees. The study encompassed five building sites where 66 persons were employed, including nine apprentices. The carpenters' safety culture was studied through following work during a whole workday for between five and ten days over a longer period, supplemented by semi-structured interviews carried out with masters, quantity surveyors, foremen and other central persons. As a working definition it was decided that six persons need to refer to a set of meaning before it was recognised as a culture. The subsequent cultural change work was facilitated by the researcher by early inputs on the safety culture analysis and proposals for preventive measures. The process was carried out as action research (Greenwood and Levin 2007), yet featured the researchers in relatively influential roles. The researchers acted as ethnographer, expert and process facilitator, analysts and responsible for reporting. This was handled through separating the ethnography from the action research in two distinct phases.

As a means of comparison Dyhrberg (2004) is used. It is a long-term ethnographic study of a precast concrete element production unit. This involved a planned intervention aiming to change the safety culture, which was then evaluated. Even if the study is of a manufacturing plant for precast concrete, the method and change process carried out exhibit a number of similarities with the Richter and Pedersen (2004). The two studies were also carried out within the same research environment. Dyhrberg acted as ethnographer and reported the safety culture analysis and the change process. However the main responsible for the change process was external health and safety consultants. The results are reported in Dyhrberg (2004), her doctoral thesis, where the author of this paper was supervisor. It should be underlined that the two studies of safety cultures are carried out in unique contexts and exhibits unique processes. For example the Dyhrberg (2004) study involves a visit from the Health and Safety Executive which initiates the process.

CASE

The description below follows the process of safety culture change, giving two examples of the process which have been largely similar in the three participating companies. The description therefore first starts focusing on the large enterprise and second ending with the small. Richter and Pedersen (2004) encompassed two main elements: prevention activities at the school for carpenters and prevention activities at three companies with an overall focus on apprentices. Briefly the safety culture analysis at the school showed "split arenas for learning" showing that teachers and apprentices preferred to perceive the school area as detached from the company arenas. Here the focus is on the enterprises thus reducing the story slightly.

The change process started by a study of the safety culture, where a multiple configuration of cultures were found (Alvesson 2003, Koch 2013, Richter and Koch 2004). The study and analysis of the safety cultures of the enterprises are described elsewhere (Koch 2013), here the description focus more on the change process. The main cultures of the enterprises were, in a differentiation perspective (Koch 2013):

- Mastering
- Framework and rules
- Drawing board and plan
- Ties that bind

See table 1 for a further presentation of the multiple constellation and the integration and ambiguity perspective. The three companies featured different multiple configurations of the type show in table 1. The found cultures were presented in short communicative reports elaborated by the researchers targeting each of the three participating companies. In each company a project group were formed. The company reports were presented at a first meeting of this selected group. For this meeting the researchers also developed a set of proposals for possible prevention activities. These proposals for action were generated directly from the insights of the safety culture studies. Representatives of crews, masters, foremen, and health and safety committee representatives participated in the project group in all three enterprises. One researcher participated as side person and occasional consultant for the group. The following excerpt is from the largest enterprise:

At the first project group meeting one craftsman reacted in this manner to the enterprise report's description of safety cultures:

"it is a curious way to portray it. It is different from the way I otherwise think safety, but nevertheless, I can recognize it. Personally I feel I belong to all three safety cultures" (Richter and Pedersen 2004:49)

The group was very engaged in initiating "something". However when presented for concrete practical proposals for action, ambiguity grew amongst the participants. The dialogue emerged into a decision to start working in smaller groups with the proposals. The groups later decided to design a more involving version of the obligatory workplace assessment called "Active workplace assessment". They met six times one hour and finally presented their result to each other and the health and safety committee including site managers.

Table 3: The multiple constellation of safety cultures (Koch 2013)

Differentiation Perspective	Risk	Accidents	Prevention	Health and Safety activities
Mastering	can be handled by the competent crafts-man	due to human error	take care of yourself and others	of less importance: people manage on their own
Framework and rules	unacceptable, but reduced if conditions are ok	due to lack of action regarding inappropriate or illegal conditions	put your foot down, act and demand improvements	the formal system should be used; combine personal and common effort
Drawing board and plan	unacceptable and difficult to handle in pressed situations	due to incalculable conditions and distance between contractors and other players	via own planning, good design, cooperation and coordination on site	formal system should be used early and systematically: all contribute
Ties that bind	atypical-other conditions are more important	Casual or singular events	no special opinion: rules are unrealistic for practise	waste of time
Integration Perspective	Professional pride, autonomy and companionship at work			
Ambiguity Perspective	Examples of contradictory assignment of meaning of safety and of the safety representative			

Shifting to the smallest enterprise, the focus here was on creating safety in the building project and less the enterprise. Three proposals appreciating the informal style of health and safety activities were developed, but also came to appreciate that representatives from the enterprises felt an external pressure for professionalisation of the health and safety issue:

”we experience in 90% of the projects that we are asked to make a plan for health and safety!” (Richter and Pedersen 2004: 51)

The practical proposals encompassed check lists for the phases of a building project aimed at managers on site and a similar check list for the crew. In the design processes consensus was developed through balancing and neutralising contradictory concerns such as costs, regulatory demands and the safety of the employees, identifying a reasonable level recommendable to the company. For example on issues on the cost of scaffolding and lift equipment. The group convened eight times at two hour meetings through the construction project process. Then followed a meeting with the manager/master which approved the proposals and they were turned into permanent guidelines. The group was positively surprised by the thorough back up of the manager/master.

Across the three enterprises the evaluation of the participants of the process was positive. The participants articulated that it had been “fun, exciting and educational”. Many participants learned something according to their feedback. They described the

process as an "eye opener". Moreover it allowed first more participation from craftsman employees and second it also impacted on the companies' managers. One manager in the largest company thus moved from scepticism towards workplace assessment to requiring more material from other building sites on how they did work place assessment.

ANALYSIS

Below we first analyse the described case of safety culture change work and then juxtapose it with another developed by Dyhrberg (2004). In the described case (from Richter and Pedersen 2004) the change work at the three participating enterprises ended up looking a lot like "usual preventive H&S work" i. e. developing check lists and guidelines. The impact of these activities was nevertheless part of a culture change as new consensus on how to tackle a range of H&S issues were developed. In other words the safety culture change emerges through negotiations on practical safety measures that demands a consensus on for example what creates dangerous situations and how can they be prevented. This can largely be ascribed to the enlarged and changed set of actors that participated in the meetings, developing and using the checklists and guidelines. The kind of culture change carried out is therefore an indirect type as also discussed by Antonsen (2009). As pointed out in the framework above directed exterior actions on changing (safety) culture risk have limited effect (Alvesson and Svenningsson 2008).

In everyday work the various safety cultures are in latent conflict with each other and they imply different strategies of action. The dialogues on the change activities revealed these potential contradictions. And they opened up for both criticism and developing mutual respect. Moreover the safety culture issues became embedded in the guidelines.

However changing a safety culture cannot be expected to occur under relatively short processes as those carried out in Richter and Pedersen (2004). It is a longer and ongoing process and reverse developments might occur.

Dyhrberg (2004)'s analysis is in many aspects more comprehensive than Richter and Pedersen (2004) mainly due to the differences in resources and focus. Dyhrberg's study initially finds four safety cultures in a differentiation perspective. Dyhrberg (2004) develops four criteria for evaluating a possible change in the safety culture after the intervention carried out. First, time has to pass before evaluation of culture change is possible, second the question is raised whether the intervention did open space for cultural changes. Third a change in central features of shared meaning, the systems of meaning, has to occur. Fourth it should be evaluated whether there is changes in underlying social structures (re Alvesson 2003 distinction between culture and social structure). Dyhrberg finds a remarkable change in the constellation of cultures, were briefly a culture of fiery souls supporting the change emerged and a culture parallel to the above mentioned "mastering" faded out during the intervention, something Dyhrberg (2004:135) have several contradictory interpretations of; either the individual handling of risk approach did lose momentum, or the position became slightly tabooed during the intervention. Dyhrberg (2004:240) also include evaluation of the occurrence of (reported) accidents, incidents and changed procedures and conclude that there has not be a decay in accidents and that the intention of registration of grave incidents only led to one registration.

Where Richter and Pedersen (2004) embed their change work in three carpenters craftsmen and in the craftsman educational institution, then Dyhrberg (2004) embed it in the single enterprise with an alliance with the occupational health and safety services (which today operate like a consultancy company). Both approaches underline therefore that culture change goes beyond the single building site that have often been the object of the safety culture studies (Baarts 2004, Koch 2013). Koch (2013) take this consideration to its full scope arguing that national safety cultures might be in play on single building sites and national safety cultures can and should be changed through education, public regulation and more.

In carrying out the culture change work there is a danger of referring to and using the “usual suspects”. The safety representatives and safety committees are parts of the safety cultures and not external to them, they can therefore be part of the problem rather than the solution. Even if the safety committee is involved in the safety culture change the committee is not assigned a central role in the change work reported here.

CONCLUSIONS

This paper set out to critically evaluating two interventions designed to change the safety cultures in two parts of the Danish Building industry aimed at improving the health and safety. To do so the symbolic interactions framework for interpreting multiple constellations of cultures was summarised and a discussion of fit with cultural change was carried out, arguing that cultural change was possible within this perspective yet appreciating its uncontrollable features. Through the case of three carpenter contractors (whereof two was described shortly here) it was discussed how safety culture change work was carried out and what results it had given. The process involved a number of safety culture producers and led to improved attention and language of safety issues, yet the studied period made it impossible to make strong conclusions. The case was then compared to another case with a similar design were a displacement of the multiple constellation of safety cultures was found, appearing as an underpinning of prevention of accidents, even if reductions of accidents did not occur. It can be concluded that safety culture change can be carried out, but that it often within research projects time and resource frame will be difficult to measure the culture change that supporting activities prepare. For the industry the approach might appear more costly as a more elaborate culture analysis is carried out. It is contended however that a too limited knowledge base for safety culture change would risk leading to advert effects, if the differentiation between cultures is lost.

ACKNOWLEDGEMENTS

I would like to especially acknowledge the empirical and analytical work carried out by M. Dyhrberg, A. Richter, A. Kamp, H. Engberg and E. F. Pedersen.

REFERENCES

- Alvesson, M (2003) *Understanding Organizational Culture*. SAGE, London.
- Alvesson, M, and Sveningsson, S (2008) *Changing organizational culture: cultural change work in progress*. London. Routledge.
- Baarts C (2004) *Viden og kunnen - en antropologisk analyse af sikkerhed på en byggeplads*. Københavns Universitet. København (Knowledge and knowing- an anthropological analysis of safety on a building site).

- Duc, M (2002) *Le travail en chantier*. Octares, Paris. (Work on a building site).
- Dyhrberg, M B (2004) *Forebyggelse af arbejdsulykker – Et sikkerhedskulturperspektiv*. Institut for Produktion og Ledelse. Technical University of Denmark, Lyngby. (Prevention of occupational accidents – a safety culture perspective).
- Geertz, C. (1993) *The Interpretation of Cultures*. Fontana Press, London.
- Gherardi S and Nicolini D (2002) *Learning the Trade: A Culture of Safety in Practice*. "Organization" 9(2), 191-223.
- Glendon, I (2008) *Safety culture and safety climate: How far have we come and where could we be heading*. "Journal of Occupational Health and Safety. Australia and New Zealand" 24(3), 249-271.
- Greenwood, D and Levin, M (2007) *Introduction to Action Research*. Sage, Thousand Oaks.
- Guldenmund, F (2000) *The nature of safety culture: a review of theory and research*. "Safety Science" 34 (1-3), 215-257.
- Guldenmund, F. (2010) *Understanding and exploring safety culture*, Boxpress, Oisterwijk.
- Hale, A (2004) *Letter to the editor*. Safety Science 42(10), 979–983.
- Koch C (2013) *From Crew to Country -Local and National Construction Safety Cultures on Construction Sites*. "Construction Management and Economics". 31(6), 691-703.
- Martin, J (2002) *Organizational Culture: Mapping the Terrain*. Sage, London.
- Peters, T and Waterman, R, (1982) *In Search of Excellence*. Harper & Row, New York.
- Richter, A. (2001) *Nye ledelsesformer, sikkerhedskultur og forebyggelse af ulykker*. TUD, Lyngby. (New forms of management, safety culture and prevention of accidents).
- Richter, A and Koch, C (2004) *Differentiation, Integration and Ambiguity in Safety Cultures*. "Safety Science", 42(8), 703–22.
- Richter, A and Pedersen, E F (2004) *‘Arbejdsulykker! Alle har en historie’ Om sikkerhedskultur og læring i tømrerbranchen*, BYG.DTU, Lyngby (Occupational accidents! Everybody has a story, on safety cultur and learning in construction).
- Schein, E H (1992) *Organizational Culture and Leadership*, 2nd ed. Jossey Bass, San Francisco.

USING A WALKWAY WITH ADJUSTABLE INCLINATION TO MEASURE AND ASSESS SLIP AND FALL RISKS

Chuansi Gao¹, Amitava Halder¹, Ingrid Svensson², Gunvor Gard³, Giorgos Nikoleris⁴, Per-Erik Andersson⁴, Måns Magnusson⁵

¹ *Division of Ergonomics and Aerosol Technology, Department of Design Sciences, Faculty of Engineering, Lund University, Sweden*

² *Division of Biomedical Engineering, Department of Biomedical Engineering, Faculty of Engineering, Lund University, Sweden*

³ *Division of Physiotherapy, Department of Health Sciences, Faculty of Medicine, Lund University, Sweden*

⁴ *Division of Machine Design, Department of Design Sciences, Faculty of Engineering, Lund University, Sweden*

⁵ *Balance laboratory, Division of Otorhinolaryngology, Department of Clinical Sciences, Faculty of Medicine, Lund University, Sweden¹⁴*

Fall is the most common cause of serious work related accidents. Falls and related injuries not only cause suffering for individuals, but also means a high economic burden to industries and society. The objective of the study was to use a walkway with in-built force plate, adjustable inclination and surface to assess how risks of slips and falls vary due to inclination and friction of the walkway surface. A walkway was designed with adjustable slopes between 0 to 30 degrees. Subject walking tests were performed on dry and wet steel sheet surfaces in two walking directions (uphill and downhill) at three inclination angles (0, 5 and 10 degrees). 3D ground reaction forces while walking were recorded using the force plate. Required coefficient of friction (RCOF) was derived to determine slip and fall risks. The main finding of this study is that the RCOF during heel strike when walking downwards on the steel plate surface increases linearly as the inclination increases. The results contribute to the understanding of slipping and falling mechanisms and the prevention of slipping and falling accidents. When ramps or sloped surfaces are used in workplaces, slip resistance between footwear and the sloped surfaces should be improved.

Keywords: slips and falls, slope, gait biomechanics, required coefficient of friction.

INTRODUCTION

Fall is the most common cause of occupational accidents among women and the second most common among men. A total of 104,000 occupational injuries are reported for the year 2010 in Sweden (Arbetsmiljöverket 2011). Of the hospitalized due to falls, 48.9% are caused by slipping and tripping (Socialstyrelsen 2012). According to a report by AFA Insurance in Sweden, 37.7% of serious work accidents (18 372 cases) are due to either slipping, stumbling, stepping awry, lost balance or other reasons during 2010 and 2011 (AFA 2013). Building plate works (plåtslageri) in

¹⁴ Chuansi.Gao@design.lth.se

Sweden who manufacture roofing materials and mount such materials on roofs employs approximately 5 800 people. The number of workplace accidents in the sector were a total of 73 (12.8 per 1000 persons) in 2006. Fall incidents both on the same level and from heights (28%) are higher than the whole building sector (23%) (BCA 2007). The US Bureau of Labor Statistics show that floors, walkways or ground surfaces are the major sources of falls, causing over 86% of all fall-related injuries (Bureau of Labor Statistics 2004). Slipping or slipperiness is identified as the most common cause of falls on the same level, contributing to 40-50% of fall-related injuries (Andersson and Lagerlöf 1983, Courtney et al. 2001). This indicates that slips and falls are often interconnected.

Falls and related injuries not only cause suffering for individuals, but also economic burden to industries and society. The concrete, building and construction sector is the second occupational group with the highest frequency of falling outdoors among male workers (AFA 2013). Falls in postal delivery occurred in 30% of the cases when walking down a slope compared to 2% when walking up (Haslam and Bentley 1999). Falls from roofs are a serious cause of both fatal and non-fatal injuries in construction sectors. The majority of falls among those who work on roofs are due to loss of balance. The increased inclination, causing increased shear forces in combination with slipperiness of the surfaces could be important contributing factors for slipping, losing balance, and falling. The increased shear forces and required coefficient of friction (RCOF) should be able to be determined while walking at different inclinations in order to evaluate the risks of slipping and falling. Research is needed to specify a critical inclination, for walking/working surfaces, that will afford secure landing in the case of a fall (Hsiao and Simeonov 2001). Biomechanical studies of roofing tasks at different roof inclinations may help to determine the required slip resistance and define critical ranges of slopes for safe work on roofs.

Biomechanics of walking on a descending ramp covered with a plywood surface painted with slip resistance paint were studied by Redfern and DiPasquale (1997) and a corresponding study of a ramp covered with vinyl tiles was performed by Cham and Redfern (2002). The results showed that RCOF increased with the increase of the inclination. However, studies on steel plate as a walkway surface material while walking downwards on a ramp are scarce.

The objectives of the study were to use a walkway with an in-built force plate, adjustable inclination and steel plate surface to measure and assess slip and fall risks while walking down the walkway.

METHODS

Walkway with adjustable inclination and built-in force plate

A walkway was designed and constructed with adjustable inclinations (0-30 degrees) and a built-in force plate. The inclination angle could be adjusted using a hydraulic actuator. The walkway surface material was steel plate. The width of the walkway was 1.0 m and the length was 6.08 m (1.15m non-inclinable platform, 3.50m inclinable middle walkway with a built-in force plate, and 1.43m inclinable extension track) with the force plate placed at 3.35m from the beginning of the walkway and 2.73m from the end of the walkway. A force plate (600 x 400 mm, Kistler type 9281, Switzerland) was used to measure ground reaction forces when the test subjects walked on it (see Fig.1). The top of the force plate was covered with the same steel plate, and was flush

with and separated (about 2 mm) from the rest of the walkway surface. Three dimensional (3D) forces (horizontal anterior-posterior F_y , medial-lateral F_x and vertical F_z , see Fig.2) were recorded by a 64ch DAQ System (type 5695A) with BioWare® (2812A) (sampling frequency: 1000 Hz). The RCOF at the shoe-floor interface was defined as the shear force divided by the normal force when human subjects walked. Usually peak RCOF during heel strike (a sub gait phase when the heel gets in contact with the underfoot surface) is used to assess slip and fall risks (Redfern et al. 2001, Cham and Redfern 2002, Chang et al. 2012).

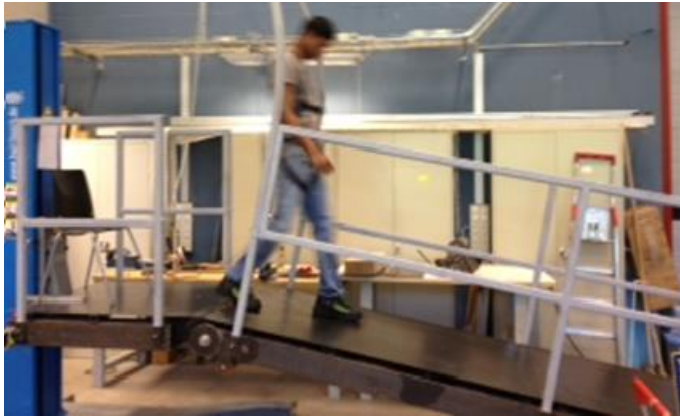

Fig.1 A subject walking on the ramp

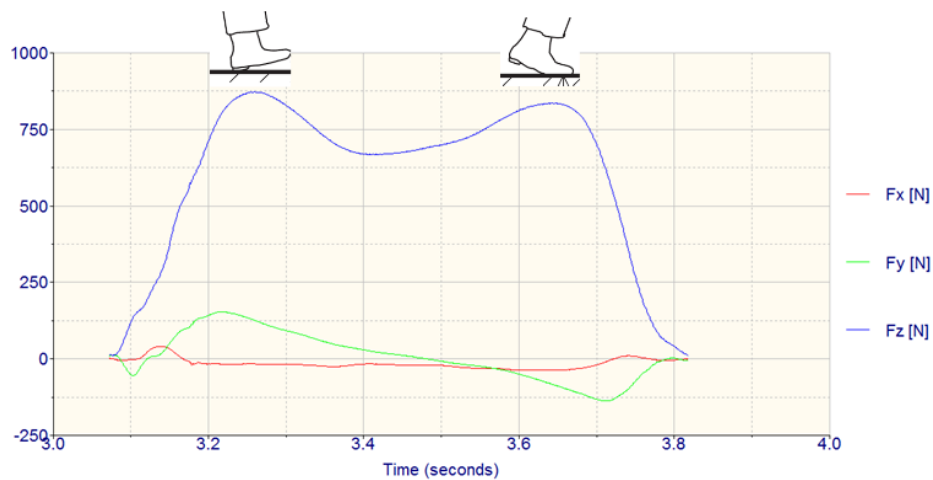

Fig.2 Three dimensional ground reaction forces (N) recorded during a stance phase including heel strike, mid-stance and toe off phases on the force plate

Three inclinations (0, 5 and 10 degrees) were tested in the study. The surface material of the walkway was steel plate, dry and spread with water. The results on dry steel plate surface are included in this paper. The same pair of work shoes with polyurethane (PU) outsole was used for all subjects and all walking trials.

Human subjects

Eight male subjects (mean age 28.8 ± 3.2 years, body mass 72.6 ± 10.6 kg, body height 1.75 ± 0.04 m) participated in the study. The subjects had no neurological, musculoskeletal, balance or other disorders and any medication that would affect their normal gait patterns. The study (project no. 100026) was approved by the regional

ethical review board in Lund, Sweden (EPN). The subjects signed informed consent prior to their participation in the study.

The subjects were instructed to walk at their natural and self-selected pace, and look straight front. The subjects practiced a number of times with safety harness before real measurements. The safety harness was provided to protect the subject from falling and getting injured in case of slipping events.

Experimental design

Two-way within subject design including 3 inclinations (0, 5 and 10 degrees), 2 surfaces (dry and wet steel plate), 2 walking directions (descending and ascending), totally 12 experimental conditions were applied in the study. Each subject performed 3 trials for each condition and this gives in total 36 walking trials for each subject. Totally 288 walking trials were recorded for the 8 subjects. Average peak RCOF values of the three walking trials during heel strike in the same condition were calculated. The results for 3 inclination angles, on dry steel plate surface during descending walking are included in this paper.

RESULTS AND DISCUSSION

The average values of the required coefficient of friction (RCOF) for three trials at each inclination angle and across eight subjects during heel strike while descending the walkway on dry steel plate surface are shown in Fig.3. The results indicate that the higher the inclination, the higher the RCOF. There is a linear relationship between RCOF and inclination angle as shown in the following equation and Fig.4.

$$Y = 0.0132 * X + 0.2379$$

Where, Y: RCOF; X: inclination angle in degrees

According to this equation, RCOF for different inclinations can be predicted, for example when an inclination angle equals 20 degrees, a slip resistance of 0.502 is required. These results are in agreement with those reported by Redfern and DiPasquale (1997) on dry plywood surface covered with slip resistance paint and by Chang et al. (2012) on level dry quarry tiles. The study by Redfern and DiPasquale (1997) showed that the peak RCOF ranged from 0.20 for level walking to 0.45 for a 20 degree inclination. This corresponds well to the predicted value from our findings (0.502 for steel plate) since the steel plate surface could be more slippery than a plywood surface coated with slip resistance paint, and therefore requires a little higher friction.

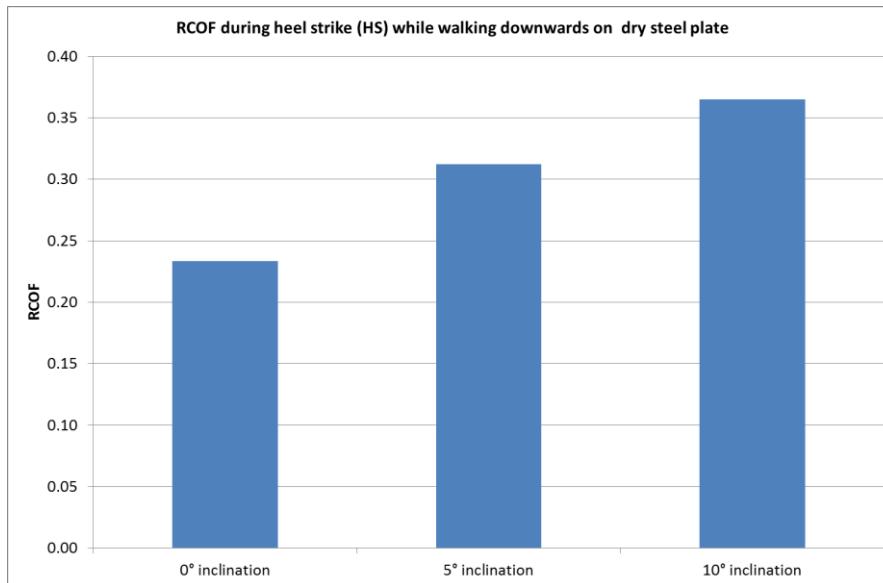

Fig.3 Required coefficient of friction while walking downwards on dry steel plate surface

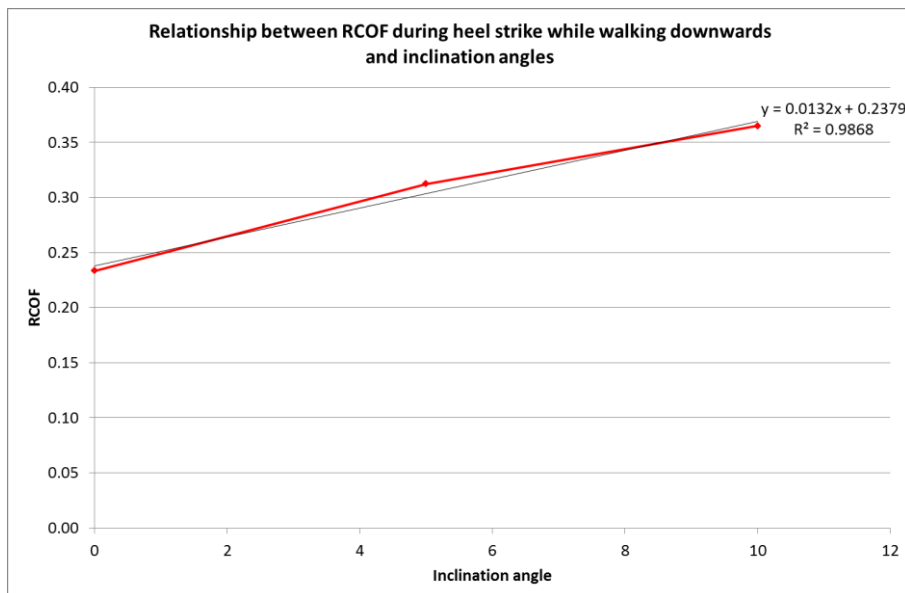

Fig.4 Relationship between RCOF during heel strike while walking downwards on dry steel plate and the inclination angles of the walkway

A human step can be sub-divided into heel strike, mid-stance, and toe off sub phases. The heel strike is the most critical phase in terms of slip and fall risks (Redfern et al. 2001, Grönqvist et al. 2001), particularly when descending a slope. The RCOF during heel strike is commonly used to represent the required slip resistance, thereby used to assess slip and fall risks, the higher the RCOF, the higher the slip and fall potentials (Cham and Redfern 2002). The results from the study on a plywood ramp covered with vinyl tiles showed a lower RCOF (0.18, 0.26 and 0.32 at inclination angle 0, 5 and 10 degrees respectively) while descending the ramp (Cham and Redfern 2002). These discrepancies might be caused by the different types of shoes and ramp surface materials. The length of the ramp used by Cham and Redfern (2002) was 1.8m long. During their study, the second or third step was recorded by the force plate. In the

present study, subject's fourth or fifth step was measured, which is believed to have captured the ground reaction forces during more stable and consistent gait.

The findings of this study imply that when ramps or sloped surfaces are used in workplaces, slip resistance between footwear and the sloped surfaces should be increased by improving the slip resistance of the footwear, the sloped surfaces or both. Commonly used footwear that is perceived safe on level surfaces may not provide the coefficient of friction required on sloped surfaces. Therefore, industries concerned should be aware of the increased slip and fall risks on sloped surfaces, inform individual workers and provide related safety and protective measures. The risks can also be reduced by avoiding the use of slopes if possible or by designing safer work platforms, walkways, roofs, etc. through reducing inclination.

CONCLUSIONS

The main finding of this study is that the required coefficient of friction (RCOF) during heel strike when walking downwards on the steel plate surface increases linearly as the inclination increases. The recorded RCOFs are 0.233, 0.312 and 0.365 at the inclination angle 0, 5 and 10 degrees respectively. The established linear relationship ($RCOF = 0.0132 * \text{inclination angle} + 0.2379$) can be used to predict slip and fall risks and required slip resistance. Further studies are needed to validate the equation, and to extend the range of inclination angles, the type of ramp surface materials, shoes and contaminations on the ramp surface, for example, oil, detergent, ice, etc.

ACKNOWLEDGMENT

This research is within the framework of the project "Slip and fall accidents, friction requirement and balance ability" (No. 100026) financed by AFA Insurance, Sweden. We wish to thank Dídac Trubat Ponti, Thomas Göransson, Hjalmar Hallberg, the members of the workshop and Kalev Kuklane for their contributions to the design and construction of the ramp, and the subjects for their participations in the study.

REFERENCES

- AFA Försäkring, (2013) Allvarliga arbetsskador och långvarig sjukfrånvaro (Serious injuries and prolonged absenteeism).
- Andersson, R and Lagerlöf, E (1983) Accident data in the new Swedish information system on occupational injuries. "Ergonomics", 26, 33 – 42.
- Arbetsmiljöverket, (2011) Arbetsskador 2010 (Occupational accidents and work-related diseases), Arbetsmiljöstatistik Rapport 2011:1. ISSN 1652-1110.
- Bureau of Labor Statistics, (2004) Fatal workplace injuries in 2004: a collection of data and analysis report. US Department of Labor. Washington, DC: BLS.
- Byggingustrins Centrala Arbetsmiljöråd (BCA), (2007) Arbetsskador i byggverksamhet (Occupational injuries in construction).
- Cham, R and Redfern, M (2002) Changes in gait when anticipating slippery floors. "Gait and Posture", 15, 159-171.
- Chang, W, Matz, S and Chang, C (2012) A comparison of required coefficient of friction for both feet in level walking. "Safety Science", 50, 240-243.

- Courtney, TK, Sorock GS, Manning DP, Collins JW and Holbein-Jenny MA (2001) Occupational slip, trip, and fall-related injuries – can the contribution of slipperiness be isolated? “Ergonomics”, 44, 1118-1137.
- Grönqvist, R, Chang, W, Courtney, T, Leamon, T, Redfern, M and Strandberg L (2001) Measurement of slipperiness: fundamental concepts and definitions. “Ergonomics”, 44, 1102-1117.
- Haslam, RA, Bentley, TA (1999) Follow-up investigations of slip, trip and fall accidents among postal delivery workers. “Safety Science”, 32, 33-47.
- Hsiao, H and Simeonov, P (2001) Preventing falls from roofs: a critical review. “Ergonomics”, 44, 537-561.
- Redfern, M and DiPasquale, J (1997) Biomechanics of descending ramps. “Gait and Posture”, 6, 119-125.
- Redfern, MS, Cham, R, Gielo-Perczak, K, Gronqvist, R, Hirvonen, M, Lanshammar H, Marpet, M, Pai CYC, and Powers C (2001) Biomechanics of slips. “Ergonomics”, 44 (13): 1138-1166.
- Socialstyrelsen (2012) Skador och förgiftningar behandlade i slutenvård 2011. Sveriges officiella statistik – hälso- och sjukvård (Injuries and poisonings treated in inpatient care 2011. Official statistics of Sweden - health care). ISBN 978-91-87169-87-8.

CSR, Regulations and enforcement

CHANGING CONSTRUCTION SAFETY CULTURE AND IMPROVING SAFETY OUTCOMES BY DESIGN THINKING AND CO-PRODUCTION: RESEARCH PROPOSAL AND PRELIMINARY RESULTS

Patrick X.W. Zou¹⁵, David Marsh¹, Mark Evans¹, Alex Sherrard¹ and Jerry Howard²

¹ *Institute for Governance and Policy Analysis, University of Canberra, Bruce, ACT 2617, Australia*

² *Master Builders Association of the ACT, 1 Iron Knob St., Fyshwick, ACT 2609, Australia*

This paper argues that in order to change construction safety culture and further improve construction safety performance, construction safety research needs to look beyond the traditional research methods and processes, which are generally supported by standard surveys and/or interviews for data collection. This paper presents a research proposal and preliminary results in which the principles of design thinking, in combination with knowledge co-production processes, are applied to the development of an integrated construction safety model. In such a co-production research process, the key stakeholders are engaged from the beginning of the research, and their knowledge and perspectives are constantly fed back to the research as it progresses. In doing so, the new knowledge and theoretical development generated from the research will be more relevant, practical and useful to the stakeholders and hence would have the “buy-in” from them, which will in turn help change the construction safety culture and improve safety outcomes. This paper introduces the concept of design thinking and knowledge co-production and discusses the approach, step by step, on how they can be applied in safety research. Following this the paper presents the preliminary results which were generated through a focused group workshop, as step 1 of this research proposal. The results include the identified key barriers for improving construction safety and topic areas for future research. The barriers identified include lack of a common definition or understanding or measurement of safety culture, lack of empowerment in the industry in relation to safety, lack of communication between policy makers and industry stakeholders and lack of a common safety picture or vision among stakeholders. To overcome these barriers, the topic areas for future research identified from the workshop include safety policy development-implementation-feedback alignment, tailored safety training programs for different project members from top management to frontline workers, and benchmark and application of safety best practice. We hope that the 10-step design thinking/co-production framework and the preliminary results presented in this paper provide a useful reference for researchers and practitioners to work together driving a change of safety culture and improve safety outcomes in construction.

Keywords: co-production, design thinking, construction safety, safety outcomes, safety culture, stakeholder.

¹⁵ patrick.zou@canberra.edu.au

INTRODUCTION AND RESEARCH AIMS

Construction is a very significant industry worldwide. For example it makes the fourth biggest contribution to Australian GDP (ABS, 2010). However, it is also one of the most dangerous industrial sectors, with accident and fatality rates consistently much higher than the all-industry average (Sunindijo and Zou 2014 and Zou and Sunindijo 2013). Safety on construction sites is, quite literally, a matter of life and death. Workers die and this has a broader impact on families and the community. For example, several fatalities occurred in 2012 in Canberra Australia, compelling the Territory Government to establish an enquiry to address safety issues on construction sites (ACT Government 2012). The enquiry report recommended that practitioners, industry and government work together to foster a strong safety culture on worksites and develop a strategic framework for workplace health and safety training, with clear priorities and evaluation (ACT Government, 2012). These points are also highlighted in the Australian Work Health and Safety Strategy 2012- 2022 (Safe Work Australia, 2012).

Most importantly of course, construction incidences cost lives, and affect families and the community, but there are also significant economic costs. Indeed, it has been estimated that, in economic terms, an accident can cost up to \$1.6 million, while a good safety management system may yield as much as a 46% return on investment (Zou et al., 2010). Unsurprisingly, given the importance of the issue, there has been considerable research on construction safety, for example, Zou and Sunindijo (2013), Gambatese et al (2013), Lingard et al, (2012), Bahn and Barratt-Pugh, (2012), Goh, et al. (2012), Mohamed and Chinda (2011).

The main foci of existing construction safety research has been on design, procurement, culture, technology, economics and construction site issues and how to develop and support a safety culture, particularly through effective training. For example, the relevant research coverage in the Australian universities could be summarised as: (1) designing for safety; procurement and client-led safety; group-level safety culture; building information modelling for safety; stakeholder and supply chain perspectives of safety; and supervisory practice for improving safety in construction (Wakefield, 2012). (2) return on investment in safety risk prevention and mitigation; safety risk assessment and mitigation at design stage; safety risk perceptions; fostering a strong safety culture; essential skills for managing safety; and research method and design in safety research (Zou and Sunindijo 2013).

There has also been a growing focus on the crucial question of how we can develop and assess project personnel's skills in relation to the management of safety. In essence, this approach builds on the observation that 90% of accidents on sites are attributable to human error (Lingard and Rowlinson, 2005). Here, Dingsdag et al (2006) developed a framework focusing on defining safety management tasks and how the implementation of such tasks can develop a safety culture. In a different, if related, vein, Zou and Sunindijo (2013) argue that there are conceptual, human, political and technical aspects of safety, all of which have to be addressed in training. More specifically, they identify self-awareness, visioning and sincerity as foundation skills, and social awareness, social astuteness and relationship management as the second-tier skills. Both the first tier and second tier skills need to be developed through training in order to improve both safety management and, more broadly, the safety climate. On the basis of their research, Zou and Sunindijo (2013) developed a

‘skills for safety’ model, which outlines the four aspects of conceptual, human, political and technical (as mentioned above), and the associated factors, that need to be addressed in safety training provided by the industry.

Most of the previous construction safety research has used survey and interview for collecting data (Zou et al 2011). The typical research process has been to design a survey questionnaire and/or a set of interview questions, then distribute the questionnaire to or conduct interviews with a selected sample. Data collected is then validated and analysed and results presented and discussed. In such process, there is virtually no involvement from the stakeholders of the construction practice community except answering some questions.

Considering the nature of construction safety management and the need to close the gap between theory and practice, there is a need to consider alternative research methods and research process (Zou et al 2011). This current research addresses this issue in an innovative way, using an approach increasingly common in public policy research, design thinking and co-production, which involves all stakeholders in the development of policy and implementation strategies, informed by relevant research and evidence (for an excellent review of this literature, see Alford, 2009). This approach is based on an understanding that it produces better policy (or program) and stakeholder ‘buy-in’ to its implementation. As such we are not undertaking research and producing findings which we then take to stakeholders. Rather, these stakeholders will be involved from the start of the research process.

Our research aim will be to develop a design thinking, co-produced model of the dimensions involved in construction safety and use it to inform the development of policy and regulations in the field and safety training programmes for those involved at all levels of the industry (such as government departments, regulators, unions, designers, head-contractors and sub-contractors). The main outcome of this research includes a new, co-produced ‘construction safety model’ which integrates different dimensions such as ‘attitude, skill, knowledge, behaviour and culture’, together with methodologies for their assessment, development and application. The new model will move the academic literature forward by integrating a focus on training for safety, which is the main concern in the extant literature, with a consideration of the role of government regulation.

RESEARCH APPROACH AND PROCESS

The knowledge co-production process proposed here is rooted in public policy design thinking, an approach that has been increasingly applied in public policy making and which was developed specifically to address the type of problem we face here: how can we design a policy-making process which enables research and reflection to support innovation in service design, policy programmes and governance practices? (for a review of the broad field see Alford and O’Flynn, 2012 and Alford, 2009). In the context of construction safety, this means involving key stakeholders when designing safety policy to co-produce new knowledge and framework, which then is implemented by the stakeholders. Three phases are involved in this approach; Establishing a shared representation of concerns and problems; Developing alternatives to existing practice and Integrating the research into practice and policy; and the process is iterative, requiring continuing engagement and reengagement between researchers and stakeholders in a process of co-production.

Phase 1: Establishing a Shared Representation of Concerns and Barriers

Step 1: Collecting the Evidence

The first phase of any design thinking involves an identification of the issues and problems and establishing a shared representation of concerns and problems with key stakeholders; in this case identifying the barriers to improve safety in construction. This step involves the research team summarising the extant literature in the area in a way which is accessible to stakeholders. More specifically, we focus on the work summarised above, with some attention given to the skills-for-safety model (Zou and Sunindijo 2013). We also provide evidence on the safety record on construction sites, taking care to consider the issue of ‘underreporting’. In this step, statistical quantitative data and methods is used on the effect of various factors on safety outcomes to inform the model development and discussions about changing safety practices and regulation. Furthermore system theory/approach is used to analyse relevant incident and accident data with an aim to reduce errors/injury. These summaries, together with the insights produced from the initial workshop, is a starting point for many of the discussion with stakeholders.

We have already undertaken the first step in this process by holding a preliminary half-day workshop with our key stakeholders, who have thus been involved in the development of the project; as emphasised, a key feature of design thinking and co-production. The results are reported in the later section.

Step 2: Examine the Barriers:

In this second workshop researchers and stakeholders will use the material produced in Step 1, and revisit the discussions in the first workshop, to examine the factors identified as barriers to research in the first workshop. The aim is to get a clear understanding of those barriers and begin to discuss how they might be addressed. Significant emphasis will be put on the differences in the various stakeholders’ perception of barriers, using evidence taken from extant research to begin to address and resolve those differences.

Phase 2: Developing Alternatives to Existing Practice

The second phase of any design process involves creating a space in which participants can imagine and develop steps towards a future, rather than becoming trapped in past models or ways of thinking (Boland and Collopy, 2004). This phase will use a creative design dynamic to encourage thinking about innovative solutions to the barriers identified in the first phase, in particular drawing on best practices.

Step 3: Further Evidence about Safety Procedures and Practices

The research will undertake a one-year ethnographic study in construction sites. This ethnographic study will focus on: analysing existing human resource development programs in relation to safety training; attending training sessions in the partner organisations’ head office and on construction sites; observing the ways in which project personnel and workers apply what they learn in training sessions to practice, by ‘shadowing’ targeted individuals; and, observing everyday practices on the construction sites. Standard ethnographic techniques will be employed, such as the ones described in Bryman (2008) and Pink, Tutt and Dainty (2012). This ethnographic study will enable us to uncover the influence of informal rules and norms on the process the operation of safety practices on work-sites and to explore the safety attitude and behaviour of the workforce.

Step 4: Evidence of Best Practice

Here, the research team will identify and analyse best practice in relation to safety policy and regulation: in the construction industry, both in other Australian jurisdictions and abroad; and in other relevant industries in Australia, notably mining and off-shore drilling. For example Transport Safety (Sweden's Vision Zero model) and Patient Safety, where there are well developed models, may be reviewed. This phase will draw upon the work of Evans, Marsh and others on policy transfer (Dolowitz and Marsh, 2012; Evans, 2010; Marsh and Evans, 2012), which identifies those factors which are likely to make such transfers effective, or not. Again this evidence will be fed into the design thinking process to provide an additional evidence base for the discussions.

Step 5: Providing Evidence of the Operation of the Safety Training Programme

The researchers will assess the effectiveness of training for construction safety programme. The aim here is to monitor and to improve the training provided. This is the essence of design thinking, rapid feedback from the research can lead to adjustments to the training programme in a dynamic way.

Step 6: Providing Evidence of the Regulation of Safety

Here, the researchers will examine the regulatory procedures and practices. This will involve scrutinising relevant documents and interviewing representatives of the industry, unions and the government.

Step 7: Addressing the Barriers

This workshop will consider the evidence collected in Steps 3, 4, 5 and 6. Here, the aim is to use that evidence to discuss the ways in which the barriers identified in Phase 1 can be addressed by using the data and information collected in phase two.

Phase 3: Integrating the Research into Practice and Policy

The third phase of any design processes involves embedding the outcomes of that process into practice. Here, the focus is upon developing a better model of construction safety, rooted in the outcomes of the co-production process, which will inform both an improved training programme and suggestions for improvement in the regulation regime and practices.

Step 8: Developing an Improved Construction Safety Model

On the basis of the prior research and the outcomes of the co-production process, we shall develop a new construction safety model which covers not merely issues of design and procurement, culture and training, common in extant models and discussion, but also other issues thrown up by the research, including regulatory issues.

Step 9 Integration of the Model into Organisational Practice

A workshop will focus on presenting and discussing the model and, more importantly, considering how we can embed our findings from the co-production process into practice. In relation to training, the workshop will focus on how the research partner's training programme, informed by the 'skills for safety' model, can be improved. To measure the improvement, the models developed by (1) Parker, Lawrie & Hudson (2006), "A framework for understanding the development of organisational safety culture"; (2) Lawrie, Parker and Husdon (2006) "Investigating employee perceptions of a framework of safety culture maturity" and (3) Zou (2013) "Total Safety Management" will be used. These discussions will be informed particularly by our

assessment of the current programme. In relation to regulation, the section will identify the regulatory and policy issues highlighted by the research, and the workshop solutions.

Step 10 Communicating the Results

Here the aim is to communicate the results of the research more widely into the construction 'community'. This will involve a series of presentations at industry forums, which will present the construction safety model and discuss the outcomes of the co-production process.

PRELIMINARY RESULTS

As discussed in the previous section, the aim of the first step of the design thinking and co-production process, is to evaluate the Zou and Sunindijo (2013)'s Skills for Safety model, and get a clear understanding of the barriers to improving safety in construction and begin to discuss how they might be addressed. As such, a cross-section of the construction and safety community were invited to participate in a focused group workshop "Getting Home Safely". The workshop was organised and run by the University of Canberra in partnership with the Master Builders Association, who as a strategic industry partner, expressed real concern the industry has around construction safety.

The Workshop Attendees

The invitees were carefully selected together with the Master Builders Association. These invitees represent Canberra's construction industry and included government policy makers, procurement officers, union's members, project managers, architects, consultants, engineers, safety consultants/certifiers, contractors and sub-contractors. Invitations were sent by emails. A total of 40 invitations were sent out and 21 participants accepted resulting in a 52.5% response. The attendees have on average 24 years of working experience, and most of them are in middle or senior managerial positions. The participants also represented a wide range of stakeholders in the construction supply chain, government officers, consultants, head contractors and subcontractors as well as safety advisor and professional institute representatives.

The Workshop Process

The workshop revolved around the design thinking and co-production process and method producing outcomes that could feed back into the research. The focus was not on the researcher gaining information then pass on to the construction industry, rather it was an iterative design thinking and coproduction process that drew on the knowledge, views and opinions of the industry participants through an interactive process, ensuring buy-in on the issues and ownership of the solutions by the industry.

A short introduction on the topic, aims, and process and expected outcomes of the workshop were first presented. Emphasis was given that without the input of industry knowledge and recommendations, policy makers do not have the feedback required to review and amend the current policies. Following this, an industry perspective to the current construction safety situation was provided to the audience, together with highlights of the importance of the construction industry working hand-in-hand with university researchers to improve construction safety.

Following the introductions, the first focus group session discussed the following: What are the barriers to achieving safety in the construction industry? These opening

comments set the scene for this first focus group session with participants responding with heated discussion about what they believed was the barriers of effective safety management.

After a short break, the “skills for safety” model by Zou and Sunindijo (2013) was introduced. This model includes four dimensions of skills, namely conceptual, human, political and technical, that are required to enable project managers to assess, develop and apply their skills for improving safety performance. The final session discussed the following: What policies, skills and tools are needed to further improve construction safety.

The Workshop Results

Several results have been achieved, including critiques on the Zou and Sunindijo (2013)'s “Skills for Safety” model, identified problems and barriers to construction safety and identified future research needs and specific areas.

Comments on the “Skills for Safety” Model

All participants agreed with the contents, structure and logics of the skills for safety model. They also agreed with the skill development strategies. However, they pointed out that one should not forget other players involved in the project particularly those on the first line – both managers and workers. They also pointed out that there is a need to looking into the skill set for government regulators who have the responsibility on safety policy and regulation making and implementation. For example, a head contracting general manager with over 20 years' experience agreed that the skills for safety model logic seemed sound, however he felt the challenge would be to explaining the model to industry individuals on how it could be applied to them. Another participant believed “people who are technical and logical thinkers need to be included in policy discussions”. This comment gets straight to the heart of what we are trying to achieve with co-production. He went on to say “workers on the ground need to be involved and listened to in WHS (work health and safety) to have some ownership”. A safety consultant who has over forty years of experience in the construction industry, believed the model provided a “wider perspective from builders/construction industry to the issue of safety” and expanded further by stating “safety is the responsibility of everyone, [from] top [management] to worker” which highlighted the need to focus on wider than the studied project managers.

Following such comments, participants indicated willingness to continue to support the research and agreed with such a co-production approach and they believe the research outcomes (i.e., a refined and improved construction safety model) generated from this approach and process will be more useful and practical to their practice and to improve construction safety outcomes and change construction safety culture. As such, we already have their ‘buy-in’ and agreement to participate in the research.

Barriers for Improving Construction Safety

A number of barriers were raised and discussed by the workshop participants, which have been summarised in Figure 1. The barriers are grouped into four categories, which are interrelated: organisation, cognitive, environment and operational.

In addition to the barriers discussion, it was generally agreed that people measures safety differently and a common safety vision needs to be developed and adopted as a way forward. Participants went on to express their frustration at the recent media attention Canberra has received via negative headlines regarding its safety

performance communicated the need to engage with media to communicate more human interest and success stories.

The feeling that workers should have an opinion and can provide valuable policy input was delivered in a frustrated and fervent voice from the contractors and sub-contractors in the room. The passion of the industry to improve construction safety was felt during the animated discussions that broke out around the room.

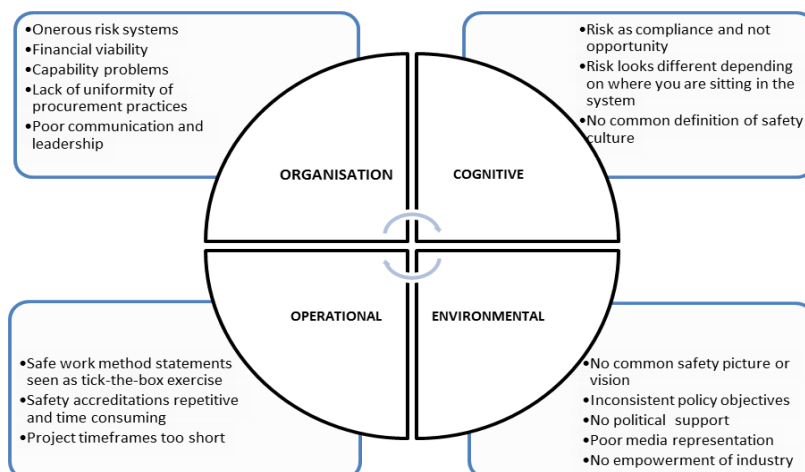

Figure 5: Barriers for Improving Construction Safety

The good news was a clear response from the policy representatives at the workshop that government would be keen to listen to the outcomes of the co-production process and would consider policy changes to meet the recommended outcomes.

Areas for Future Research and Action Plans

The following key themes were tabled as a starting point for further discussion:

- A balance of consultation is required between leadership and workers.
- The policies set by leadership have to recognise the need for involvement from all levels.
- Current training programmes are not effective on the ground.
- Current safety messages are inconsistent and need to have more involvement from the workforce.
- Learn from best practice within and outside the construction industry, nationally and internationally.

In order to build on the concerns and recommendations put forward by the industry participants, researchers will need to establish a clear path to move forward. The following key research agendas are identified as an invaluable feed into phases two and three of the design thinking and co-production process:

Policy development-implementation alignment: there is a need for constructive policy input from bottom up (i.e. stakeholder consultation) and clear policy interpretation from the top down. There is a need to change governance and change behaviour. Workers need to have involvement in policy development and a sense of ownership of the policies.

Safety skill training: one size does not fit all, there are needs for tailored training programs for different personnel. For example, training for workers may be focus on risk awareness; training for managers may focus on behaviour and skills development; and training for executives should focus on culture change.

Best safety practice: there is a need to focus on benchmarking best practice within the construction industry and from related industries such as mining and manufacturing, nationally and internationally.

CONCLUDING REMARKS

This paper contends that new research methodologies and processes are essential in order to achieve a change of construction safety culture and further improve construction safety outcomes. As such, design thinking and co-production is proposed to fulfil these needs. In the first focused group workshop, the participants were asked to identify what they saw as the barriers to safety in construction work. This process highlighted a number of issues that seem under-explored in the extant literature. In particular, they argued that there needs to be more focus on developing the skills of company executives, frontline managers and, especially, on-site workers, the latter curiously neglected in the literature, instead of focusing so much on project managerial personnel, as is the case in extant models. In addition, they emphasised the need to align regulation with both training and on-site practices. This workshop, of course, was only the initial step, which suggests some of the key, and sometimes neglected, dimensions involved in safety in construction, at least from the perspective of our stakeholders. It will provide one evidence-base for steps in the co-production process. Of course, these additional issues are likely to be covered in a new, improved, model, although it must be emphasised that the model will be developed through the process of co-production, so these suggestions as to the dimensions that will be covered, can only be indicative. Our next step is to continue implement the research proposal. In conclusion, we hope that the barriers and future research needs identified in this paper and the 10-step co-production approach in this paper offer some indication to academics/researchers and industry practitioners to work together to tackle the safety problem in the construction industry.

REFERENCES

- ABS (2010) 1350.0 - Australian Economic Indicators. Canberra: Australian Bureau of Statistics.
- ACT Government (2012) Getting Home Safely: Inquiry into Compliance with Work Health and Safety Requirements in the ACT's Construction Industry. Canberra: ACT Government.
- Alford, J (2009) Engaging Public Service Clients; From Service Delivery to Co-production (Basingstoke: Palgrave).
- Alford, J and O'Flynn, J (2012) Rethinking Public Service Delivery (Basingstoke: Palgrave).
- Bahn, S & Barratt-Pugh, LGB (2012) Evaluation of the mandatory Construction Induction Training program in Western Australia: Unanticipated consequences. "Evaluation and Program Planning", 35, 337-343.
- Boland, R J & Collopy, F (2004). Managing as Designing. Stanford, CA: Stanford University Press.
- Bryman A (2008) Social Research Methods, 3rd edition, Oxford University Press, 748 pages.
- Dingsdag, DP, Biggs, HC, Sheahan, V.L. and Cipolla, D.J. (2006) A Construction Safety Competency Framework: Improving OH&S Performance by Creating and Maintaining a Safety Culture. Cooperative Research Centre.

- Dolowitz, D & Marsh, D (2012) The future of policy transfer research. "Policy Studies Review", 10(3), 339-345.
- Evans, M (2010) *New Directions in the Study of Policy Transfer*. London: Routledge/Taylor and Francis.
- Gambatese, J, Hallowell, M, Renshaw, F, Quinn, M, and Heckel, P (2013) Prevention through Design: Research – The Power of Collaboration. "Professional Safety, Journal of the American Society of Safety Engineers (ASSE)", 58(1), 48-54.
- Goh, Y M, Love P, Stagbouer, G and Annesley C (2012) Dynamics of safety performance and culture: A group model building approach. "Accident Analysis & Prevention" 48, 118-125.
- Lawrie M., Parker D. and Hudson P (2006) Investigating employee perceptions of a framework of safety culture maternity, *Safety Science*, 44(2006) 259 - 276.
- Lingard, H & Rowlinson, S (2005) *Occupational Health and Safety in Construction Project Management*. Oxon: Spon Press.
- Lingard, H, Cooke, T and BLISMAS, N (2012) Designing for construction workers' occupational health and safety: A case study of socio-material complexity. "Construction Management and Economics", 30 (5), 367-382.
- Marsh, D & Evans, M (2012) Special Issue: Policy Transfer. "Policy Studies", 33(6), 477-591.
- Mohamed, S and Chinda, T (2011) System dynamics model of construction safety culture. "Journal of Engineering Construction and Architectural Management", 18(3), 266-281.
- Parker D, Lawrie M & Hudson PTW (2006) A framework for understanding the development of organisational safety culture. "Safety Science", 44(6), 551–562
- Pink, S, Tutt, D, & Dainty, A R J (2012) *Ethnographic Research in the Construction Industry*. London: Routledge.
- Safe Work Australia (2012) *Australian Work Health and Safety Strategy 2012- 2022*, 24 pages.
- Sunindijo, RY and Zou, PXW (2014) An integrated Framework for Strategic safety management in construction and engineering. In: "Achieving Sustainable Construction Health and Safety (W099)" 2014 conference.
- Wakefield, R (2012) Occupational health and safety in the construction industry from best practice to better practice. In: "CIB W099 International Conference on Modelling and Building Health and Safety", Singapore. 10-11 September.
- Zou PXW (2013) Chapter 7 Total Safety Management, in *Construction Management New Directions 3rd* by McGeorge and Zou, Wiley-Blackwell.
- Zou, P X W & Sunindijo, R Y (2013) Skills for managing construction safety risks, implementing safety tasks and developing positive safety climate. "Automation in Construction" , 34 (2013), 92-100.
- Zou, P X W, Sun, A C S, Long, B, & Marix-Evans, P (2010) Return on investment of safety risk management system in construction. In: "CIB World Congress", Salford Manchester UK, 11-13 May.
- Zou, P X W, Sunindijo, R Y, & Dainty, A R J (2011) Review of construction safety research methods: Integrating theory and practice. In: "ARCOM conference", Bristol, UK. 5-7 September.

Designing for health and safety

DESIGNER'S PERCEPTIONS OF SAFE DESIGN AND ITS POTENTIAL FOR INNOVATION

Ronan McAleenan¹⁶ and Michael Behm

¹Occupational Safety Program, East Carolina University, Greenville, NC USA

The concept of safe design may be considered an aid or a hindrance to designers. The extent to which safe design is implemented, its timing within the design process, and the tools and processes employed could well be related to designers' perceptions. If the designers' fundamental tenet is their technological and intellectual disposition is to prepare and execute safe designs then the core question has to be, do designers view safe design as a pleasure or a pain? This study focuses on designers from the United Kingdom and Australian since 'design safety' legislation has been implemented there for several years and both jurisdictions provide an element of guidance on safe design practices. The purpose of the study is to determine if thinking about worker safety in the design process enables or restricts innovation and creativity in the design process. The analysis will compare safe design approaches in the two regions to see if there is any correlation between them. The thoughts and practices of designers from the both countries are explored to determine, among other things, their perceptions of the value of safe design. The primary methodology for this study is a questionnaire, followed up with a more detailed interview, conducted on a sample group, comprising design engineers and architects across a range of industries, with differing levels of experience. The expectation is to find some innovations that stem from the safe design process. The expected results could impact the view of safe design and safe design regulation, particularly useful in the year that United Kingdom is reviewing its approach to regulating construction, design and management.

Keywords: safe design, design process, innovation, construction, management.

INTRODUCTION

The concept of safe design has been a legislated procedure in the United Kingdom and Australia since the early 1990's. But it is only recently that it is being considered a tool that can be used in the design phase for innovative practices in the life cycle of the structure. This paper aims to look at whether the idea that safe design can be used as a form of innovation is instilled in the professionals that use these regulations and legislations on a daily basis or whether it is still simply considered another exercise that hinders how they design structures causing more problems than it solves.

The United Kingdom and Australia were used in this study because of the length of time that legislations have been implemented in these countries. Alongside looking at these two regions, this study will look at the comparisons between civil engineers and architects opinions on the safe design regulations.

¹⁶ mcaleenanr12@students.ecu.edu

LITERATURE REVIEW

In Europe, safe design legislation was born out of European Foundation for the Improvement of Living and Working Conditions (1991) document “From Drawing Board to Building Site”. This document highlighted the need for better planning, management, and design of the built environment to positively affect a range of business conditions within the construction sector. This document is frequently cited in the archival literature and led to the Temporary and Mobile Construction Sites Directive of 1992 which, in Europe, placed legislative duties on designers (Anderson, 2000). In the United Kingdom safe design is regulated through the Construction Design and Management (CDM) regulations. CDM is currently undergoing review and revisions are planned for 2015. In Australia, several State regulations require design professionals to consider how their design is to be safely constructed (Bluff, 2003). Behm and Culvenor (2011) surveyed designers in Western Australia to understand their view of the safe design regulations. Their results provide several examples which demonstrate that thinking about safety in the design yield innovative new designs that are also good for business value. This is the basis for our inquiry.

In order to determine whether safe design can properly be used as a tool for innovation the first question that must be considered is what is innovation itself? When considering innovation within the construction industry Ling et al (2003) defined it as “a new idea that is implemented in a construction project with the intention of deriving additional benefits”. This statement was backed up by Asad et al (2005) when they stated that innovation is a “pre-requisite to any competitive advantage”. Innovation should be designed to give advantages to both the individual and the organization as a whole. It is considered one of the leading factors that bring success to a company whether it is in the company’s products, processes, services or organizational ideas. Innovation is seen by Asad et al (2005) to have increasing importance in the construction industry with companies needing “to innovate in order to adapt continuously to complex and changing conditions”.

Culvenor (2000) maintains that there are three basic steps to making workplace safety a creative process. These include “proactive thinking, divergent thinking and judicial thinking”. Proactive thinking focuses on prevention and planning. Divergent thinking relies on breaking the “habit gravity” which is currently being motivated by negative outcomes such as “guilt; legal sanctions; and monetary loss”. Judicial thinking focuses on the “practicability” of the safe aspect. It is asserted by Culvenor (2000) that current health and safety laws are “overly prescriptive, impossible to keep current, too numerous, and too hard for people to access and understand”.

Culvenor (2000) proposes that as “most hazards don’t occur naturally” and they come about as part of the design process that therefore the control of the hazards has its priority in the “elimination” in the design phase. It was previously stated by Culvenor in his earlier paper (1996) that “the first problem lies with the common understanding of the word accident.” Although that it is perceived that accidents cannot be prevented as they are “unexpected”, “unfortunate”, “unplanned”, “unintended” or “uncontrolled” this may be misleading. Culvenor (1996) believes that figures relating to unsafe acts causing accidents may be misleading and manipulated.

Newton (1999) believes that construction innovation could be considered as a “fourth performance dimension” in the industry and that it could be ranked alongside “cost, quality and time”. Innovation is seen to be essential by clients because of the increasing pressure for the improvement of “quality, reduce costs and speed up construction process”.

There are a number of different types of innovators that can be considered. Sniderman (2012) includes movers and shakers; controllers; star pupils; experimenters; and hangers-on. The ‘movers and shakers’ are those who lead that groups and tend to have a “strong personal drive”. The ‘controllers’ tend to shy away from risks and like to be in control of their own domain. ‘Star pupils’ are those who are seen “seeking out and cultivating the best mentors” and take pride with the work that they put into projects. ‘Experimenters’ are often described as “persistent and open to all new things”. The ‘hangers-on’ have the job of bringing “everyone back down to earth”.

Innovation in the construction industry can be broken down into ‘organizational innovation’ and ‘technical innovation’. These two types of innovation are very different. The ‘organizational innovation’ takes place throughout the structure of the company. Asad et al (2005) says the ‘organization innovation’ is led by “advanced management techniques and implementation of new corporate strategic orientations”. Whereas the ‘technical innovation’ is part of the product that is being produced by the company or the process in which the product is produced.

Regardless of whether the innovation is organizational or technical there are two types of innovation, radical and incremental. Radical is in response to a crisis or pressures from external pressures, where incremental is through step-by-step changes, this is the more common of the types of innovation.

Asad et al. (2005) state that innovative comes in three different forms, including integrative, appropriate and contingency. Integrative looks at the management of innovations using interdisciplinary and multifunctional resources. Appropriate considers different viewpoints should be taken into account. While contingency considers each solution depending on the situation.

Corona et al. (2005) discusses the difficulty of measuring innovation and how to measure it objectively. Innovation should be defined as “a change, which leads to obtain improvements”. Griffin and Page (1996) developed and proposed a series of indicators to measure the success or failure in the development of a new product or method. This method is based on a series of aspects of management, “project strategy, business strategy, level of project measures and level of company measure”.

It is believed that safe place controls give a mechanism of prevention that is more reliable. Culvenor (2000) states that “thinking out” safety problems are considered a more effective term than “engineering out”. The reason for this is that it gives more creative freedom for designers.

METHODOLOGY

The purpose of the study is to explore the opinions and experiences of UK and Australian architects and civil engineers focusing on their opinion of safe design and its potential as a source for innovation. This study aims to see where the differences of opinion occur and from this further studies can be determined to see why the differences occur.

In order to conduct this study the primary method for data collection is an anonymous online questionnaire. The survey was anonymous so that the professionals could voice their true opinions on the safe design process. The questionnaires were broken down into three sections in order to be able to split the analysis down more accurately. The first section was background information including the discipline, the years of experience they have and the type of industries that the experience is in. The second section looks at whether or not the civil engineers and architects received formal education on safe design processes and where it was received. It also asks whether they consider the education encouraged safe design. The third section addresses whether or not the designers feel that safe design is an incentive for budget and time, and if they consider that their professional body encourages safe design principals.

The reasoning behind choosing an online questionnaire over a focus group is that the opinions of the civil engineers and architects are not influenced and biased by the others in the group. Travel, costs, and overall logistics were a limiting factor in this decision as well.

These surveys were then followed up with interviews from those who took the questionnaire and were then willing to give more detailed opinions on the safe design process. This proceedings paper focuses on the survey results.

The population is made up of a range of civil engineers and architects from the UK and Australia. The method of gathering the population is through snowball sampling. Contacts that have been gathered professionally were sent the survey and with the email they were asked to send the link onto those they thought would fit into the predetermined criteria.

Independent variables included;

- Discipline – Civil Engineer / Architect
- Country – UK / Australia
- Design vs design-build
- 0-14 years vs 15+ years
- Conceptual design – yes / no
- Formal education – yes / no

Dependent variables (measured on a 5 point Likert scale) included;

- Safe design is a good incentive in terms of my time?
- Safe design is a good incentive in terms of my budget?
- Training/education prepared me for implementing safe design?
- Training/education encouraged me to be creative?

The study methodology was approved by the authors' University Institutional Review Board (UMCIRB 13-001058). Data was analysed using SPSS. Categorical relationships were analysed using chi-square tests. Although the level of significance is generally 0.05, due to the number of people that took the survey, p-values < 0.10 are discussed in the Results section as they offer insight into areas of potential interest. So in this case some values will be considered because they are tending towards significance so these values can be considered to be of some usefulness.

RESULTS

Table 4 - Civil engineer and architects breakdown

	UK	Australia	Total
Civil Engineers	42	19	61
Architects	19	10	29
Total	61	29	90

Table 5 - Years completed

Years Completed	Count
0-4	15
5-9	13
10-14	13
15+	49

Table 6 - Industry

Industry Type	Count
Commercial	34
Industrial	18
Heavy Civil	36
Residential	25
Other	22

Table 7 - Formal training received

Did you receive formal training for safe design?	Count
Yes	48
No	42

The tables above show the demographic of the designers that took part in the survey. Table 1 shows the split between civil engineers and architects and how they are split between UK and Australia. Table 2 demonstrates the respondents' range of years of experience. It can be seen that more than half the respondents have 15 or more years of experiences. In Table 3 the industry in which the designers have experience in is shown. There is a wide range of industries that they have designed in from commercial to residential, including areas such as transport, infrastructure, hospitality and tower crane industry.

Architect – Civil Engineer comparison

- Architects feel that safe design has more of a negative influence in design creativity compared to civil engineers ($p=0.002$). Specifically, within the United Kingdom, civil engineers feel that safe design has more of a positive influence on innovation and design creativity compared to architects ($p=0.031$). There was no relationship among the Australian designers.
- Civil engineers agree that safe design is a good incentive in terms of time compared with architects ($p=0.095$).
- Architects implement safe design at the conceptual stage more so than civil engineers ($p=0.095$).

When comparing architects and civil engineers the first thing that can be seen from the results is that architects feel that safe design has more of a negative influence in design creativity compared to civil engineers. This is reiterated by James Richie (2006), the past-President of the Association for Project Safety, when he said that there is “a sluggishness on the part of many designers to pay due regard to health and safety”.

Even though this is the case, architects implement safe design into their design process at an earlier stage than civil engineers. Theoretically, there is a greater potential to influence safety the earlier in the design process. Behm et al. (2014) adapted Szymberski's time-safety influence chart (See Figure 1) with the ability to utilize the hierarchy of controls, and specifically to eliminate, substitute, and engineer to reduce hazards. They go on to claim that these higher order controls present the opportunity to be innovative and creative with designs; this impacts worker safety but also traditional business measures. An example is provided from a Western Australia design and engineering firm where, through a design change, falls from height were reduced by 95% and the schedule was reduced by 10 days (Behm and Culvenor, 2011).

Architects, in this study, implement safe design processes earlier during the design stage. However, this may mean that there may not be the opportunity or the opportunity is not being fully utilized to identify site specific risks; there may not be enough information or the safe design processes may not be refined to identify hazards in the conceptual stage. On the other hand, civil engineers are involved in the detailed design and the construction process. The involvement of the safe design process later during the design stage may allow civil engineers to identify where safe design may be utilised to its full potential, which may explain why they are more positive.

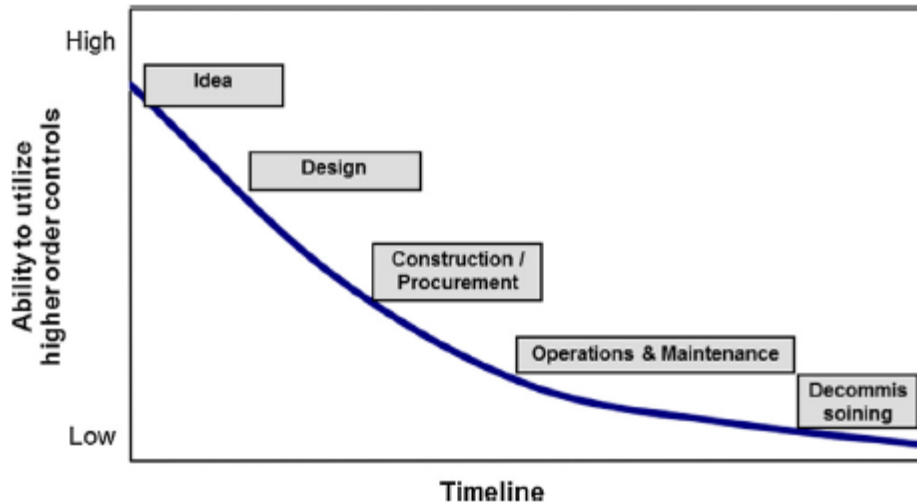

Figure 6 - Ability to effectively utilize the hierarchy of controls (Behm et al., 2014)

Regarding safe design and determining whether it is a good incentive in terms of time the civil engineers tend to agree that safe design is a better incentive in terms of time more so than the architects. Bresnen & Marshall (2000) also said that “performance in terms of ... time ... can be dramatically improved if participants adopt more collaborative ways of working”.

Tatum (1991) states that one possible reason for this belief is because “engineering and construction firms need to innovate to win projects”, this would leave more of an impact with civil engineers to feel that safe design is helping them with innovative processes that does win projects, rather than architects who do not feel that the development of innovative processes is an important factor in the stages of design.

UK – Australia comparison

- Australian designers consider safe design a good incentive in terms of budget more so than designers in the United Kingdom ($p=0.028$).

This is an interesting result; the regulations in the United Kingdom are currently being revised for the second time in seven years whereas the Australian regulations have not been revised for several years. This may be due to promotion of “safe design in Australia has a longer history than the regulations” (Behm and Culvenor, 2011). Behm and Culvenor (2011) found that in Western Australia design engineers were found to be generally supportive of the safe design concept and that the regulations were sensible.

CONCLUSIONS

This study plans to be continued using interviews from people who have stated through the anonymous survey that they are willing to participate in a follow-up interview. The aims of these interviews are to see what specific examples civil engineers and architects have where the safe design legislations have had an effect of their innovation in the design process. One problem that may be experienced is the lack of people who feel that safe design legislations may have a negative effect on their innovative possibilities. This may be due to a fear that they will become culpable for what they have said.

If this study would be repeated the one major thing that would be changed is the number of people that completed the surveys. This could explain why some of the p values that were calculated were not statistically significant, but they were tending towards significance.

From the results gathered in this study future research could determine the reasoning behind the differences of opinion between United Kingdom and Australia in terms of budget. Also the differences of opinion between civil engineers and architects on whether safe design is a positive or negative influence and at what point safe design practises are implemented in the design process. One possible reason for this difference could be educational differences.

In a professional surrounding it is hoped that this study can show that there is a potential for safe design legislations to be used to increase innovation in the design process, both by civil engineers and architects. It can be seen that there are certain gaps where the implementation of safe design can be improved. There may be gaps in education where designers can be taught that the safe design regulations can be used to aid their design process rather than just being a process that they just need to complete during design and hinders their progress (Corona Armenta and Boly, 2005)

REFEENCES

- Anderson, J. (2000). Finding the legislative framework for guiding designers on their health and safety responsibilities. *Design for Safety and Health Conference* (pp. 143-150). London: C.I.B Working Commission W99 and the European Construction Institute.
- Asad, S., Pan, W., Fuller, P., & Dainty, A. R. (2005). *Learning to Innovation in Construction: A Case Study*. Birmingham & Loughborough.
- Behm, M., & Culvenor, J. (2011). Safe Design in Construction: Perceptions of Engineers in Western Australia. *J Health & Safety Research & Practise*, 3(1), 9-32.
- Behm, M., Culvenor, J., & Dixon, G. (2014). Development of Safe Design Thinking among Engineering Studnets. *Safety Science*, 63, 1-7.
- Bluff, L. (2003). Regulating safe design and planning of construction works: a review of strategies for regulating OHS in the design and planning of buildings, structures and other construction projects. *The Australian National University, Canberra*.
- Bresnen, M., & Marshall, N. (2000). Partnering in construction: A critical review of issues, problems and dilemmas. *Construction Management and Economics*, 229-237.
- Corona Armenta, J. R., & Boly, V. (2005). *How to Measure the Innovation Processes Capacity*. Nancy: Equipe de Recherche sur les Processus Innovatifs.
- Culvenor, J. (1996). *Safe Place versus Safe People*. University of Ballarat.
- Culvenor, J. (2000). *From Prevention to Innovation*. Melbourne: Safety In Action.
- (1991). *From Drawing Board to Building Site (EF/88/17/FR)*. Dublin: European Foundation for the Improvement of Living and Working Conditions.
- Griffin, A., & Page, A. (1996). PDMA success management project: recommended measures for product development success and failure. *Journal of Product Innovation Management*, 478-496.
- Hunter, W. (2006, April 13). *Safe Design is Good Design*. Retrieved January 29, 2013, from Building.co.uk: <http://www.building.co.uk/safe-design-is-good-design/3065901.article>

- Ling, Y., Dulaimi, M., & Bajracharya, A. (2003). Organizational motivation and inter-organizational interaction in construction innovation in Singapore. *Construction Management and Economics*, 307-18.
- Newton, P. (1999). *Modelling Innovation in AEC: Understanding the Forth Dimension of Competition*. Berkeley: University of California, Berkeley.
- Sniderman, B. (2012). The Five Personalities of Innovators: Which One Are You? *Forbes*.
- Tatum, C. (1991). Incentives for technological innovation in construction. *American Society of Civil Engineers*, (pp. 447-52). New York.

HEALTHY CONSTRUCTION WORKERS BY BETTER WORKPLACE DESIGN

Stephanie Eaves¹⁷, Dr. Diane Gyi and Prof. Alistair Gibb²

¹ *Loughborough Design School, Loughborough University, Leicestershire, UK, LE11 3TU*

² *School of Civil and Building Engineering, Loughborough University, Leicestershire, UK, LE11 3TU*

The construction industry is renowned for heavy, manual work and being tough on the well-being and health of those who work in it. With the recent abolishment of the retirement age in the UK, there is a call for research enabling safer, healthier, longer working lives. This is particularly important in the construction industry, where musculoskeletal symptoms are common and harsh conditions prevail and yet it seems to be accepted that injury and hard work go hand in hand. This research harnesses the knowledge and experience of construction workers, regarding their opinions of the design of the workplace and their health at work. The research hypothesis is that, using this knowledge and experience, healthy behaviours can be facilitated by good design. Semi-structured, in-depth interviews lasting approximately 30 minutes are being used with trades that require twisting, turning, heavy lifting and working in cramped and awkward positions such as electricians, bricklayers, joiners and plasterers. Workers are being asked about the difficulty of their job, their health at work and their opinions and ideas about the design of the workplace. Observations are recorded in the workplace to triangulate data and evidence issues raised in interviews. Preliminary findings are presented in this paper, which are being used for a PhD study investigating ageing workers within the construction industry funded by Age UK. These findings will be presented to stakeholders within the construction industry such as line managers and health and safety professionals, with a view to developing sustainable solutions in the construction industry enabling healthier working lives.

Keywords: design, ergonomics, participatory ergonomics, older workers, workplace design.

INTRODUCTION

We are living in an increasingly ageing population and as a result we are seeing an increase in an ageing workforce (Aviva 2013; Frommert et al. 2009). With the poor economic climate in the wake of a recession, many older workers are having to work for longer; an issue which has only been worsened by the abolishment of a retirement age (BBC 2011; BBC 2013). Despite this, working into later life has suggested benefits such as maintenance of a social network, providing a sense of purpose and keeping the negative effects of retirement at bay such as the development of cardiovascular disease and social isolation (Holcomb 2010; Behncke 2012). Nevertheless, remaining in work in some occupations can be difficult and in extreme cases, impossible due to musculoskeletal symptoms in the back, knees, neck and shoulders, particularly for heavy manual work seen in the construction industry.

¹⁷ S.Eaves@lboro.ac.uk

The construction industry is well known for being tough, with work often being in dark and cold environments with little ventilation. Heavy tools, lifting, twisting and turning are also common place. These factors can be contributors to illness and disability in later life. As we age our bodies degenerate; the lenses of the eyes become harder, making it more difficult to focus and our hearing ability decreases, particularly in the speech ranges making conversation more difficult (Beers & Van der Heijde 1996; Brant & Fozard 1990). Mobility decreases as muscles become weaker and joints become stiffer, particularly in the morning (Holviala et al. 2012; Badley & Tennant 1992).

In jobs requiring strength and stamina, the effects of ageing become even more apparent and are exacerbated in many cases. It has been reported that up to 63% of retired workers in construction have had to leave due to medical conditions, despite wanting to remain in work (Arndt et al. 1996). Particular musculoskeletal disorders have been attributed to certain trades, due to the type of work they are required to do. Carpenters can suffer from increased back, neck and shoulder problems and bricklayers and plasterers are known to suffer from dermatitis, as a result of prolonged exposure to cement and plaster (Albers et al. 1997; Boschman et al. 2011).

Despite these issues faced by construction workers, it has been reported that they want to remain in work for longer (Leaviss et al. 2008). As a result of this, there is an increasing need for research to ensure that the workplace is suitable to accommodate the rapid increase in the ageing workforce; workplace design can play a large part in ensuring this happens, meaning that workers are able to remain in their jobs for longer.

This research hypothesises that the experience and knowledge of older construction workers can be harnessed to improve the design of the workplace, facilitating healthy working behaviours. It is part of a larger PhD project, funded by Age UK's 'Research into Ageing Fund'. This paper provides the methodology used for the first phase of data collection and preliminary observations from a pilot study of 10 semi-structured interviews with construction workers.

Research Methodology

Over a period of seven months from May to November 2013, semi structured interviews were conducted with construction workers across a number of sites. Participants were recruited through professional and personal contacts in the construction industry, with site managers arranging suitable, English speaking workers in certain trades. Trades of particular interest were plasterers, electricians, bricklayers, plumbers, and carpenters/joiners due to the repetitive movement, heavy lifting and awkward cramped positions required for their jobs. Due to the peripatetic nature of the construction sites, these trades were not always available for interview; other trades interviewed included ground workers, steel fixers and scaffolders as these trades still required heavy lifting, twisting and turning. A stratified sample of 80 construction workers was to be interviewed, from age groupings of under 25, 25-34, 35-49 and 50+.

Throughout the pilot study, in-depth semi-structured interviews took place on site with ten participants. A framework interview schedule was followed (table 1), which allowed the investigator to prompt the participants when needed but largely allowed the participants to discuss topics at length. Participants were asked demographic questions regarding their age, trade, employer and how long they had worked in their

job. This was followed by an open discussion about their job and the difficulties faced, such as being in awkward and cramped positions, heavy lifting, use of tools and personal protective equipment (PPE) and working either indoors or outdoors. The Stage of Change Questionnaire (Whysall et al. 2007), was used as a basis for this, encouraging discussion around ideas for changes to their working environment, the equipment they use, personal protective equipment and any changes made by their employers. Examples of previous design suggestions were given if participants appeared to be struggling to grasp the concept of ‘better workplace design’, such as changes to tool design or in-situ adaptations to their working environments.

Table 1: A summary of the questions asked during the interviews

	Questions and issues
Demographics	Age range. Occupation. Employer. Time spent in employment
Their Job	Everyday tasks? Tools and equipment used? PPE requirements and usage? Location of job? Awkward/cramped positions? Use of chemicals? Is there dust, noise? Working inside, outside?
Ideas and Current Changes	What ideas do you have to make your job easier? To make the workplace better? New/different equipment? Flooring, lighting, PPE, talks, workshops, job rotation, micro-breaks, better facilities? What advice would you give to a younger worker? What would you do differently? E.g Plasterer - how do you cope with the weight of the trowel and wet plaster? Electricians- what do you do about extra lighting in smaller areas? Bricklayers- what issues do you face with working outside? The weather?
Health	Stage of Change Questionnaire (Prochaska and DiClemente 1983) Nordic Musculoskeletal Questionnaire (Kuorinka et al 1987) Work Ability Index (Ilmarinen et al 1991)

Adapted versions of both the Nordic Musculoskeletal Questionnaire (Gyi et al. 2013) and the Work Ability Index (de Zwart et al. 2002) were used within the interviews to provide quantitative data. The Nordic Musculoskeletal Questionnaire was used to assess point (7 day) and period prevalence (12 month) of any musculoskeletal symptoms being experienced as a result of the participants' jobs. The Work Ability Index was used to assess the workers' perception of their mental and physical ability to work. These two questionnaires also facilitated further discussion about design of the workplace if specific musculoskeletal symptoms were identified, for example “you’re experiencing back pain as a result of your job, so what do you think could be done to reduce this?”

Data collection methods were approved by the University Ethics Committee. Participants were fully informed of data collection methods and given an information sheet to read before signing the consent form prior to the interview. Interviews lasted approximately 20-30 minutes and were recorded using a Dictaphone. To triangulate the data, observations were carried out on site where possible with photographs and videos being taken.

Preliminary observations from a pilot study of the first ten interviews will be reported in this paper.

Preliminary Observations

The preliminary observations come from a pilot study conducted on a site in London from a medium sized organisation. Ten participants were interviewed; table 2 shows the participant profiles.

Table 2: Trades and ages of participants from pilot study

Age Range	Under 25	25-34	35-49	50+
Trade				
Bricklayer				2
Plumber				1
Electrician	1	1	2	
Carpenter/Joiner			1	
Scaffolder			1	
Painter & Decorator		1		

The average length of the interviews was 26 minutes and they were held in a meeting room on site.

A strong outcome from the interviews was that workers expected to experience aches and pains as part of their job. As a result of this, they felt that it was something that could not be changed and was not a matter of importance;

“this shoulder doesn't really feel any pain, it's used to it” (35-49, scaffolder)

“at the end of the day that's just what happens” (35-49, electrician)

“you just get used to it over the years” (50+, plumber)

“I've done it all my life, so I'm used to it” (50+, bricklayer)

A small number of the participants had actively made changes to their work environment in order to protect their health. Interestingly, it was the youngest participant, a 21 year old female apprentice electrician, who seemed to have made the most conscientious effort to protect her back whilst at work:

“Sometimes I get a cable drum to sit on...so that I can sit up straight... 'cos I get back ache...I might put my bag behind it as well so it's straight” (Under 25, electrician)

Other workers had also made changes;

“if you were working on sockets you'd make up knee boards for yourself, out of polystyrene and stuff like that...you use whatever's in your environment to make it comfortable for yourself” (35-49, carpenter)

“people will have gloves with these two [fingers], just the tops cut off...so you can hold [screws]” (35-49, electrician)

It also became apparent throughout the interviews that the main form of protection for the workers was their personal protective equipment (PPE). They believed that the changes in PPE have made their work safer, and this has also protected their long-term health as well as prevention of injury, such as the use of dust masks, hard hats and goggles. When participants were asked if they do anything to consciously protect their

health at work, all ten referred to PPE first. It is interesting that PPE is considered to be so significant by workers despite being at the bottom of most accepted risk management hierarchies (HSE 2011).

When asked questions from the Stage of Change questionnaire, 50% of the ten workers believed that changes needed to be made in the next six months in order to reduce the risks of aches and pains developed at work, suggesting that these individuals were in the contemplation stage. Suggestions for changes included a reliable electric drill for electricians when working on sockets to reduce wrist strain. Of the five workers who believed changes need to be made, four believed that these needed to be made in the upcoming month or two, indicating that they were more prepared to make alterations, putting them in the determination stage of change. Those who were in the action or maintenance stage had already made changes such as attending health and safety and manual handling courses, being more mindful of their posture when lifting and slowing down their working pace to protect their body.

Musculoskeletal symptoms were most commonly experienced in the knees (figure 1) with 90% of workers confirming experiences of these in the last 12 months. The only worker who did not experience any musculoskeletal symptoms in the knees was the painter and decorator. The second most reported site for symptoms was the wrists and hands, of which all the electricians had felt symptoms in the past 12 months. There was only one worker who had experienced musculoskeletal symptoms in the hips, thighs and buttocks however he reported that this was unrelated to work.

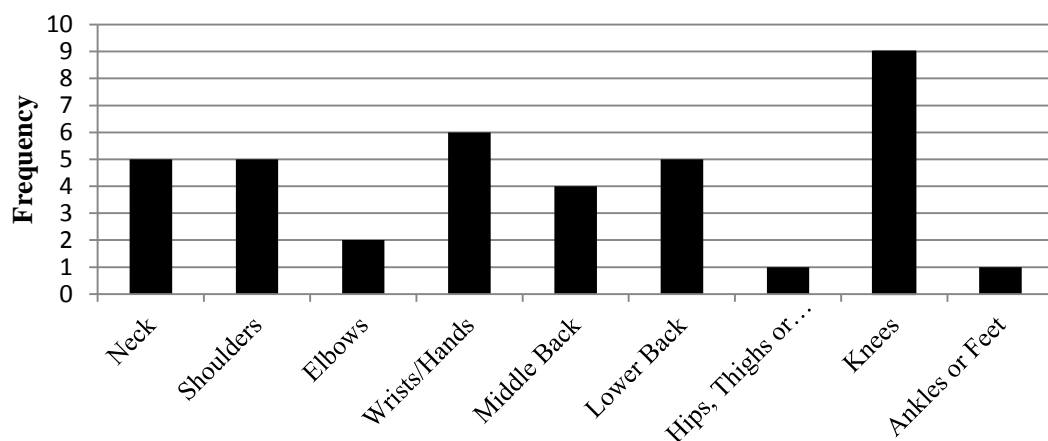

Figure 1: Musculoskeletal symptoms experienced in last 12 months

Of the workers who had experienced musculoskeletal symptoms in their knees, 77% believed this was related to their work (figure 2); however two participants said this was not related to work and instead attributed these symptoms to either activities outside of work such as playing football or old age in general.

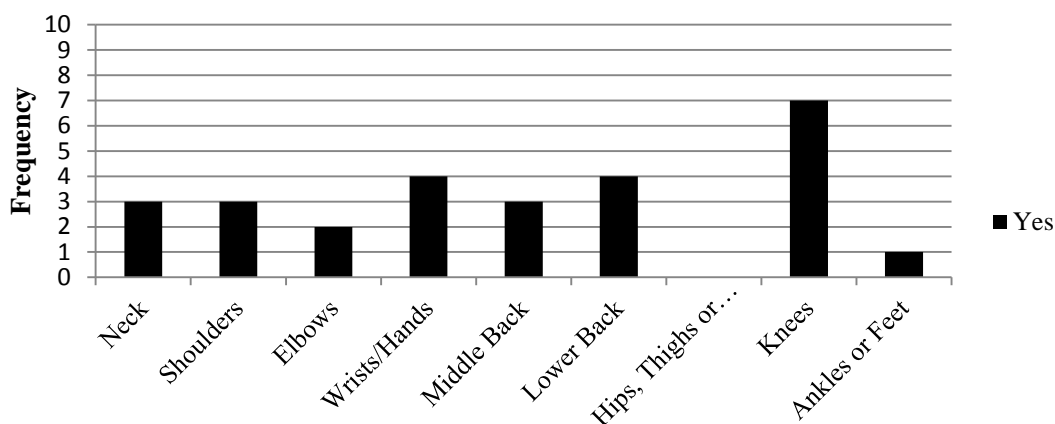

Figure 2: Musculoskeletal symptoms related to work

The number of musculoskeletal symptoms in terms of sites on the body was highest for the workers aged under 25 and the lowest number of reported musculoskeletal symptoms were found between the ages of 25-34. The high number of musculoskeletal symptoms in the youngest age group was attributed to the worker having a “*really bad posture*” which caused them to change their working environment and also causes of aches and pains outside of work, which were being transferred into their working day such as neck pain “*I don’t know if it’s from work or if I sleep funny*”. Electricians reported the highest number of musculoskeletal symptoms (n=4) and the painter and decorator, plumber, scaffolder and carpenter reported the lowest (n=1). Electricians attributed these symptoms to having to do a lot of kneeling for lower level sockets whilst not wearing adequate knee protection and also repetitive movement such as using a manual screwdriver when second fixing. Workers with a lower frequency of musculoskeletal symptoms attributed these to the temporary nature of the job, variations of tasks, taking care when lifting heavy loads and being in the trade for a substantial period of time, therefore becoming ‘numb’ to any aches and pains.

The Work Ability Index Questionnaire showed that all ten participants believed the demands of their job were both mental and physical, with all participants rating their workability as ‘rather good’ or ‘very good’ for both of these demands. When asked to rate their current work ability on a scale of 0-10, with 0 as completely unable to work and 10 as working at their lifetime best, all participants rated themselves at 7 or above, with 60% rating their ability at 8 and 30% at 10. The highest work ability rating of 9 was in the 25-34 age range and the lowest of 7 was in the age range of under-25.

Limitations

A number of different trades were interviewed due to the peripatetic nature of construction sites, however it was ensured that these trades required heavy lifting, being in awkward or cramped positions or repetitive movements. Many of the construction workers were “on price” meaning that they were paid in accordance with how quickly they completed the job, this may have had an effect on how much thought was put into their responses during the interviews, due to a keenness to return to work. The nature of the interview was retrospective, meaning that workers were being asked to think about issues they may have faced previously. On several

occasions workers admitted that they had thought of ways of improving their workplace tasks in the past, but were unable to think of what these were at the time of the interview, meaning that the interviews yielded less depth in terms of detail. On occasions, workers were led to believe by their peers on site that the interviewer was a Health and Safety professional looking to ensure rules and regulations were being followed, this led to participants feeling uncomfortable to begin with, which may have affected the quality of the interview or the openness of the participant.

CONCLUSION

The outcome of this research is to improve the quality of life for older workers in the construction industry, by harnessing the knowledge and experience of workers to facilitate healthy working behaviours. The pilot study supports the following:

- Participants demonstrated their awareness, knowledge and experience of the risks of working in the construction industry.
- Despite claiming that aches and pains were a part of their job and stating that they were not overly concerned about these risks, participants still appeared to be making conscious changes in order to protect themselves from further injury which may have a negative effect on their career.

This research is on-going with the next step being to complete the analysis of the full data set of interviews from the sample of 80 construction workers. This analysis will then be presented to stakeholders in the industry such as site and project managers, health and safety officials and occupational health professionals. This phase of the research is embedded in a participatory approach, which has been shown to be successful across a number of projects (Wilson 1995; Vink, Urlings & van der Molen 1997; Loch et al 2010).

Initiatives such as ‘train the trainer’, where the information comes from within the organisation, training older, more experienced workers to transfer their knowledge and experience to younger apprentices early in their careers and looking at ways the workers in the organisation can be fully involved in design decisions will all be investigated in the next phase of the research. By providing workers with a sense of ownership and naming ‘ergonomics champions’ within the workplace for those who have demonstrated good practice, better workplace design can be facilitated. It is hoped that this will then encourage healthy working behaviours and safer practices in industry, encouraging workers to be more diligent and share healthy working ideas with one another. This will also pave the way for these initiatives to be continued without the presence of an ‘ergonomics expert’ (Wilson 1995). This research also provides support for future researchers investigating health and safety within construction and provides a sound basis for the concept of participatory ergonomics within the workplace and health and safety interventions.

ACKNOWLEDGEMENTS

The authors would like to acknowledge Age UK’s ‘Research into Ageing Fund’ and Loughborough University for funding this PhD studentship.

REFERENCES

- Albers, J, Li, Y, Lemasters, G, Sprague, S, Stinson, R, and Bhattacharya, A (1997) An Ergonomic Education and Evaluation Program for Apprentice Carpenters. “American Journal of Industrial Medecine”, 32, 641-646.

- Arndt, V, Rothenbacher, D, Brenner, H, Fraisse, E, Zschenderlein, B, Daniel, U, Schuberth, S, Fliedner, T M (1996) Older workers in the construction industry: results of a routine health examination and a five year follow up. "Occupational and Environmental Medicine", 53, 686-691.
- Aviva (2013) 'Ageing workforce health issues to impact UK business'. Available from <http://www.aviva.co.uk/media-centre/story/16996/ageing-workforce-health-issues-to-impact-uk-busine/> (Accessed: 6th January 2014).
- Badley, E M, and Tennant, A (1992) Changing profile of joint disorders with age: findings from a postal survey of the population of Calderdale, West Yorkshire, United Kingdom. "Annals of the Rheumatic Diseases", 51, 366-371.
- BBC (2011) 'Compulsory retirement age at 65 fully abolished'. Available from <http://www.bbc.co.uk/news/business-15127835> (Accessed: 25th March 2013).
- BBC (2013) 'Retirement 'harmful to health', study says'. Available from <http://www.bbc.co.uk/news/business-22550536> (Accessed: 20th May 2013).
- Beers, A P A, and van der Heijde, G L (1996) Age-Related Changes in the Accommodation Mechanism. "Optometry and Vision Science", 73(4), 235-242.
- Behncke, S (2012) Does Retirement Trigger Ill Health? "Health Economics", 21, 282-300.
- Boschman, J S, van der Molen, H F, Sluiter, J K, and Frings-Dresen, M H W (2011) Occupational Demands and Health Effects for Bricklayers and Construction Supervisors: A Systematic Review. "American Journal of Industrial Medicine", 54, 55-77.
- Brant, L J, and Fozard, J L (1990) Age changes in pure-tone hearing thresholds in a longitudinal study of normal human aging. "The Journal of the Acoustical Society of America", 88(2), 813-820.
- De Jong, A M, and Vink, P (2002) Participatory ergonomics applied in installation work. "Applied Ergonomics", 33, 439-448.
- De Zwart, B C H, Frings-Dresen, M H W, and van Duivenbooden, J C (2002) Test-retest reliability of the Work Ability Index questionnaire. "Occupational Medicine", 52(4), 177-181.
- Frommert, D, Hofäcker, D, Heien, T, and Anderß, H J (2009) Pension systems and the challenge of population ageing: what does the public think? In: Edmondson, R and von Kondratowitz, H (eds.) "Valuing Older People: A Humanist Approach to Ageing". Bristol: The Policy Press.
- Gyi, D, Sang, K, and Haslam, C (2013) Participatory ergonomics: co-developing interventions to reduce the risk of musculoskeletal symptoms in business drivers. "Ergonomics", 56(1), 45-58.
- HSE (2011). Management of risk when planning work: The right priorities. Available from www.hse.gov.uk/construction/lwit/assets/downloads/hierarchy-risk-controls.pdf (Accessed 14th January 2014).
- Holcomb, T F (2010) Transitioning into Retirement as a Stressful Life Event. In Miller, T W (ed.) "Handbook of Stressful Transitions Across the Lifespan". London: Springer.
- Holviala, J, Kraemer, W J, Sillanpää, E, Karppinen, H, Avela, J, Kauhanen, A, Häkkinen, A, and Häkkinen, K (2012) Effects of strength, endurance and combined training on muscle strength, walking speed and dynamic balance in aging men. "European Journal of Applied Physiology", 112, 1135-1347.

- Leaviss, J, Gibb, A, and Bust, P (2008) Understanding the Older Worker in Construction. Available from http://www.sparc.ac.uk/media/downloads/executivesummaries/exec_summary_gibb.pdf (Accessed 10th December 2012).
- Loch, C H, Sting, F H, Bauer, N, and Mauermann, H (2010) How BMW is defusing the demographic time bomb. "Harvard Business Review", 88(3), 99-102.
- Vink, P, Urlings, I J M, and van der Molen, H F (1997) A participatory ergonomics approach to redesign work of scaffolders. "Safety Science", 26(1), 75-85.
- Whysall, Z, Haslam, C, and Haslam, R (2007) Developing the Stage of Change Approach for the Reduction of Work-related Musculoskeletal Disorders. "Journal of Health Psychology", 12(1), 184-197.
- Wilson, J R (1995) Solution ownership in participative work redesign: The case of a crane control room. "International Journal of Industrial Ergonomics", 15, 329-344.

IMPROVING CONSTRUCTION HEALTH AND SAFETY MANAGEMENT IN STRUCTURAL ALTERATION AND BASEMENT CONSTRUCTION TO EXISTING STRUCTURES

David Oloke¹⁸

*¹School of Architecture and the Built Environment, Faculty of Science and Engineering, University of
Wolverhampton, Wulfruna Street, Wolverhampton, WV1 1LY, United Kingdom.*

The United Kingdom (UK) continues to rely on the major alteration and refurbishment works in order to cope with the increasing demand for housing and other spaces. The need is both to accommodate new uses and to upgrade building performance. The scales of the projects vary substantially depending on several factors. At the domestic level, a substantial amount of such works entail permitted extensions, loft conversions, basement constructions and in recent times work involving retrofitting of old stock to make them more energy efficient. At the non-domestic level, alteration and refurbishment projects would normally entail a significant amount of demolition, extension and refurbishment activity. Evidence suggests that this trend is likely to continue into the foreseeable future as the industry continues to address the requirements of sustainable development. However, the incidence of insufficient as-built details' availability to the designers can make the implementation of alteration projects a health and safety management challenge. Previous work using a case-study approach had led to the development of a conceptual information flow framework for such projects. It has also been argued in recent times that technology can play a key role in reducing incident rates further once it positively influences current practices in safety planning. Furthermore, developments in Building Information Modelling (BIM) are proving to be beneficial processes for developing and implementing "prevention through design" or 'design for safety' concepts. This paper presents the methodology being proposed for the emerging framework to include health and safety management improvement in basement construction to existing buildings. In achieving this aim, a review of health and safety issues in alteration and refurbishment of buildings and the existing conceptual model was undertaken. In addition, a case study review of a basement construction project and the proposal for BIM implementation to facilitate construction health and safety management in basement construction was also undertaken. The paper concludes by indicating the status of the work and the recommendation of areas for further research.

Keywords: alteration, basement, BIM, framework, health and safety.

INTRODUCTION

The need to adapt buildings and other structures to accommodate new uses and to upgrade building performance are major reasons for alteration and refurbishment projects (Fernandez, 2011). The scales of the projects vary substantially depending on several factors. A substantial amount of such works entail permitted extensions, loft

¹⁸ d.a.oloke@wlv.ac.uk

conversions, basement constructions and in recent times work involving retrofitting of old stock to make them more energy efficient – especially at the domestic level. At the non-domestic level, alteration and refurbishment projects would normally entail a significant amount of demolition, extension and refurbishment activity – above and beneath ground. In some rare cases, and especially on the older stock, such works involve complete demolition and building up again as a new build project (Oloke, 2012). In either case, however, research continues to show that this trend is likely to continue in the foreseeable future as the industry continues to address the requirements of sustainable development (Thiemann, 2010).

Aim and Objectives of this Paper

This paper seeks to present the status of an on-going research work. The research work has the overall aim of developing a framework for managing health and safety in alteration and refurbishment of buildings. Specifically, however, this paper presents the methodology being proposed for the framework to include health and safety management improvement in basement construction to existing buildings. In achieving this aim, a review of health and safety issues in alteration and refurbishment of buildings and the existing conceptual model; a case study review of a basement construction project and the proposal of a BIM implementation system to facilitate construction health and safety management.

HEALTH AND SAFETY IN ALTERATION AND REFURBISHMENT OF BUILDINGS

The planning of alteration and refurbishment construction projects involves complex activities such as collecting and analysing various information coming from different sources related to the existing structure. Furthermore, all building end-of-lifecycle operations have safety risks due to the many unknown conditions of the building (McAleenan and Oloke, 2010). However, deconstruction is arguably more environmentally friendly than demolition but can be more labour intensive and require more careful planning for critical health and safety issues. According to Balbul (2011), there also continues to be a growing interest in improving landfill management by diverting building materials away from landfills.

In the UK, with property prices so high (particularly in London), it has become commercially attractive for those that can afford it to extend their house downwards by excavating larger basements. These are dubbed ‘iceberg houses’ because they tend to be more spacious below ground than above (Construction Index, 2013). However, according to the UK Health and Safety Executive (HSE), constructing a basement underneath a property is specialised high-risk work that can catastrophically affect the stability of existing buildings. The project architect and engineer must provide detailed plans of the finished basement. The builder must use these plans, together with knowledge of the ground conditions on site, to make sure the construction work is planned and undertaken safely. This includes identifying any temporary works such as trench supports or propping arrangements that are required to ensure the stability of any excavation or existing buildings (HSE, 2012).

However, in a recent inspection, more than a third of domestic basement projects in London failed unannounced safety checks by the Health and Safety Executive (HSE), demonstrating that there had been no improvements since the previous similar inspections in 2011 (Smith, 2013). The main failings reported ranged from poor

planning, failure to appoint competent temporary engineers to designing propping and support and lack of edge protection around open excavations (ibid). The incidence of insufficient as-built details' availability to the designers has also been established to make the implementation of such projects a challenge (Dickson *et al.*, 2009). However, previous research had studied the information collation and flow requirements and assessment for health and safety on alteration and refurbishment projects generally (Oloke, 2011). This was in the light of the use of Building Information Modelling (BIM). The work had examined all aspects of: deconstruction, demolition, alteration and refurbishment and the systematic procedures adopted underpinned the development of the information flow framework (Oloke, 2012).

EXISTING CONCEPTUAL FRAMEWORK

The mandate stipulating that BIM becomes the UK industry standard (for public sector projects) by 2016 has now enabled the UK government set a clear direction for the future of the industry. Several projects have now started to incorporate the use of BIM from the perspective of project information organisation. Such recent UK examples include the £14.5b Cross rail project and the £600m Victoria Station Upgrade (Ballantyne, 2011). The Victoria Station Project particularly represents a very good example of BIM application in alteration and refurbishment projects.

Whilst BIM initially found the quickest application with new builds, the process has evolved substantially into the alteration and refurbishment sector of the industry. Several organisations have therefore provided a wide ranging opportunity for clients to utilise BIM on their alteration/refurbishment project. In the UK, companies like Severn Partnership® (www.severnpartnership.com), continue to take a lead in the provision of services that allow the full scan of floor plans, roof plans, elevations and sections through to a parametric BIM model - an operation well-suited for building renovation, refurbishment and retrofit. Various standard scale floor plans are surveyed in the field with high accuracy reflector less total stations and bespoke building survey software. This can also be useful for picking up floor levels, overhead beams, walls, doors, window openings, heads & cills and reflected ceiling pans of required.

At the basic level, these are issued as AutoCAD DXF, DWG or Microstation DGN in 2D. However, elevations, roof plans & sections can also be captured using the latest laser scanners to capture difficult to access (e.g. roof details) remotely by laser measurement so as to generate detailed plans of roof tops, plant, air conditioning units and walkways. Data on facade details are also picked up in high detail, with the quality assured from having scan data to compose the drawings from. Scanned data have the direct advantages of helping designers to avoid: assumptions, generalisations and errors in interpretation. Hence, costly errors can be reduced whilst at the same time allowing for surveying remotely in real time – avoiding the need for direct access and thereby reducing health and safety risks. Overall, the process enables rapid data gathering where time is very limited (Oloke, 2012). However, more recent technologies have offered the opportunity to scan 3D images using high definition 3D laser scanning to create high accuracy 3D BIM models. In the light of these advancements, a framework is hereby proposed for the collation and utilisation of health and safety information as part of the BIM building process thereby enabling the utilisation of such information for health and safety management during the construction and management phases of the project (ibid).

The risk management register developed from the information flow framework (figure 1) is proposed to form the basis for health and safety management during the lifecycle of the project. Ultimately, a 3D BIM model is to emerge from the integration of the risk register information with the initial building models formed from the 3D laser scan of the existing building and the proposed model. This link is to be achieved via a database/rule-base system as shown in figure 2.

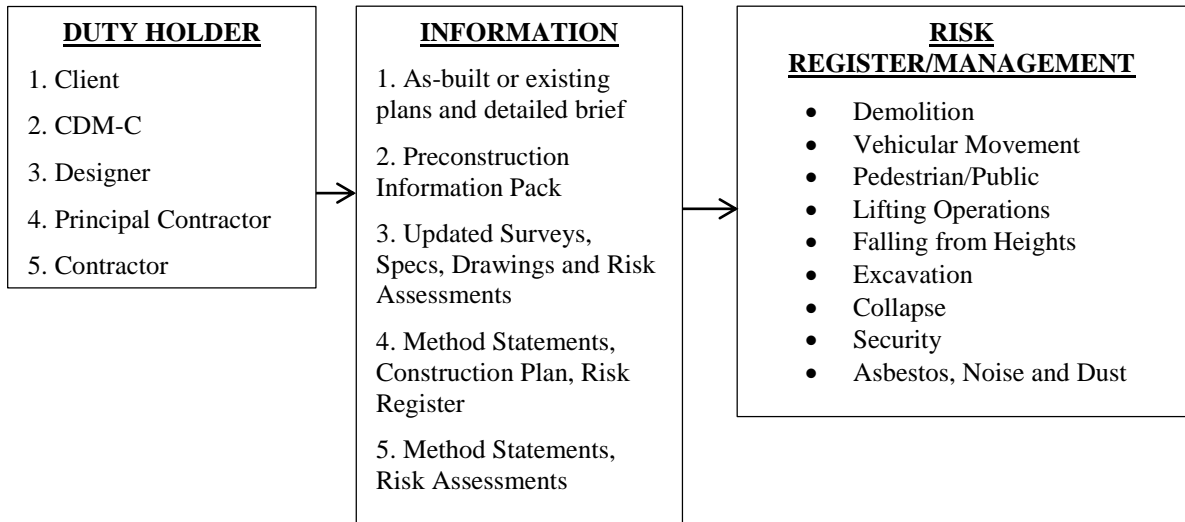

Figure 1: Proposed Information Flow Framework for Alteration/Refurbishment Projects
(Source: Oloke, 2012)

The emergent 3D BIM model is to be an integration of the various elements of the envisaged process. The risk register is designed to provide a user interface that allows the capture of the data linked to a referenced identification (ID) system in respect of the various parts of the existing/proposed structure (Merivirta et al., 2011). The database/ rule-base is the component of the system that will allow data handling, interoperability and rule formulation and application. The main building information is to be provided in the form of the existing and proposed plans and will both form the basis upon which the risk information is ‘attached’ to the emerging model. These will be superimposed on the site plans for the management of transport, access, people movement and all other related environmental risks.

The proposed alteration/refurbishment health and safety BIM framework promotes the much needed integration of the project parties. It should also assist in providing the clear path of the information flow requirements that will aid the development of a robust 3D BIM for alteration/refurbishment projects. Also as shown in figure 2, the outcome is envisaged to evolve as a tool that will aid the health and safety management throughout the ‘post-tender’ lifespan of the project.

Building Information Modelling (BIM) along with Virtual Design and Construction technology (VDC) have been highlighted as being able to provide a powerful new platform for developing and implementing “prevention through design” or ‘design for safety’ concepts. When deployed accordingly, the tools can facilitate both engineering and administrative safety planning and control tasks at the design, construction and maintenance stage of a project.

BIM-enabled virtual safety controls can be used to analyse and forecast the possibility of clashes that can be deemed to be hazardous at the construction, operations/maintenance and decommissioning stages. By simulating the various stages; engineers, architects and contractors can identify key health and safety hazards early enough. This allows for the possibility of being able to design these hazards out (Carpenter, 2010).

A wide range of safety tools to help contractors during the design and construction phase are now available. In addition to BIM, other tools have included: virtual reality (VR), Geographic Information Systems (GIS) and online databases (Fernandez, 2011; Manase et al., 2011) and these have all demonstrated great potential for site health and safety project delivery.

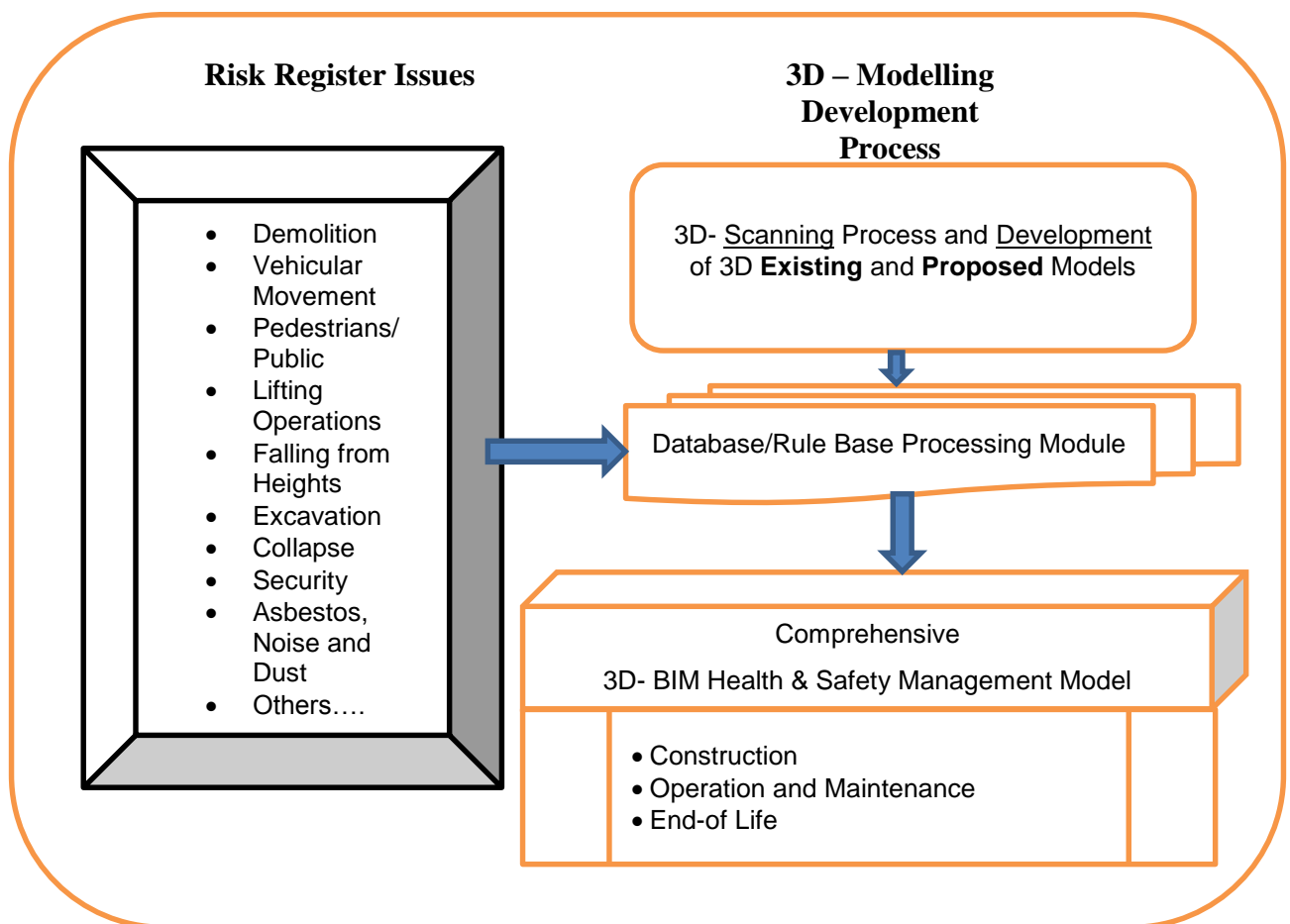

Figure 2: Proposed Alteration/Refurbishment Health and Safety BIM Framework (Source: Oloke 2012)

A CASE STUDY REVIEW OF BASEMENT ALTERATION PROJECT AND PROPOSED BIM MODEL DEVELOPMENT

The case study used for this study was a development which required the alteration and refurbishment of the basement of an existing 5 storey office complex in London, UK (figure 3). The basement which was originally a set of offices was to be converted into a large functional area which was to be used as a larger prayer room and toilet facilities. The work also included a side extension (underground and adjacent to the basement) which was to be used for private conveniences and wash rooms. The building had always belonged to an Embassy who used all the spaces for Consular services all year long. Amongst several other performance specifications, the project was set a time frame of six months and all floors above the basement were to be in full operation throughout the duration of the works. This fairly short duration and operational requirement imposed other health and safety challenges to the project execution.

However, sequel to the commissioning for the proposed works, the actual works were carried out in three stages as follows:

Stage 1 – Initial strip out and full structural appraisal including the commissioning of utility/geotechnical/asbestos and other relevant surveys.

Stage 2 – Engineering Designs and Removal/demolition of partitions and a limited number of beams including the installation of props and other temporary works. This also included excavation of the extension section of the basement.

Stage 3 – Design and Construction works to enable the creation of the proposed new space, fit out and reinstatement - including drainage, civil and services works

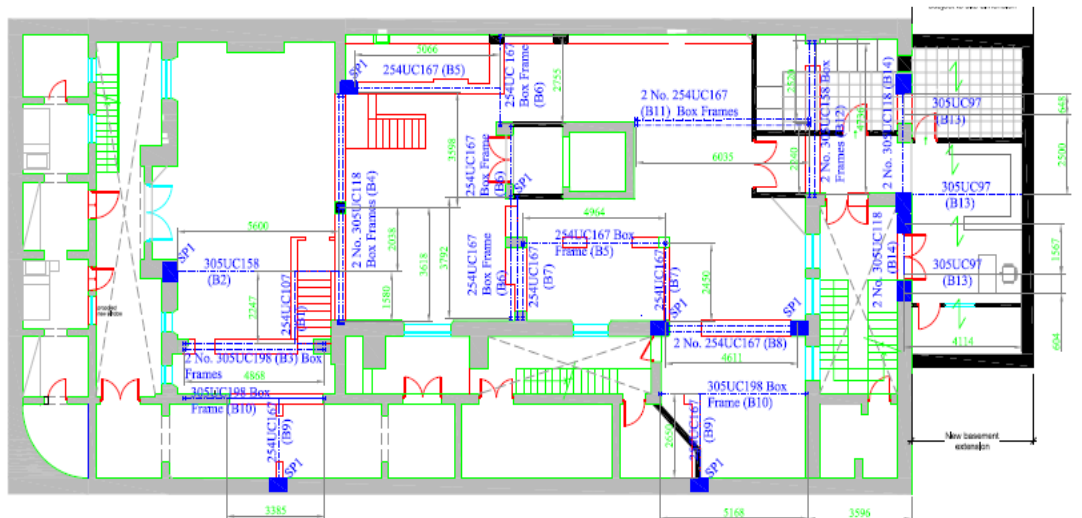

Figure 3: Proposed Plan of the Basement, New Steel Overlay and Side Extension

Table 1 contains a list of the main risk elements assessed and the Duty Holders responsible for highlighting and/or mitigating the risks. Each risk factor was assessed

and was highlighted in the relevant documents – especially the drawings and work schedules. These are in cases where the residual risk could not be eliminated.

The Structural Designer was also the CDM Coordinator on the project and this facilitated the co-ordination of all relevant information and ensured that the appropriate actions to be taken were carried out by the relevant Duty Holders. In the absence of as-built drawings, the Client was tasked with commissioning surveys that led to the generation of existing plans by the designers after which a structural survey was embarked upon to ascertain the location, sizes and materials of the structural members. This procedure was considered most helpful to all the Designers, PC and the Contractors.

In order to further the development of the existing BIM framework presented in figure 2, therefore, the Risk Information Management Schedule developed from this case study guided the schedule design so as to aid the decision-making aspects of the building model.

Table 1: Project Risk Information Management Schedule

S/No.	Risk Factor (Population at Risk)	Party Responsible for Providing Information	Party Responsible for Mitigating
1.	Unauthorised Access to the site (Public)	Client	Contractor
2.	Movement of Vehicles, plant and equipment (Contractors and Public)	Principal Contractor	Principal Contractor
3.	Tripping (Contractors and public)	Principal Contractor	Contractor
4.	Contact with Hazardous Materials (Contractors and public)	Principal Contractor	Contractor/Workers
5.	Asbestos, Noise and Dust (Contractors and public)	Client/Principal Contractor	Workers
6.	Tripping/Falling from height (Contractors)	Principal Contractor	Contractor
7.	Security (Occupiers/Public)	Principal Contractor	Principal Contractor
8.	Collapse (Contractors/Occupiers/Public)	Principal Contractor	Contractor
9.	Lifting Operations – Heavy Steel Members	Designer/Principal Contractor	Contractor
10.	Deep/Excavations	Designer/Principal Contractor	Principal Contractor
11	In Use hazards	Principal Contractor/Client	Principal Contractor
12	End of Life/Future Alterations	Designer/Client	Designers

This implies that the in addition to simulating the structural frame for the proposed alterations, alternative scenarios of loading and failure patterns could be modelled to aid the understanding of the possible hazards – thereby aiding the design of safe systems of work. Movement of materials and components in and through the exit routes will also be easily assessable.

Opportunities and Challenges associated with the Proposed Framework

The BIM environment is a collaborative tool that allows disciplines to work together as federated models. It allows better understanding of construction and 3rd party issues or interfaces and generally helps to improve the management of the project lifecycle. Hence not only can the safety issues be better managed in the design and construction phase of the project but also during the operation and maintenance phases of the facility. More technically, there is the possibility of using Construction Operations Building Information Exchange (COBIE) processes to audit Health and Safety Compliance using data drops. Information such as residual risks and special maintenance information can be tagged into the models. Depending on the Construction Design and Management (CDM) requirements, the model might also be useful for developing the Health and Safety file.

It is however important to note the potential challenges with BIM applications in order to find the most appropriate means of mitigating them. First, there is the need to ensure that the correct processes are used with respect to Health and Safety management and the visibility of information. Secondly, like the various components of the BIM Model, there is a need to ensure that the person who controls Health and Safety Management in the BIM environment is properly identified. Thirdly, the need for composite or federated model for real Health and Safety benefit is important to consider. Finally, it will be important to keep into consideration the Client capability requirement (where there will be a need for the Client to manage the Health and Safety File as a BIM model).

CONCLUSIONS AND RECOMMENDATIONS FOR FUTURE WORK

The planning of projects involves complex activities such as collecting and analysing various information coming from different sources related to the existing structure. Furthermore, all building end-of-lifecycle operations have safety risks due to the many unknown conditions of the building. Early planning of alteration/refurbishment projects is a complicated process which involves the collation of various information from different sources as they relate to the existing structure. Prior previous work had developed a framework aimed at helping UK Health and Safety Duty Holders to collate information that would populate a health and safety risk register. Ultimately, a 3D BIM model is to emerge from the integration of the risk register information with the initial building models formed. This model is thus expected to be an integration of the various elements of the envisaged process.

As part of the thriving alteration and refurbishment construction sector in the UK, there is a rising interest in the construction of basements under existing buildings. However, according to the HSE in the UK, constructing a basement underneath a property has been identified specialised high-risk work that can catastrophically affect the stability of existing buildings. To propose a means of improving Health and Safety management in these respects and in order to further the development of the BIM framework being developed; a Risk Information Management Schedule was developed from a typical basement construction project. This was designed as a case study to aid the decision-making aspects of the building model. This implies that the in addition to simulating the structural frame for the proposed alterations, alternative

scenarios of loading and failure patterns could be modelled to aid the understanding of the possible hazards – thereby aiding the design of safe systems of work. Movement of materials and components in and through the exit routes will also be easily assessable.

Future work will need to incorporate the above findings in the development of the proposed framework model and will also ensure that the correct processes are used with respect to Health and Safety management including the visibility of information in the BIM model. The person who controls Health and Safety Management in the BIM environment is also needed to be properly identified and that for real Health and Safety benefit, composite or federated model is importantly considered. On a final note, where the Client will manage the Health and Safety File as a BIM model the Client capability requirement will need to be considered in the development of the model.

REFERENCES

- Ballantyne, B., (2011) Driving BIM forward. *New Civil Engineer*. 15.12.11
- Balbul, T. (2011) An Analytical of Construction Workers Safety during Building Decommissioning and Deconstruction. *Proceedings of the CIBW099 Safety in Construction Conference, Washington DC, August.*
- Carpenter, C. (2010). Risk Management with ERIC. *The Structural Engineer* 88 (7), 20-21.
- Construction Index (2013), One in Three Basement Extensions failing to Meet Safety Standards. *Construction Index, Construction News, 5th April 2013*
- Dickson, M., Solomon, J., Bruyere, D (2009). Let the Building Speak to You. *The Structural Engineer*. 88 (11), 21-27.
- Fernandez, S. (2011). Regeneration of Newton Arkwright Buildings in Nottingham Trent University. *The Structural Engineer* 89 (3), 21-25.
- Health and Safety Executive – HSE (2012), *Domestic Basement Construction Projects: What you need to Know as a Busy Builder*. HSE, London, CIS66, March
- Manase, D., Heesom, D., Oloke, D., Proverbs, D., Young, C., Luckhurst, D. (2011) A GIS Analytical Approach for Exploiting Health and Safety Information. *International Journal of IT in Construction, ITCon* (16), 335-356.
- McAleenan, C. and Oloke, D. (Eds). (2010). *ICE Manual of Health and Safety in Construction*, ICE Publishing, London
- Merivirta, M; Mäkelä, T; Kiviniemi, M; Kähkönen, K; Sulankivi, K, Koppinen, T (2011) Exploitation of BIM Based Information Displays for Construction Site Safety Communication. *Proceedings of the CIBW099 Safety in Construction Conference, Washington DC, August.*
- Oloke, D. (2011) Preventing Accidents and Major Injuries on Major Alteration/Refurbishment Works: A framework for Relevant and Effective Information Co-ordination. *Proceedings of the CIBW099 Safety in Construction Conference, Washington DC, August.*
- Oloke, D.(2012), *Health and Safety Management in Alteration and Refurbishment Projects using Building Information Modelling: Proceedings of the CIBW099 Safety in Construction Conference, Singapore, September.*

Smith, C (2013) Inspections Demonstrate no Safety Improvements in Domestic Basement Markets. *New Civil Engineer Magazine*. December 18th.

Theimann, R. (2010). Refurbishment Challenges. *The Structural Engineer* 88 (11), 19-21.

EVALUATING THE POTENTIAL AND CHALLENGES OF UTILISING COMPUTATIONAL SIMULATION TO DESIGN SAFETY MANAGEMENT AND CULTURE INTERVENTIONS

Yang Miang Goh¹⁹ and Palak Gupta¹

¹ *Yang Miang Goh 1 Safety and Resilience Research Unit (SaRRU), Centre for Project Management and Construction Law, Department of Building, National University of Singapore, 4 Architecture Drive, Singapore 117566*

¹ *Palak Gupta 1 Safety and Resilience Research Unit (SaRRU), Centre for Project Management and Construction Law, Department of Building, National University of Singapore, 4 Architecture Drive, Singapore 117566*

The safety management and culture (SMC) literature is inundated with psychometric tools to measure safety climate, which is frequently assumed to represent the safety culture of an organisation. Even though the usefulness of these questionnaires had been challenged, their popularity is overwhelming. On the other hand, some authors claimed benefits in using computational simulation to facilitate understanding and improving SMC, but simulation is not as common in the SMC literature. The aim of this paper is to review the current literature on computational simulation of SMC and evaluate their potential benefits and challenges in designing safety culture interventions for workplaces. The key features and limitations of existing models were systematically evaluated to facilitate discussion. The suitability of different simulation techniques, like system dynamics (SD), agent-based modelling (ABM) and discrete event simulation (DES), was also discussed. It was found that simulation can complement safety climate surveys by providing a planning tool for SMC interventions (e.g. training and allocation of incentives and penalties). In addition, a simulation can facilitate a systematic approach in considering possible scenarios and assess the impact of parameter uncertainties using Monte Carlo simulation methods. However, some of the challenges in developing SMC simulation models include the lack of data to assess the credibility of the models, difficulties in explaining the models to practitioners and the time taken to develop models of adequate detail. It was proposed that a conceptual structure for SMC simulation model should consist of: (1) human agents that perform safety-related actions based on risk perception, work pressure, competency, beliefs and interactions with other agents and systems; and (2) work processes including production workflow, safety processes and the resources necessary for the processes. The conceptual structure can be implemented using a hybrid of simulation techniques where ABM is used to model the human agents, SD can be used to model the cognitive processes of agents and DES can be used to model the safety management and work processes.

Keywords: agent-based, behaviour, computational models, safety culture, safety management.

¹⁹ bdggym@nus.edu.sg

INTRODUCTION

Safety culture is an intensely researched area in the safety management literature. It is generally agreed that a safety management system will not meet its intent of continually improving safety performance without a strong safety culture (Cooper, 2000) and learning culture. However, organizational learning is frequently impeded by the inability to decipher complexity (Goh et al., 2010). According to Senge (2006), systems thinking, which is a discipline for seeing wholes, understanding interrelationships, patterns and complexity, is necessary for organizational learning. Sterman (2000) and Senge (2006) envisaged that computer simulation models will enable organizations to practice systems thinking by experimenting with different scenarios of a complex issue, understand possible consequences of strategies, surface mental models and encourage team learning.

Accordingly, managers trying to improve safety management and culture (SMC) can potentially benefit from the use of simulation models. Even though there are existing simulation models of safety management and culture (e.g. Cooke and Rohleder, 2006; Sharpanskykh and Stroeve, 2011), these simulation models are not common. Thus, the aim of this paper is to conduct an in-depth evaluation of six existing papers on SMC simulation and use them to discuss the potential benefits and challenges of using simulation models to design SMC interventions, e.g. training, incentives and penalties and communication channels. In addition, recommendations for the development of simulation models to facilitate design of SMC interventions will be provided.

SAFETY MANAGEMENT, SAFETY CULTURE AND SAFETY CLIMATE

To facilitate the subsequent discussion, it is imperative to define the key concepts here. Safety management is essentially the activities related to the creation, implementation and improvement of organizational policies, processes and structures to manage the safety and health risk of an organization. Safety culture is a pattern of shared basic assumptions that the organization has learnt as it solved its safety-related problems of external adaptation and internal integration, that has worked well enough to be considered valid and, therefore, to be taught to new members as the correct way to perceive, think and feel in relation to safety-related problems (adapted from Schein, 1992). To put it simply, safety culture can be defined as those aspects of organizational culture that may have an effect on safety (Stroeve, 2011). In contrast, safety climate is defined as ‘individual perceptions of the policies, procedures and practices relating to safety in the workplace’ (Flin, 2000). The distinction between culture and climate remains a source of some debate and confusion in the literature (Guldenmund, 2000) but, safety climate is generally considered as a manifestation of safety culture based on the aggregated perceptions of employees of the significance of safety in their jobsite. Many researchers proclaim the usefulness of using safety climate as an indicator of safety culture and safety performance (e.g. Zohar, 2010).

COMPUTATIONAL SIMULATION MODELLING

Besides theoretical analysis and empirical analysis, simulation has now been recognized as the third way of doing science (Axelrod, 1997). Simulation modeling is also known as formal modeling because it translates qualitative natural language propositions and assumptions into specific mathematical equations or rules that reduces ambiguity. Based on Axelrod (1997) simulation modeling can be used for the

following management research purposes. Firstly, simulation models can be used to predict system behaviours so as to develop hypotheses of organizational behaviour or evaluate different ways to organize work flow. Secondly, a simulation model can be used to explain and demonstrate the existence of theoretical behaviour and relationship between variables. Thirdly, simulation can facilitate the discovery of unexpected behaviours and consequences arising from interactions between agents and variables in the model. Fourthly, simulation can facilitate design of empirical data collection strategies that are more efficient and focused. This study is particularly interested in the use of simulation to design ways of organizing work so as to achieve better safety management and culture.

There are three main types of simulation techniques in management and social research: (1) system dynamics (SD), (2) agent-based modeling (ABM), and (3) discrete event simulation (DES) (Carley, 2009; Pidd, 2004). SD is grounded in systems of differential equations and a SD model is made up of stocks, flows, and auxiliary variables that are inter-connected (Sterman, 2000). The core of a SD model is the stocks, which vary at each time step based on the difference between the flow rates in and out of the stock. A mathematical equation or an if-then rule is embedded within each variable or flow rate in the model and the values are analyzed using numerical methods. SD simulation typically uses fixed time steps and continuous and aggregated variables. ABS is focused on the design of individual entities or agents and the social actions that they perform. In ABS, agents can be heterogeneous and they are allowed to interact with each other and its environment in an autonomous fashion. In ABS simulation, time can be continuous or handled in a discrete fashion. Unlike SD and ABS, DES models advance from one event to another, rather than continuously. Each event corresponds to some significant change in the model and a queue of events is maintained in the model. Even though DES can be modeled in different ways, most DES models take a process view of the world, i.e. the core of the model is a sequence of steps or a flow chart, e.g. in a production line. The entities included in a DES model are usually the inputs and outputs of a process, e.g. the material, equipment and people necessary for a process step to be successfully implemented, and the product or intermediate product of the process. The entities are usually not able to interact with each other and they do not display adaptive behaviours as in ABS. It is noted that ABS and SD are usually recognized as complex system models, but not DES (Carley, 2009).

RESEARCH APPROACH

The study is essentially a case study research that allows detailed information to be drawn from selected cases so as to answer relevant research questions. The following research questions were devised to guide the study: (1) What are the demonstrated benefits of existing safety management and culture (SMC) simulation in designing SMC interventions? (2) What are the limitations and challenges in using simulation models to design SMC interventions? (3) How should a SMC simulation model be structured so as to facilitate design of SMC interventions? Papers for the detailed review were selected based on the following criteria: (1) paper is published in a peer-reviewed journal; (2) paper is focused on safety management or safety culture (or climate) issues; (3) a computational simulation model was developed as part of the paper; and (4) paper is published from year 2000 onwards. However, the review does not aim to be comprehensive and it is acknowledged that there are relevant papers that were not included in this study. Instead, this study aims to evaluate the selected papers

in detail to understand how different SMC variables were modeled. To assist in the evaluation, five safety climate themes identified by Flin et al. (2000), namely management (including supervisors), safety management system, risk, work pressure and competence, were used to organize the review. Subsequently, the authors provided their assessment of the potential and challenges in using the existing simulation models to improve SMC. Recommendations for the development of SMC simulation models were then provided based on the review and assessment.

OVERVIEW OF CASES

Based on the criteria discussed above, six SMC simulation papers were selected for detailed evaluation and comparison. Most of the models were developed using SD. However, one of the papers used ABM approach. In addition, even though Feola et al. (2012) adopted SD, the model was agent-oriented and arrays were used to identify individual agents within the SD approach. Papers 1 to 4 were focused on theory development or explanation of accident causation. In contrast, papers 5 and 6 were focused on design of SMC interventions and evaluation methods. Each of the papers will be discussed briefly below.

Paper 1: Rudolph and Repenning (2002)

Rudolph and Repenning (2002) studied the relationship between non-novel interruptions and system performance using SD. The model was focused on how interruption arrival rate and accumulation of unresolved interruptions cause stress leading to degeneration of system performance and finally system collapse. A non-novel interruption is essentially a deviation from normal operation (e.g. a breakdown) or new demands that reduces cognitive capacities of employees. At the core of the model, the system stress at time (t) was related to resolution rate of arrival of interruptions as follows:

$$\text{Stress } (t) = \frac{\text{Desired resolution rate } (t)}{\text{Normal resolution rate}} \quad (1)$$

Where

$$\text{Desired resolution rate } (t) = \frac{\text{Interruptions pending } (t)}{\text{Desired resolution time}} \quad (2)$$

Resolution rate refers to the speed at which interruptions were resolved and interruptions pending (t) refers to the total number of unresolved interruptions. As interruptions accumulate, the desired resolution rate is increased, but the increase in desired resolution rate, as compared to normal resolution rate, causes stress. One of the core theoretical foundations of the paper was the Yerkes-Dodson curve, which depicts an inverted U shape relationship between stress and performance. Initially, stress improves interruption resolution rate, but beyond certain threshold, the negative effect of stress dominates causing the interruption resolution rate to decrease and the system becomes susceptible to disaster.

Paper 2: Cooke (2003)

Cooke (2003) examined the conditions that led to the fatal explosion at the Westray mine in Canada using a SD model. The model was compartmentalized into four subsystems: (a) Production, (b) Human Resources, (c) Safety, and (d) Mine Capacity. The model covered numerous SMC variables including management commitment to safety, workers' personal commitment to safety, production pressure and training and

competence of miners. Many relationships were determined arbitrarily, for example, the paper assumed that risky behaviors of workers were inversely proportional to the personal commitment to safety. The personal commitment to safety is dependent on numerous factors such as management commitment and past experience. Management commitment is then dependent on production pressure and average incident rate. Average incident rate is determined based on risky behavior, industry incident rate and unsafe conditions. Equations (3) to (5) are provided as an illustration of the equations used in the model.

$$\text{Incident Rate} = \frac{(\text{Unsafe Conditions} + \text{Risky Behavior}) * \text{Industry Incident Rate}}{2} \quad (3)$$

$$\text{Unsafe Conditions} = \frac{1}{\text{Relative Management Commitment to Safety}} \quad (4)$$

$$\text{Pressure to Change Mgmt Commitment to Safety} = A * B * C \quad (5)$$

where $A = \text{Management Commitment to Safety}$; $B = \text{Effect of Relative Incident Rate on Mgmt Commitment to Safety}$; $C = \text{Effect of Mgmt Drive to Produce on Mgmt Commitment to Safety}$

Cooke (2003) devised four scenarios to determine the impact of changes in the different parameter values. The scenarios were: (1) no incidents at the mine, (2) mine having normal industry incident rate, (3) high incident rate and high loss of mine capacity for each incident, and (4) maintaining a safety first approach. The simulation results for the third scenario showed that due to the reduction in mine capacity due to incidents, production pressure increases and management places production over safety resulting in even more incidents. The last scenario showed the positive effects of a consistent “safety first” policy, which significantly weakened the linkage between *Management Drive to Produce* and its effect on *Management Commitment to Safety*. This indicates that commitment to safety cannot be affected by production pressure. A reduction in management commitment to safety can trigger a vicious cycle of frequent incidents, increase in production losses and pressure, and further decrease in management commitment to safety.

Paper 3: Cooke (2006)

Cooke and Rohleder (2006) proposed a theoretical SD simulation model of incident learning. The simulation model contains several subsystems, but the main subsystem of interest is the incident learning system. Within the incident learning system, the key variables are *Lessons Learned*, *Management Commitment to Safety*, and *Unsafe Conditions*. The study postulated that lessons learnt from incidents are forgotten overtime and there is a need to ensure that organisations continue to learn from incidents so as to sustain management commitment to safety. The rate of incident learning is modelled as below.

$$\text{Incident learning rate} (t_1) = \frac{\text{Desired learning rate}(t_1) - \text{Incident learning rate} (t_0)}{\text{Learning Migration Time}} \quad (6)$$

where $\text{Desired learning rate}(t_1) = \text{Organizational Ability to Learn} * \text{Corrective Actions}$ (7)

Equation 5 is an example of how the model used delay functions to model changes in “soft” variables such as commitment and lessons learnt. The basic assumption is that such “soft” variables take time to adjust despite changes in the desired level. As a whole, the paper showed the importance of reporting and learning from incidents. In

addition, the model highlighted the positive impact of incident learning on productivity.

Paper 4: Salge & Milling (2006)

Salge and Milling (2006) analysed the causes of the Chernobyl accident using SD. The study developed two models: (i) the reactor design, and (ii) human failures in on-line operations. The first model demonstrated how wrong design of equipment can lead to a runaway reaction. While the second model, which is more relevant to this paper, illustrated how failure to adhere to safety rules can lead to disasters. The second model showed that operators may by-pass safety procedures to get relief from production pressure as a quick fix and each time a by-pass was conducted without incident the tendency to commit a by-pass in the future would increase. However, operators did not realise that they had been lucky in having a successful by-pass. The study postulated that likelihood of accidents is dependent on the ratio between number of by-passed tasks and number of regularly accomplished tasks. Instead of using an equation to determine likelihood of accident, a graph (see Figure 7) was used to define the relationship. As can be observed from Figure 7, Y (likelihood of accidents) increases linearly when X (ratio of number of by-passed tasks to number of regularly accomplished tasks) exceeds 0.9.

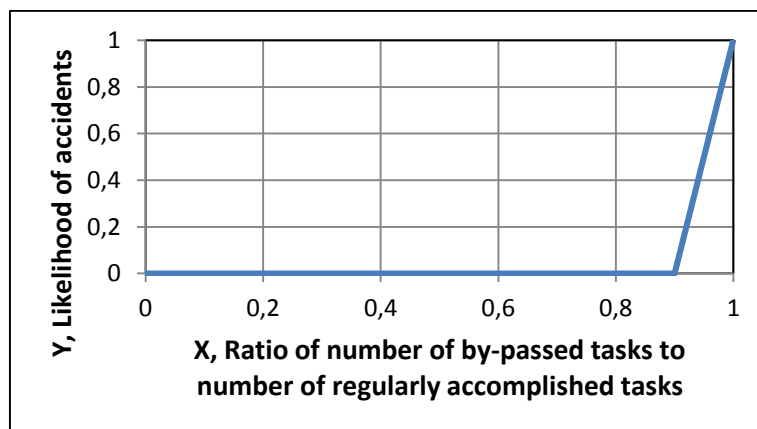

Figure 7 Lookup for Likelihood of Accidents

The approach of using lookup graphs to formulate relationship between variables, particularly “soft” management variables, is a common technique in SD. The approach is usually used when empirical data is not available and there are experts who can express the general trends of causal relationships between variables.

Paper 5: Stroeve, Sharpanskykh & Kirwan (2011)

Sharpanskykh and Stroeve (2011) presented an ABM approach for integration and systematic evaluation of immaterial (values and beliefs) and material (structures and processes) characteristics of safety management. The paper used a simulation approach to identify the safety culture aspects relevant to reporting and investigation of safety occurrences, e.g. runway incursions and separation minima infringements, among a group of air traffic controllers. The simulation used three perspectives in the model: individual, team, and intra-organizational. Different safety culture issues were identified for each perspective. For instance, individuals might not trust that reporting confidentiality will be enforced, and within a team, willingness to cooperate may decrease after an incident and whether the importance of safety-related goals was threatened by performance-related goals.

Sharpanskykh and Stroeve (2011) created agents that perceive information by observation or communication and generates output in the form of communication or actions. The internal states of an agent include information attitudes (e.g. belief and knowledge), pro-attitudes (e.g. desire, intention, obligation and commitment) and characteristics (e.g. needs, personality, and skills) and external states include dynamic relations between agents and the environment. The decision making of agents in the model was based on expectancy theory by Vroom (1964), which states that choice of actions are dependent on the agent's evaluation of the expected direct outcomes of an action (expectancy), second level outcomes of the direct outcomes (instrumentality) and strength of the desire for the overall outcome (valence) of the action. Based on Vroom's model, the "force" or motivation behind an action is formulated as

$$F_i = \sum_{j=1}^n E_{i,j} \cdot \sum_{k=1}^m V_k \times I_{i,j,k} \quad (8)$$

where $E_{i,j}$ is the strength of the expectancy of action A_i will lead to outcome j ; V_k is the valence of the second level outcome; $I_{i,j,k}$ is the perceived likelihood (instrumentality) of outcome j for the realisation of second level outcome k following first level outcome j and action i .

The study used a safety climate survey to validate the simulation model and to determine values of variables in the simulation model. Stochastic variables were used in the simulation and a sensitivity analysis using Monte Carlo filtering was performed to identify influential safety climate indicators. As a result, eight safety climate indicators were identified and they include perceived sufficiency of number of controllers and safety investigators, perceived level of managerial skills, and priority of safety-related goals in the role description.

Paper 6: Feola, Gallati & Binder (2012)

Feola et al. (2012) proposed an agent-oriented SD model to investigate farmers' underuse of personal protective equipment (PPE) while spraying pesticides. Agents' behaviours were determined based on intention, habit (frequency of past behaviour), physiological arousal (physiological state of the individual) and external contextual factors (e.g. time to forget acute impact of adverse health effects). Intention was dependent on expectations (beliefs about the probability and values of outcomes), culture (norms, roles and values) and affect (feelings associated with the act). The study collected empirical data to profile different types of farmers and several regression models were used to estimate the probability of use of different PPE (see Equation (9) for an example). The key dynamics that the model was concerned with were: conformity with social norm, and reaction to adverse health effects. Social norm was an aggregate of individual agent behaviours and individuals' perception of the social norm will affect the choice of individual behaviour. The study also included interviewing of experts to gain confidence about the credibility of the model.

$$y = \frac{1}{1 + e^{-(\beta_0 + x_1 \cdot \beta_1 + x_2 \cdot \beta_2 + x_3 \cdot \beta_3 + x_4 \cdot \beta_4 - x_5 \cdot \beta_5 - x_6 \cdot \beta_6 - x_7 \cdot \beta_7 + x_8 \cdot \beta_8)}} \quad (9)$$

where y = probability of glove use; x_1 = behaviour appropriacy; x_2 = labels; x_3 = sensitivity; x_4 = interference; x_5 = partner; x_6 = workload; x_7 = age; β_0 to β_8 are regression parameters.

In addition, the study modelled a range of possible intervention policies, e.g. improve safety labels, targeting health issues in household so as to increase pressure exerted by

farmers' partners, and reduction in PPE cost. The paper used the simulation model as a platform for policy analysis.

COMPARISON OF SIMULATION MODELS

Table 8 is structured based on the five most common types of safety climate dimensions, or 'themes', as described by Flin et al. (2000). The key variables in the simulation models of the six papers evaluated in this study were categorized into the five themes. In addition, the last column highlighted relevant variables not captured in the five themes.

Table 8 Comparison of safety climate variables in simulation models

Safety Climate Themes Based on Flin et al. (2000)								
No	First Author	Year	Mgt/ Sup	Safety system	Risk Perception & Behaviour	Work pressure	Competence	Others
1	Rudolph	2002				Stress		Performance; interruptions
2	Cooke	2003	Management commitment		Personal commitment ; risky behaviour; learning from incident (memory of individual); unsafe conditions	Management drive to produce; Production pressure	Experience of miners	mine capacity; human resources
3	Cooke	2006	Management commitment	Incident learning system; Willingness to report and investigate incident; Corrective actions	Personal commitment , risky behaviour, learning from incident (memory); unsafe conditions	Productivity pressure	Experience of investigators	
4	Salge	2006			Personal commitment ; by-passing experience	Perceived relief; perceived pressure		Design of equipment
5	Sharpanskyh	2011	Management & supervisor commitment ; priority of safety-related goals	Occurrence reporting & investigation ; sufficiency of safety resources; developed & implemented SMS; quality of reports	Average commitment to safety; memory (states & individual beliefs)		Safety knowledge and managerial skills	Informal discussion; meetings; empowerment of frontline staff
6	Feola	2012			Social norm; memory of use; experienced health effects	Workload		Occupational health risk; probability of PPE use

Cooke and Rohleder (2006) was the most comprehensive and all the safety climate themes were covered in the simulation model. Cooke (2003) and Sharpanskykh and Stroeve (2011) were also relatively comprehensive, with each missing only one theme. In contrast, Rudolph and Reppenning (2002) and Salge and Milling (2006) were focused on specific safety culture related issues. It is noted that management and safety system were not as relevant to Feola et al. (2012) because the paper was focusing on small-scale farming, where farmers do not usually have safety management systems. Risk perception and behavior was the most commonly modeled theme in the six papers evaluated. Cooke (2003), Cooke and Rohleder (2006) and Salge and Milling (2006) assumed homogeneity in the risk perception and behavior of workers. In contrast, Sharpanskykh and Stroeve (2011) and Feola et al. (2012) took significant effort to differentiate between types of workers. Work pressure was studied in all papers except Sharpanskykh and Stroeve (2011), while management, safety system and competence were studied in half the papers.

DISCUSSION AND RECOMMENDATIONS

What are the benefits of SMC simulation models?

With reference to Table 8, paper 6 demonstrated the use of a simulation model to analyse and assess different interventions to improve safety behaviour of farmers. The simulation model provided a platform for exploring different policies and strategies. The effects of different combinations of policies, as suggested by experts, were studied using the simulation model. An operator health risk (OHR) indicator was also used to compare the effectiveness of different strategies. Similarly papers 2 and 3 also considered impact of different actions or interventions on the model output. The papers showed that a simulation model can serve as a “sandbox” to help managers and policy makers think through the possible impact and side effects of different strategies. The ability to consider complex safety management scenarios prior to implementation of interventions can potentially save precious resources wasted on ineffective programmes that can also cause negative side effects. The process of formally representing the work, workers and managers can potentially help managers to understand their workplace better.

Paper 5 utilised Monte Carlo simulation to assess the impact of random variables on the safety climate indicators. In addition, a sensitivity analysis based on Monte Carlo filtering was conducted to determine the importance of different variable on safety climate, as measured by the safety climate index described in the paper. Furthermore, the results of the simulation model were compared with an actual safety climate survey and workshop. The results of the Monte Carlo simulations provided useful guidance on the design of safety management and culture interventions, where managers can design programmes to improve the critical variables identified by the simulation. In contrast to papers 2, 3 and 4, where pre-determined scenarios were assessed in a deterministic manner, Monte Carlo simulation allows the modellers to consider the impact of randomness and uncertainty of variables. Instead of a point estimate of safety climate, the simulation model provides a distribution of the safety climate index, which is more informative.

What are the limitations and challenges?

Despite the benefits discussed earlier, there are many limitations and challenges in developing SMC simulation models. One of the challenges is the difficulty in

representing human decision making using representations such as Equations 1 to 9 and Figure 7. These representations are frequently based on relevant theories or expert opinions, but most are not supported by strong empirical data. In addition, with the exception of paper 5, the output of the simulation models reviewed were not validated with empirical data. Even though paper 6 used regression equations in its model, the output of the model was not validated. In view of the variability and complexity of human behaviour and decision making, a rigorously validated SMC simulation model may not be realistic. It should be noted that simulation model of complex managerial and policy issues are fundamentally a platform for planning and discussion. In contrast to a trial and error approach, a simulation model provides managers another tool to assist in their planning and design of SMC interventions. Based on the approach used in paper 5, the development process of a simulation model should be coupled with empirical tools such as audits and safety climate surveys to build *credibility* (in contrast to *validity*) of the simulation model. The simulation model should be periodically adjusted based on the empirical inputs to ensure that its credibility continues to be adequate.

Another challenge is that simulation models get complicated easily and it may be difficult for practitioners and managers to understand the model. The model can be perceived as a blackbox and such perception can lead to resistance in using the model. To overcome this limitation, modellers will need to involve practitioners during development as frequently as possible. In addition, training and user-friendly design of simulation models will help to gain acceptance. Another related challenge is the development time. Simulation models of adequate detail need significant effort in data collection and programming. Since it is important to involve the users in the development process, organisations may not be willing to invest the time to participate in the development process. It is envisaged that organisations will probably be more motivated to participate in the development process if the model helps to improve production performance and a more direct benefit can be gained from the investment in the development process.

How should a SMC simulation model be structured?

It is recommended that a SMC simulation model should consist of two main modules (see Figure 8). Firstly, the SMC model should contain agents with different roles, but each class of agent has the ability to decide on its behaviour based on risk perception, work pressure, competence, commitment and beliefs and interactions with other agents and processes. Secondly, safety and production processes, including the necessary equipment and resources, should be modelled.

<p style="text-align: center;">Human Agents (worker / supervisor / manager)</p> <ul style="list-style-type: none"> - Decision making and action - Risk perception - Work pressure - Competence - Commitment and beliefs - Interactions and feedback 	<p style="text-align: center;">Processes (workflows)</p> <ul style="list-style-type: none"> - Safety processes - Production processes - Equipment and resources necessary for safety and production processes
--	---

Figure 8 Proposed structure of a SMC simulation model

The recommended structure should be implemented using a hybrid simulation approach (Swinerd and McNaught, 2012), where ABM and DES are used to model agents and processes respectively. ABM makes it more natural for the concept of

bounded rationality to be modelled, i.e. agents have limited cognitive capacity to optimize their decisions in complex and uncertain situations. The cognitive processes of each agent, which is usually represented by continuous variables, can be modelled using a SD approach (e.g. using equation (1)). In the context of SMC, agents will have to consider the demands of the production system and safety system. The aggregated behaviours, values and beliefs of agents provide indicators of safety culture of the workplace. Another key feature of ABM is that network details can be taken into consideration more readily and the agent's network characteristics can determine social influences and related dynamics. ABM is a bottom-up approach, where details about the system are less significant than details of the agent. Due to its bottom-up approach, ABM can be used to study emergence of system behaviour from different formulation of workplace policies, interventions and agent characteristics. This proposed structure is advantageous because it uses the most suitable modelling approach for different parts of a model.

However, the proposed structure faces two foreseeable challenges, namely required computational power and modeling competency. The required computational power is dependent on the number of agents that need to be modeled, which should not be a major problem with the relatively low cost of computational power in recent time. The second issue is, the need to learn three modeling techniques, but this challenge can be overcome with the availability of hybrid simulation software and recruiting a team of modelers with experience in the different simulation approaches. Despite the technical challenges, the crux of successful simulation modeling still lies in the modeling process and selection of suitable representation of real world phenomenon.

CONCLUSIONS

It is proposed that simulation models can add on to the range of tools that managers can use to design safety management and culture (SMC) interventions. A simulation model can facilitate a systematic approach in considering possible safety management scenarios and assess the impact of parameter uncertainties using Monte Carlo simulation methods. The proposed hybrid simulation (agent-based, discrete event and system dynamics) approach allows detailed consideration of individual agent's behaviours and decision making processes, and at the same time allow work processes to be modelled in sufficient detail. A simulation model should be based on empirical data such as safety climate surveys and safety management system audits to increase its credibility.

REFERENCES

- Axelrod, R., 1997. The complexity of cooperation: Agent-based models of competition and collaboration. Princeton University Press, Princeton, NJ.
- Carley, K.M., 2009. Computational modeling for reasoning about the social behavior of humans. *Computational and Mathematical Organization Theory* 15, 47-59.
- Cooke, D.L., 2003. A system dynamics analysis of the Westray mine disaster. *System Dynamics Review* 19, 139-166.
- Cooke, D.L., Rohleder, T.R., 2006. Learning from incidents: from normal accidents to high reliability. *System Dynamics Review* 22, 213-239.
- Cooper, M.D., 2000. Towards a model of safety culture. *Safety Science* 36, 111-136.

- Feola, G., Gallati, J.A., Binder, C.R., 2012. Exploring behavioural change through an agent-oriented system dynamics model: the use of personal protective equipment among pesticide applicators in Colombia. *System Dynamics Review* 28, 69-93.
- Flin, R., Mearns, K., O'Connor, P., Bryden, R., 2000. Measuring safety climate: identifying the common features. *Safety Science* 34, 177-192.
- Goh, Y.M., Brown, H., Spickett, J., 2010. Applying systems thinking concepts in the analysis of major incidents and safety culture. *Safety Science* 48, 302-309.
- Guldenmund, F.W., 2007. The use of questionnaires in safety culture research - an evaluation. *Safety Science* 45, 723-743.
- Pidd, M., 2004. *Computer simulation in management science*. John Wiley & Sons, Chichester.
- Rudolph, J.W., Reppenning, N.P., 2002. Disaster dynamics: Understanding the role of quantity in organizational collapse. *Administrative Science Quarterly* 47, 1-30.
- Salge, M., Milling, P.M., 2006. Who is to blame, the operator or the designer? Two stages of human failure in the Chernobyl accident. *System Dynamics Review* 22, 89-112.
- Schein, E.H., 1992. *Organizational Culture and Leadership*, 2 ed. Jossey-Bass, San Francisco.
- Senge, P., 2006. *The fifth discipline - The art & practice of the learning organisation*, 2nd ed. Random House Australia, New South Wales.
- Sharpanskykh, A., Stroeve, S.H., 2011. An agent-based approach for structured modeling, analysis and improvement of safety culture. *Computational and Mathematical Organization Theory* 17, 77-117.
- Sterman, J.D., 2000. *Business dynamics: systems thinking and modeling for a complex world*. Irwin/ Mac-Graw Hill, Boston.
- Swinerd, C., McNaught, K.R., 2012. Design classes for hybrid simulations involving agent-based and system dynamics models. *Simulation Modelling Practice and Theory* 25, 118-133.
- Vroom, V.H., 1964. *Work and motivation*.
- Zohar, D. (2010). Thirty years of safety climate research: Reflections and future directions. *Accident Analysis and Prevention*, 42(5), 1517-1522. doi: 10.1016/j.aap.2009.12.019

DESIGN RISK MANAGEMENT PRACTICES AND ASSESSMENT TOOLS FOR SAFETY IN CONSTRUCTION: OPPORTUNITIES FOR BIM

Kihong Ku²⁰

¹ *Philadelphia University, Architecture Program, 4201 Henry Ave, Philadelphia, PA 19144*

The imperative to improve workers safety and health is gaining momentum in the construction industry in a number of countries (e.g., UK, Australia, US). Prevention through Design (PtD) or comparable concepts (i.e., Design for Safety) are a core strategy considered critical in improving overall safety performance. PtD proponents argue that architects and engineers can have an impact on safety considerations during design. However, there is lack of knowledge on what tools designers utilize for safety design. Design risk management strategies and assessment tools for safety are studied and opportunities for BIM safety design tools are identified. To gather broad industry perspectives, this investigation adopted the survey research method that involved professionals from the US, UK, Australia and other countries. The survey was developed based on literature on hazard identification/risk assessment tools, and expert interview discussions. The survey collected data on general design protocol and BIM infrastructure, familiarity with PtD, references of safety regulations and standards, and PtD tools and processes. The findings illustrate most commonly used tools and effective strategies, type of design tools used for construction, maintenance/operations, comparisons of disciplinary perspectives and comparisons of countries. The survey illustrates common usage of BIM for safety considerations and reveals which types of PtD tools provide potential for integration with BIM, and shortcomings of BIM for PtD. This research has practical and social implications for professionals particularly designers, by providing a broad perspective on PtD adoption and PtD tool usage. It provides insights for BIM software developers highlighting potential areas for tool development. The project contributes to the body of knowledge of PtD tools which will benefit from this baseline study on current tools and exploration of potential areas for BIM tools.

Keywords: risk assessment, BIM, design, PtD, safety

INTRODUCTION

Construction continues to result in frequent loss of life, injuries, near-misses, and collateral damages which can be prevented through design considerations for safety. However, designers' interests in worker safety remain low. Gambatese et al. (2005) found that designers ranked "quality of work" their highest priority and "construction worker safety" as their lowest. "Final occupant safety" is ranked as second in this list followed by "project cost", "project schedule" and "aesthetics".

Factors contributing to the low attention to workers' safety are the lack of tools and resources that assist designers and engineers. Current approaches in the field are primarily text-based check-list-type tools either accessed via paper or software

²⁰ kuk@philau.edu

interfaces (e.g., CII IR101-2, Design for Construction Safety Toolbox, 2011), and are applied manually to design drawings or in construction documentation in the field (e.g., by in-the-field tablet computers). Past safety research shows that the construction industry lacks design support tools for hazard identification and control in the early phases of design and planning (Ku and Mills 2010).

On the other hand, performance-based design approaches supported by BIM are becoming state-of-the-art practices (Hänninen 2006). BIM tools with parametric capabilities linked to various simulation tools offer the ability to rapidly generate and evaluate many design alternatives in the search of successful schemes (Akin 2002). Adopting this trend, the US AIA offers energy modelling guidelines incorporating BIM processes as an important area of performance modelling (AIA 2012).

In parallel, design risk management focusing on health and safety risks (Griffiths and Griffiths 2011) has evolved from design management processes (Gray and Hughes 2001). Adding to the scope of design reviews which consider reliability, serviceability and maintainability of the building, assembly tolerances, buildability, aesthetic criteria, failure modes and fault analysis, etc., design risk management involves risk assessment with a process of hazard identification, consideration of the risk and best design action to avoid, reduce or transfer the risk to another party for action.

The performance-based design paradigm is offering rational ways of addressing several types of risk in built facilities and environments such as structural collapse, damage, comfort, quality of life and preservation of cultural and historical values (Augusti and Ciampoli 2008). Performance based design shifts the focus of design objectives from ensuring engineering solutions at a minimum cost in a deterministic context to aiming at minimizing the total probabilistically calculated losses or life cycle costs. However, defining the problem of health and safety into probabilistic approaches is a significant challenge. Furthermore, optimizing health and safety design considerations with multidisciplinary performance criteria of aesthetic, social, ethical, and financial aspects requires simultaneous research in the areas of design risk assessment, performance-based design and BIM. To provide a baseline of performance driven design approaches in design risk assessment for health and safety, this research examined existing design tools for safety and health, and the effectiveness of these tools in practice. The use of current BIM tools and methodologies were investigated to identify opportunities for new tools.

RESEARCH METHOD

This investigation was part of a three stage research (Ku 2013) defining the baseline of most commonly used tools and effective strategies in designing for safety construction, maintenance, and operations, and the potential opportunities for BIM tools to improve such processes. Findings from the second phase are presented in this paper. The second stage was based on an online survey on the most commonly used tools and effective strategies, type of design tools used for construction, maintenance/operations, compared by disciplines and comparisons of countries. The survey collected data on common usage of BIM for safety considerations and revealed which types of PtD (Prevention through Design) tools provide potential for integration with BIM and the shortcomings of BIM for PtD.

The survey questions incorporated input from expert panel interviews conducted during the first phase which helped to focus the scope of survey.

The online survey was distributed via SurveyMonkey (<https://www.surveymonkey.com>) between May 23 and June 21, 2013, to reach a broad sample of participants. Architecture, engineering, health & safety professionals and construction firms were identified. Contacts were collected based on various online sources, industry connections, and regional and international professional trade organization chapters. 459 individual contacts of architecture, engineering, and integrated design/engineering/construction firms were identified based on Engineering News Record (<http://enr.construction.com/toplists/>) and individual companies websites, 75 architects in the Philadelphia Region, 17 US professional organizations (e.g., AIA and ASCE, structural engineers regional chapters in New York City, Philadelphia, Chicago, Los Angeles, etc.) and corresponding chapters in the UK (8 RIBA chapters and 12 ABE chapters) and Australia (12 RAI A chapters-subcommittees and 5 engineering association chapters). The survey link was also posted on social network LinkedIn (<http://www.linkedin.com/>) interest groups - the Safety in Design and Safety in Design UK group. A total of 141 people responded of whom 138 were included in the analysis as they responded by the deadline.

The survey was broken up into six subsections including: (1) Demographics, (2) General Design Protocol/Procedures & BIM, (3) Prevention through Design (PtD), (4) Standards/Regulations, (5) Tools and Procedures, and (6) Final Remarks. Key results from the survey are selectively presented below.

SURVEY RESULTS

Demographics

Regarding the country of practice, 69% of the respondents practiced in the US, while the numbers of UK and Australian participants were equally at 14%. People from countries outside of these three comprised just 3% of responses.

Respondents were allowed to check multiple roles for their profession as it was anticipated that certain professionals would have multidisciplinary responsibilities and backgrounds. The roles were then condensed into 5 categories including architect, engineer, construction manager, H&S professional, and other, accounting for primary roles. The majority indicated a single primary role; others indicated multiple roles such as architect and engineer, or construction manager and H&S professional. The "Other" category comprises people who did not identify as Architect, Engineer, Construction Manager, or H&S Professional and included Trademan, Software Developer, Facility Manager, Developer, Academic/Educator and a few others. Figure 1 shows the distribution by profession, architects being the largest group.

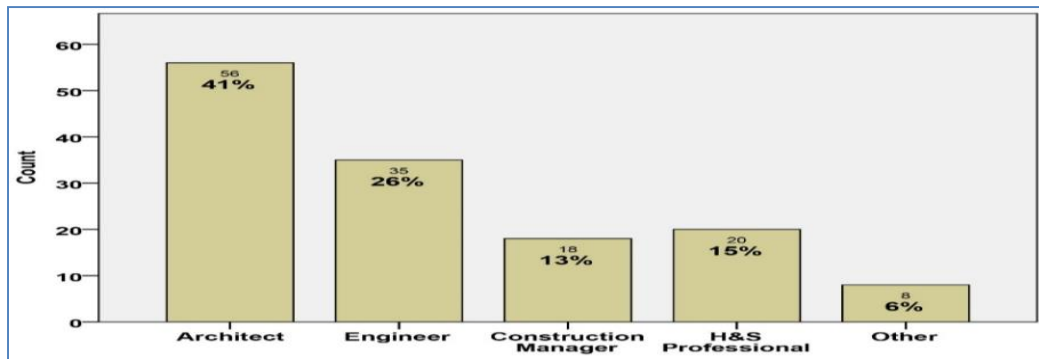

Figure 1: Demographics by profession

In terms of positions within companies, the largest number of respondents indicated they were at the Executive/Principal level (45%), while Senior Project Managers and Project Managers made up 28% and 20%, respectively. Junior and Entry level employees made up just 7% of the respondent pool.

72 of the 138 respondents completed the survey at a completion rate of 52%. The drops in the survey population progressively coincided with the sections which moved from general practice questions towards more specific safety design practice and tools questions.

General design procedures and BIM

The survey asked about general design review procedures where the majority of engineers (89%) and architects (80%) indicated participation in design reviews frequently while only half of H&S Professionals participated in design reviews. This question was used as a filter for the following question asking about the purpose of the review. Those participating in design reviews were asked about the purpose. The top response was Code Compliance (17%) and General Design Revision (17%) and Constructability (16%) followed third. Overall, construction (9%) and Maintenance worker's safety (8%) were lower priorities. For US respondents construction and maintenance worker's safety were lower priority compared to their UK and Australian counterparts.

To understand company infrastructure, the survey questioned usage of BIM. The US exhibits a far higher usage of BIM tools at 69% (of 78) compared to 56% (of 16) in the UK and 44% (of 18) in Australia.

Revit was the most reported BIM platform to be used by the respondents at 48% while four major BIM applications were identified. The first and second applications were clash detection and coordination (14%) and design configuration/scenario planning (14%). The third and fourth applications were design communication, presentation, review (13%) and space planning & program compliance (12%).

Prevention through Design

Section 3 of the survey, entitled "Prevention through Design", focused on the respondents knowledge of PtD, as well as practices and attitudes associated with its implementation. One question was designed to establish if knowledge of PtD exists in the survey sample. In this check-all question, the respondents were given the choice of PtD, CHPtD, Design for Safety, Safety in Design, Other similar Concepts, and finally "Do Not Know". The results show that general knowledge of PtD by Architects in the US is low, while the small sample of UK and Australian architects

were aware of the concept. Other professions in the US including Engineer, Construction Manager, and H&S Professional showed more knowledge of PtD, however represented a smaller sample size.

To a question about whether the respondent thought considering safety during design can improve worker's safety and health, 92% (of 105 respondents) reported it could be improved.

Survey participants were asked about their experience with both hazard identification and risk assessment in Construction Safety, Maintenance and Repair, and Demolition. Figure 2 relates this data by profession. Across all professions, respondents had the most experience in Construction Safety compared to maintenance and demolition. Interestingly, for both hazard identification, and risk assessment, architects chose “N/A” more frequently than the other choices. These results are biased towards US architects who were the largest group in the demographics and illustrates that the architects do not apply hazard identification or risk assessment for worker safety.

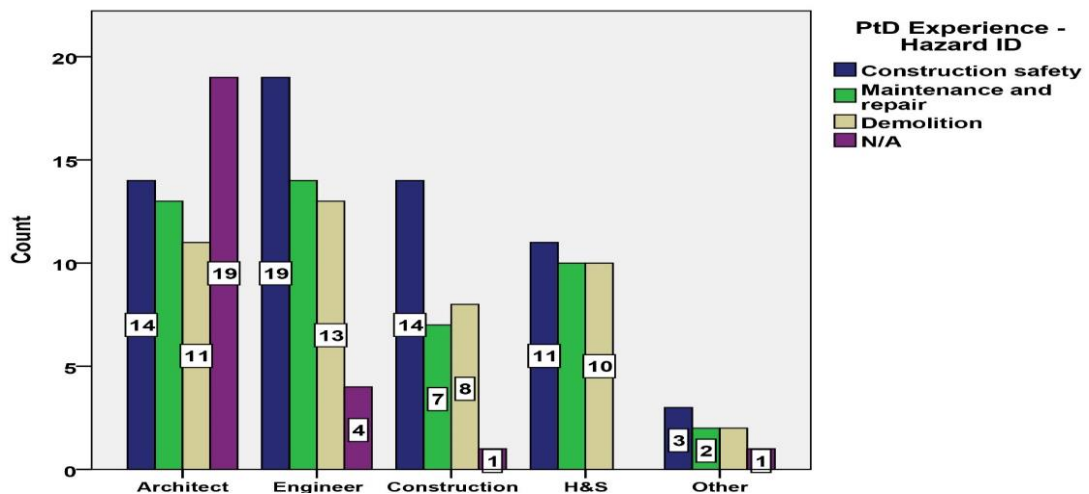

Figure 2: Hazard identification experience by profession

The survey continued with a follow-up question about the hazard prevention concept known in the UK as ERIC - the acronym for “Eliminate the hazard, Reduce the hazard, Inform of the Risk, Control the risk” - or described as a “hierarchy of engineering controls.” The idea for any given hazard is that if you cannot eliminate it, then reduce it, and if you can’t reduce it, then inform people of it, and so on. The responses show that all professions except for architects have knowledge of this concept. 22 of 38 architects reported that they were not familiar with this method of thinking. This matches the lack of responses for PtD knowledge and shows a trend that the architects in this survey have yet to make safety and hazard prevention a part of their design process.

The next set of questions asked about the design phases during which participants addressed safety and health issues with respect to construction workers, maintenance workers, and demolition workers. For construction worker safety and health issues, design considerations tend to be addressed most frequently during the Construction Documentation phase. Similarly for maintenance workers, however a slightly larger number of respondents indicated the design development phase, meaning that this might occur a bit earlier in the process. For demolition workers, next to construction

documentation phase a larger population selected N/A for the response, indicating that this category is often not considered during design.

Standards and regulations

Section 4 of the survey had a single question about the standards and regulations used by the respondent's practice. In the US, the IBC 2012 standard was listed as the primary standard referenced, with OSHA standards 1910 and 1926 mentioned the second and third most amount of times. In the UK, only two choices stood out as frequently used standards, with the CDM 2007 regulation coming in as the first most reference, and then the Assurance in Construction regulation. Australians also cited the Assurance in Construction regulation, but the majority of respondents listed "Other" as the standard. While not very specific, in the open response section for this question respondents mentioned that Australia has its own set of building regulations and codes that were not on this list.

Design tools and procedures

Section 5 asked about design tools and procedures used in consideration of construction and maintenance safety issues. Figure 3 shows the frequency of responses for each tool broken down by profession within each country. In the US, the tools with most responses across all professions were material safety data sheets and code compliance checklists. Respondents from the UK picked design guides most frequently for the Engineering and H&S Professionals. However, the other professions did not have enough respondents to offer conclusive interpretation. Australia was a small sample size but for the architects code compliance checklists seemed to be the most popular choice.

Similarly the next set of questions required survey participants to rate five types of design tools from "least effective" to "most effective", with an additional option of "N/A". Architects tended to rate code compliance checklists higher, while engineers and health and safety professionals tended to prefer design guides when designing for safer construction or maintenance. When viewed by country, respondents from the US tended to rely more on code compliance checklists, while design guides were favored in the UK and Australia.

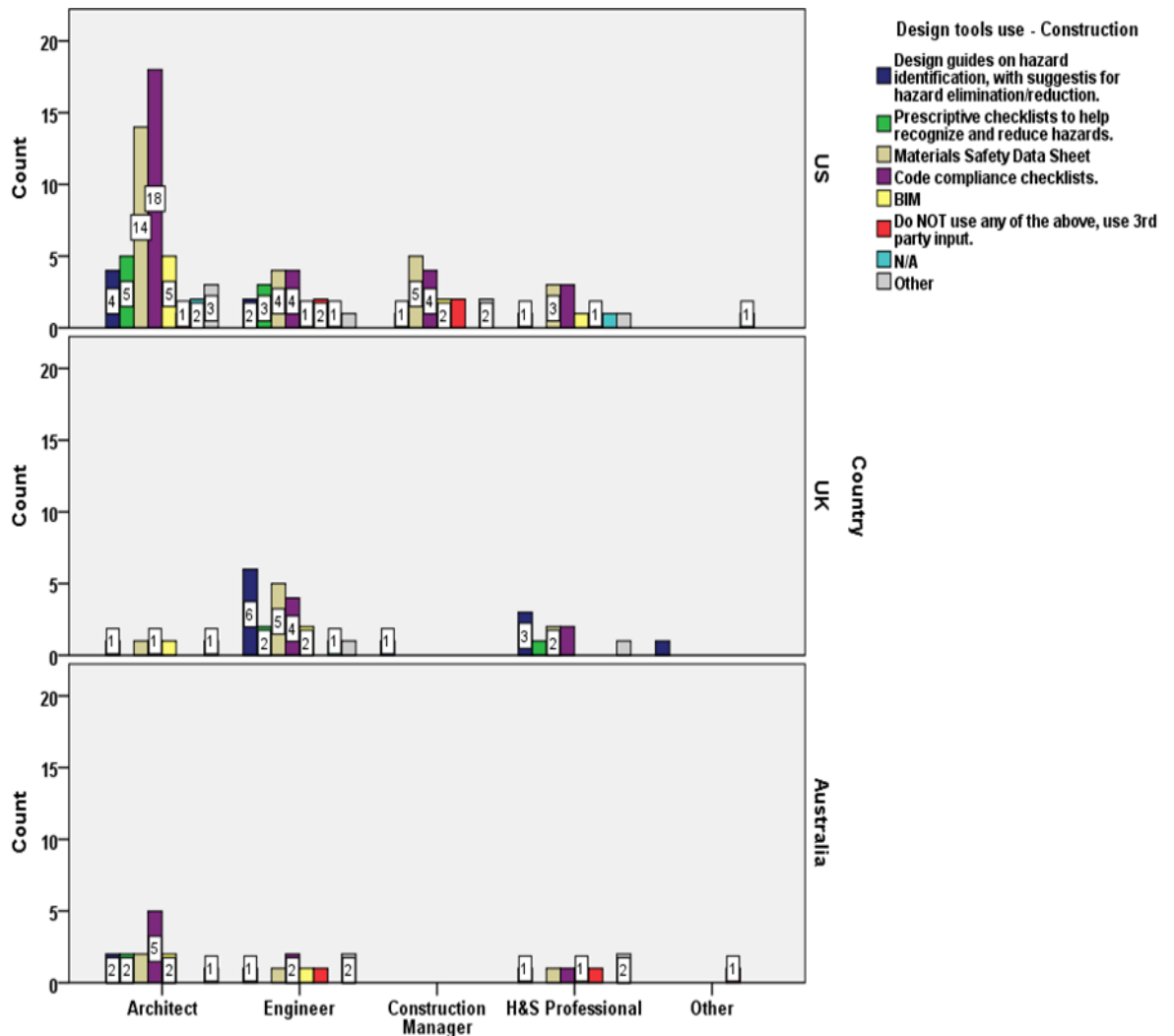

Figure 3: Usage of safety design tools by profession and country

The survey asked respondents to select all of the tools that they have used for risk assessment in their practice. A large number of US architects responded that they do not use any of the risk assessment tools themselves but a number of architects responded they use risk assessment matrices, cost-benefit matrices and colour coding techniques. The UK and Australian sample was small but engineers and H&S professionals named Risk Assessment Matrices most frequently.

Similarly to the previous question, the participants rated the effectiveness from least effective to most effective. Risk assessment matrices were rated higher among architects. Colour coding techniques and residual risk registers, were rated higher amongst engineers and H&S Professionals. Construction managers rated BIM tools highest. When viewed by country, colour coding and BIM tools were rated highest in the US, where residual risk register was rated the lowest. In contrast the UK and Australian participants rated BIM tools as the lowest in effectiveness, while Risk Assessment matrices and colour coding were rated the highest. One question asked respondents to select which methods they used to conduct design reviews. Overall results show that two most popular methods were “Integration throughout the Design Process” and “design reviews at 30%-60%-90% completion points (30-60-90).” When viewed by country, as shown in Figure 4, the “Integrated” and “30-60-90” approaches were the top choices in the US. In the UK, the “Integrated” method received the

majority of responses, but “Specialized review teams” came in with the second highest level of responses. In Australia, the highest number of responses followed the overall trend, showing “Integrated” and “30-60-90” as the primary methods, and the “CHAIR” method was also among top choices.

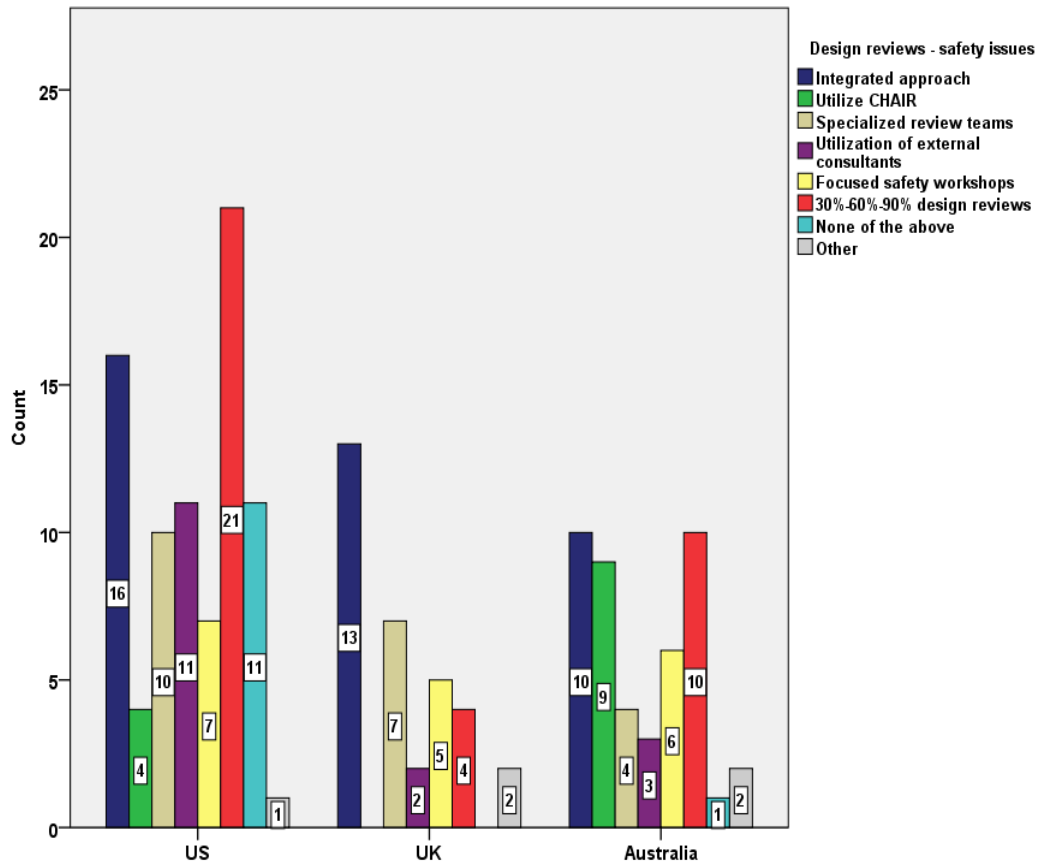

Figure 4: Design review techniques by country

The mean effectiveness ratings for the design review approaches show that the two highest mean ratings are received by the “Integrated Process” and “Review teams within Company”.

By profession, as shown in Figure 5 **Error! Reference source not found.**, the “Integrated approach” was given the highest mean ratings by architects, engineers, construction managers, and members of other professions. H&S safety professionals gave the highest mean rating to “30-60-90” reviews; however, “Integrated Approach” and “Focused safety workshops” were given equal and slightly lower mean ratings.

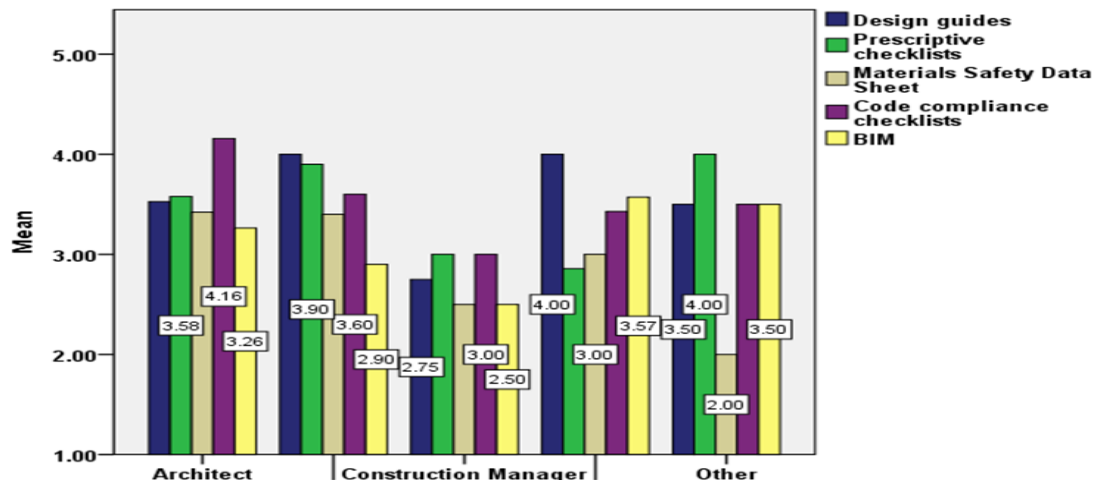

Figure 5: Design review techniques effectiveness rating by profession

Error! Reference source not found. Analysing the mean effectiveness ratings by country, the “integrated approach” had the highest mean effectiveness rating across all countries. “Utilization of external consultants” in this view, seems to have the lowest effectiveness of all of the options.

Regarding use of digital models, 3D models were the most popular type of digital models utilized in safety design (25%). However, an equal number of people indicated that they do not use models to consider health and safety issues. And 4D sequence visualization was used by only 14%. Further filtering the result by profession reveals that architects think 2D modeling has a slight advantage over 3D and BIM tools, while 4D/Sequence modeling had few respondents across the disciplines. There was also a sizeable portion of architects who do not use models for safety. For engineers some indicated that they use 3D models but the majority responded N/A. While response numbers were lower for construction managers and H&S professionals, 3D modeling had received the most responses out of this group.

The next question asked respondents to select the design phases during which they typically use a selection of safety design tools. For concept/schematic design, in the US, a large number of the sample does not use any design tools. For those that use tools however, the most popular tool was the design guide. In the UK and Australia, the most popular response was risk assessment tools. During design development phase, a large number of US respondents indicated they do not use safety design tools but those who use design tools responded BIM/Visualization tools and design guides as their main tools. UK and Australian respondents again chose risk assessment tools most frequently during this phase of the project. Hazard identification checklists and design guides were chosen as the second and third highest responses for these countries.

For construction documentation phase, most US respondents indicated the use of BIM/Visualization tools. Respondents from the UK and Australia answered similarly as in the previous project phases, choosing risk assessment tools as the primary tool used, followed in both cases by hazard identification checklists.

The next set of questions asked about the main collaborators using hazard identification checklist, design guide, risk assessment tool, and BIM/visualization tool. Across the three countries and the four different tools, in-house design teams were indicated mostly while each tool varied in terms of other collaborators

including the owner, external design and construction team. BIM/Visualization had the greatest popularity in the US within the in-house design team, while external constructors, owners, and external design teams had also high response frequencies. Asked about the overall usefulness of tools and processes in identifying and improving worker safety, architects rated design guides as the most useful tool while engineers selected hazard identification checklists most often. In contrast, construction managers found BIM/Visualization tools to be most useful identifying issues and improving worker safety, while H&S Professionals found design reviews to work the best.

The next set of questions asked to indicate the main benefits of hazard identification checklists. The most selected benefits were “Enhances Communication Internally”, “Facilitates structured safety reviews”, and “Improves Evaluation of Hazards”. Asked about the main benefits of design guides, respondents selected “Enhances Communication Internally”, “Promotes Creative Solutions”, and “Improves Evaluation of Hazards” as the top three responses. Then asked to select the main benefits that Risk Assessment Tools provide, the greatest benefits identified were “Enhance Communication within Internal Team.” Secondary benefits were “Facilitates structured review of safety issues” and “Facilitates evaluation of multi-disciplinary design issues”. Lastly, about the benefits of BIM/Visualization tools, the highest frequency response was “Enhances communication within internal team”, while “Facilitates evaluation of multidisciplinary issues” and “enhances external communication”.

CONCLUSIONS

The survey attempted to provide a benchmark of current PtD processes and evaluate their perceived effectiveness. Because of the varying sample sizes between different disciplines and countries, it is difficult to draw conclusive comparison between these different groups. The data requires further analysis to clarify biases of responses. However, the sample offers insights into the different industry contexts which align with respective regulatory contexts and practices. The results align with expectations based on literature. For example, the UK and Australian respondents show higher awareness of PtD related concepts and adoption specific practices of risk assessment and design guides whereas US practitioners rely more on prescriptive means (e.g., code compliance checklists, material safety data sheet). This obviously may be the result of the sample bias but it establishes the foundation for a baseline study and helps to verify a number of opportunities:

US practices have a larger BIM base which provide opportunities to incorporate emerging design risk assessment best practices

US practitioners showed a higher awareness and usage of PtD practices and process than expected

US design practices highlight a gap in the general knowledge base of PtD and demand educational and legislative efforts to address this gap

There are lessons to be learned from UK and Australian counterparts' safety design best practices

Safety design tools need to address both internal design team processes and external team processes.

BIM for safety purposes in the US is mainly driven by contractors.

BIM and visualization tools lack integration with current best practice tools for hazard identification, risk assessment and other design processes. The majority of the survey participants do not use software that assists evaluating hazards in designs and/or proposing alternative solutions to aid design decision making. Only a limited number of US participants mentioned the use of rule checking software like Solibri (<http://www.solibri.com/>), as well as BIM tools in Revit, Tekla (<http://www.tekla.com/us/>), etc. Some other software mentioned were Dyadem and Primetech. Many of the respondents believe that BIM can help designers to consider occupational safety and health during design more effectively. This requires improving and customizing content of the BIM tools. The study results offer a positive outlook for designing for construction worker safety with potential advancements in BIM to better visualize hazards during design.

ACKNOWLEDGEMENTS

This work was supported by Grant Number 7R03OH009982-02 from the Centers for Disease Control and Prevention (CDC). Its contents are solely the responsibility of the author and do not necessarily represent the official views of CDC.

REFERENCES

- AIA (2012) "An architect's guide to integrating energy modeling in the design process". American Institute of Architects Energy Modeling Working Group, from <http://info.aia.org/aia/energymodeling.cfm>
- Akin, Ö (2002) Variants in Design Cognition. In C. Eastman, M. McCracken and W. Newstetter (eds.) "Design Knowing and Learning Cognition in Design Education.. Amsterdam, Elsevier: 105–124.
- Augusti, G and Ciampoli, M (2008) Performance-Based Design in risk assessment and reduction. "Probabilistic Engineering Mechanics", 23(2008), 496-508.
- CII (2011) "Addressing Construction Worker Safety in the Project Design", RR101-11, Univ. Texas Austin.
- Gambatese, Jgray A, Hinze, J, and Behm, M (2005) "Investigation of the viability of designing for safety", The Center to Protect Workers' Rights, Silver Spring MD.
- Gray, C and Hughes, W (2001) "Building design management". Oxford: Elsevier Science.
- Griffiths, O V, Griffiths, A V (2011) "Understanding the CDM 2007 regulations". Oxon: Spon Press.
- Hänninen, R (2006) "Building Life-cycle Performance Management and Integrated Design Processes: How to Benefit from Building Information Models and Interoperability in Performance Management W. S. S". Invited presentation, Stanford University. Stanford.
- Ku, K (2013) Comparing safety in design approaches and tools in the US, UK, and Australia, In: Kajewski, S, Manley, K., Hampson, K, "Proceedings of the 19th CIB World Building Congress, Brisbane 2013: Construction and Society", Brisbane: Queensland University of Technology
- Ku, K and Mills, T (2010) Research needs for Building Information Modeling for Construction Safety, Int. Proc. Associated Schools of Construction 45nd Annual Conference, Boston, MA.

PREVENTION GUIDE FOR DESIGNERS BASED ON ANALYSIS OF ABOUT 2000 ACCIDENTS

Alfredo Soeiro²¹, Bianca Silva and Beda Barkokebas²

¹ *DEC-FEUP, R. Dr. Roberto Frias s/n, PT-4200-465 Porto*

² *Politecnica, Universidade Recife, Rua Benfica, 455 - Madalena - Recife/PE CEP: 50720-001, Brasil*

Accident prevention in the design stage of the project is characterized by proactive and effective actions, and analyzing the risks of accidents at the beginning of the life cycle of the project can ensure that safety measures at the stage of implementation, of maintenance and of deconstruction are already in place. This thesis aims to contribute to filling this gap by presenting a proposal for a management model of the prevention of risks of accidents at work at the design phase. This model was obtained by analyzing accidents at work occurring in the construction sector in order to identify links between the causes of accidents and the designs. In order to do this analysis the MAARD-Method of Analysis for Accident Related Design was created and applied. The method results in an analysis in which a conclusive answer can be obtained about the existing link between the causes of the accident and the different types of designs in order to determine which could be involved. The preventive measures to be implemented in design phase were also determined. Based on the analyses of accidents a framework for designers was created. The framework originated a model called MMPtD - Management Model for Prevention through Design. This model consists mainly of a guide that may help designers decide measures to prevent risks during construction. Another conclusion from the study was that an average of 60.8% of the accidents could have been prevented during the stages before construction. Excluding the planning phase from this analysis an average of 35.1% of accidents could have been prevented with measures during the conceptual design. Of these designs architecture and structure designs were singled out as projects of greater impact in the prevention of accidents.

Keywords: accident prevention, construction, designs, risk analysis, safety at work.

INTRODUCTION

The construction sector stands out with one in six fatalities occurrences in labour accidents. Per year, it is found at least 60,000 deaths at construction sites around the world, leading to an estimate of a deadly accident every ten minutes (ILO, 2010). The EU countries accounts for less than 2% of fatal occupational accidents at work places in the world. In WHO regions the statistics point out Asia and the Pacific region with 64% of the 60.000 fatal accidents at work, followed for Americas (17%), Africa (10%) and Europe (9%) (Dias, 2005).

In numbers, around 1,300 workers per year are victims of fatal accidents in construction sites in the EU. That is equivalent to 13 employees in each 100,000, i.e. more than twice the average of other sectors. According European Commission (2004) and EU-OSHA (2009), the costs of accidents are of particular concern to small and

²¹ avsoeiro@fe.up.pt

medium-sized enterprises because SMEs account for 82% of all occupational injuries and 90% of all fatal accidents. The European Foundation for the Improvement of Living and Working Conditions (1991), through a study conducted in 1991 says that 60% of fatalities are coming from decisions taken before the commencement of activities of the construction sites and could have been avoided with the adoption of appropriate measures at the design stage.

The main motivation for this study was the creation of a safety coordinator in the design stage by the Directive 92/57/EEC - Temporary or mobile construction sites. The directive justified the creation of this activity mentioning that:

“Whereas unsatisfactory architectural and/or organizational options or poor planning of the works at the project preparation stage have played a role in more than half of the occupational accidents occurring on construction sites in the Community;”

However no supporting data was found in a thorough research about the origins and causes for the above quoted statement about over half of accidents being prevented in the preparatory stage of construction works. Therefore a study was performed to verify the value by a doctoral student from the University of Recife, Brasil supervised at the University of Porto, Portugal between 2009 and 2013. (Silva, 2013).

PREVENTION THROUGH DESIGN

The Prevention through Design – PtD is a relatively recent concept in order that the first research and publications dating back in the early 1990’s. This work, has adopted the concept defined by the National Institute for Occupational Safety and Health – NIOSH (2010), in which the PtD is seen as the "Addressing occupational safety and health needs in the design process to prevent or minimize the work-related hazards and risks associated with the construction, manufacture, use, maintenance, and disposal of facilities, materials, and equipment."

Accident prevention through design was first suggested in the Accident Prevention Manual from the National Safety Council – NSC in 1955. However, further initiatives may be cited. Research undertaken in the 1990’s, that was funded by the Construction Industry Institute-CII in the United States, ended with the production of a computational tool for designers. Currently, several countries like the United States, Australia and European Union countries are engaged in studies on the prevention of accidents through the design, with groups of specific jobs to use as examples.

In the US, many owners of construction companies have had major safety concerns in their projects, starting from contractual decisions when they hire companies who are most committed to safety. The responsibility for safety in the workplace is first placed to the employer, - usually the general contractor - many companies fail from security procedures in the light of the high costs arising from occupational accidents (Gambatese and Hinze, 1999). Thus, many business owners encourage designers to incorporate safety at work on their designs. Some designers, especially those of design and construction companies, already include safety in their designs.

In Australia, the Australian Safety and Compensation Council - ASCC is the largest organ responsible for OSH Regulations Act, which replaced the NOSH in October 2005. It is a tripartite body which emanates consultative guidelines for voluntary compliance integrated by the laws of each jurisdiction, i.e. for each State of the Commonwealth, - called the Australian Central Government.

In 2002, States, territories and the Commonwealth Ministers, leaders of the Australian Chamber of Commerce and Industry and the Australian Council of Trade Unions signed a 10 year national strategy for safety at work. The national strategy establishes two goals to achieve by June 30, 2012: reduce fatalities by at least 20% and reduce the incidence of injuries at least 40% (Creaser, 2008). One of the studies databases to establish the elimination of risks in the design phase as the fourth priority refers to the investigation of accidents occurring between July 2000 and June 2002 in Australia, they were verified aspects related design (Driscoll et al., 2008).

In the EU, the duty to implement safety was the responsibility of the contractor as the performer of the work, but the legislation has changed this situation and implementation of prevention measures is not dependent on the contractor's only but also on the owner and on designers. This integration is justified by the fact that decisions of preventive measures taken at design level are related with safety coordination activity, that in itself is also a design (Soeiro, 2009).

In the United Kingdom, the transposition of European Directive 92/57/EEC of June 24, 1992, through Construction Design Management Regulations 2007 – CDM 2007 required that designers consider aspects of occupational safety in all phases of the construction, and it will be subject to litigation, fines and imprisonment. The CDM emphasizes the identification and assessment of risks, and determines the required steps for the integration of safety at work in the design, involving the designer directly. The Health and Safety Executive - HSE created the Safety in Design – SID, an entity that seeks to share ideas, suggest choices, educate and inform concerned professionals about their performance and duties (CDM, 2010).

DESIGN AND CONSTRUCTION SAFETY

The designer has been identified as a construction worker holding great impact on safety at work. Historically, although designers do not take into account the safety in designs and often are not aware of the impacts of their decisions design in the safety of construction. The development of design is an activity of increasing complexity. It surpasses the technical concepts as commonly used and requires an overview of the various businesses involved and other aspects of activity.

Some authors distinguish design management to design coordination, featuring management as an activity linked to the development of generic procedures and coordination activity specifically linked to implementation in a given undertaking. They define the design coordinator as the principal agent in the management of the design process and have their principal tasks as performing actions of integration between designers; coordinating and controlling designs and exchanges of information in order to ensure that the design process meets deadlines and objectives.

In the European Union, there is also the coordinator for safety and health in design phase, defined as the natural or legal person, who performs during the preparation of the design, the tasks of coordination in the field of occupational safety and health, provided for in applicable legislation, and may also participate in the preparation of the contract negotiation process and other preparatory acts of construction works, concerning safety and health at work (Portugal, 2010).

In the field of occupational safety, design solutions already exist for most problems, but the challenge is to make changes to ensure that risks and hazards can be eliminated and/or minimized at source (Creaser, 2008). Don't just point out what to

do; you need to show how to do, i.e. define methods for the viability of the insertion of the safety considerations in the planning stage. Many designers fail to show how their designs can ensure the safety of future workers. In addition there are too few tools and materials available for queries in order to assist them in recognition of risks and the adequacy of their designs.

STUDY ACCOMPLISHED

To understand the functioning of safety at the design stage, some questions are required, such as: What are the tasks in each type of design? How would be the workflow design? How would be the management of the flow of work and information? Other issues were also raised: Does the few existing manuals and computational tools in support of the originator apply to any region? Should there be an adaptation to the conditions of cultural, social and economic individuals to each location? Is it from the analysis of the causes of accidents at work, according to official data, that we can detect relationships with the design?

With the intention of answering some of these issues and in order to assist designers and construction owners directly, a study was done with the aims of producing a model for the integration of safety at work in the design process using a practical guide for designers containing guidelines for safety at work. This analysis was based on the development of a risk assessment method for the design phase.

The model aimed at contributing in the prevention of risks of accidents in construction during the lifetime of the project (planning, implementation, maintenance and deconstruction), taking into consideration design decisions, accident risks and control measures.

The research study consisted of the following steps:

- a) Identification of key stakeholders (owner, co-ordinator, designers, etc.) and their respective duties in construction safety, specifically in the sub-sector of buildings;
- b) Analysis of the design process;
- c) Search for statistics on construction accidents in order to understand the underlying causes and respective risks that originated the accident;
- d) Analyze case studies in order to establish the possible links between the causes of the accident and the design decisions;
- e) Method to assess risks at the design stage that could be eliminated or alleviated;
- f) Guide for designer containing guidelines for preventing accidents at the design phase.

RESULTS AND CONCLUSIONS

Literature in general presents the benefits of preventing accidents through design, show project viability, and makes projections for the future. Furthermore, in some countries the legal responsibility of safety in the workplace is also shared with the designer. However, practical material available to the designer is still lacking. Considerations of safety at work in practice are insufficient and there are still many difficulties and lack of awareness. In order to make prevention through design, it is necessary transformations in the attitude of project stakeholders, moved by awareness

instead of law force. The safety at work is a responsibility of all society, and designers are holders of expertise. They have at their hands a great potential to promote safety thorough their designs.

The number and sources of accidents analysed was diversified in terms of sources. The accidents were obtained directly from public sources and from one Brazilian construction company. This data from public sources was obtained from reports of accidents available for the public. The data obtained from the construction company was obtained from consultation of the company records.

The numbers of accidents analysed in this study were 675 from the construction company in Brasil, 940 from CCOHS in Canada, 116 from FACE, NIOSH and PtD in USA, 203 from ACT in Portugal, 100 from HSE in United Kingdom, 41 from WSH Council in Singapore and 32 from SFIT in Brasil. The period of time when accidents were analyzed was from 1995 until 2012.

This data obtained from the analysis of about two thousand fatal or serious accidents originated the following conclusions about the percentage of accidents avoidable in design phase:

- a) Minimum found in one of the countries - 23.6
- b) Maximum found in one of the countries - 45.0
- c) Average for the total of accidents in the seven countries- 35.1

These values were obtained using the MAARD model described ahead. The main considerations of the method were: a) accidents occurred because there were risks taken; b) some of the risks could have been avoided taking preventive measures at the design stage; c) percentages were obtained counting the number of accidents where the preventive measures could have been taken and, as consequence, the accident could have been avoided. Countries have different processes for accounting fatal accidents in terms of period of monitoring the accident, of the place where death was declared or recording the accidents in public reports. Besides these differences there were other possible reasons to have these differences like working methods, design procedures and safety control at design phase. These disparities may explain the variation of values.

Taking into account the different type of designs (infrastructures, superstructures, mechanical, electrical, HVAC, architecture and water systems) two models were created to help the prevention of accidents at the design phase. These were called MAARD (Method of Analysis for Accident Related Design) and MMPtD (Management Model for Prevention through Design). (Silva, 2013).

For designer guidance the model, designated as MAARD (Method of Analysis for Accident Related Design), is composed by a matrix that relates the frequency and the gravity of accident with the possible preventive measures to be considered at the phase of design. These preventive measures were chosen based on the risks that created the accident analysed. The measures were identified as possible to be decided during the design phase. This tool allowed the conclusion of how many accidents could have been prevented at the design phase, planning phase and construction phase.

The second tool created based on this research study was MMPtD (Management Model for Prevention through Design). It is composed of four sets of checklists that are supposed to be used by designers according to the respective type of design:

architecture, structures, infrastructures and mechanical/electrical installations. These four guides are practical tools that can be used by any designer without an enlarged knowledge about prevention of accidents. This guide is expected that, if widely used by designers, there will be a serious reduction of accidents in construction since more preventive measures were taken at the design phase. Both tools are available for public consultation and can be obtained from the authors of the article.

As a further reflection about future research and about arising issues the following questions can be made:

a) Is it worth having a safety coordinator at design phase? The percentage of accidents that could have been prevented in the design phase is below the value presented in the directive. Taking into account that the fact that one accident prevented is reason enough to have a safety coordinator in the design phase the question is if the reason invoked in the directive is still valid. Further research could be done to benchmark the current results. The number of accidents analysed is large in total but reduced in each of the sources from the different countries.

b) Is it better than the safety coordinator at design phase to use a guide for designers to prevent accidents? The effectiveness of safety coordinator at the design stage can be replaced by a wider and globalised use of MAARD and MMPtD tools if accepted by the designers' community. Here the professional associations and regulatory agencies can have a significant impact in accident prevention.

c) How can this study work with others already done and with future research? In fact an organized and systematic effort should be made to research and to analyse accidents that occurred. It is important to learn from these accidents so the accidents that could have been prevented do not happen anymore. For this initiative it would be important to have public data and investment in research and analysis. Technological platforms can be used to manage the knowledge about the preventive measures in construction.

REFERENCES

- Autoridade para as Condições de Trabalho - ACT (2010). Estatísticas. Available: <http://www.act.gov.pt/%28pt-PT%29/CentroInformacao/Estatisticas/Paginas/default.aspx>. Access 05 jun. 2010.
- Brazil. Ministério do Trabalho e Emprego. Normas Regulamentadoras. Available: <http://www.mte.gov.br>. Access: 10 feb. 2010.
- Construction Design and Management – CDM. Available: <http://www.hse.gov.uk>. Access: 11. Jun. 2010.
- Creaser, Wayne (2008). Prevention through Design (PtD) Safe Design from an Australian Perspective. *Journal of Safety Research*. 2008, v.39, p. 131–134.
- Dias, L. A (2005). Segurança e Saúde do Trabalho da Construção na União Europeia. *Segurança*, 2005, n.169, p.7-22.
- Driscoll, Timothy R.; Harrison, James E.; Bradley, Clare; Newson, Rachel S. (2008). The Role of Design Issues in Work-Related Fatal Injury in Australia. *Journal of Safety Research*. 2008, v.39, p. 209-214.

- European Agency for Safety and Health at Work – OSHA/EU – OSHA/EU (2009). Occupational safety and health and economic performance in small and medium-size enterprises: a review. Office for official publications of the European Communities. Luxembourg.
- European Agency for Safety and Health at Work – OSHA/EU (2010). Statistics. Available: <<http://osha.europa.eu/en/statistics/>>. Access: 20 jun. 2010.
- European Foundation for the Improvement of Living and Working Conditions (1991). From drawing board to building site (EF/88/17/FR). European Foundation for the Improvement of Living and Working Conditions, Dublin.
- Gambatese, John A.; Hinze, J. (1999). Addressing construction worker safety in the design phase: Designing for construction worker safety. *Automation in Construction*. 1999, v.8, p. 643–649.
- Gambatese, J. A.; Hinze, J.; Haas, C.T. (1997). Tool to design for construction worker safety. *Journal of Architectural Engineering*. 1997, v. 3 (1). p. 32-41.
- International Labour Organisation – ILO (2010). World day for safety and health at work 2005: a background paper. Available: <http://www.ilo.org/public/english/bureau/inf/download/sh_background.pdf>. Access: 03 sep. 2010.
- National OHS Strategy 2002 – 2010. Available: <<http://www.safeworkaustralia.gov.au>>. Access: 11 jun. 2010.
- National Institute for Occupational Safety and Health – NIOSH The National Occupational Research Agenda – NORA. Available: <www.cdc.gov/niosh/nora>. Access: 30 may 2010.
- Oliveira, O. J. (2004). Gestão do processo de projeto na construção de edifícios. *Integração*, 2004, ano X, n. 38, p. 201-217.
- Portugal. Portaria n.º 701-H/2008 de 29 de Julho. Available: <<http://www.base.gov.pt>>. Access: 09 sep. 2010a.
- Reis, C. M.; Soeiro, A. (2005). Economia da segurança e dos acidentes na construção: simulação e análise. ISHST, Lisboa.
- Revista Proteção. Construção civil terá alto índice de acidentes. (2010). Available: <http://www.protecao.com.br/site/content/noticias/noticia_detalhe.php?id=AJy5AJ>. Access: 10 may 2010.
- Silva, B. (2013). Segurança no Trabalho na Construção - Modelo de gestão de prevenção de acidentes para a fase de concepção. Doctoral (PhD) thesis, Universidade do Porto, FEUP Edições, Porto.
- Soeiro, A. (2009). A importância do projecto na prevenção de acidentes na construção. *CdO Cardernos d’Obra*. v.1, n.1, p.106-108, Porto.
- European Union (1992). Directiva 92/57/CEE do Conselho, de 24 de junho de 1992. Available: <<http://europa.eu.in/eur-lex/>>. Access: 10 feb. 2010.

INTEGRATED SAFETY IN DESIGN

Casper Siebken Schultz²² and Kirsten Jørgensen²

¹ *DTU Management Engineering, Technical University of Denmark, Produktionstorvet bygn. 424, 2800 Kgs. Lyngby, Denmark*

² *DTU Management Engineering, Technical University of Denmark, Produktionstorvet bygn. 424, 2800 Kgs. Lyngby, Denmark*

An on-going research project investigates the inclusion of health and safety considerations in the design phase as a means to achieve a higher level of health and safety in the construction industry. Moreover, the approach is coupled to the overall quality efforts. Two architectural firms and two consulting engineering firms are project participants. The hypothesis is that health and safety problems in execution can be prevented through better planning in the early stages of the construction processes and that accidents are prevented by providing safety. In the first stage of the research project a theoretical framework is developed from a combination of existing literature on health and safety and a mapping of existing practices based on interviews in all four companies. The interviews revealed that the basic knowledge on OHS among architects and engineers is limited. Also currently designers typically consider OHS in execution as a responsibility of the contractors. The output of this stage is a systematic and structured conceptual framework that couples OHS-risks in construction (health, safety and mental health) to the stages in the design and engineering processes. Moreover the framework includes a focus on processual elements, constraints and prevention strategies and also includes a tool to address OHS risks in the design processes. The approach stresses how complying with legislation should only be seen as a minimum condition in design and engineering. Incentives to prioritize OHS in design and the possibility to cultivate OHS under agendas on quality and sustainability are discussed. The second stage of the project test the framework from intervention on up to four construction projects followed by an evaluation of the results and processes.

Keywords: Construction, design and build, health and safety, intervention

INTRODUCTION

Over the last decade the rate of accidents in the Danish construction industry has been almost constant between 24.4 to 30.7 accidents per 1,000 persons employed between 2003 and 2012. In Denmark the rate of accidents in the construction industry was 30.7 accidents per 1,000 persons employed compared to an accident rate of 11.3 in Sweden. Different methods of registration are possible explanations to some of the difference but the numbers are alarming. To formulate an agenda with occupational health and safety as an integral part of the construction projects overall social sustainability approach can be an instrumental way to promote the well-being of employees in the highly profiled agenda on sustainability.

²² cass@dtu.dk

The employees being subject to injuries or fatalities in construction are mostly connected to the onsite processes and the execution phases since this is where the employees are exposed to the primary occupational hazards. In Denmark historically the primary facilitator of safety work has been the contractors and initiatives to enhance occupational health and safety (OHS) in the construction industry are often directed towards stakeholders in the execution phases. However already in 1991 the EU documented that a third of the occupational accidents in the construction sector are results of errors in the client's and the consultant's detailed design and engineering, and 1/3 are a result of flaws and defects in the contractor's planning (European Foundation for the Improvement of living and Working Conditions, 1991). This formed the foundation for EU regulations that in Denmark, however, were not deployed through legislation until 2008 inter alia to impose a statutory health and safety coordinator in the design work. Also a number of scholars emphasize how design forms the basis for safety (Smallwood, 1996; Behm, 2005; Toole et al, 2006; Gambatese et al, 2008; Larsen and Whyte, 2013). Moreover, often the OHS focus in design and engineering is often on OHS in operations in the finished building whereas the wellbeing of the construction workers in execution is only being slightly considered.

An on-going research project develops and tests a framework to strengthen the inclusion of health and safety considerations in the design phase in construction as a means to achieve a higher level of health and safety in execution. The aim of this research project has been to establish a structured framework to integrate OHS in design and engineering of construction projects. The hypothesis is that health and safety problems in execution can be prevented through efforts in design and engineering in the early stages of the construction processes. This conference paper presents the overall elements in the first part of the research project which is the development of a theoretical framework from a combination of existing literature on health and safety and a mapping of existing practices based on interviews in four companies. The framework couples OHS-risks in construction (health, safety and mental health) to the stages in the design- and engineering processes. The second part of the project is currently testing the framework from interventions on four construction projects followed by an evaluation of the results and processes.

The central actors that the effort is directed toward are the "designers", which covers architects, constructors, engineers and others who carry out their consulting services in the design phase of a construction project. These actors outline the structures of the construction project both in form of the design for the physical structures but also the organisational and strategic structures, the schedule and so forth. Therefore they actually have the opportunity to design and adapt the projects' fundamental structures to protect the construction workers. Hence, it is a different type of questions that can be "asked to" the project material whereas in the later stages of the construction projects it is either only possible to react to the already given structures or make (often expensive) project changes. If demands for OHS are incorporated in the early project design, it becomes easier to organise the construction site in a safe manner.

The paper opens by presenting the methods adopted to design the framework to integrate OHS in design and engineering of construction projects, followed by a literature section and a section on the initial study of current OHS practices in design and engineering on Danish construction projects. The latter two forms the basis of the

design of the framework which is presented in the following section. In the closing section the findings and implications of the approach is discussed and concluded.

METHODS

The research is divided in two coherent stages. The first part of the research project map existing practices and combined with existing literature on occupational health and safety a theoretical framework is developed on how to integrate health and safety considerations in the phases of design and engineering. The methods are primarily qualitative but in the evaluation in the second stage quantitative techniques will also be applied.

The research project uses the work of Jørgensen (2009) as a methodological starting point, which again is based on the lean construction thoughts of Ballard (2000) and Koskela et al. (2002). Jørgensen (2009) developed an initial theoretical framework for integrating OHS considerations in construction design and engineering, which is being further developed in this projects with an expanded understanding of OHS risks and exposures and a more practical take on requirements in the design phases – based on the interviews from stage 1 of the research project.

Empirical setup

Two architectural firms and two consulting engineering firms are project participants. The empirical work in stage 1 included in-depth interviews with 23 architects and engineers conducted at the head offices of the companies. Also thorough discussions were made with a reference group consisting of members from the four companies. The research sought to understand the actual processes of design for safe construction as experienced by the architects and engineers.

These interviews were semi-structured, with an emphasis on facilitating open discussions on the topics. The conversations were steered to make sure that the relevant themes and topics were sufficiently covered.

The second part of the project is ongoing and tests the framework and material through interventions on four to five construction projects followed by an evaluation of the results and processes. This stage is only briefly touched upon in this conference paper. The intervention on the projects consists of workshops, interviews and interactions with participants in design and project planning, mainly architects and engineers. The intervention projects are executed successively through 2014 and the effect of the intervention is evaluated by questionnaires and structured interviews with both architects and consultant engineers but also the contractors are asked to evaluate the project material in relation to OHS; if and how it can be seen to have a higher priority in the projects materials than the usual standard.

SAFETY DESIGN IN CONSTRUCTION

It is widely documented, that the construction industry is risky, both internationally and in Denmark (European Communities, 2004). A number of scholars have determined that safety has root causes in project design. In 1991 a European study found that 60% of accidents could be eliminated or reduced through better design (the European Foundation for the Improvement and Human Rights, 1991). Toole et al., (2006) found that changes in design could reduce 22 % of accidents in construction in the U.S.A. and correspondingly researchers in the UK found that changes in design could reduce 47 % of accidents in construction and that 42% of fatal accidents in

construction could be linked to the safety concept for the building design (Gambatese et al, 2008). Behm found that deficiencies in the design process were the main reason for at least 42 of the 230 examined fatalities in 1990-2003 (Behm, 2005). Scholars have also proved a correlation between project design and accidents in the execution (Gibb et al., 2004; Gambatese et al., 2008).

Ideally the safety of the construction workers in execution should make up an important parameter for designers in the conceptual and preliminary design phases (Szymberski, 1997; Gambatese et al, 2008). The EU directive of 92 (Council Directive 92/57/EEC of 24 June 1992) describes minimum demands for OHS at (temporary) construction locations, and emphasize the role of the building planners (client, architect and consultants) as having the responsible for sketching and outlining a plan for OHS during execution of the construction project. However, in Denmark the directive was not integrated in legislation and deployed until 2008.

Discussions on safety design were pioneered by Perrow (1983) in the production fields and have been a topic since. Ergonomic problems in development of products and processes in the industry has been studied (e.g. Broberg, 2007) as well as activity oriented ergonomic transport (e.g. Lamonde, 1996). Safety design does not simply focus on technical solutions, but also on activities, processes, involvement of users, etc. (Fadier and De la Garza, 2006). Frijters and Swuste (2008) highlights how the knowledge of safety design has not been implemented in the design of most building projects, which is in line with the results of the previously discussed scholars.

The project oriented, dynamic nature of traditional construction can be a barrier to implementing safety but also quality in general into the building process (Loushine et al, 2006; Lingard and Rowlinson, 2005). Also the traditional tendering processes often force a price focus that can compromise or omit a focus on safety (Brooks, 1993). Moreover, traditionally the responsibility to ensure OHS in execution has been that of the contractors (Gambatese and Hinze, 1999; Hinze and Wiegand, 1992) and legislation supports this to some degree. The contractors act as the employers to the construction workers. However, Smallwood (1998) highlights how the client can be the driver to improve the focus and level of OHS (lowering injury rates) on the projects. The client can influence contracts, define the level and focus on OHS and hereby promote OHS considerations to the designers.

A number of scholars describe the amount of influence on safety in the execution phase the designers actually have and how decisions and design in the early phases impact the safety of the construction workers (Hinze and Wiegand, 1992; Gambatese and Hinze, 1999; Thorpe, 2005). Safety design, safety by design or prevention through design in construction is corresponding concepts concerned with how deliberate decisions in the design of the construction project supports safety in execution by removing or reducing OHS risks and exposures to the construction workers' (Behm, 2005; Gambatese and Hinze, 1999; Toole et al, 2006). Safe design can be concentrated purely on technical directions, but often also include a organisational scope e.g. planning methods (Toole et al, 2006; Thorpe, 2005; Frijters and Swuste, 2008). Concrete examples are many, e.g. the Construction Industry Institute (2009) has a catalogue containing over 400 design proposals to design for safety, The Health & Safety Executive's homepage in UK also offers extensive material (HSE, 2009) and in Australia they recommend a special design review form called CHAIR (Workcover, 2001).

THE LEVEL OF OHS IN DESIGN AND ENGINEERING

The study in the first phase of the research project primarily focussed on understanding how OHS is included (or omitted) in traditional design phases in construction. The primary elements studied was 1) the level of knowledge on OHS among the actors in the design phases 2) the designers view on prioritization, duties and responsibilities in connection to OHS in design and 3) how OHS is integrated in current construction design and engineering processes in general.

The findings reveal that the basic knowledge on OHS among non-OHS-professional architects and engineers is limited. In general the actors have no theoretical approach to OHS. Both architects and engineers “know they have to do something”, but they don’t know what that “something” is, how to do it and where to look for information in order to remedy this lack of knowledge. Moreover, the companies often do not have a structured, formal approach to deal with OHS concerns. However, OHS is often relevant to the different disciplines in relation to constructability/buildability, but decisions are then based on traditional practical experiences and not on structured OHS knowledge.

In regard to prioritization, duties and responsibilities the study highlights how the designers broadly do not view it as their responsibility to consider the safety of the construction workers. OHS is considered the contractor's responsibility and competence. This correspond a number of scholars (Hinze and Wiegand, 1992; Gambatese et al, 2008; Toole, 2002). If OHS is formally addressed it is often initiated because of the legal duties and requirements or on specific requested from the client. It is to a large degree considered sufficient to comply with legislation and OHS is rarely prioritized further, although legislation should be seen as a minimum. Also the prioritization is affected by the projects’ overall framework conditions, organization, characteristics, etc.

OHS-activities are often decoupled from the core activities in design and project planning as a retrospective review of the project in the different design phases rather than an integral part of the design work. The participants’ experience, that a strengthened focus on OHS often lead to a better construction process, but only has a small effect on the quality of the product. The study highlights that OHS problems must be addressed very early in the project design; as an explicit part of the formulation of the project goals and values that outlines the priorities in the design processes. The approach must also combine processual elements (a continuous, recurring focus on OHS) and formal gateway reviews/screenings and analysis at the end of every stage in the design process.

The initial study highlights the need to strengthen OHS knowledge and competencies among OHS non-professionals and the demand for a structured and systematic approach to OHS in design and project planning. The investigation further emphasize that to be successful new OHS activities emanating from the research project must be integrated with existing design and engineering practices and parallel to issues such as quality, costs, time, sustainability etc. and not add additional burdens and tasks to the design process.

FRAMEWORK FOR OHS IN DESIGN AND ENGINEERING

The theoretical framework that subsequently was developed couples OHS-risks in construction (safety, health and mental health) to the stages in the design and engineering processes as shown in the figure.

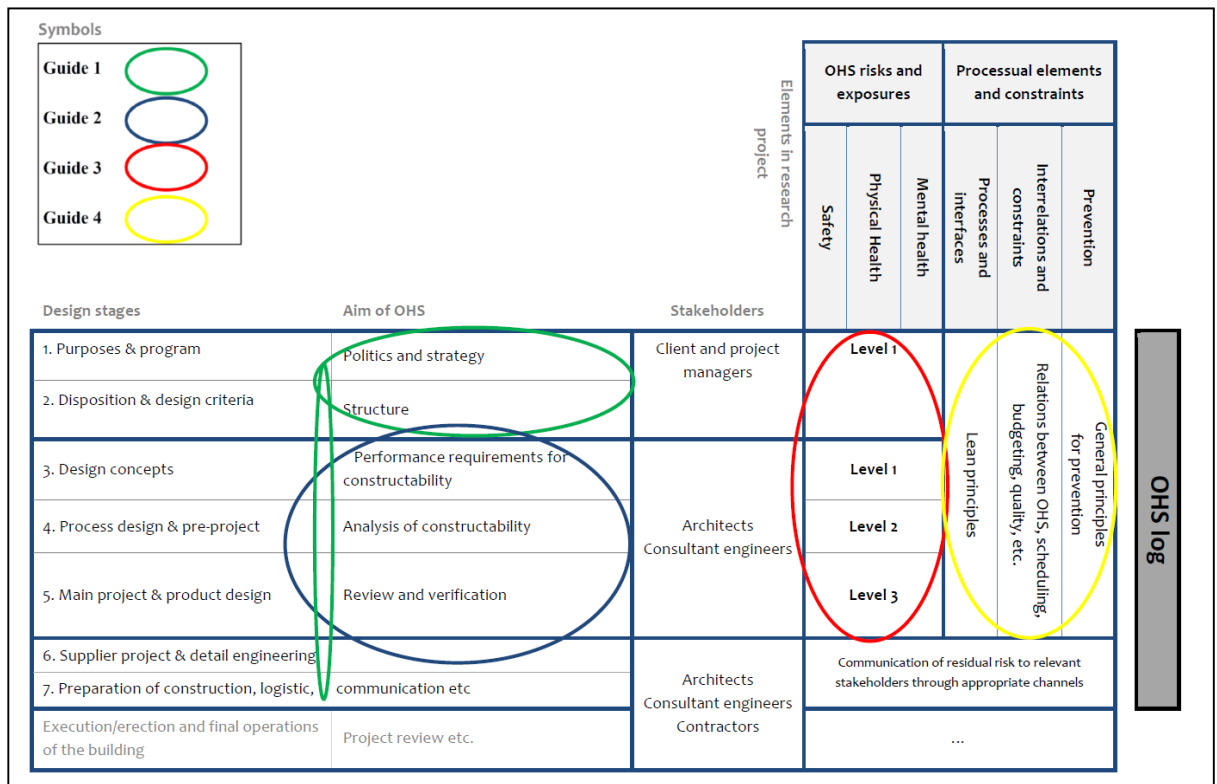

Figure 1: Conceptual framework for integration OHS in design in construction

The vertical axis is divided in seven theoretical design stages derived from Ballard (2000) and Koskela et al. (2002) spanning the timely development of the design of the construction project starting at the initial ideas and ending with the handing over to the contractors. Different contract forms might imply different stage structures.

The aim of the different stages in regards to integrate OHS in design is described in the second column. The third column outlines the normal primary stakeholders/participants of the stages.

An important part of integrating OHS in the design is strengthening the competencies of the participants which are done by presenting the common OHS risks and exposures. The structure on OHS risks is a further development of a structure on common risk to safety in construction (Jørgensen, 2008; 2009; Jørgensen et al., 2010). Based on almost 20.000 hospitalizing working injuries in the Netherlands occupational safety risks has been divided into three levels, which led to four overall groups (level 1), that was divided into 17 subgroups on level 2 and 64 subgroups on level 3 (Jørgensen et al, 2010). This research project has in the same manner divided occupational risks to the physical and mental health into three detail levels from a thorough review of literature, executive orders and regulations from the Danish Working Environment Authority and materials from industry organisation e.g. the Safety Council for the Danish Construction Industry.

To acknowledge that the level of detail in the projects' design is developed through the stages, equivalent the level of detail in the assessment and evaluation of OHS risks and exposures is also developed through the stages. So in the initial stages of the design the OHS risks can be assessed at level 1 (the most general level), in the following stages of design and engineering OHS risks can be assessed at level 2 (adding an extra layer of detail to the assessment) and accordingly in the final stages OHS risk should be assessed at level 3 (the most detailed outline of the risks). An example at level 1 could be the assessment of the surfaces, where people move or work. This category is subdivided on level 2 into the risk of a) falling from heights and b) falling in the same level. A level 3 assessment in the final stages address the specific work processes, e.g. risks from work on mobile scaffolding.

The last three columns denote that the assessment of the OHS risks must also include the interfaces to adjacent parts of the construction structure but also the interfaces to previous and subsequent actors and processes. Hence, the concept includes a theoretical (and practical) understanding of the processes and interfaces. Moreover OHS is often prioritized and/or balanced with decisions related to the budget, the schedule, quality issues, focus on sustainability and so forth. So the framework describes these interrelations and constraints – but also delivers a number of incentives to prioritize OHS in design. The framework also presents the participants to the general prioritized principles for prevention (Jørgensen, 2013):

1. Evaluate the risks.
2. Preventing the risk at the source.
3. Adjust the work to the workers, especially the design of the workplace, the choice of equipment and the working methods. Avoid monotonous work and work in fixed rhythms.
4. Take the technological development into consideration.
5. Substitute dangerous work, substances and equipment with something less dangerous.
6. Make plans for safety and health as a coherent whole, which include technology, work design, working condition, social relation and risk factors in the working environment
7. Make precautions against collectively prevention instead of individual prevention
8. Be sure that all workers have got a proper instruction of safety in their work

Not all risks can be eliminated in the design stages. The residual risks have to be taken care of, so the framework delivers a plan and a strategy to communicate residual risks to relevant stakeholders through appropriate channels e.g. the plan for safety and health before the construction begins.

Finally a tool has been developed to assess, evaluate and address OHS in construction design - entitled the OHS Log. The OHS Log combines the elements presented above in a dynamic and simple tool that helps the participants to assess the probability and impact of an OHS risk in the design phase and systematically address constraints and options for prevention. The tool can be used continuously in the processes by the designers to pin-point their concerns in regards to OHS in the design processes – based on their (new) knowledge on OHS risks on three levels. But the tool can also be used in formal gateway screenings at the end of each stage of the project. The tool is typically administrated by a senior project manager or a safety coordinator.

The figure also presents how the conceptual framework is presented in four guides to the participants at the projects. These guides are presented at repeated workshops with the design group on each construction project and a project oriented assessment of the OHS risks is carried out at the different stages of the intervention projects. Also the framework is further developed and tested from the intervention projects.

Guide 1 is focussed on the early stages but also the transverse and coordinating considerations in the design stages and hence primarily is aimed at the projects managers on different levels. Guide 2 is aimed at the designers and consultant engineers and focuses on the corresponding stages in design. These two guides are supplement with further two guides, Guide 3 and 4, that are explanatory manuals; one elaborating specific OHS-risk and another presenting cases of decisions in design and projects planning with either good or bad impact on execution processes.

DISCUSSIONS AND CONCLUSIONS

It is widely recognised in the construction industry and by scholars, that the amount of injuries and fatalities in construction execution is a comprehensive problem and a number of studies highlights how a substantial part of the causes of the incidents can be related back to the early planning and design process. However, most initiatives to reduce these numbers and improve OHS in construction direct their attention towards the contractors. Thus, this research highlights the importance of implementing OHS considerations in planning and design and contributes with a practical framework and demonstration of how OHS can be integrated in the design of the construction projects and processes, parallel to considerations on budget and scheduled and possibly linked to discussion on quality, constructability, but also to agendas on sustainability etc.

The first stages study confirms that the architects and engineers only have a limited basic knowledge on OHS and that OHS-activities are not prioritized. OHS-activities are decoupled from the core activities in design and project planning. A structured and systematic approach to OHS in design and project planning is requested by the designers. The investigation further highlights that the approach must be integrated with existing design and engineering practices and may not be an additional stand-alone task. In a time with growing requirements on a number of subjects (energy, sustainability, IKT etc.) it is obviously important not to put an extra burden on the designers – and to compromise their mental health.

The integration of an OHS focus in the design phases demands for a comprehensive framework, since there are a lot of constraints to other parts of the processes. However, at the same time it is central, that the use of such an approach is not a burden to the projects participants. The OHS Log in the design phase is a dynamic, simple tool to assess, evaluate and manage OHS risks, and the testing and further development of this could be a vital element in the success of the overall framework. So far the interim testing shows promising results.

It also seems essential that changes to heighten the level of OHS must come both from society/legislation and from inside the companies. Participants in the initial study all referred to legislation as a driver. However, it is relevant to explain the non-OHS-professionals that legislation is only a minimum and to motivate the designers to strive for a higher level of OHS. Another task is to explain the architects and consultant engineers why they should be worried about safety in execution as an effect of their design. There continues to be an expectation that it is the contractor's responsibility –

as long as the designers comply with legislation. Quality and sustainability are popular agendas under which OHS can be cultivated since these subjects are often an important part of the companies' social responsibility agenda to promote themselves in a competitive market. Another incentive to prioritize OHS in design is to visualize the costs of injuries.

The next part of the research project currently tests and evaluate the developed framework through interventions in the design process of a number of construction projects. The research also investigates the effects in execution of the intervention process in design and planning.

REFERENCES

- Ballard, G (2000) "Lean Project Delivery System". White paper No 8, Lean Construction Institute, USA.
- Behm, M (2005) Linking Construction fatalities to the design for construction safety concept. "Safety Science", 43, 589-611.
- Broberg, O (2007) Integrating Ergonomics Into Engineering: Empirical Evidence and Implications for the Ergonomists. "Human Factors and Ergonomics in Manufacturing", 17 (4), 353-366.
- Brook, M (1993) "Estimating and Tendering for Construction Work". Oxford: Butterworth-Heinemann.
- European Communities (2004) "Work and health in the EU – a statistical portrait". Luxembourg: Office for Official Publications of the European Communities.
- European Foundation for the Improvement of Living and Working Conditions (1991) "From Drawing Board to Building Site". Luxembourg: Office for Official Publications of the European Communities.
- Fadier, E and De la Garza, C (2006) Safety design: Towards a new philosophy. "Safety Science", 44, 55-73.
- Frijters, A C P and Swuste, P H J J (2008) Safety assessment in design and preparation phase. "Safety Science", 46, 272-281.
- Gambatese, J A and Hinze, J (1999) Addressing construction worker safety in the design phase – Designing for construction worker safety. "Automation in Construction", 8, 643-649.
- Gambatese, J A, Behm, M and Rajendran, S (2008) Designs role in construction accident causality and prevention: Perspectives from an expert panel. "Safety Science", 46, 675-691.
- Gibb, A, Haslam, R, Hide, S and Gyi, D (2004) The Role of Design in Accident Causality. In: S. Hecker, J. Gambatese and M. Weinstein, (eds) "Designing for Safety and Health in Construction", Eugene, Oregon: University of Oregon Press.
- Hinze, J, and Wiegand, F (1992) Role of Designers in Construction – Worker Safety. "Journal of Construction Engineering and Management", 118 (4).
- Jørgensen, K (2008) Accidents at work and views on Prevention in The Danish Construction Industry. "CLR News", 2, 14-23.
- Jørgensen, K (2009) "Arbejds miljø i byggeriets designfase". Report nr. 7, Kgs. Lyngby: DTU.
- Jørgensen, K (2010) Integration of Safety and Health in the Total Building Delivery System. "CIB 2010 World Congress", 10 -13 May 2010, Salford Quays - United Kingdom.

- Jørgensen, K (2013) Safety design integrated in the building delivery system. "Safety Science Monitor", 17(1).
- Jørgensen, K, Duijm, N J and Troen, H (2010) "Risikovurdering og forebyggelse af arbejdsulykker". Kgs. Lyngby: DTU.
- Koskela, L J, Ballard, G, Howell, G and Tommelein, I (2002) The foundations of lean construction. In: R. Best and G. de Valence (eds.) "Design and Construction: Building in Value". Oxford: Butterworth Heinemann.
- Larsen, G and Whyte, J (2013) Safe construction through design: perspectives from the site team. "Construction Management and Economics", 31(6), 675–690.
- Lamonde, F (1996) Safety improvement in railways: Which criteria for coordination at a distance design? "International Journal of Industrial Ergonomics", 17, 481-497.
- Lingard, H and Rowlinson, S (2005) "Occupational Safety and health in Construction Project Management", London: Spon Press.
- Loushine, T W, Hoonakker, P L T, Carayon, P and Smith, M J (2006) Quality and Safety Management in Construction. "Total Quality Management", 17 (9), 1171-1212.
- Perrow, C (1983) The organizational context of human factors engineering. "Administrative science Quarterly", 28, 521-541.
- Smallwood, J J (1998) Safety and health and the environment as project parameters. Proceedings, "CIB World Building Congress 1998", Gavle, Sweden. 1587-1594.
- Smallwood, J J (1996) The role of project managers in occupational safety and health. Proceedings, "First International Conference of CIB Working Commission W99. Implementation of Safety and Health on Construction sites", Lisbon, Portugal. 227-236.
- Szymberski, R (1997) Construction project safety planning. "TAPPI Journal", 80, 69-74.
- The Construction Industry Institute (2009) "Design for Construction Safety Toolbox". 2nd edition, CII. Retrieved from www.construction-institute.org/scriptcontent/more/rr101_11_more.cfm
- Thope, B (2005) "Safety and health in Construction Design". Gower Publishing Limited, USA.
- Toole, M (2002) A comparison of Site Safety Policies of Construction Industry Trade Groups. "Practice Periodical in Structural Design and Construction", Special Issue: Construction Safety, 7(2), 90–95.
- Toole, M, Hervol, N and Hallowell, M (2006) Designing for Construction Safety. "Modern Steel Construction".
- HSE (2009) Managing health risks in construction. "Health and Safety Executive", UK. Retrieved from www.hse.gov.uk/construction/designers/index.htm
- Workcover, Australia (2001) "Construction Hazard Assessment Implication Review – CHAIR". Retrieved from www.workcover.nsw.gov.au/Publications/OHS/SafetyGuides/chairsafetyindesigntool.htm

INVESTIGATION OF FALL PROTECTION PRACTICES IN THE CONSTRUCTION INDUSTRY OF PAKISTAN

Rafiq M. Choudhry¹, Bilal Tariq² and Hamza F. Gabriel³

²³*Professor of Construction Engineering and Management, Department of Civil and Environmental Engineering, College of Engineering, King Faisal University, Kingdom of Saudi Arabia; Formerly, Professor and Head, Department of Construction Engineering and Management, School of Civil and Environmental Engineering, National University of Sciences and Technology, Islamabad, Pakistan. Tel: +966135895401*

²*MS Student, Department of Construction Engineering and Management, School of Civil and Environmental Engineering, National University of Sciences and Technology, Islamabad, Pakistan.*

³*Associate Professor, Department of Water Resources and Hydraulic Engineering, National University of Sciences and Technology, Islamabad, Pakistan*

The construction industry has witnessed large number of injuries and fatalities, more than any other industrial sector and the construction industry of Pakistan (CI) is experiencing the same phenomenon. It is the most hazardous industry in the country. Most attributed reason for accidents are fall from height. The study is undertaken via a questionnaire based survey to investigate fall protections practices in the construction industry of Pakistan. Input was sought from contractors, consultants and clients. A total of 145 respondents were approached, out of which data were collected from 110 respondents located in different cities in the country, showing a healthy response rate of 75%. Results show that fall protection is far from satisfactory. Major findings included: absence of a national safety regulatory body, lack of emphasis on safety by clients in contractual agreement resulting in no significant budget allocation, unavailability of fall protection equipment, inadequate training to workers in fall protection methods, relaxed attitude by supervisors against non-complying workers, confronting attitude of workers towards adoption of fall protection measures, and lack of penalties levied on contractors not taking action against unsafe work practices at height. The core issues requiring emphasis are: a) special fall safety training sessions for contractors and sub-contractors, b) workers' education in fall hazards they face on-site coupled with appropriate protective measures, c) legal cover to penalize unsafe working on construction sites, and e) reduce cost of import on safety equipment and promote indigenously built safety products. The study recommends promulgating a regulatory body on the lines of OSHA which should cater to national needs of occupational safety and health working in collaboration with Pakistan Engineering Council (PEC), evaluating safety performance, ensuring safety compliance and recording occupational injuries and fatalities occurrence.

Keywords: construction safety, fall protection, occupational injuries, safety training, Pakistan.

²³ rchoudhry@kfu.edu.sa

INTRODUCTION

Construction industry (CI) is one of the most hazardous industries all over the world (Hinze, 1997; Kartam, 1997). Construction labor form 7.5% of the world labor force and contributes to 16.4% of total global occupational accidents (Kulkarni, 2007). Fatalities in CI are 60,000 per annum worldwide (ILO, 2005). Itemization of the fatalities revealed that fall from height is the prevalent source of accidents, accounting for almost 35% of construction worker deaths (ILO, 2005). Various factors contributes to fall incidents like oil, cleaning fluid, water, slippery shoes, poor lighting, and objects projecting into the walkway, uneven walking surface and other slippery substances on the walking surface (Huang and Hinze, 2003).

Construction companies around the globe are implementing safety, health and environmental management systems to reduce injuries, eliminate illness, and to provide a safe work environment for their employees (Choudhry et al., 2008a). The need for further improvement is still there despite the OSHA regulations owing to the unusually high number of injuries. In Pakistan, 'Government of Pakistan labor policy 2010' and 'Factories Act 1934 (chapter 3)' are the main laws governing occupational health and safety (Labor Laws, 2014). It contains special provisions for all occupations to regulate the working conditions but unfortunately their enforcement due to the negligence of Government regulatory authorities remains low. In Pakistan, there is no institution on the lines of OSHA, NIOSH or BLS to effectively cater to the challenges of CI and collect reliable statistical data (Choudhry et al., 2008b). Even the main regulatory body for the CI is Pakistan Engineering Council (PEC), which has yet to lay down safety regulations and laws. Construction has been termed as backward because of its relatively lesser use of modern techniques and tools. In most cases there is no reporting and documenting procedure of accidents.

Construction in developing countries is more labor intensive than that of the developed countries, involving 2.5-10 times as many workers per activity (Koehn and Regmi, 1991). The CI in the country has a share of only 2.3% in GDP yet its share in the employed labor force stands disproportionately large at 6.1% (Khan, 2008, Koehn et al., 1995). Anecdotal evidence indicates that construction worker injuries and fatalities in Pakistan could be as high as 20-25% (Farooqui et al., 2008). Additionally, the framework of occupational health and safety in Pakistan is fragmented and not enforced widely. Mainly laws governing safety are found and referred to the 'Factories Act 1934'. Other documents which contain laws relating to OHS are the Mines Act 1923, Workmen's Compensation Act 1923, Dock Laborer Act 1934, Social Security Ordinance 1965 and Shop and Establishment Ordinance 1969. These laws require revision and updating to current circumstances (Awan, 2001; Ali, T.H., 2006). There is no published data, though; fall accidents are among the highest on construction sites. The questionnaire is to focus on common cites for the occurrence of fall accidents that include off roof; collapse of scaffolding and off scaffolding, through the floor opening, sky-lights, off ladder, through roof opening, off edge of floor opening and off beam support. The paper is recommending that there may be a government body Pakistan Occupational Safety and Health Administration (POSHA) same like OSHA in USA to look after safety issues in the country. The objective of this research is to investigate fall protection practices in the construction industry in Pakistan.

RESEARCH METHODOLOGY

This research is designed to study the prevailing fall protection practices in the CI of the country. To proceed in a systematic way, four distinct phases were focused namely preliminary study, collection of data, analysis of data and fall prevention framework. Questionnaire surveys and interviews were carried out to gauge the prevailing scenarios. At the beginning, a questionnaire was designed. The questionnaire was comprised of 3 main sections containing a total of 20 questions. The sections were named as organization's safety program, accident and site information, and personal opinion on fall protection. The questionnaire was having five-point Likert-type scale to note responses. To check the authenticity of the questionnaire, a pilot survey was conducted. Interviews were also conducted with the management responsible for ensuring construction worker safety on-site. The questionnaires were distributed to 145 potential respondents out of which 110 valid responses were returned for final analysis. These included responses from 25 clients, 41 contractors and 44 consultants. Overall response rate was 75.9%. A 20% response rate is considered satisfactory, whereas, in construction industry, a good response rate is 30% (Black et al. 2000). The response rate in this research was considered acceptable. In the data analysis, statistical package for social sciences (SPSS-18) was used. Data were entered and analyzed to have frequency analysis, reliability analysis and relative importance index (RII) analysis.

There were 110 valid responses out of 145, representing a response rate of 76%. Response by owners was 22.7%, contractors 37.3% and consultants 40%. The respondents were having varied experience in the CI, with 30.0% of the respondents had an accumulated over 10 years of construction experience, 44.6% had construction experience of 6 to 10 years, whereas merely 25.4% had an experience less than 5 years. Respondents were from different professions in the CI, with nearly 36.7% of the respondents were managers, 47.3 % were field engineers, 13.5% were supervisors and 5.5% were workers. For the cost of the projects undertaken, majority of organizations (61.8%) were engaged in executing project amounting to more than Rupees 500 Million.

RESULTS AND ANALYSIS

Analysis of the data indicated that 40.91% respondent had exposure with fall hazards ranging between 15 minutes to an hour. This duration appears to be enough to formulate an effective fall protection policy for implementation. Though, a policy is necessary even with low numbers to place a fall prevention strategy on-site. The next highest percentage of respondents (20.91%) had exposure to fall hazards greater than 4 hours, more than half of a typical working day of 8 hours. Figure 1 indicates that respondents were exposed with fall hazards duration of 2 hours to 4 hours (18.18%), less than 15 min (11.82%) and between 1 to 2 hours (8.18%).

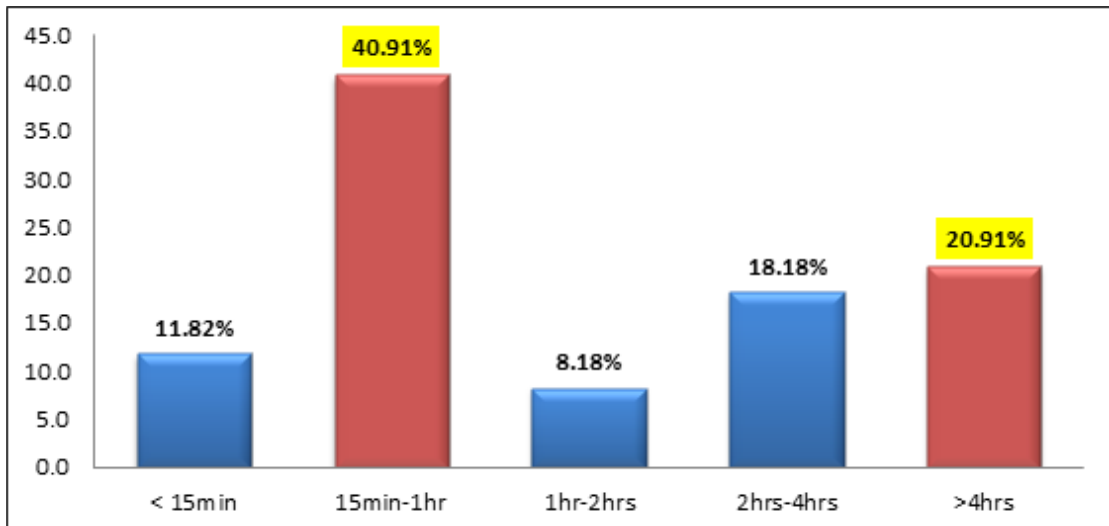

Figure 1: Duration of exposure to fall hazards

Enforcement of fall protection program

Large firms represented a slightly better picture with 28.8% of respondents responding that a written fall protection program was enforced; however, majority of respondents (48.1%) from large firms indicated that there was no fall protection program in the companies. In medium firms only 12.9% of respondents confirmed a written fall protection program was enforced whereas a staggering 64.5% responded that there was no such program enforced. Within the small companies, there is a totally hopeless picture with mere 7.4% of respondents confirmed a written fall protection program was enforced while a clear majority of respondents 88.9% replying in negative. Figure 2 shows comparison of the level of enforcement in the three categories of companies: large, medium and small firms.

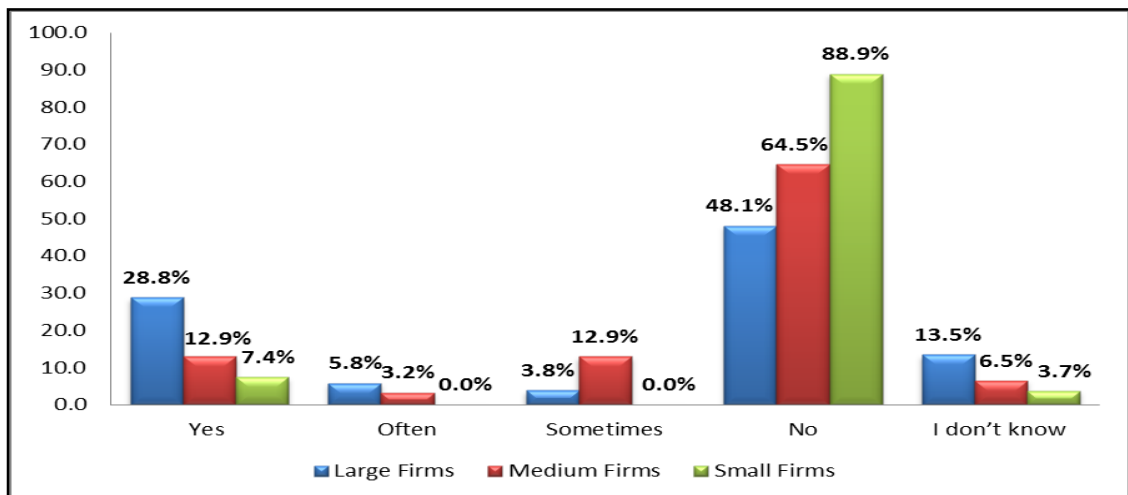

Figure 2: Enforcement of written fall protection program

Practice of fall protection

This section state the status of fall protection systems employed in the surveyed companies and used by the respondents. The most frequently employed system is guardrails, with 45.5% of respondents indicating that it was employed on their construction sites. The second most commonly used system was the warning line with

29.1% indicating that it was employed. The other fall protection systems employed were personal fall arrest system (PFAS) (26.4%), safety nets (5.5%), controlled access zones (CAZ) (24.5%), fall protection plan (18.2%), and safety monitor system (SMS) (13.6%). Safety nets usages were the least and rarely used fall protection system as shown in Figure 3. The companies in the country employed a wide variety of fall protection systems however, their use is not widespread.

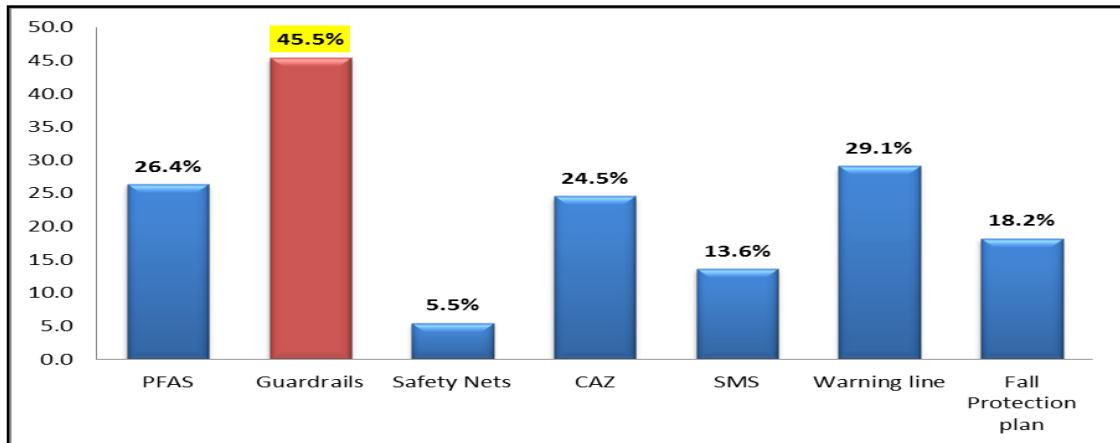

Figure 3: Fall protection systems

Cause of fall accident

Out of the 7 causes of fall accidents, the cause 'off roof' has the highest value of RII (0.6924) whereas 'off edge of floor opening' has the lowest value of RII (0.3258). It implied that the major cause of fall accidents in the CI were workers falling 'off roof' followed by 'falls off ladder' and 'through roof opening', whereas the least cause was falling 'off edge of floor opening'. The respondents were asked to assess the different causes of fall accidents among all types of accidents occurring on the construction sites. A total of 7 causes were provided. Means, percentages, relative importance indexes (RIIs) and ranking of 7 causes were calculated and listed in Table 1.

Table 1: Causes of fall accidents

S. No	Cause of Fall	Mean of Causes	Percentage of Fall relative to mean	RII of Cause of Fall	Overall ranking
1	Off roof	4.15	21.5%	0.6924	1
2	Collapse of scaffolding and off scaffolding	2.33	6.70%	0.3879	6
3	Off beam support	2.05	5.25%	0.3409	4
4	Through floor openings, skylights	2.04	5.24%	0.3394	5
5	Off ladder	3.31	13.1%	0.5515	2
6	Through roof opening	2.84	9.20%	0.4727	3
7	Off edge of floor opening	1.95	4.75%	0.3258	7

Form of fall protection in construction

Respondents were asked about the form of fall protection that was most appropriate or widely used in the construction industry. The questions were asked about truss installation, roof sheathing, and roofing at slopes less than 4:12, between 4:12 and 8:12 and greater than 4:12. Results are shown in Table 2.

Table 2: Overall ranking

S.	Applications (5)	PFAS	Guard rail	Safety net	CAZ	SMS	Warning Line System	Fall Protection Plan	None
1	Truss Installation	55.45% Rank 1	4.55%	13.64% %	0.00%	0.00%	0.00%	23.64% Rank 2	2.73% %
2	Roof Sheathing	35.45% Rank 1	24.55% Rank 2	18.18% %	2.73%	0.00%	0.00%	13.64%	5.45% %
3	Roofing, slope 4:12 or less	2.73%	10.91% %	0.00%	0.00%	11.82% %	28.18% Rank 1	27.27% Rank 2	19.9% %
4	Roofing, slope 4:12 to 8:12	13.64% %	28.18% Rank 1	26.36% Rank 2	23.64% %	0.00%	2.73%	0.00%	5.45% %
5	Roofing slope 8:12 or more	45.45% Rank 1	13.64% %	27.27% Rank 2	2.73%	0.00%	0.00%	10.91%	0.00% %

Personal fall arrest system (55.45%) was felt to be the most appropriate form of fall protection followed by ‘fall protection plan’ (23.64%). For roof sheathing, PFAS (35.45%) and guardrails (24.55%) were preferred. For slopes below 4:12, respondents identified many options whereas the preferred option was ‘warning line system’ (28.18%) followed almost equally by ‘fall protection plan’ (27.27%). A quite significant amount of respondents identify ‘safety monitoring system (11.82%)’. For slopes between 4:12 and 8:12, SMS was no longer cited and the preferred option was guardrail (28.18%) and Safety net (26.36%). For slopes above 8:12 Warning Line System and SMS were no longer preferred by the respondents, and the major method of protecting workers comes out to be PFAS (45.45%).

Problems encountered with compliance

The respondents were asked to comparatively rank common problems associated with implementation of fall protection. Results are tabulated in Table 3. The most significant problem, mentioned by 80.36% of respondents, was the ‘inadequate availability of fall protection on site’, followed by ‘inadequate training regarding proper use of fall protection equipment’ cited by 74.77% of respondents. Other problems reported by the respondents were ‘decrease in productivity’, ‘unavailability of anchorage point’ showing lack of incorporation of safety aspects in the design process. Slip and trip problems can be effectively dealt through providence of adequate training.

Table 3: Problems of fall protection

S. No	Problems (5)	Mean	Percentage	RII	Overall Ranking
1	Suitable anchorage point unavailable	2.59	51.89%	0.5164	4
2	Inadequate availability of fall protection equipment	4.02	80.36%	0.8018	<u>1</u>
3	Decrease in productivity by increase in time required for task completion	2.77	55.32%	0.5527	3
4	Inadequate training regarding proper use of fall protection equipment	3.74	74.77%	0.7527	<u>2</u>
5	Use of fall protection in itself creating more hazard	1.88	37.66%	0.3764	5

Worker behavior

The respondents were asked about reasons behind the workers' behavior. It appeared that worker behavior was the primary source of non-compliance. It was established why workers would or would not comply to fall protection. The results are tabulated in Table 4. The primary reason for the compliance of workers cited was 'employer's requirement'. It is the principal motivator for safe worker behavior. Next reason was 'worker's own concern for his security and safety' followed by 'supervisor's enforcement'. Fellow safety-conscious worker's pressure comes last and was least cited.

Table 4: Reasons for worker compliance

S. No	Reasons	Mean	Percentage	RII	Overall Ranking
1	Personal security and safety	2.85	71.6%	0.7159	2
2	Employer's requirement	3.04	75.7%	0.7568	1
3	Supervisor's enforcement	2.85	71.1%	0.7114	3
4	Fellow safety-conscious worker's pressure	1.27	31.6%	0.3159	4

The primary reason for non-compliance was again management-centered, with 90.8% responding that fall protection 'not a compulsory requirement by employer' was the major reason for non-compliance. Employers usually shy away from making it compulsory as it demand extra cost for such measures. Other reasons with fall protection were uncomfortable (62.3%), and 'slowing down and affecting productivity' (60.2%), 'lack of enforcement by supervisors' (58.3%) giving them chance to avoid using fall protection. All these results are tabulated in Table 5.

Table 5: Reasons for worker non-compliance

S. No	Reasons	Mean	Percentage	RII	Overall Ranking
1	Believing that fall will not occur	3.03	50.5%	0.5045	5
2	Not a compulsory requirement by employer	5.45	90.8%	0.9076	1
3	Uncomfortable	3.74	62.3%	0.6227	2
4	Slowing down and affecting productivity	3.61	60.2%	0.6015	3
5	Not enforced by supervisor	3.50	58.3%	0.5833	4
6	Pressure from fellow workers to not use fall protection	1.68	28.0%	0.2803	6

Actions to increase worker protection

The final question asked dealt with analyzing the appropriate and possible actions that may lead to increase in worker protection. The respondents were asked whether they feel the possible actions as proposed would encourage or discourage compliance to fall regulations. The responses were assessed based upon Likert scale, with 'strongly encourage' given the maximum score and 'strongly discourage' getting the least score. Remaining options were scored relatively. The means and RII were then calculated for each mentioned action as shown in Table 6.

Table 6: Actions to increase worker protection

S. No	Proposed Actions (7)	Mean	Percentage	RII	Overall Ranking
1	Promulgation of safety body POSHA on the model of OSHA in Pakistan	4.54	90.7%	0.9073	1
2	Harsher regulations, enforcement, inspection	4.17	83.5%	0.8345	4
3	Safety evaluation of a company during bidding process	4.45	88.9%	0.8891	3
4	Increased training for workers in proper fall protection methods	4.51	90.2%	0.9018	2
5	Lowering or subsidizing the cost of fall protection equipment	3.57	71.5%	0.7145	6
6	More cooperation with safety consultants	3.44	68.7%	0.6873	7
7	Innovative methods of fall protection which are less restrictive	4.05	81.1%	0.8109	5

The primary issue relating to usage of fall protection was termed as management-oriented. The respondents feel that primarily workers comply to fall protection due to the fact that it is employer's requirement. The respondents felt that the second reason for compliance was the fact that workers show concern for their own personal security and safety. On the other hand, reasons for non-compliance were due to the worker's perception that the fall protection was a hindrance in their work with it being uncomfortable and slowing down and affecting productivity. The professionals felt that the most important action to that needs to be taken to enhance fall protection is to form a regulatory body on the lines of OSHA which should cater to national needs. Absence of such institution results in all other steps to be lack in implementation and monitoring. Increasing worker training to improve worker protection was also felt as an important action. Various other alternative actions were ranked by the respondents, signifying that problems with the current state of fall protection were multi-faceted, which involve all parties in construction. A broad-based strategy and approach is required to address problems faced by workers and contractors.

CONCLUSIONS

Falls remained a serious issue on a construction site concerning all the involved parties. Protection of workers from fall hazards has been termed as vital. Workers themselves show concern that a form of fall protection system was needed while working at height especially on slopes. The present state of compliance towards fall protection measure was found as absent or negligible. Visual inspection of sites showed it to be poor and unsatisfactory. Some high rise buildings involving private entities showed interest towards ensuring safety on site whereas small scale projects showed little concerns. Whereas, projects were found to be lagging far behind in ensuring safety on-site, reasons being lack of knowledge and interest by the organizations and the absence of proper mechanism that can ensure the contractor for a reward in case of ensuring safety. Contractors were hesitant to comply with safety regulations on their own without the interest and involvement of client as safety was sometimes considered a burden on their profit margin.

Lack of knowledge and understanding of both contractors and workers towards fall protection methods was considered a problem. Present methodology towards fall protection needs to be refined and a hierarchal approach needs to be introduced. It can first start with i) emphasis being on elimination of fall hazards followed by ii) preventing fall from occurrence and then iii) arresting the fall in case prevention is not

possible and iv) emergency plan if a fall occurs. Posting warning signs at relevant places is to be ensured all the times. The characteristics which ideal fall protection method is to possess were being simple, feasible, flexible, passive, simple and protective. In reality no single method has been found to possess all these characteristics applicable in every situation. Thus, the method which comes closest to meeting all these characteristics is to be preferred. Further steps needed and considered important by the respondents working in the CI were as follows:

- Increasing the level of contractor and worker training.
- Removing import duties on safety equipment and subsidizing the cost.
- Forming a regulatory body like OSHA.
- Changing the safety culture in construction industry.
- Hardening enforcement and inspection level.
- Promoting safety

REFERENCES

- Ali, T. H. (2006) *“Influence of National Culture on Construction Safety Climate in Pakistan”* PhD Dissertation. Griffith University, Gold Coast, Queensland, Australia.
- Awan, T. (2001) *“Occupational Safety and Safety in Pakistan”*. Asia Labor Update Report No. 39.
- Black, C., Akintoye, A., and Fitzgerald, E. (2000) An analysis of success factors and benefits of partnering in construction. *“International Journal of Project Management”*, 18(6), 423-434.
- Choudhry, R. M., Fang, D. P. and Ahmed, S. M. (2008a) Safety management in construction: Best practices in Hong Kong. *“Journal of Professional Issues in Engineering Education & Practices”*, 134(1), 20-32.
- Choudhry, R. M., Fang, D. P. and Rowlinson, S. (2008b) Challenging and Enforcing Safety Management in Developing Countries: A Strategy. *“The International Journal of Construction Management”*, 8(1), 87-101.
- Farooqui, R. U., Arif, F., and Rafeeqi, S. F. A. (2008) Safety performance in construction industry of Pakistan. In: *“First International Conference on Construction in Developing Countries (ICCIDC-I), Advancing and Integrating Construction Education, Research and Practice”* 4-5 Aug 2008, NED University of Engineering and Technology, Karachi, Pakistan, 74-87.
- Hinze, J. W. (1997) *“Construction Safety”*. Prentice-Hall, Inc.
- Huang, X and Hinze, J (2003) Analysis of construction worker fall accidents. *“Journal of Construction Engineering and Management”*, 129 (3), 262-271.
- International Labor Organization (ILO). (2005) *“Facts on Safety at Work”*. ILO, Switzerland.
- Kartam, N.A. (1997) Integrating health and safety performance into construction CPM. *“Journal of Construction Engineering and Management”*, 123(2), 121-126.
- Khan, R.A. (2008) Role of Construction Sector in Economic Growth: Empirical Evidence from Pakistan Economy. In: *“First International Conference in Developing Countries (ICCIDC-I), Advancing and Integrating Construction Education, Research and Practice”*. 4-5 Aug 2008, NED University of Engineering and Technology, Karachi, Pakistan, 279-290.
- Koehn, E., Kothari, R. K., and Pan, C.S. (1995) Safety in developing countries: Professional and bureaucratic problems. *“Journal of Construction Engineering and Management”*, 121(3), 261-265.

Koehn, E., and Regmi, D. C. (1991) Labor cost calculations in international construction. "AACE Transactions".

Kulkarni, G.K. (2007) Construction industry: more needs to be done. "Indian Journal of Occupational and Environment Management", 11(1), 1-2.

Labor Laws in Pakistan. <http://www.labourunity.org/labourlaws.htm> Accessed on Jan 12, 2014.

Occupational health and ergonomic

COMPARATIVE ERGONOMIC ASSESSMENT OF SLAB FORMWORK SYSTEMS

Dieter Schlagbauer²⁴ and Detlef Heck²⁵

¹⁻²Graz University of Technology, Institute for Construction Management and Economics

The economic efficiency of formwork systems depend not only on the cost of the product, also the achievable performance on the construction site has a big influence on the selection process. This performance is connected to various factors, such as the number or weight of the individual items or the required height of the formwork surface.

In the course of the research project an investigation of four different slab formwork systems performing similar jobs was executed, which enabled a comparison based on an ergonomic assessment

The evaluation of the different systems proved showed that the results and expectation correspond to the expectations, in case the tasks were reviewed separately for the individual systems. Comparing the systems directly by using the calculated points of the ergonomics evaluation for an average work process the results display show that the least onerous system achieved the highest individual score values.

These results lead to the assumption that not only the ergonomic scores should not be the sole base for a decision; therefore the performance progress was included and relative ergonomic values for a typical formwork surface were calculated. The result of this evaluation backs in line with expectations for the strain of the individual systems.

The different results between single-task and performance-related evaluation illustrated showed that for the assessment of health and safety issues combined with economic factors not only the single-task evaluation is important, but rather but also an overall view should be performed for a typical scope of work.

Keywords: slab formwork, ergonomics, workload.

INTRODUCTION

In the construction industry economic efficiency is the most common used criteria when decisions for of applying a specific material or equipment are made, due to the fact that for all companies low costs are usually the only decision tool to acquire a project. Based on national and European Programs (European Agency for Safety and Health at Work, 2004) the focus on Occupational Health and Safety was boosted over the last years. Therefore, also in the construction industry the focus was laid on the health of workers and with this change of mind the duties of the construction supply industry also turned to a more prevention based equipment design.

A major part of the supply for construction companies is provided by formwork companies who rent their systems to the companies and also provide their knowledge in the planning process prior the construction phase. Since reinforced concrete

²⁴ dieter.schlagbauer@tugraz.at

²⁵ detlef.heck@tugraz.at

construction is a main part of civil engineering health and safety programs within this field are often initiated by the formwork companies since they design the shape of a new building and the supporting construction within the current safety regulations.

RESEARCH PROJECT AND GOALS

In 2012 a research project was established in order to evaluate the stress and strain of construction workers while using different slab formwork systems.

The goal was to evaluate the load of the different slab formwork systems directly on the construction site using different analytical methods. The four investigated Systems are “Table formwork system”, “Timber-beam floor formwork system” and two “Panel floor formwork systems”. Based on this evaluation the future workload using one of these systems can be estimated within a closer range than at the present time; therefore, the results of the investigation can be integrated in the decision making process, but this is the smaller part of the investigation outcome. The main part is to implement the results by formwork companies into their product development. The changes of safety regulations, especially in European countries, over the last years made the use of some formwork systems less economic or even impossible. Using the research data the development process of slab formwork systems receives new stimulation from economic and ergonomic point of view.

Method

The assessment of the slab formwork systems within the research project was executed under scientific supervision by using different investigation methods which were applied in research projects before.

The research investigations started on site in order to gain the basic data within four steps:

First, the processes were investigated using a modified REFA method (Schlagbauer et al., 2011 in order to divide the investigated task into "activities" and "interruptions". Then the “activities” were subdivided into different subtasks; subsequently they were classified and evaluated in terms of proportion at the overall performance progress.

Second, the execution of the task was recorded parallel by camera for later analysis of specific tasks with the ergonomic assessment tools.

Third, the achieved performance progress for a given period or amount of time (e.g. the period between to breaks or one room) was recorded during the observation days in order to include the economic evaluation into the results, since the economic efficiency still is the most important variable.

Fourth, for the evaluation of the stress and strain heart rate monitoring onsite and corresponding laboratory test were executed and the data was integrated into the data pool (Schlagbauer et al. 2012).

After the onsite observation the final examination of the data was the ergonomic evaluation of the most frequent occurring activities using two different tools. These tools were modified versions of the “Automotiv Assembly Worksheet” (AAWS)(Schaub 2004) and the “Leitmerkmalmethode” (LLM)(Wichtl 2007 and 2010).

The AAWS method was especially designed for the automotive industry but seemed to fit also for the ergonomic evaluation in the construction industry. In the last years

the AAWS method was improved and turned into the European Assembly Worksheet (EAWS) (Schaub et al. 2014) and this evolution shows that this ergonomic evaluation method is the right assessment tool for the ergonomic evaluation of construction work tasks.

The LLM method contains different evaluation tools for different types of ergonomic load (e.g.: carrying, lifting). These single systems can therefore be used only for specific tasks but not in order to investigate the whole process; only by combining these different tools a broad result can be generated.

The difference between the systems is the effort carried out to get to equal results with different investigators. Here, the LLM with its differentiated views and easy recordable data has benefits. But with trained investigators also the AAWS method can be used and carry out stable results even if different people perform the investigation. Within this paper only the results of the AAWS analysis are presented.

The results of the ergonomic evaluation are points for all investigated activity tasks. These points were combined with the allocation of tasks to overall points for each slab formwork system.

After comparing the points as an absolute number relative values were also calculated for an improved comparison of the different systems.

Data analysis

Performing the data analysis for the four different systems the results of the task distribution, the according points for each investigated task and the overall points for each system are displayed in the following tables.

The first column indicates if the tasks were ergonomically investigated or not, due to different reasons; the second column presents the different task groups and the third shows the investigated tasks within each group. The fourth column shows the mean ergonomic value of each task, based on at least 15 single ergonomic assessments of a task using the AAWS method. Column 5 shows the allocation of each task at the complete investigation period. Columns 6 and 7 provide the system related ergonomic value of each task and of the whole group. The task value is calculated by multiplying the allocation by the mean ergonomic value of the task. In the last column the total ergonomic value of the system is presented.

For the main tasks, which were divided into task groups, the ergonomic evaluation could be performed in nearly all cases. Only for a few tasks ergonomic values have to be taken from cross system evaluation, which was possible due to the similarity of the tasks in all systems.

The “ergonomic not investigated tasks” contain tasks outside the scope of formwork (e.g.: concreting work), breaks, interruptions of the workflow and also three other parts: (1) Additional ergonomic non relevant tasks: this tasks are in no connection to the formwork system and were therefore not investigated; (2) Not identified tasks: in all observations there was a small number of tasks which could not be noticed because the worker was out of sight and therefore no ergonomic value could be evaluated; (3) Ergonomic not clear identifiable tasks: this is a combination of a lot of tasks for which the video sequences showed less numbers for a stable evaluation.

Table 1: Ergonomic analysis of Timber-Beam floor formwork system

	Task Group	Task	Mean ergonomic value	Allocation	System related ergonomic value		Total ergonomic value
					of task	of group	
Ergonomic investigated tasks	G1: Floor props	Assembly of floor props	76,0	1,8%	1,35	2,17	25,96
		Disassembly of floor props	*	0,1%	0		
		Assembly of Removable folding tripods	40,7	1,0%	0,41		
		Assembly of Lowering heads	94,0	0,4%	0,42		
	G2: Fitting surface	Assembly of fitting surface	89,0	2,1%	1,87	3,00	
		Disassembly of fitting surface	110,0 **	0,0%	0,00		
		Preparation of fitting surface	42,5	2,7%	1,13		
	G3: Floor end-shutter system	Assembly of floor end-shutter system	78,2	4,4%	3,46	5,67	
		Disassembly of floor end-shutter system	110,0 **	0,0%	0,00		
		Preparation of floor end-shutter system	42,5	5,2%	2,21		
	G4: Formwork panel	Assembly of formwork panel	71,7	3,6%	2,58	2,58	
	G5: Beams	Assembly of primary beams	88,2	2,0%	1,76	5,93	
		Assembly of secondary beams	85,6	4,9%	4,17		
		Disassembly of primary beams	*	0,1%	0		
		Disassembly of secondary beams	*	0,0%	0		
	G6: Preparation and finishing work	Floor prop transport by hand	53,1	3,3%	1,76	6,61	
		Formwork panel transport by hand	38,3	3,3%	1,27		
		Beam Transport by hand	32,3	3,3%	1,07		
		Equipment transport by hand	8,2	2,5%	0,21		
		Cleaning of formwork panels	17,5	0,2%	0,04		
Clearance of work place		35,9	0,7%	0,24			
Preparation work at stock ground		36,0	2,1%	0,76			
Adjusting formwork panels		90,0	0,7%	0,60			
Drilling work		18,0	0,0%	0,00			
Measurments		9,7	6,0%	0,58			
On hook/ off hook of equipment for crane transport		6,0	1,4%	0,09			
Ergonomic not investigated tasks		Concreting tasks			6,2%		
	Additional ergonomic non relevant tasks			15,7%			
	Interruption of workflow			1,22%			
	Individual break			1,55%			
	Recreation break			12,62%			
	Not identified			0,11%			
	Ergonomic not clear identifiable tasks			10,77%			

* No ergonomic value measured because of low number of task to analyse

** Ergonomic value from different formworks system with comparable task

Table 2: Ergonomic analysis of Table formwork system

	Task Group	Task	Mean ergonomic value	Allocation	System related ergonomic value		Total ergonomic value
					of task	of group	
Ergonomic investigated tasks	G1: Floor props	Assembly of floor props	76	0,60%	0,50	0,80	31,7
		Disassembly of floor props	*	0,30%	0,00		
		Assembly of Removable folding tripods	43	0,70%	0,30		
	G2: Fitting surface	Assembly of fitting surface	89	4,10%	3,60	12,70	
		Disassembly of fitting surface	110**	1,80%	2,00		
		Preparation of fitting surface	43	5,30%	2,30		
		Assembly of formwork panel strip	128	2,70%	3,50		
		Disassembly of formwork panel strip	110**	1,20%	1,30		
	G3: Floor end-shutter system	Assembly of floor end-shutter system	78	1,20%	0,90	2,00	
		Disassembly of floor end-shutter system	110**	0,50%	0,60		
		Preparation of floor end-shutter system	43	1,10%	0,50		
	G4: Table	Assembly of table	35	4,90%	1,70	5,00	
		Lowering table	*	0,70%	0,00		
		Prefabrication of table	106	0,30%	0,30		
		Mounting props to table	62	2,70%	1,70		
	G5: Beams	Assembly of insertion beam	103	3,80%	3,90	4,50	
		Deassembly of insertion beam	90	0,70%	0,60		
	G6: Preparation and finishing work	Floor prop transport by hand	53	2,80%	1,50	6,80	
		Formwork panel transport by hand	38	2,00%	0,80		
		Beam Transport by hand	32	2,00%	0,60		
		Equipment transport by hand	8	1,30%	0,10		
		Cleaning of formwork panels	18	1,10%	0,20		
		Clearance of work place	36	8,00%	2,90		
Preparation work at stock ground		36	0,00%	0,00			
Transport of table by cart		3	0,80%	0,00			
Transport of table by crane		*	1,70%	0,00			
On hook/ of hook of transport fork		31	1,00%	0,30			
Measurments		10	3,20%	0,30			
On hook/ off hook of equipment for crane transport		6	0,70%	0,00			
Ergonomic not investigated tasks	Concreting tasks			5,10%			
	Additional ergonomic non relevant tasks			5,80%			
	Interruption of workflow			3,00%			
	Individual break			2,20%			
	Recreation break			12,40%			
	Not identified			8,40%			
	Ergonomic not clear identifiable tasks			2,90%			

* No ergonomic value measured because of low number of task to analyse

** Ergonomic value from different formworks system with comparable task

Table 3: Ergonomic analysis of Element floor formwork system 1

	Task Group	Task	Mean ergonomic value	Allocation	System related ergonomic value		Total ergonomic value
					of task	of group	
Ergonomic investigated tasks	G1: Floor props	Lowering of floor props	20,8	3,5%	0,70	4,70	30,90
		Assembly of Removable folding tripods	44,0	0,8%	0,40		
		Placing floor props	47,8	2,2%	1,00		
		Assembly of floor props	76,0	3,4%	2,60		
	G2: Fitting surface	Disassembly of fitting surface	133,3	1,5%	2,00	2,00	
	G3: Floor end-shutter system	Assembly of floor end-shutter system	*	1,3%	0,00	0,00	
	G4: Formwork panel	Raising the formwork panel with tool	117,4	1,3%	1,50	9,60	
		Disassembly of formwork panel	140,7	2,1%	2,90		
		Lowering the formwork panel	119,4	3,1%	3,70		
		Hanging the formwork panel	70,0	0,8%	0,60		
		Raising the formwork panel	110,6	0,8%	0,90		
	G5: Beams	Disassembly of additional beams	95,7	2,4%	2,30	2,30	
		Assembly of additional beams	*	0,1%	0,00		
	G6: Preparation and finishing work	Transport of formwork and beams	53,1	8,5%	4,50	12,30	
		Dismantling of formwork	154,0	3,0%	4,70		
		Carrying formwork panels	48,5	3,5%	1,70		
		Carrying floor props	34,9	3,3%	1,20		
		Cleaning of formwork panels	17,5	0,7%	0,10		
		Measurments	9,7	0,2%	0,00		
		On hook/ off hook of equipment for crane transport	6,0	3,0%	0,20		
Ergonomic not investigated tasks	Additional ergonomic non relevant tasks			26,9%			
	Interruption of workflow			1,56%			
	Individual break			6,73%			
	Recreation break			13,37%			
	Not identified			1,46%			
	Ergonomic not clear identifiable tasks			4,57%			

* No ergonomic value measured because of low number of task to analyse

** Ergonomic value from different formworks system with comparable task

Table 4: Ergonomic analysis of Element floor formwork system 2

	Task Group	Task	Mean ergonomic value	Allocation	System related ergonomic value	Total ergonomic value
			of task			of group
Ergonomic investigated tasks	G1: Floor props	Assembly of floor props	60,4	2,6%	1,6	2,3
		Disassembly of floor props	49,0	0,6%	0,3	
		Assembly of Removable folding tripods	40,7	0,5%	0,2	
		Assembly of Lowering heads	94,0	0,3%	0,3	
	G2: Fitting surface	Assembly of fitting surface	89,0	3,4%	3,0	5,5
		Disassembly of fitting surface	110,0**	0,6%	0,7	
		Preparation of fitting surface	42,5	4,3%	1,8	
	G3: Floor end-shutter system	Assembly of floor end-shutter system	78,2	3,4%	2,7	3,9
		Disassembly of floor end-shutter system	110,0**	0,4%	0,4	
		Preparation of floor end-shutter system	42,5	2,0%	0,9	
	G4: Formwork panel	Placing formwork panel from above	37,9	1,0%	0,4	3,4
		Placing formwork panel from below	117,7	1,0%	1,2	
		Disassembly of formwork panel	137,0	1,1%	1,5	
		Assembly of insertion rail	52,7	0,6%	0,3	
	G5: Beams	Assembly of beams	63,2	1,4%	0,9	1,3
		Disassembly of beams	92,3	0,5%	0,5	
	G6: Preparation and finishing work	Carrying floor props	53,1	2,6%	1,4	11,1
		Carrying formwork panels	65,1	3,7%	2,4	
		Carrying beams	32,3	2,0%	0,6	
		Equipment transport by hand	8,2	1,0%	0,1	
Cleaning of formwork panels		17,5	0,4%	0,1		
Clearance of work place		35,9	0,7%	0,3		
Preparation work at stock ground		36,0	14,6%	5,3		
Adjusting formwork panels overhead		90,0	0,7%	0,6		
Drilling work		18,0	0,1%	0,0		
Measurments		9,7	2,6%	0,3		
On hook/ off hook of equipment for crane transport		6,0	1,4%	0,1		
Ergonomic not investigated tasks	Concreting tasks			2,9%	0,0	0,0
	Reinforcement tasks			0,6%	0,0	
	Additional ergonomic non relevant tasks			13,9%	0,0	
	Interruption of workflow			0,30%	0,0	
	Individual break			8,60%	0,0	
	Recreation break			12,60%	0,0	
	Not identified			1,30%	0,0	
	Ergonomic not clear identifiable tasks			6,30%	0,0	
27,6						

* No ergonomic value measured because of low number of task to analyse

** Ergonomic value from different formworks system with comparable task

RESULTS

Ergonomic results

The individual analysis shows the ranking of the different formwork systems according to the ergonomic points (a lower point value means less ergonomic strain for workers): 1.) “Timber-beam floor formwork system” 25,96 points, 2.) “Element floor formwork system 2” 27,62 points. 3.) “Element floor formwork system 1” 30,86 points, 4. “Table formwork system” 31,66 points.

These results are rather surprising, since the “Table system” is usually named the system with the lowest strain for construction workers. However this outcome can be explained by two following influence factors. First, the special arrangement at the investigated construction site: using the table system, there usually is only one assembly time, but at the investigated site, the construction workers had to assembly and disassembly the tables for every storey because of the limited storage space. Second, the level of possible performance with the table system: it is usually higher than at all other systems and therefore the ergonomic points per m² will show a different result.

Performance results

The other important data, besides the economic evaluation were performance data sets of the different systems, as shown in the following table.

Table 5: Comparison of the performance of the different formwork systems investigated and based on literature

Formwort system	Performance value [m ² /h]		
	Investigated	Literature	Difference
Timber-beam floor formwork system	13,52	13,89	-0,27
Table formwork system	23,85	29,41	-5,56
Element floor formwork system 1	14,89	*	
Element floor formwork system 2	10,67	15,15	-4,48

* Newly invented formwork system, no literature data available

Using the investigated performance data and the ergonomic load combined another ranking can be created. For an easier comparison of the results a comparative area - in this case a usual slab formwork area which is set up at once - of 500m² is taken as base and the ergonomic points for setting up this area are calculated (a lower point value means less ergonomic strain for workers).

Table 6: Comparison of the ergonomic points for an area of 500 m²

Rank	Formwork system	Duration of execution	Total ergonomic points
4	Timber-beam floor formwork system	61,67 h	56,5 (= 61,67/28,33)*25,96
2	Table formwork system	35,00 h	39,1 (= 35,00/28,33)*31,66
1	Element floor formwork system 1	28,33 h	30,9
3	Element floor formwork system 2	55,00 h	53,6 (=55,00/28,33)*27,62)

As in table 5 presented, the ranking of the formwork systems changed upside down and now the “Timber-beam floor formwork system” is the most straining system.

CONCLUSIONS

Based on the findings within the research project, the use of the AAWS method for the ergonomic evaluation of construction work tasks is possible. But since this tool was not originally designed for the construction industry the AAWS method should be adapted for a better fit when used for typical tasks in construction.

The results show that each system provides tasks that lead to very high ergonomic point levels and should be reduced by product developments or the redesign of system parts. This implementation of ergonomic knowledge based on the onsite observations into the product development process could lead to an improvement of the work place conditions and a higher output performance, which would lead to increased revenues for the companies.

The final results in table 5 display the expected ranking of the ergonomic load for the different systems and the comparison between table 4 and 5 show the change in the ranking between absolute and relative points. This leads to the conclusion that an overall review is necessary besides the specific look at single tasks when planning or evaluating construction work tasks.

For example, if only the relative points would have been taken into account the “Table system” with a high performance wouldn’t have been chosen because of the high ergonomic load. Otherwise, if the performance had been the only factor the “Element floor formwork system” would not have been chosen because of the lower economic revenue which could be gained. These two aspects represent the different points of view; the view of a company leader who usually wants the most revenue out of his investment and from a health and safety advisor for whom the impact on the construction worker is in the main topic. Therefore, the product development has to consider both sides and future research projects should also be set up open minded and with the focus on not only one single issue.

REFERENCES

- European Agency for Safety and Health at Work: SYSTEMS AND PROGRAMMES - Achieving better safety and health in construction; Information report, 2004.
- Schaub, K.: Das „Automotive Assembly Worksheet“ (AAWS); in: Montageprozesse gestalten: Fallbeispiele aus Ergonomie und Organisation; Ed.: Landau, K.: Stuttgart. ergonomia, 2004.
- Schaub et al., The European Assembly Worksheet; in: Theoretical Issues in Ergonomics Science, 2013, P.: 616-639.
- Schlagbauer et al.: Interdisciplinary Research Project: Principles of Work Scheduling; in: Modern Methods and Advances in Structural Engineering and Construction, 2011, P.: 117 - 122
- Schlagbauer et al.: Integration of Sports Scientific Knowledge in the Scheduling of Construction Projects; in: Research to Practice, 2012.
- Wichtl, M.: Heben und Tragen von Lasten; in: AUVA Forum Prävention 2007, 2007.
- Wichtl, M.: Physische Belastungen - Manuelle Lasthandhabung; in: AUVA Forum Prävention 2010, 2010.

INSULATION OF TRADITIONAL INDIAN CLOTHING: ESTIMATION OF CLIMATE CHANGE IMPACT ON PRODUCTIVITY FROM PHS (PREDICTED HEAT STRAIN) MODEL

**Kalev Kuklane²⁶, Karin Lundgren¹ Tord Kjellstrom², Vidhya Venugopal³,
Jintu Fan⁴ and George Havenith⁵**

¹ *Thermal Environment Laboratory, Division of ergonomics and Aerosol Technology, Department of Design Sciences, Lund University, Lund, Sweden*

² *Health and Environment International Trust, Mapua, New Zealand*

³ *Department of Environmental Health Engineering, Sri Ramachandra University, Chennai, India*

⁴ *Department of Fiber Science & Apparel Design, College of Human Ecology, Cornell University, Ithaca, New York, USA*

⁵ *Environmental Ergonomics Research Centre, Loughborough University, Loughborough, United Kingdom*

Major databases on western clothing and their thermal properties are available, but information on non-western clothing is lacking. A recent ASHRAE project 1504-TRP, Extension of the Clothing Insulation Database for Standard 55 and ISO 7730 dealt with the issue. Simultaneously, a co-operation study at Indian workplaces allowed us to acquire some sets of the traditional clothes used at construction sites in Chennai area. The work was related to mapping of present work conditions in order to allow predictions and measures to be taken if the mean temperature of the work environment would rise. We selected ISO 7933 on predicted heat strain (PHS) as a tool to estimate productivity loss in physical work. PHS criteria are related to reaching safe body core temperature limit of 38 °C or excess water loss. 3 sets of clothing were investigated: 2 female sets of traditional clothes (churidar and saree) modified as used at construction site (added shirt and towel to protect traditional clothes and hair), and a male set commonly used at the construction sites. The clothing insulation and evaporative resistance were measured on thermal manikins. The climatic conditions were based on weather statistics, and metabolic heat production was based on field observations at work places and the ISO 8996:2004 tables (Ergonomics of the thermal environment — Determination of metabolic rate). For the future scenarios all basic parameters were left the same except the air temperature was increased by 2 °C. Adding the protective layer on female clothing did increase clothing insulation by 25-31 % and evaporative resistance by 10-18 % respectively. This affected the performance showing lower capacity to maintain work pace already under present climatic conditions. Further increase in mean air temperature may decrease the productivity by 30-80 % depending on the parameter that is observed (limited exposure time or lower work load), and on the earlier capacity to carry out the tasks. The present evaluation may have several limitations related to the PHS model's boundaries, and validation of the presented method application is needed.

²⁶ kalev.kuklane@design.lth.se

Keywords: heat, physiological model, productivity loss, work clothing.

INTRODUCTION

Human performance in heat has interested scientists for decades, and the contributing physiological factors have been studied extensively (Burse 1979, Smolander et al. 1987, Smolander et al. 1990, Weinman et al. 1967). Special attention has got exercise and military operations (Dill et al. 1973, Gisolfi and Copping 1974, Kamon et al. 1978, Nadel et al. 1980, Shapiro et al. 1981). One of the known researches who used the scientific methods to study and select workers for hot jobs and applied acclimatisation methods in mining industry was Wyndham (Wyndham 1962, Wyndham et al. 1954, Wyndham and Jacobs 1957 etc.). The aims of heat related studies have been to reduce heat induced disorders and to keep up productivity. Construction industry is strongly affected by weather. Both cold and heat do affect the productivity at the construction site (Koehn and Brown 1985, Mohamed and Srinavin 2002), and therefore, it is important to estimate climate effects on productivity for production planning (Shehata and El-Gohary 2011).

The climate change is affecting human health by increasing heat levels (IPCC 2007, 2014, World Bank 2012) and the potential impacts on occupational health and labor productivity was first referred to by Kjellstrom (2000) and in more detail in Kjellstrom et al. (2009). The increasing temperature of ocean surface water will create more evaporation resulting in higher absolute humidity of the atmosphere, affecting human thermal regulation due to reduced effectiveness of sweating (Dunne et al. 2013). When the ambient temperature reaches or exceeds the human core temperature of 37 °C, there are well documented physiological effects on the human body, posing risks to some organ systems and also making it progressively harder to work productively, especially in physically demanding work (Kjellstrom et al. 2009). In addition, other occupational health risks will increase as climate change progresses (Bennet and McMichael 2010). During the hottest month in the South-Indian afternoon; Wet-Bulb Globe Temperature (WBGT, ISO 7243:1989) levels are already high enough to cause major loss of hourly work capacity and this situation will become extreme for many jobs when facing future climate change. These trends will create longer periods of excessive heat exposure for people working outdoors or in non-cooled indoor factories and offices (Kjellstrom et al. 2013, Sett and Sahu 2014). Dunne et al. (2013) found under the highest scenario using Earth System Model (ESM2M) projections that by 2100, much of the tropics and mid-latitudes will experience months of extreme heat stress with a labour capacity reduction of about 40 % in peak months.

Various methods are used to estimate productivity loss in construction industry due to heat stress (Rowlinson et al. 2014). In earlier days temperature and humidity data was used (Koehn and Brown 1985) but with development of technology and models more sophisticated methods are used. Rational models or combinations of models should be preferable (Rowlinson et al. 2014). The personal properties/habits could be combined with thermal indexes, e.g. WBGT (ISO 7243:1989) for optimizing the work-rest schedules (Chan et al. 2012a, Chan et al. 2012b, Yi and Chan 2013). Including Predicted Mean Vote (PMV, ISO 7730:2005) into analysis allows human heat balance

calculations in the predictions (Mohamed and Srinavin 2005, Srinavin and Mohamed 2003). However, PMV was not intended for evaluation of hot environments and some modifications, e.g. extending the voting scales and combining it with WBGT is required. Predicted Heat Strain (PHS, ISO 7933:2004) is also based on human heat balance while it is intended to be used to evaluate human exposure to heat, making it a useful tool for performance predictions. Lately, PHS has been utilized for developing heat stress management guidelines for construction industry together with WBGT (Rowlinson and Jia 2013).

Human heat exchange with the environment is affected by clothing. Different clothing materials, body postures and motion velocities of the body all affect the insulation value of clothing ensembles. Comprehensive data on clothing insulation and evaporative resistance on western clothing are available, however, information on non-western clothing is lacking. A recent ASHRAE project 1504-TRP, Extension of the Clothing Insulation Database for Standard 55 and ISO 7730 dealt with the issue (Havenith et al. 2014). Simultaneously, an ongoing co-operation study at Indian workplaces (Venugopal et al. 2014) allowed us to acquire some sets of the traditional clothes used at construction sites in Chennai area. The study recorded present work conditions and the need for preventive measures. The results can also be used to improve the impact assessment models for workplace heat conditions in relation to climate change.

METHODS

Clothing

Three sets of clothing were investigated. Two female sets of traditional clothes "churidar" (X1) and "saree" (Y1) were modified as used at construction sites (added shirt and towel to protect traditional clothes and hair, X2 and Y2, respectively). A male clothing set (Z) commonly used at construction sites was also tested (see Figure 1). The clothing insulation was measured on thermal manikins in three laboratories and evaporative resistance was measured in one laboratory (Havenith et al. 2014).

Manikin tests at Lund University

Influence of postures and motion were studied at Lund University. The walking thermal manikin Tore is made of plastic with a metal frame inside to support the body parts and to simulate joints. Walking movements are created by pneumatic cylinders fixed to wrists and ankles. Tore is divided into 17 individually controlled zones: head, chest, back, stomach, buttocks, left and right upper arm, left and right lower arm, left and right hand, left and right thigh, left and right leg, and left and right foot. In addition, three air temperature sensors set at the heights of 0.1, 1.1 and 1.7 m were applied.

The air temperature in the chamber was set at 22.2 ± 0.1 °C. The mean radiant temperature was considered to be equal to the air temperature. The air velocity in the chamber was 0.21 ± 0.07 m/s. During walking the tests the recommendation of ISO 15831 (2004) were followed where the step length of 0.65 m at 45 double steps per minute would give an estimated walking velocity of 0.98 m/s.

The surface temperature of the manikin was kept at 34 °C. The temperatures and heat losses were recorded at 10 second intervals. Data from the last 10 minutes of the

stable state was used for insulation calculation. Total insulation values were calculated according to the parallel method (ISO 15831:2004).

Each clothing ensemble was measured independently at least twice, i.e. the manikin was undressed and redressed between independent measurements. If the difference of the independent measurements was above 4 % an additional test was carried out.

Basis for predictions

We selected ISO 7933 on predicted heat strain (PHS) as a tool to estimate productivity loss in physical work related to reaching safe body core temperature limit of 38 °C. The calculation program version from 2013-08-23 was acquired from Prof. J. Malchaire.

The climatic conditions were based on weather statistics of Chennai area. The metabolic heat production was based on the field observations and the ISO 8996 tables. The basic conditions (Ta - air temperature, Tg - globe temperature, Tr - mean radiant temperature, RH - relative humidity, va - air velocity) were the following:

- activity 200 W, Ta=35 °C, Tg=38 °C, Tr=45.7 °C, RH=70 %, va=1.5 m/s in the shade;
- activity 200 W, Ta=35 °C, Tg=45 °C, Tr=67.3 °C, RH=70 %, va=1.5 m/s in the sun.

For the future scenarios all basic parameters were left the same except the air temperature was increased by 2 °C (keeping radiation level the same Tg also increased). The changed parameters were:

- Ta=37 °C, Tg=39.5 °C in the shade;
- Ta=37 °C, Tg=46.4 °C in the sun.

An acclimatized female (56 kg, 150 cm) and male (64 kg, 167 cm) were selected as reference persons according to the mean values that were measured at site.

Productivity loss was based on time difference to reach critical body core temperature at the same activity, or lower continuous work pace (metabolic rate in Watts (W)) to keep core temperature below 38 °C under new climate conditions. In some analysis rest breaks of 30 minutes were included to lower the body core temperature in cool (27 °C) area, and total effective work time was compared to the total time available (480 minutes; 8 hours). This notion of "tolerance time" has been tested in a study by Zhao et al. (2009). Drinking water was considered to be freely available.

RESULTS AND DISCUSSION

Differences in clothing insulation

The female clothing without shirt and head cover created insulation conditions similar to male workwear (Figure 1). Female workwear with the shirt and towel on the head had considerably higher insulation than male workwear for standing and seated postures. During walking, female workwear ventilated better and insulation dropped closer to male clothing. The permeability index of the traditional female clothing was somewhat higher in comparison to male workwear, while adding a shirt on top of them reduced permeability to some extent. In the conditions where people already work close to their heat tolerance capacity even small difference may cause considerable effect on productivity.

In hot conditions the clothing should allow for evaporation and enhanced ventilation. The traditional clothes are effective from this viewpoint. Any additional clothing layers do reduce the effect, diminish evaporation and thereby decrease body heat loss. Also, dehydration risk increases as the body increases sweat production in order to compensate for lower heat loss - unevaporated sweat is unnecessary water loss.

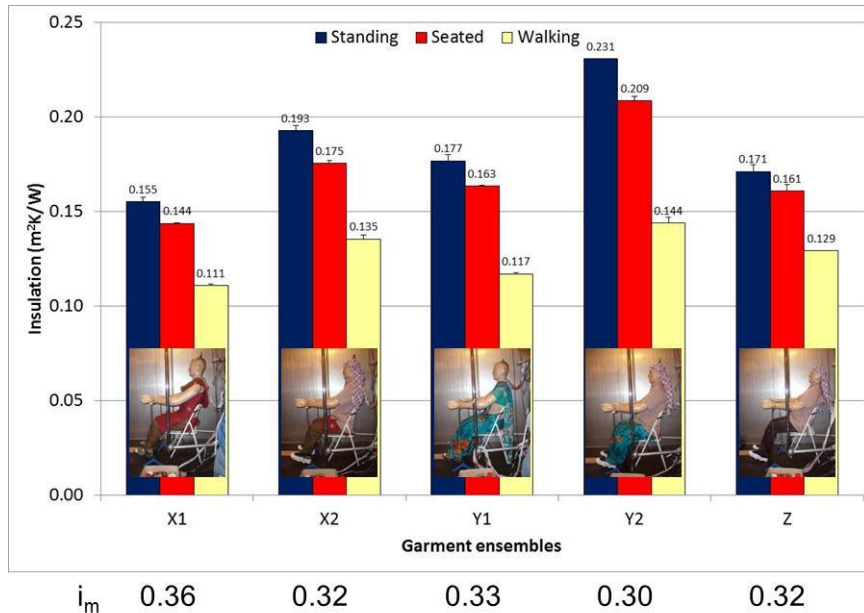

Figure 1. Workers' clothing from Chennai, India tested on thermal manikin Tore. i_m is clothing permeability index that depend on both insulation and evaporative resistance. The higher i_m value shows better thermal performance of the clothing.

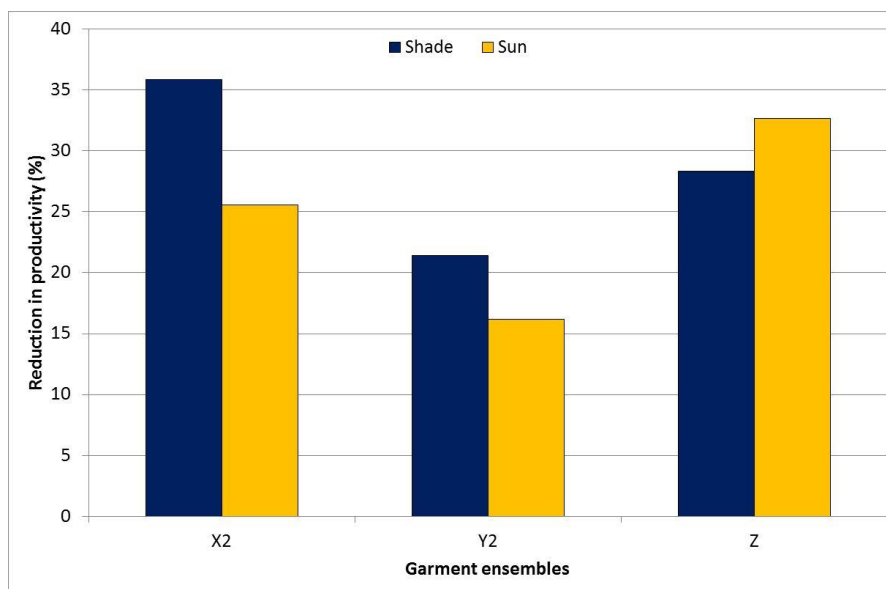

Figure 2. Predicted productivity reduction if the air temperature will be increased by 2 °C for workers in shade or exposed to solar radiation. If calculated body temperature reached 38 °C each time 30 minutes of rest was added to the work schedule.

Predictions of productivity loss

In clothing X1, Y1 and Z the workers could work in shade 8 hours at the defined load (200 W). The higher clothing insulation and evaporative resistance in modified female

clothing (Figure 1) affected the results showing lower capacity to maintain work pace already under present climatic conditions (Figure 2 and Table 1). Further increase in mean air temperature may decrease the productivity 30-80 % depending on the studied parameter (limited exposure time or lower work load), and on the previous capacity to carry out the tasks (Figure 2). If the capacity to carry out the tasks was already affected by the heat, e.g. in the sun, then the further percentage reduction was less than for work in the shade (Figure 2). However, in practice it means that workers already today need to reduce work during the hottest hours. In order to earn their living the length of the work day has to be prolonged (Kjellstrom 2009). This, in turn often leaves people with less time to take care of their homes and families, as distance between work and home may be long. Working in shade at described hot conditions assumed availability of drinking water at work places (Table 1). Exposure to sun and more extreme heat will create excess water loss, which may not easily be compensated except by rest and recovery in cool areas.

Table 1: Predicted productivity loss in shade if air temperature raises 2 °C. Icl is basic clothing insulation, i.e. insulation excluding air layer resistance and corrected for clothing area factor. Increased temperature, same activity considers keeping up the pace with the need for additional cooling breaks; increased temperature, reduced activity keeps on continuous work at lower pace/load.

Clothing	Basic condition			Increased temperature, same activity		Increased temperature, reduced activity		Productivity loss (%)	
	Icl (clo)	sweat (g/h)	time (min)	sweat (g/h)	time (min)	W	Time based	Load based	
X2	0.75	700	480	710	56	88 (8 h)	36	93	
Y2	1.06	660	84 (Y1->8h)	670	42	108 (84 min)	21	77	
Z	0.60	620	480	760	80	106 (8 h)	28	78	

CONCLUSIONS

Insulation

The female clothing without shirt and head cover had similar insulation to male workwear, while ventilation in female sets was better. Simultaneously, the female workwear with extra protective shirt had considerably higher insulation than male workwear for standing and seated postures. While walking the female workwear ventilated better and insulation became close to the male clothes, but did not perform better than male clothes. A new, affordable design of female workwear, that combines advantages of traditional clothes, fulfils traditional expectations and ensures protection requirements is needed. This could improve the heat stress situation for working women in hot places.

Productivity estimation

Productivity loss may be expected in most of the cases of this example. The loss would be between 16-36 % depending on working conditions and clothing. This fits with the estimations by Dunne et al. (2013) and comparison of brick workers walking velocities during winter and summer (20-39 %, Sett and Sahu 2014).

The clothing has a strong effect on productivity loss, especially, in the conditions that reach to the limits of human heat tolerance. In these conditions one garment piece may be one too much. In male workwear the relative productivity loss was the lowest. In female workwear (Y2) the productivity was already affected under present conditions, therefore, the relative loss was low.

Self-pacing has been shown to act as a protective mechanism against overheating of the body (Miller et al. 2011). If self-pacing is not possible then more frequent breaks are needed. Thus, productivity loss is reflected in time (more breaks) or lower pace or both. Availability of drinking water allows coping with heat and together with cool (<27 °C) recovery areas may be decisive for efficient work in the future.

Limitations

The present evaluation may have limitations related to better ventilation in traditional than in western clothes (Havenith et al. 2014) that the model is based on (Malchaire 2006). The work-rest schedule or planned work periods in cool areas may affect the results towards positive side, as well as availability of cooled recovery areas. Under outdoor conditions today, often only the shade may be provided while other ambient parameters stay the same as during the work, and the expectation of effectiveness of assumed 30 minute break may be too optimistic.

The human physiology based model PHS (predicted heat strain) was used here for the first time to estimate productivity loss during physical work in hot conditions. Therefore, validation of the presented method application is needed. Thermal discomfort itself can already cause distraction and reduction of productivity (Lan et al. 2011). The estimation of heat related reduction of mental performance under physical work would require different research methods.

ACKNOWLEDGEMENTS

The authors thank ASHRAE, USA; SIDA, Sweden for their support and Prof. J. Malchaire for advice on PHS.

REFERENCES

- ANSI/ASHRAE Standard 55-2004 (2004) Thermal Environmental Conditions for Human Occupancy. American Society of Heating Refrigeration and Air-conditioning Engineers. ASHRAE Inc., Atlanta, USA.
- Bennett, C M, McMichael, A J (2010) Non-Heat Related Impacts of Climate Change on Working Populations. *Global Health Action*, 2010; 3: 5640, DOI: 10.3402/gha.v3i0.5640.
- Burse, RL (1979) Sex differences in human thermoregulatory response to heat and cold stress. *Human Factors*, 1979; 21 (6): 687-699.
- Chan, APC, Wong, FKW, Wong, DP, Lam, EWM, Yi, W (2012a) Determining an optimal recovery time after exercising to exhaustion in a controlled climatic environment: Application to construction works. *Building and Environment* 2012; 56: 28-37.
- Chan, APC, Yi, W, Wong, DP, Yama, MCH, Chan, DWM (2012b) Determining an optimal recovery time for construction rebar workers after working to exhaustion in a hot and humid environment. *Building and Environment* 2012; 58: 163-171.
- Dill, DB, Yousef, MK, Nelson, JD (1973) Responses of men and women to two-hour walks in desert heat. *Journal of Applied Physiology* 1973; 35 (2).

- Dunne, J P, Stouffer, R J, John, J G 2013 Reductions in labour capacity from heat stress under climate warming. *Nature Clim. Change*, 2013; 563-566, DOI:10.1038/nclimate1827.
- Gisolfi, CV, Copping, JR (1974) Thermal effects of prolonged treadmill exercise in the heat. *Medicine and Science in Sports*; 1974, 6 (2): 108-114.
- Havenith, G, Hodder, S, Ouzzahra, Y, Loveday, D, Kuklane, K, Lundgren, K, Fan, J, Au, Y (2014) Extension of the Clothing Insulation Database for Standard 55 and ISO 7730 to provide data for Non-Western Clothing Ensembles, including data on the effect of posture and air movement on that insulation. Report on manikin measurements for ASHRAE 1504-TRP.
- IPCC (2007) IPCC Forth Assessment Report: Climate Change. Geneva: International Panel on Climate Change, Switzerland.
- IPCC (2014) IPCC Fifth Assessment Report: Impacts, Adaptation and Vulnerability. Geneva: International Panel on Climate Change, Switzerland.
- ISO 15831:2004 (2004) Clothing - Physiological effects - Measurement of thermal insulation by means of a thermal manikin. International Organization for Standardization, Geneva.
- ISO 7243:1989 (1989) Hot Environments - Estimation of the heat stress on working man, based on the WBGT- index (wet-bulb globe temperature). International Organization for Standardization, Geneva.
- ISO 7730:2005 (2005) Ergonomics of the thermal environment. Analytical determination and interpretation of thermal comfort using calculation of the PMV and PPD indices and local thermal comfort criteria, International Organization for Standardization, Geneva.
- ISO 7933:2004 (2004) Ergonomics of the thermal environment – Analytical determination and interpretation of heat stress using calculation of the predicted heat strain. International Organization for Standardization, Geneva.
- ISO 8996:2004 (2004) Ergonomics of the thermal environment — Determination of metabolic rate. International Organization for Standardization, Geneva.
- Kamon, E, Avellini, B, Krajevski, J (1978) Physiological and biophysical limits to work in the heat for clothed men and women. *Journal of Applied Physiology: Respirat. Environ. Exercise Physiol.* 1978; 44 (6): 918-925.
- Kjellstrom, T (2000) Climate change, heat exposure and labour productivity. Proc. ISEE 2000, 12th Conference of the International Society for Environmental Epidemiology, Buffalo, USA, August, 2000. *Epidemiology*, 2000; 11: S144.
- Kjellstrom, T (2009) Climate change, direct heat exposure, health and well-being in low and middle income countries. *Global Health Action*, 2, (www.globalhealthaction.net).
- Kjellstrom, T, Holmer, I, Lemke, B (2009) Workplace heat stress, health and productivity – an increasing challenge for low and middle income countries during climate change. *Global Health Action* 2 (www.globalhealthaction.net), doi: 10.3402/gha.v2i0.2047.
- Kjellstrom, T, Lemke, B, Otto, M (2013) Mapping Occupational Heat Exposure and Effects in South-East Asia: ongoing time trends 1980-2011 and future estimates to 2030 and 2050. *Industrial Health*, 2013; 51 (1): 56-67.
- Koehn, E, Brown, G (1985) Climatic Effects on Construction. *Journal of Construction Engineering and Management*, 1985; 111 (2): 129-137.
- Lan, L, Wargocki, P, Lian, Z (2011) Quantitative measurement of productivity loss due to thermal discomfort. *Energy and Buildings* 2011; 43 (5): 1057–1062

- Malchaire, JBM (2006) Occupational Heat Stress Assessment by the Predicted Heat Strain Model. *Industrial Health*, 2006; 44: 380-387.
- Miller, V, Bates, G, Schneider, JD, Thomsen, J (2011) Self-Pacing as a Protective Mechanism against the Effects of Heat Stress. *Annals of Occupational Hygiene* 2011; 55 (5): 548–555.
- Mohamed, S, Srinavin, K (2002) Thermal environment effects on construction workers' productivity. *Work Study*, 2002; 51 (6): 297-302.
- Mohamed, S, Srinavin, K (2005) Forecasting labor productivity changes in construction using the PMV index. *International Journal of Industrial Ergonomics* 2005; 35 (4): 345–351.
- Nadel, ER, Fortney, SM, Wenger, CB (1980) Effect of hydration state on circulatory and thermal regulations. *Journal of Applied Physiology: Respirat. Environ. Exercise Physiol.* 1980; 49 (4): 715-721.
- Rowlinson, S, Jia, AY, Lia, B, Ju, CC (2014) Management of climatic heat stress risk in construction: A review of practices, methodologies, and future research. *Accident Analysis and Prevention* 2014; 66: 187–198.
- Rowlinson, S, Jia, AY (2014) Application of the Predicted Heat Strain Model in Development of Localized, Threshold-based Heat Stress Management Guidelines for the Construction Industry. *Annals of Occupational Hygiene* 2014; 58 (3): 326-339.
- Sett, M, Sahu, S (2014) Effects of occupational heat exposure on female brick workers in West Bengal, India. *Global Health Action* 2014; 7: 21923 - <http://dx.doi.org/10.3402/gha.v7.21923>
- Shapiro, Y, Pandolf, KB, Avellini, BA, Pimental, NA, Goldman, RF (1981) Heat balance and transfer in men and women exercising in hot-dry and hot-wet conditions. *Ergonomics* 1981; 24 (5): 375-386.
- Shehata, ME, El-Gohary, KM (2011) Towards improving construction labor productivity and projects' performance. *Alexandria Engineering Journal* 2011; 50 (4): 321–330.
- Smolander, J, Ilmarinen, R, Korhonen, O, Pyykko, I (1987) Circulatory and thermal responses of men with different training status to prolonged physical work in dry and humid heat. *Scandinavian Journal of Work, Environment and Health* 1987; 13 (1): 37-46.
- Smolander, J, Korhonen, O, Ilmarinen, R (1990) Responses of young and older men during prolonged exercise in dry and humid heat. *European Journal of Applied Physiology and Occupational Physiology*, 1990; 61 (5-6): 413-418.
- Srinavin, K, Mohamed, S (2003) Thermal environment and construction workers' productivity: some evidence from Thailand. *Building and Environment* 2003; 38 (2): 339–345.
- Venugopal, V, Kjellström, T et al. (2014) SWEDEN-India Cooperation on Protection of Working People from Health and Productivity Risks due to Workplace Heat Exposure and the Links to Climate Change. Final project Report. Sri Ramachandra Medical College and Research Institute, Chennai, India (to be published).
- Weinman, KP, Slabochova Z, Bernauer, EM, Morimoto, T, Sargent II, F (1967) Reactions of men and women to repeated exposure to humid heat. *Journal of Applied Physiology* 1967; 22 (3): 533-538.
- World Bank (2012) Turn Down the Heat – Why a 4°C warmer world must be avoided. Washington: the Potsdam Institute for Climate Impact Research and Climate Analytics 2012; USA.

- Wyndham, CH (1962) Tolerable limits of air conditions for men at work in hot mines. *Ergonomics* 1962; 5 (1): 115-122.
- Wyndham, CH, Jacobs, GE (1957) Loss of acclimatization after six days of work in cool conditions on the surface of a mine. *Journal of Applied Physiology* 1957; 11 (2): 197-198.
- Wyndham, CH, Strydom, NB, Morrison, JF, du Toit, FD, Kraan, JG (1954) Thermal responses of men with high initial temperatures to the stress of heat and work. *Journal of Applied Physiology* 1954; 6 (11): 687-690.
- Yi, W, Chan, APC (2013) Optimizing worker rest schedule for construction rebar workers in hot and humid environment. *Building and Environment* 2013; 61: 104-113
- Zhao, J, Zhu, N, Lu, S (2009) Productivity model in hot and humid environment based on heat tolerance time analysis. *Building and Environment* 2009; 44 (11): 2202–2207.

Proactive health and safety

EXPLORING THE UTILITY OF CONSTRUCTION INDUSTRY 'SAFETY CULTURE'

Fred Sherratt²⁷

¹ Anglia Ruskin University, Bishop Hall Lane, Chelmsford, CMI 1SQ

Safety culture has come to the forefront of pro-active safety management in the UK construction industry. However, agreement as to what a safety culture actually is, how to measure it, or how to effectively develop one has yet to be established. Academics have produced different definitions, models and conceptualisations in attempts to answer these questions, developed from different methodological foundations. Large contractors in the UK have developed bespoke brands for their safety culture programmes, and implemented several management practices considered to be key contributors to a positive safety culture. Yet this context raises several questions about the basic function of 'construction safety culture' for both academia and industry; any definition or model of safety culture must be relevant to those seeking to manage health and safety in practice. Consequently, in-depth interviews were held with four senior health and safety practitioners working for large contractors in the UK, to explore and identify what they wanted to do with 'safety culture', or alternatively, wanted 'safety culture' to do as a concept for them. Whilst overlap was identified with existing academic conceptualisations in terms of practice, the contemporary challenge for senior health and safety management is focused on the engagement of the workforce and industry supply chains. Arguably, traditional construction management research approaches have been derived from normative conceptualisations of culture, and do not fully address this social aspect of site life. It is suggested that a shift to an anthropological conceptualisation of construction site safety culture alongside ethnographic research is needed to provide practitioners with new insights and understandings around engagement, to support effective interventions that can develop and strengthen the safety culture of large UK sites.

Keywords: safety culture, safety management, utility

INTRODUCTION

The quest for a positive safety culture has become an inherent part of safety management for large UK construction organisations (Ridley and Channing 2008). Although it is a popular safety management tool in industry, 'safety culture' remains an elusive and intangible concept and despite considerable research, academics cannot agree on a definition (Edwards et al 2013),

Research continues to develop more complex and varied conceptualisations of safety culture, reflective of differing ontological and epistemological foundations and more detailed models of the environments they represent. However, increased complexity does not necessarily support increased utility: for example the inclusion of systemic and organisational causes has created increasingly intricate accident causality models, but with potentially less relevance to the existing realities of work (Hovden et al

²⁷ Fredsherratt@btinternet.com

2010). This echoes previously established concerns that many academic tools and systems have proved impractical and unwieldy when applied to practice (Campbell and Smith 2006).

This study therefore takes the first steps in exploring safety culture from the perspectives of health and safety practitioners within the UK construction industry. Rather than seek to define or identify potential improvements, the study focused on the utility of the concept and sought to establish what health and safety managers wanted to do with 'safety culture', or alternatively wanted 'safety culture' to do as a concept within their safety management toolkit. It is suggested that applicability to practice should be explored in order to ensure future academic conceptualisations of safety culture are functional and able to consider, develop from and synthesise with current practices and thinking on construction sites.

CONTEXT

Concepts of Safety Culture

Despite its prominence in both organisational safety research and practice, there has yet to be an agreed definition of what 'safety culture' is, and research in this area remains fragmented (Antonsen 2008). Within construction management research, no consensus has been reached for an industry specific definition, agreement how to measure safety culture on sites, or even how to establish or develop one (Wamuziri 2011). A large variety of models and processes have been developed which attempt to answer these questions (see for example Ridley and Channing 2008; Mohamed and Chinda 2011; Maloney 2011; Wamuziri 2011; Fang and Wu 2013), yet a coherent definition or conceptual framework has yet to be agreed.

Safety culture is widely accepted to be a sub-culture of wider organisational culture (Choudhry et al 2007; Fang and Wu 2013), rather than a separate culture in itself, although organisations themselves are considered to consist of many sub-cultures (Edwards et al 2013) rather than a homogenous single culture. When the construction industry is considered, the role of autonomous projects and sites away from the organisational centre adds further complexity. Fang and Wu (2013) suggest that a unique project safety culture will evolve as each project progresses on site, contributed to by the organisational safety cultures of the subcontractors involved. Fellows and Liu (2013) differ in their opinion, dismissing project culture as neither unique nor independent, suggesting that the longevity and enduring nature of the contributory organisational cultures simply creates a temporary amalgam.

Notions of multiple and multi-layered cultures have also been put forward (Denison 1996), and have been developed to suggest that concurrent safety cultures can operate at different organisational levels, for example the management and the workforce (Dov 2008). Others have suggested that safety culture is a dynamic concept and, drawing on social constructionist theory, suggest that safety culture will be created and recreated through each workplace encounter throughout the day (Richter and Koch 2004). This has been identified within the UK construction site context, where safety culture was found to be inconsistent, incomplete and incidental to the main focus on production, as well as being multi-layered (Sherratt et al 2013), suggesting differences between organisational policy and practice (Dov 2008).

However, some have been highly vocal in their dismissal of safety culture as a concept. For example, Antonsen (2009) states that there is no such thing as 'safety

culture', rather different aspects of an organisational culture that can affect safety practice. He also argues that the complexity of the processes that create culture make isolation and extraction of 'safety culture' impossible. Perrow (1999) was also clear in his stance towards safety culture as a concept, refusing to consider it within his seminal work on safety accidents, precisely because of doubts around its utility.

Safety Culture Research in the Construction Industry

Despite these complexities, conceptualisations and challenges around safety culture it remains prominent in construction safety management research. Variations in approach have been closely linked to the methodological groundings and accepted academic frameworks of the field under examination (Glendon 2008); consequently for construction safety culture, research has taken a scientific approach, through a realist ontology and positivist epistemology (Dainty 2008).

This has developed normative conceptualisations (Edwards et al 2013) of safety culture within the construction industry. From a management perspective, this can be seen as the most practical; culture is based on organisational policy and practice, allowing for easy measurement against processes and systems in practice (Antonsen 2008; Glendon 2008) through management tools like on-site checklists.

In addition, and to draw further from Edwards et al's conceptualisations of safety culture, a pragmatic perspective has also been applied, viewing safety culture in terms of positive or negative practical contributions to its development (Edwards et al 2013). This can be seen in various models (Choudhry et al 2007) and examinations of factors (Wamuziri 2011) that have been put forward as characteristic of a positive construction safety culture. Such practical contributions have included top down management commitment, worker engagement with formal and informal communications on safety matters, safety training, encouragement of safe behaviours, and a 'no-blame culture' to encouraging accident and near miss reporting.

Often pragmatic approaches also rely on a scientific foundation for their measurement, and consequently there has been a reliance on surveys and questionnaires (Guldenmund 2007) to capture 'safety climate'. Safety climate has become the accepted measure and indicator of the wider safety culture (Fang and Wu 2013), potentially because of epistemological problems associated with more subjective measurements of culture itself.

However, it can be argued that this construction industry conceptualisation has shifted focus to safety management and systems, rather than any true cultural conceptions built upon its original ethnographic roots (Denison 1996). The anthropological conception of culture, which examines aspects that cannot be captured through normative measurement and instead seeks insight and exploration through underlying beliefs, attitudes and values (Edwards et al 2013) has been largely ignored. The challenge to link soft safety culture studies to hard process management practices (Glendon 2008) has not been met, and in the construction industry the desire for 'hard data' (Choudhry et al 2007:1001) appears dominant in both academic and industry perspectives.

Safety Culture Practices in the UK Construction Industry

Safety culture has become a prominent safety management tool and is commonplace in practice (Wamuziri 2011; Mohamed and Chinda 2011; Biggs et al 2013). In the UK, a proactive safety culture is supported and promoted by the Health and Safety

Executive (HSE), who see it as essential to improving the safety record of the industry (HSE 2000), and it is firmly at the forefront of the safety management practices of large UK contractors (Donaghy 2009)

In practice, true to normative and pragmatic perspectives, this has led to a focus on elements that can be managed, measured and controlled through safety management systems. These include regular scheduled safety meetings, tool box talks, inspections and behavioural safety programmes implemented through goals and feedback (Choudhry et al 2007). However, these systems are supported by the clear recognition that people and communication are also vital, through senior and site management commitment (Hughes and Ferrett 2007) as well as worker engagement (HSE 2007). The HSE (2011) have developed specific Worker Engagement Initiatives and seek a '... step-change in the health and safety culture of the construction industry.' The use of a 'no-blame culture' is often considered to support a positive safety culture (Dekker 2007) to allow open communication and reporting.

Branded safety culture programmes are now commonplace on large UK sites, seeking to encourage engagement with safety management, and to promote communication and safe working by choice, rather than enforcement (Baram and Schoebel 2007). This creates an environment focused on the development of safety culture, although the HSE (2008) has not yet been able to establish firm evidence of the success of these types of programmes, despite positive reports of their implementation.

The Utility of Safety Culture

It is from these perspectives that the utility of current conceptualisations of safety culture to construction industry practices should be considered. It can be suggested that there is a fundamental conflict in the construction management research of safety culture, much of which is in reality examining organisational safety climate, and that actual understandings of construction site safety culture from an ethnographical perspective are much more limited.

Safety culture on sites has been used to ensure safety management systems are in place and that various prescriptive elements of a 'positive safety culture', as identified through construction industry research, are implemented through safety culture programmes. Yet this has arguably limited the potential for 'safety culture' to provide new perspectives and approaches to safety management in practice. The dominance of normative and pragmatic conceptualisations has resulted in the neglect of its ethnographic roots, and arguably removed any social aspects from its consideration. Yet recognition of social considerations can be identified in industry practices as worker engagement and the communication of health and safety on sites.

Consequently, there is the potential for wider considerations of safety culture to be of greater utility to practitioners. The relevance of 'safety culture' to practice should be explored. It may be possible that normative conceptualisations of culture are actually of most use to practitioners, providing a prescription for a valid safety culture on their sites. Alternatively, there may be the need to consider the social aspects more deeply, through anthropological conceptualisations, which may actually be able to support improvements in communication and engagement that industry is seeking in practice.

METHODOLOGY

As the title of this paper suggests, this study is at the first stages of an examination of site safety culture from a functional perspective, and to explore its use in practice. A qualitative and interpretivist approach was therefore employed, to begin to seek the experiences and understandings (Cresswell 2003; Dainty 2008) of those for whom safety culture forms part of their working life. To ensure ethical process in the collection of this data, the project was carried out with adherence to the University Code of Practice on Ethical Standards for Research Involving Human Participants; it was subject to ethical review and received a favourable ethical opinion for conduct.

Due to the specific nature of the phenomena under investigation and the need to approach those with relevant experience and knowledge of safety culture, a judgemental sampling technique (Silverman 2001; Creswell 2003) was used to purposefully select respondents from the population of those currently working in a senior health and safety management role within a construction organisation that publicly operated a safety culture programme. This sample was also one of convenience, drawn from the researcher's own industry network.

Four senior health and safety managers currently working for large construction contractors in the UK made up the final sample. This small number enabled the research to begin to explore how the practitioners used safety culture within their work, and to seek out initial thoughts and ideas in this area. This empirical work forms the very first carried out within this project, and rather than claim any generalisation or its ability to withstand tests of validity, it simply intends to provide initial insights and illumination to support the development of the next stages of this work.

The interviews employed open questions to allow for more informal discussions to develop, led by the respondents. A brief safety scenario was also included within the interviews to enable the respondents to select what practical actions they thought reflected a positive safety culture, and to prompt further unstructured discussions. The interviews and scenario discussions were recorded, transcribed and coded using NVIVO 8 to explore the dominant themes, consistencies and inconsistencies (Silverman 2001) around the utility and function of safety culture in practice.

The key themes have been presented here in the form of a narrative, building towards the development of a functional model of construction site safety culture.

FINDINGS AND DISCUSSION

As suggested by the literature (Antonsen 2008), no consensus was made as to what 'safety culture' was amongst the respondents. A variety of 'definitions' were used, from the quotation "it's how we do things round here", to the consideration that it is something embedded in the organisation from the top down, to the idea that it is simply a "buzzword", to the more abstract idea that "... where we talk about culture we don't necessarily refer to anything in particular."

Wider discussions demonstrated that culture was most closely associated with people, their behaviours, attitudes and values, as well as the clear acknowledgement that because of this, there was also great variation. As one respondent stated "... there's a percentage of them who will be brilliant, you know, work to their method statements and risk assessments, they'll understand safety, they'll understand, y'know, risks,

whereas you've always got a percentage who won't." This was supported by another respondent who noted that "... on sites where we've got poor performance you do see nuggets of individuals who will do the right thing."

This variation amongst individuals, groups and even sites was a prominent theme in all discussions, providing support to concepts of multiple and multi-layered cultures as suggested by several organisational safety culture theories (Denison 1996; Dov 2008). All respondents agreed that variation could be identified between different projects, as well as the presence of variation in safety cultures on one individual site. This was closely related to the supply chain; some subcontractors were felt to be "... more developed than others". Furthermore, the use of transient labour within the industry was seen as having significant influence, the use of agency workers destabilising the workforce and therefore reducing the potential for a positive safety culture to grow.

However, such socially grounded variation is not easily considered within the pragmatic and normative conceptualisations of construction management safety cultures found in the literature, which focus on compliance with process and policy. Whilst practice also feels the need for measurement, manifested as statistics or key performance indicators (KPIs), as an integral part of culture, it also acknowledges the inconsistent nature of the sites and their people in the form of contextual causes to these subsequent effects.

Safety Culture in Practice

The respondents had common experiences of the implementation of 'safety culture' in practice. Initiatives and both safety culture and behavioural safety training programmes were developed by senior management at the strategic level and cascaded down to projects and sites, yet this was not felt by all to be an entirely effective process: "... it starts off a great and powerful and interesting idea at the top, but by the time it's got to the front ... they ask you what is it again ... [it is] that diluted to the extent that you're asking me what the hell it is?"

Issues in communication and implementation of the safety culture message were often addressed by the articulation of senior management leadership and support. Clear organisational policy and demonstrable commitment was felt to be essential for safety culture; "... we're going to do what we said we're going to do, and we're going to demonstrate to you that we believe in it ... if we haven't got that, then all this stuff is just a waste of time."

As well as leadership and communication, workforce engagement was also prominent in discussions. The inclusion of the workforce in safety culture practices was seen as key to their engagement, for example in the preparation of their own method statements and risk assessments, "they're the best people to say this is how you can do it safely." Notions of engagement also expanded to include responsibility and personal accountability, which were felt to both support and develop safety culture: "... you do see people believing in it then, because they feel ownership towards it." However, the concept of safety culture was itself not felt to be of particular utility at this level, whilst it was "... useful at a strategic level but for the plasterer guy or whatever, he'd probably say 'well what does that mean to me?'".

One respondent went on to suggest that safety culture initiatives should be aimed at the bottom of the management chain, and allowed to percolate upwards, whilst another suggested that communication was vital "... not just downstream but very

importantly upstream." Between 'top-down' and 'bottom-up' three of the respondents also identified a "stalling" point at the middle levels of the management chain. This was identified as the point where safety met practice, and the influences of work pressure became most severe; safety culture becoming lost in the requirements of practice. Indeed, without any practical substance to 'safety culture' in the form of management practices or actions to "drive it along", it often became just "... froth".

Safety Culture and Safety Management Practices

The substance of safety culture was found to mainly consist of traditional safety management practices, although this was supported in one instance by a behavioural safety training programme. Although as previously noted, senior management commitment was considered vital, this was simply to support adherence to the safety management systems in operation. Standards for work practice, permits, procedures, control measures, safe systems of work, safety rules and inspections were all closely associated with safety culture by the respondents. These are all normative and pragmatic elements of safety culture (Edwards et al 2013), and whilst the respondents felt that these management practices were indicators of positive safety cultures, they also considered the wider context of their implementation by the site teams.

Three of the respondents felt that it was the process of enforcement of the rules and regulations that was vital for a good safety culture; "... if you don't have these rules then the safety culture is going to be well, we don't really give a flying toss, but if you do have these rules and if you do have these procedures and measures in place the guy on site's going to think 'I'll just be careful, I need to watch myself on here', so yeah I do think we do use the safety culture". Yet all respondents agreed that safety culture was dependent on a certain type of site management; managers who do not turn a blind eye, managers with the will to follow the correct procedures, managers who are committed to the safety practices they are carrying out, managers who are willing to stop production for safety, as one respondent said "... good managers produce good results". This was further clarified by another respondent "... if they know they can't get away with taking risks and more importantly that they know we would rather delay the job a week and have no accidents than hand over on time and have a guy who's broken their leg, then they do see it." Arguably, the abilities of the site management teams to act in this way are themselves supported by the senior management commitment to the prioritisation of safety over production.

The Utility of Safety Culture: Practitioner Perspectives

These findings suggest relationships between dominant elements that comprise site safety culture; senior management commitment enables site management to fully enforce the processes and procedures within their SMSs, and tips the balance from production to safety, whilst workforce engagement ensures commitment by all to make them effective in practice.

This supports the theories put forward through normative and pragmatic models and conceptualisations of site safety culture (Choudhry et al 2007), aligning to safety management systems, policy and organisational practices.

However, it is workforce engagement that has come to the fore as the most challenging element of safety management for these health and safety professionals. They are now seeking solutions to these more social considerations of culture; communication and ultimately engagement of their workforce and supply chains. As

one respondent stated a "... percentage will feel like they can take a risk, and that taking a risk normally ends up in an accident, so I think for me I would like safety culture to basically tell me how you get through to them, that small percentage.". This developed to a practical conceptualisation of culture where the workforce "... will do the right thing because they want to do it, not necessarily because they have to do it, they can see the value in doing it," ultimately making the respondents' jobs obsolete; "... where I can come onto site and it's like I can't really fault what you're doing."

Therefore it can be suggested that the focus should shift from a conceptualisation of safety culture grounded in practices, processes and procedures, to more social and indeed ethnographical considerations. Indeed, the utility of safety culture to the professionals can be seen as its ability to support engagement and communication of health and safety within the main contractor organisation, on its projects and all along its supply chains.

CONCLUSIONS

This study has begun to explore construction site safety culture from a very specific perspective, that of senior health and safety practitioners. In asking what they wanted safety culture to 'do' for them, whilst multiple and multi-layered concepts of culture resonated with their experiences, the findings also suggested that the normative and pragmatic conceptions commonly used to ground construction site safety culture did not address all concerns.

All respondents felt the contemporary function of safety culture was to reach those who are not currently engaged; and its utility will come from achieving this safety management goal. The autonomous nature of construction work means that despite strong site management working within a positive safety culture, without this engagement safety incidents may still occur.

FUTURE RESEARCH

Moving forward from safety culture conceptualisations based on practices and processes, although not neglecting them as vital in laying foundations, it is suggested that safety culture research should also look to the social interactions, which manifest as engagement, which are necessary to support their effective implementation. Such relationships within the construction industry environment are suggested in Figure 1.

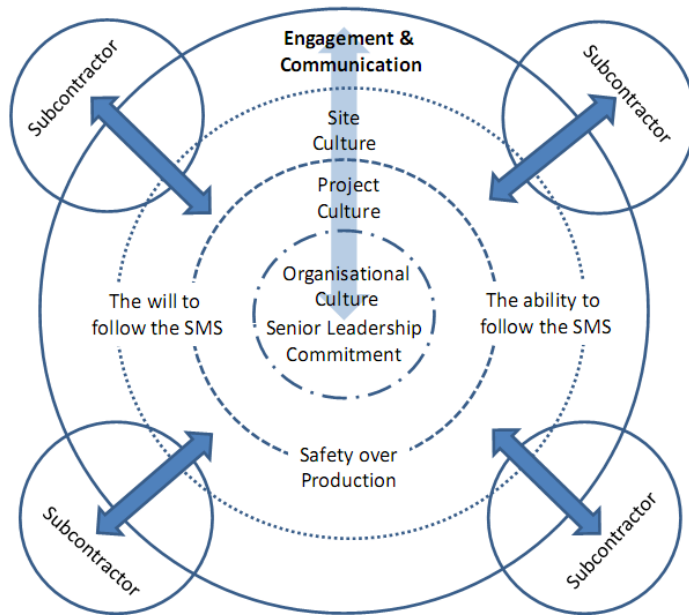

Figure 1: Relationships of Engagement and Communication

Based on Hofstede's (2005:7) 'onion', and drawn from the elements the respondents felt were most useful in their understandings of safety culture, Figure 1 illustrates engagement and communication within the organisational, project and site cultures, as well as the necessary considerations to practice within these environments that can further influence engagement.

Yet in order to research and explore the complex relationships suggested in Figure 1, anthropological conceptualisations of culture are required which focus on people and their interactions, behaviours, attitudes and variations. In order to explore this aspect of safety culture, research grounded in alternative paradigms will be required, seeking ethnographic and constructionist approaches to provide alternative perspectives. Such approaches may provide fresh insights and enable the development of new initiatives to help industry and its supply chains become engaged and, as one respondent stated, "... self-regulating, with (safety) embedded in the culture and the DNA ..."

This paper presents the very first steps in a larger research project that aims to explore the anthropological aspects of construction industry culture, and seeks to develop a conceptualisation of construction site culture with enhanced utility to practitioners, and can support the development of more effective health and safety engagement in practice.

REFERENCES

- Antonsen, S (2008) "Safety Culture – Theory, Method and Improvement". Ashgate Publishing Limited: Farnham.
- Antonsen, S (2009) Safety culture and the issue of power "Safety Science" 47(2) 183-191.
- Baram, M and Schoebel, M (2007) Editorial: Safety culture and behavioural change at the workplace. "Safety Science", 45(6), 631-636.

- Biggs, S E, Banks, T D, Davey, J D, Freeman, J E (2013) Safety leader's perceptions of safety culture in a large Australasian construction organisation. "Safety Science", 52, 3-12.
- Campbell, J M and Smith, S D (2006) Improving industrial value and longevity of safety management research. In: Boyd, D (Ed.), "22nd Annual ARCOM Conference", 4-6 September 2006 Birmingham, UK. Association of Researchers in Construction Management, Vol. 1, 263-71.
- Choudhry, R M, Fang, D, and Mohamed, S (2007) The nature of safety culture: A survey of the state-of-the-art. "Safety Science" 45(10), 993-1012.
- Creswell, J W (2003) "Research Design: Qualitative, Quantitative and Mixed Methods Approaches". 2ed. London: Sage Publications Limited.
- Dainty, A R J (2008) Methodological Pluralism in Construction Management Research. In: Knight, A., Ruddock, L. (Eds.) "Advanced Research Methods in the Built Environment". Oxford: Blackwell Publishing Limited.
- Dekker, S (2007) "Just Culture: Balancing Safety and Accountability". Surrey: Ashgate Publishing Limited.
- Denison, D R (1996) What is the difference between organisational culture and organisational climate? A native's point of view on a decade of paradigm wars. "Academy of Management Review" 21(3) 619-654.
- Donaghy, R (2009) "One Death is too Many - Inquiry into the Underlying Causes of Construction Fatal Accidents". Norwich: The Stationary Office.
- Dov, Z (2008) Safety climate and beyond: A multi-level multi-climate framework. "Safety Science" 46(3) 376-387.
- Edwards, J R D, Davey, J and Armstrong, K (2013) Returning to the roots of culture: A review and re-conceptualisation of safety culture. "Safety Science" 55 70-80.
- Fang, D, and Wu, H (2013) Development of a Safety Culture Interaction (SCI) Model for construction projects. "Safety Science" 57 138-149.
- Fellows, R and Lui, A M M (2013) Use and misuse of the concept of culture. "Construction Management and Economics" 31(5) 401-422.
- Glendon, I (2008) Safety culture and safety climate: how far have we come and where could we be heading? "Journal of Occupational Health and Safety Australia and New Zealand" 24(3) 249-271.
- Guldenmund, F W (2007) The use of questionnaires in safety culture research - an evaluation. "Safety Science" 45(6), 723-743.
- Health and Safety Executive (2000) "Construction Health and Safety for the New Millennium". Suffolk: HSE Books.
- Health and Safety Executive (2007) "Managing Health and Safety in Construction - Construction (Design and Management) Regulations 2007 (CDM) Approved Code of Practice". Suffolk: HSE Books.
- Health and Safety Executive (2008) "RR660: Behaviour Change and Worker Engagement Practices within the Construction Sector" Norwich: HMSO.
- Health and Safety Executive (2011) Worker Engagement Initiative. <http://bit.ly/PUAnA5> (April 10, 2014).
- Hofstede, G and Hofstede G J (2005) "Culture and Organisations: Software of the Mind" 2ed. New York: McGraw-Hill.

- Hovden, J, Albrechtsen, E and Herrera, I A (2010) Is there a need for new theories, models and approaches to occupational accident prevention? "Safety Science" 48(8) 950-956.
- Hughes, P and Ferrett, E (2007) "Introduction to Health and Safety in Construction". 2ed.. Oxford: Butterworth- Heinemann.
- Maloney, B., 2011. Conceptual Model of Safety Culture for Construction. In: Lew, J. (Ed.), Proceedings of CIB W099 - Prevention: Means to the End of Construction Injuries, Illnesses and Fatalities. CIB: Washington DC.
- Mohamed, S and Chinda. T (2011) System dynamics modelling of construction safety culture. "Engineering, Construction and Architectural Management" 18(3), 266-281.
- Perrow, C (1999) "Normal Accidents – Living with High Risk Technologies". Chichester: Princeton University Press.
- Richter, A and Koch, C (2004) Integration, differentiation and ambiguity in safety cultures. "Safety Science" 42(8), 703-722.
- Ridley, J and Channing, J (2008) "Safety at Work" 7ed. Oxford: Butterworth Heinemann.
- Sherratt, F, Farrell, P and Noble, R (2013). Construction Site Safety: Discourses of Enforcement and Engagement. "Construction Management and Economics" 31(6), 623-635.
- Silverman, D (2001) "Interpreting Qualitative Data : Methods for analysing talk, text and interaction". 2ed. London: Sage Publications Limited.
- Wamuziri, S (2011) Factors that Contribute to Positive and Negative Health and Safety Cultures in Construction. In: Lew, J. (Ed.), "Proceedings of CIB W099 - Prevention: Means to the End of Construction Injuries, Illnesses and Fatalities". CIB: Washington DC.

THE DEVELOPMENT OF AN AUTOMATED MULTI-LEVEL SAFETY CLIMATE BENCHMARKING TOOL FOR CONSTRUCTION PROJECTS

Ruwini Edirisinghe²⁸, Rita Zhang, Helen Lingard and Frank Boukamp

¹RMIT University, School of Property, Construction and Project Management, GPO Box 2476, Melbourne VIC 3001, Australia

Purpose: The Australian construction industry has been identified as a priority industry in the Australian Work Health and Safety Strategy 2012-2022. Safety climate models can be used as diagnostic tools for workplace health and safety problems.

Design/methodology/approach: This paper argues that safety climate should be measured as a multi-level construct, over the life of a construction project. The study reports data collected in a longitudinal safety climate survey implemented during the construction of a food processing facility. An innovative and interactive survey data capture method was used. The data analysis was largely automated. Automatic report generation enables a fast response back to the construction project management team.

Findings: (stating whether they are interim or final): This paper reports the findings of the longitudinal safety climate study at three phases of the project. Multi-level analysis identified the WHS climate strengths and weaknesses in various subcontracted work crews engaged at the project.

Practical implications: (if applicable): The data enables a comparison of the safety climate between construction projects within a single organization, and between work crews (contractors) within a single project. Opportunities to use the system for benchmarking to improve performance are discussed.

Social implications: (if applicable) :This project addresses the significant problem of construction WHS by developing a customised safety climate data collection, analysis and reporting method.

Contribution to the field: The construction industry safety climate measurement tool is innovative in enabling the analysis of multi-level data – reflecting the hierarchical structure of construction project contractual relationships. The longitudinal application of the measurement approach also enables changes in safety climate to be monitored as project events unfold.

Keywords: construction, longitudinal analysis, multi-level analysis, safety climate.

INTRODUCTION

Agenda 21 of the 1992 Earth Summit in Rio established an action program for sustainable development. This was a key point in evolution of Corporate Social Responsibility (CSR), often used to measure an organisation's contribution towards the sustainable development through triple bottom-line factors.

In the Australian construction industry, large companies develop CSR in order to maintain an image of being a good corporate citizen (Petrovic-Lazarevic 2008: 01). Occupational Health & Safety is a critical element when reporting CSR in the

²⁸ ruwini.edirisinghe@rmit.edu.au

Construction Industry (Myers 2005: 783, Petrovic-Lazarevic 2008: 95). Petrovic-Lazarvic (2004: 02) states that by maintaining high occupational health and safety standards, a construction industry organisation can gain a competitive advantage. Also, globally there is a pressing need for positive Work Health and Safety (WHS) performance in construction industry due to the recorded high fatal and non-fatal accidents rates compared to the other industries.

The Australian construction industry employed 9% of the Australian workforce, however; over three years from 2008–09 to 2010–11, recorded construction workers' deaths from work-related injuries equated to 4.26 fatalities per 100 000 workers, which is nearly twice the national fatalities rate of 2.23. Over the same period, the Australian construction industry accounted for 11% of all serious workers' compensation claims. This accounts for 39 claims on average each day from employees who required one or more weeks off work because of work-related injury or disease. Also, in 2009–2010, the Australian construction industry recorded the highest number of compensated fatalities accounting to 21% of all compensated fatalities. Unsurprisingly, given this poor record, the Australian Work Health and Safety Strategy 2012-2022 establishes construction as a priority industry for improvement (Safe Work Australia 2012). The research presented herein aims to help address this national priority by improving a construction company's understanding of their WHS through advanced safety climate measurements.

The objective of this paper is to present the development of the automated multi-level safety climate benchmarking tool and its implementation in the construction projects.

SAFETY CLIMATE IN CONSTRUCTION PROJECTS

Safety climate models derived from safety climate surveys can provide in-depth information about the root causes of WHS problems. These models are considered to be useful diagnostic tools in contrast to using the traditional leading or lagging indicators alone (Lingard et al. 2013).

Safety climate is usually measured at an organization level. However, this is difficult to apply to construction projects due to the hierarchical nature of the construction industry, with multiple levels of activity, e.g. at the client, the principle contractor, and the sub-contractor levels, affect the overall safety climate of a project. Supportively, Kozlowski & Klein (2000) and Mearns (2009) argue that a single level perspective cannot effectively account for behaviour within organisations because they are multi-level systems. Research study reveals a significant variation in safety climate within a single organization (Zohar 2000), the quality of WHS implementation between organizational sub-units (Sparer and Dennerlein 2013) and between-group differences in WHS performance of subcontracted workgroups (Lingard et al. 2010).

Zohar (2000) proposes two levels of safety climate : organisation level and workgroup/sub-unit level and also argues that it is imperative to measure WHS at different levels within organizations (Zohar 2008). Subsequent studies confirmed that construction workers develop a shared set of perceptions of supervisory safety practices, and discriminate between perceptions of the organization's safety climate and the workgroup safety climate (Lingard et al. 2009). More recently Lingard, et al. (2012) investigated safety climate at a group level and found out that work groups whose members believed their supervisors to be strongly supportive of safety

experienced significantly lower lost time injury rates than other workgroups within the same construction project.

THE MULTI-LEVEL SAFETY CLIMATE INSTRUMENT

A safety climate measurement instrument was developed based on existing measures. It assesses construction workers' safety climate perceptions at multiple levels, including: 1) the safety priority of management (at both client and contractor levels); 2) supervisory safety leadership; 3) co-worker safety stewardship; and 4) individual safety performance. In the following, we discuss the different levels of the safety climate measured. The different levels are also depicted in Figure 1.

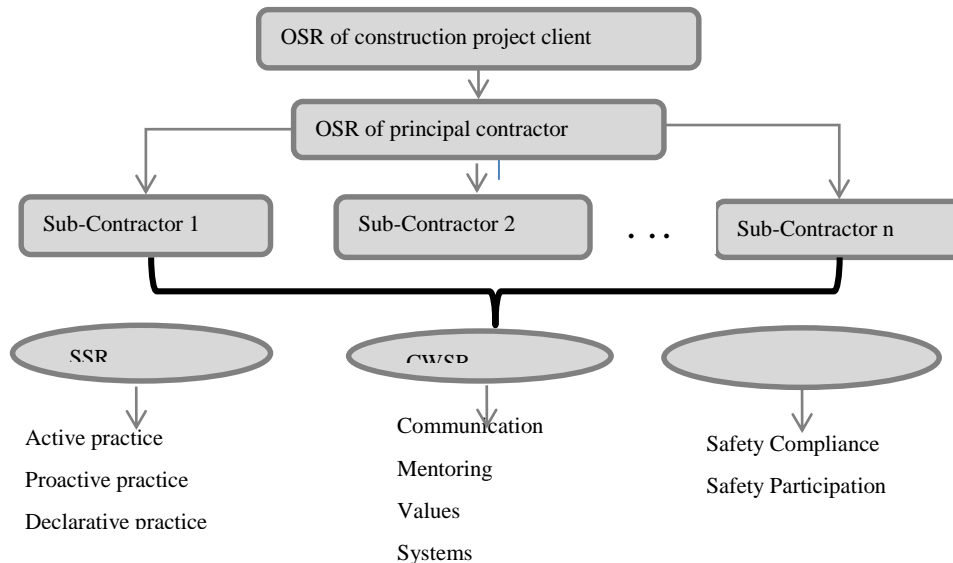

Figure 1: multi-level safety climate design

Workers' perceptions of Organizational Safety Response (OSR)

A key dimension of organizational safety climate is management commitment. Dedobbeleer and Béland (1998) reviewed 10 safety climate measurement instruments and found that management commitment is one of the two safety climate dimensions that are addressed across studies. Similarly, Flin et al. (2000) reported management commitment to be the most common theme of safety climate in their meta-analysis study. Management commitment can be reflected by workers' perceptions of management attitudes and behaviours in terms of safety, management concern for employees' well-being, importance assigned to safety by management, etc. (Dedobbeleer and Béland 1991, Huang et al. 2012). Zohar (2000) argues that the priority of safety should be a focal issue of safety climate. This suggests that management commitment should also be reflected by workers' perceptions of the relative priority management put on safety compared to other goals (e.g. speed, productivity). Zohar (2000) further argues that workers form the perceptions of safety priority through observing the concurrence between procedures and practices, and the patterns of managerial behaviours across different occasions. Therefore, management commitment is also concerned with the consistency in management safety responses.

In the context of the construction industry, the levels of influences of clients and principal contractors on construction workers' safety climate perceptions are different. Principal contractors are those who actually establish working schedules, determine working methods and manage construction processes. They are traditionally assigned

most of the obligations to plan for safety and risk control. Principal contractors have a more direct impact on WHS of construction workers than clients, due to their more direct contact with construction workers. While construction workers perceive principal contractors' safety response through observation of policies, procedures and practice patterns, they perceive clients' safety response through other visible symbols such as clients' involvement in safety management (Huang and Hinze 2006) , e.g. client's safety value/vision transmitted by contractors or posted on boards/banners on site, client's representative's behaviour and attitude regarding safety, client's reaction to unforeseen situations emerging in construction processes, clients' participation in safety activities, etc. As clients and principal contractors influence workers' perceptions of safety climate in different ways and at different levels, different measurement scales are used to measure client's organizational safety response and principal contractor's organizational safety response.

The general management commitment to safety scale developed for the UK Health and Safety Executive by Davies, Spencer et al. (1999) was adapted to measure workers' perceptions of client's organizational response. This scale contains nine items, reflecting client's overall priority given to safety and general concern for workers' WHS. Additionally, the global organizational-level safety climate measure developed by Zohar and Luria (2005) was adapted to assess principal contractor's organizational safety response. The measure constitutes of sixteen items, which are highly relevant to principal contractor's safety activities, and reflect the extent to which principal contractor shows genuine concern for safety and considers the priorities given to safety in different situations.

Workers' perceptions of their Supervisors' Safety Response (SSR)

Zohar (2000) suggests that workers form perceptions of supervisors' safety response by observing the overall pattern of supervisory practices, i.e. they assess whether supervisory practices converge into an internally consistent pattern regarding the relative priorities of safety versus efficiency goals. In light of this suggestion, the measure developed by Zohar and Luria (2005) reflecting a global safety priority/commitment factor was adapted to assess construction workers' perceptions of supervisor safety response. This measure includes fifteen items, which are further divided into three distinct dimensions of supervisory safety leadership, i.e. active practice, proactive practice, and declarative practice. Active and proactive supervisory safety practices reflect the difference between emphasising safety compliance with rules and exercising a commitment to safety improvement. An emphasis on compliance involves undertaking monitoring and control of the work to make sure that safe work procedures are followed and work is undertaken safely. An emphasis on safety improvement involves identifying opportunities to learn from past events and improve safety performance. Declarative practice reflects the public statements made by supervisors about safety. This reflects the expectations that supervisors establish for the way that work will be performed.

Workers' perceptions of the Co-workers' Safety Response (CWSR)

Safety climate researchers have recently taken an interest in the role played by co-workers in the formation of group safety climates. It is now acknowledged that co-workers exert a cultural/normative influence on safety in workgroups that has been overlooked by a previous safety climate research (Lingard et al. 2011, Brondino et al. 2012). Although supervisors and managers have formal power, co-workers have a

greater ability to influence safety climates, as they are perceived to be work task “experts”. Also, co-workers are closer in proximity to other workers and relatively larger in number than managers and supervisors. All these factors combine to make co-workers an important source of influence. Co-workers also provide feedback and advice about appropriate behaviour when there is tension between different job-role requirements, such as production and safety.

In this study, co-worker safety response is measured by Brondino et al.’s (2012) co-workers’ safety climate scale. This scale contains twelve items, which reflect four components, including: 1.) Values reflecting perceptions of the real importance given to safety by co-workers; 2.) Systems reflecting the importance co-workers assign to safety procedures, practices and equipment connected to safety at work; 3.) Communication reflecting the quality of communication processes concerning safety issues; and 4.) Mentoring reflecting the extent to which co-workers’ share safety knowledge and encourage one another to work safely.

Workers’ Perceptions of Individual Safety Performance (ISR)

Individual safety performance was measured by the safety behaviour scale provided by Neal and Griffin (2006). Six items are included in the scale, of which three items are related to workers’ compliance with safety rules and procedures, while another three reflect workers’ participation, e.g. voluntary behaviours in improving and promoting safety. Safety compliance and safety participation have been identified as separate components of safety related behaviour (Griffin and Neal 2000).

ADMINISTRATION OF THE SAFETY CLIMATE MEASURE

The research is conducted using a longitudinal research design; i.e. data was collected over the entire lifecycle of the construction project. Theoretical models of WHS across the project life cycle hypothesise that the ability to influence the project WHS is greatest at the beginning of the project and diminishes as the project progresses (Szymberski 1997). The longitudinal research design provides an opportunity to evaluate WHS in the different stages of the project lifecycle, thereby providing an important empirical evaluation of Szymberski’s ‘time/safety influence’ curve.

This research is designed to collect data in three phases at pre-determined intervals (e.g. quarterly). This provides a unique opportunity to better understand and evaluate the safety climate at different points which fluctuates (e.g. depending on schedule, pressure etc.) throughout the project life cycle. Thus, this longitudinal design enables managers to remain focused on safety and maintain a strong and positive safety climate throughout the entire life of the project. This paper reports the findings of the longitudinal study applied to a construction project in New Zealand.

DATA COLLECTION AND ANALYSIS

Data Collection

The study was undertaken at a construction project of a food processing facility in New Zealand. The research team visited the worksite to collect the first stage survey data. Participants for the study were invited by the project manager to participate in the survey at the site office. An independent local administrator was trained for subsequent data collection due to the practical limitations of researchers visiting the site for each of the quarterly survey administrations. The participants were asked 60 questions in total including the questions about demographic data which capture the

workgroup of the participants. The job categories include senior manager, project manager, site manager, foreman, leading hand, construction worker, graduate/engineer and student.

An innovative data capture method was used in survey data collection. The survey was administered using the 'TurningPoint' automated response ware system with power point slides showing the survey questions and 'KeePad' hand held devices for collecting the participants' responses. The data collection was anonymous. The survey was conducted in multiple sessions depending on the number of participants. Each session lasted for about one hour. Survey questions were projected onto a screen and the workers were asked to respond to the statement in each survey question using a 5-point scale ranging from '1 = Strongly Disagree' to '5 = Strongly Agree'. This method helped overcome eventual literacy issues of the workers. The interactive nature of the method also has the added advantage of getting workers more engaged in responding.

The response system was configured so that if a respondent presses an "out of range" value (e.g. 6), the response is not accepted. The administrator can monitor the number of responses captured for each question to determine the completeness of data as they are being collected. Hence, the advantages of this system include the completeness of data and minimisation of human errors (de Quiros et al. 2008) in data entry.

Data Analysis

The data analysis was automated using a tool developed using the Visual Basic programming language. The tool is called ASCC (Automated Safety Climate for Construction). It leverages the output of the TurningPoint software and adds multi-level and longitudinal data analysis. The functionality was implemented in a modular fashion. The design decisions were motivated by the need that researchers and client administrators have the necessary access to the outputs of the modular components. The tool is composed of a user interface, results analysis component and a reporting component. Figure 2 (a) illustrates the modular functional components of the user interface. Figure 2 (b) illustrates a segment of the results analysis component. The reports generated by the tool consist of two main forms: Tabular summary reports (shown in Figure 2 (c)) and Graphical visualization of results (shown in Figure 2 (d)).

The configuration module of the tool enables merging session data exported from "Turning Point" without any restriction (e.g. reuse Keepads across sessions, flexibility to skip a question if the respondents are not willing to answer are handled in the tool). Also, configuration data, such as the list of survey questions, data about negative survey questions are kept in a configuration file. The validity of the merged data is checked against missing data (if a question is skipped in one session), unanswered questions are highlighted through colour coding. Data preparation treats negative questions and sorts by groups. Data analysis module analyses the client's and contractor's organisational safety responses (SR) and sub scale SR and updates the results. The ASCC is currently semi-automated. Once the survey data is received, the report is generated automatically and recommendations are drawn by the research team. The final report is then sent back to the administration organisation. In future, the tool will be hosted online to enable real-time data upload and report download.

Configuration

Import Data

Configure

Data Preparation

ValidityCheck

Treat Negative Questions

SortByGroup

Data Analysis

Generate SR cross (All & groups)

Analyse Sub Scale data

Update Summary

2) The company would stop us working due to safety concerns, even if it means losing money 3.29

10) The site workers trust the company 3.51

11) management sometimes turn a blind eye to health and safety procedures/instructions/rules being broken 3.59

12) The company looks after site workers 3.87

Mean scores items measuring perceptions of Organisational Safety Response

Item	Mean Score
13) Management reacts quickly to solve the problem when told about safety hazards	3.80
14) Management insists on thorough and regular safety audits and inspections	3.80
15) Management tries to continually improve safety levels	3.79
16) It is hard to get all the equipment needed to do the job safely from	3.06
17) Management is strict about working safely – even when work falls behind schedule	3.75
18) Management quickly corrects any safety hazard – even if it's costly	3.69
19) Management provides detailed safety reports to workers (e.g. about injuries, near accidents)	3.32
20) Management considers contractor organizations' safety record before hiring them	3.27

(c) summary report

(a) user interface

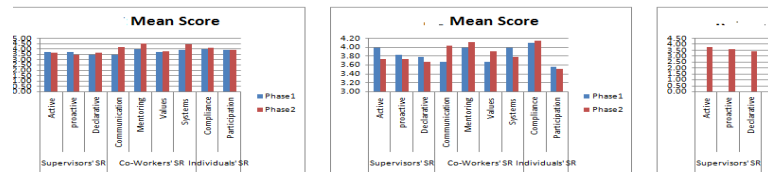

(b) results

	Active	Proactive	Declarative	Group Tol	Communi	Mentoring	Values	Systems	Group Tol	Complian	participat	Group Tol	Organisati
7B	2.00	2.25	2.33	3.95	4.05	4.17	3.77	3.38	3.64	3.16	1.00	1.00	1.00
5D	1.00	8.00	4.00	4.00	4.00	3.77	3.00	3.00	5.00	3.00	1.00	3.00	3.00
				3.95	4.05	4.17	3.77	3.38	3.64	3.16	3.12	3.41	3.54
p	Supervisor			Co-Worker			Individual			Organisati			
1	2.00	2.25	2.33	2.19	2.67	2.57	2.00	2.67	2.48	4.67	2.67	3.67	1.61
2	3.72	3.63	3.65	3.67	3.53	3.58	3.49	3.57	3.54	3.94	3.66	3.80	3.36
3	3.70	3.75	3.79	3.75	3.44	3.75	3.29	3.49	3.49	4.20	3.69	3.95	3.41
4	3.64	3.62	3.44	3.57	3.43	3.70	3.38	3.65	3.54	4.14	3.54	3.84	3.27
	3.67	3.64	3.65		3.45	3.64	3.36	3.52		4.08	3.65		
			3.66					3.487524			3.52		

Figure 2: ASCC software tool

Benchmarking Safety Climate Data

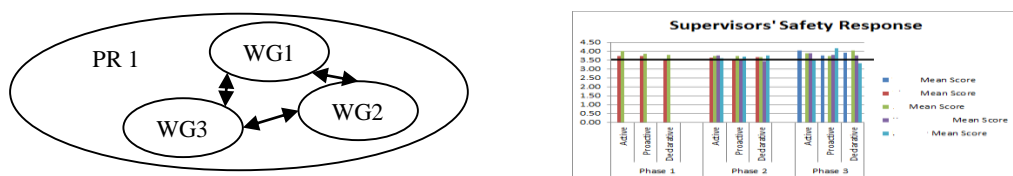

Figure 3: Benchmarking across workgroups

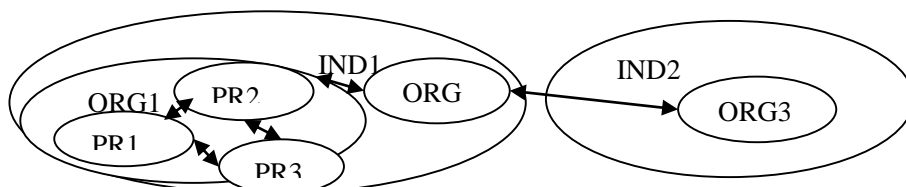

Figure 4: Potential for further Benchmarking

The data produced by safety performance indicators does not, in itself, improve safety (Wreathall 2009). However, benchmarking based on the collected data allows identifying areas for improvement. Benchmarking is defined as “an on-going process of measuring one company’s safety performance against that of competitors or organizations that are recognized as industry leaders” (Janicak 2010: 15).

The longitudinal comparison of data collected using the ASCC tool enables comparison and analysis of safety climate results across multiple phases of the same project. This also enables comparison of safety climate data of multiple workgroups (WG1, WG2 and WG3) of a project as shown in Figure 3. These workgroups include client organisation, principal contractor and sub-contractors. The comparison of climate of these work groups is enabled at supervisor, co-worker and individual levels.

When longitudinal data is available across multiple projects, the ASCC tool can be used in performance benchmarking of safety climate across multiple projects. This will be extended to a web-tool for benchmarking of organisations and industry sectors as shown in Figure 4: Benchmarking of safety performance across projects (PR1, PR2 and PR3), across organisations (ORG1, ORG2 and ORG3) of the same size and across industry sectors (IND1 and IND2) would be possible. This enables organisational benchmark, as well as national benchmark with in the industry and cross-industry for organisations to compare against.

RESULTS

The longitudinal safety climate surveys revealed that the proposed safety climate survey is a useful diagnostic tool for organizations to identify deficient areas that need improvements so as to improve safety. The surveys also uncovered that emphasis on safety varies over time throughout a construction project, especially when the project progresses to the completion stage with high production pressure. Table 1 provides example items to show the safety climate change trend over the project life.

Table 1: Example items showing safety climate change trend in the project

Example items for client’s organizational safety response (OSR)	Mean score		
	Stage1	Stage2	Stage3
I feel that the client are concerned about my general welfare	3.45	3.68	3.45
Example items for main contractor’s organizational safety response (OSR)			
Management of the principal contractor is strict about working safely – even when work falls behind schedule	3.24	3.62	3.12
Management of the principal contractor considers safety when setting production speed and schedules	3.38	3.52	3.18
Management of the principal contractor regularly holds safety-awareness events (e.g., presentations, ceremonies)	3.21	3.27	2.68

Example items in Table 1 were identified to have lower mean scores compared to the other items in the first stage survey. Based on the results, recommendations were made for project management to formulate intervention strategies to improve safety management in the identified deficient areas. Specifically, it was recommended to the client to increase visibility and participation in on-site safety activities to reinforce the client's interest and concern for workers' safety and welfare. The principal contractor was suggested to provide clear and unambiguous emphasis on safety in all circumstances, so the emphasis on safety is not perceived as being contingent on work

progressing to schedule. The principal contractor was also suggested to organize events to recognize/celebrate good safety performance. It is noticed that all the item mean scores increased in the second stage survey, suggesting that the recommendations derived from the first stage safety climate survey results were effective for safety management improvement. However, it is also noticed that all the mean scores of the example items declined a lot in the third stage survey. A cause analysis revealed that the third survey was conducted at the completion stage of the project. The hierarchy of competing goals may have changed with a greater emphasis being placed on 'getting the job finished on time'. The survey results indicate that workers are very sensitive to subtle changes in managerial emphasis, even when these changes are not consciously made. Based on the third stage survey results, the project management were recommended to seek opportunities to reinforce management commitment to safety, and include safety in discussion concerning project completion and progress to ensure that workers understand that these are compatible (rather than competing) project objectives.

DISCUSSION AND CONCLUSIONS

This project addresses the significant problem of construction WHS by developing a customised multi-level safety climate data collection, analysis and reporting method. The data enables a comparison of the safety climate between construction projects within a single organization, and between work crews (contractors) within a project. Challenge exists in obtaining descriptive statistics on the currently available substantially small samples. In the future, we plan to get additional data from other client organizations, so that a rich data set can be collected from their entire project. This would enable bench marking, allowing for comparisons to be made between projects within a single client organization, and between different client organizations.

The system is capable of generating (with automated report generation where applicable) a quick report to the clients hence client can provide timely feedback to the contractors and subcontractors. In future, the system will be hosted online.

REFERENCES

- Brondino, M., S. A. Silva and M. Pasini (2012). "Multilevel approach to organizational and group safety climate and safety performance: Co-workers as the missing link." *Safety Science* 50(9): 1847-1856.
- Davies, F., R. Spencer and K. Dooley (1999). Summary guide to safety climate tools. Offshore Technology Report, , Health and Safety Executive.
- de Quiros, A. C. B., R. Lopez, G. Aranda-Mena and P. Edwards (2008). Human reliability as a source of error in research. 24th Annual ARCOM Conference., A. Dainty. Cardiff, Association of Researchers in Construction Management: 687-696.
- Dedobbeleer, N. and F. Béland (1991). "A safety climate measure for construction sites." *Journal of Safety Research* 22(2): 97-103.
- Dedobbeleer, N. and F. Béland (1998). *Is risk perception one of the dimensions of safety climate*. London, Taylor & Francis.
- Flin, R., K. Mearns, P. O'Connor and R. Bryden (2000). "Measuring safety climate: identifying the common features." *Safety Science* 34(1-3): 177-192.

- Griffin, M. A. and A. Neal (2000). "Perceptions of safety at work: A framework for linking safety climate to safety performance, knowledge, and motivation." *Journal of Occupational Health Psychology* 5(3): 347.
- Huang, X. and J. Hinze (2006). "Owner's Role in Construction Safety." *Journal of Construction Engineering and Management* 132(2): 164-173.
- Huang, Y. H., S. K. Verma, W. R. Chang, T. K. Courtney, D. A. Lombardi, M. J. Brennan and M. J. Perry (2012). "Management commitment to safety vs. employee perceived safety training and association with future injury." *Accident Analysis & Prevention* 47: 94-101.
- Janicak, C. A. (2010). Safety metrics: Tools and techniques for measuring safety performance.
- Kozlowski, S. W. J. and K. J. Klein (2000). A multilevel approach to theory and research in organizations. *Multilevel theory, research and methods in organizations*. K. K. J. and K. S. W. J. San Francisco, Jossey-Bass: 3-90.
- Lingard, H., T. Cooke and N. Blismas (2009). "Group-level safety climate in the Australian construction industry: Within-group homogeneity and between-group differences in road construction and maintenance." *Construction Management and Economics* 27(4): 419-432.
- Lingard, H., T. Cooke and N. Blismas (2010). "Properties of group safety climate in construction: The development and evaluation of a typology." *Construction Management and Economics* 28(10): 1099–1112.
- Lingard, H., T. Cooke and N. Blismas (2011). "Coworkers' response to occupational health and safety: An overlooked dimension of group-level safety climate in the construction industry? ." *Engineering, Construction and Architectural Management* 18(2): 159-175.
- Lingard, H., T. Cooke and N. Blismas (2012). "Do perceptions of supervisors' safety responses mediate the relationship between perceptions of the organizational safety climate and incident rates in construction?" *ASCE Journal of Construction Engineering and Management*, 138(2): 234-241.
- Lingard, H., R. Wakefield and N. Blismas (2013). If you cannot measure it, you cannot improve it: Measuring health and safety performance in the construction industry. The 19th Triennial CIB World Building Congress, Brisbane, Queensland.
- Mearns, K. (2009). "From reactive to proactive – can LPIs deliver? ." *Safety Science* 47(4): 491-492.
- Myers, D. (2005). "A review of construction companies' attitudes to sustainability." *Construction Management and Economics* 23(8): 781-785.
- Neal, A. and M. A. Griffin (2006). "A Study of the Lagged Relationships Among Safety Climate, Safety Motivation, Safety Behavior, and Accidents at the Individual and Group Levels." *Journal of Applied Psychology* 91(4): 946-953.
- Petrovic-Lazarevic, S. (2004). Corporate Social Responsibility in Building and Construction Industry. Department of Management Working Paper Series ISSN 1327-5216, Monash University.
- Petrovic- Lazarevic, S. (2008). "The development of corporate social responsibility in the Australian construction industry, *Construction Management and Economics*." *Construction Management and Economics* 26(2): 93-101.
- Safe Work Australia (2012). "key statistics."

- Sparer, E. H. and J. T. Dennerlein (2013). "Determining safety inspection thresholds for employee incentive programs on construction sites." *Safety Science* 51(1): 77-84.
- Szymberski, R. (1997). "Construction project safety planning." *TAPPI* 80(11): 69-74.
- Wreathall, J. (2009). "Leading? Lagging? Whatever!" *Safety Science* 47.
- Zohar, D. (2000). "A group-level model of safety climate: Testing the effect of group climate on microaccidents in manufacturing jobs." *Journal of Applied Psychology* 85(4): 587-596.
- Zohar, D. (2008). "Safety climate and beyond: A multi-level multi-climate framework." *Safety Science* 46(3): 376-387.
- Zohar, D. and G. Luria (2005). "A multilevel model of safety climate: Cross-level relationships between organization and group-level climates." *Journal of Applied Psychology* 90(4): 616-628.

ADDITIONAL EVIDENCE OF THE SUSTAINABLE CONSTRUCTION SAFETY AND HEALTH (SCSH) RATING SYSTEM'S EFFECTIVENESS

Sathyanaraynan Rajendran²⁹ and John A. Gambatese³⁰

¹ *Department of Engineering Technologies, Safety, and Construction, Central Washington University,
Hogue Technology Building, Room 300K, Ellensburg, WA, 98926 USA*

² *School of Civil and Construction Engineering, Oregon State University, 101 Kearney Hall, Corvallis,
OR, 97331-2302 USA*

The Sustainable Construction Safety and Health (SCSH) rating system, developed in 2006, provides an opportunity to rate projects based on the importance given to construction worker safety and health, and the implementation of safety and health elements to achieve sustainable construction safety and health. The starting point for this paper is a previous study that involved validation of the rating system using 25 projects. Since then the SCSH tool has been disseminated to the industry with the help of the website www.sustainablesafetyandhealth.org. The primary objective of the study presented in this paper is to identify any change in the "level of implementation" of the rating system's 50 elements since the previous study eight years ago. This objective was met by comparing the SCSH rating system performance of the original 25 sample projects to the: (i) performance of 31 sample projects assessed through the website between 2011 and 2012; and (ii) performance of 33 sample projects assessed by the authors in 2013. A second research objective was to determine whether the SCSH rating system has helped construction stakeholders with their project safety and health planning process. This objective was met by soliciting information from construction safety professionals in the western United States. The results show that there was a significant change, both positive and negative, in the level of implementation of the rating system's 50 elements since the previous study. The elements associated with the design for safety concept showed significant improvement. The study reveals that the SCSH rating system has not been widely used by construction stakeholders. However, the SCSH website has received visitors from all over the world; many of them actively assess their projects. Innovative tools such as the SCSH rating system will help overcome the plateau in safety performance and lead to additional safety and health innovations.

Keywords: construction, injury free, prevention through design, safety, sustainability.

INTRODUCTION

Construction worker safety and health continues to be a serious concern for the construction industry around the world. In 2012, the U.S. construction industry, for example, accounted for more fatalities than any other industry (BLS 2013a). Although construction fatality rates have declined significantly in the last century, the past 15

²⁹ RajendranS@cwu.edu

³⁰ John.gambatese@oregonstate.edu

years have seen a plateau in industry-wide safety improvement (NSC 2011). Continuous safety research is needed to overcome the plateau.

Construction safety research has exposed the influence that owners, designers, constructors, and subcontractors have individually on construction worker safety and health (Hinze and Wiegand 1992; Huang and Hinze 2006; Jaselskis et al. 1996). The research reveals that all of the parties should strive to develop a positive safety culture and commit to creating an injury free work environment. The research indicates that injuries and accidents are influenced by and linked to a lack of comprehensive upstream planning. As a result, all parties on a project team, especially those on design-build and petrochemical/industrial projects, are increasingly working together to proactively address and manage safety and health early in the project development process and throughout the project lifecycle. To do so, the project team needs a comprehensive resource or tool that provides the ability to plan, evaluate, and manage worksite safety and health on a project during initial scoping and design phases. However, no comprehensive safety assessment tool or rating system was available that allows for evaluating and comparing projects across a common set of criteria. To close this gap, in 2006, the authors developed the Sustainable Construction Safety and Health (SCSH) rating system to evaluate construction projects based on their importance given to safety and health and the degree of implementation of safety and health elements (Rajendran 2006; Gambatese et al. 2006).

RATING SYSTEM DESCRIPTION AND BACKGROUND

The SCSH rating system contains safety and health elements organized into 13 major categories. Each category contains elements, which carry credits based on their effectiveness in preventing construction worker injuries/illnesses. The rating system consists of a total of 50 elements spread across the 13 categories. The elements are those implemented by owners, designers, and constructors to sustain worker safety and health on a project and from project-to-project. Those elements having a greater positive impact on construction worker safety and health carry a higher number of possible credits. If the element is implemented on a project, credits are earned for that element. The actual number of credits earned is based on the extent to which the element is implemented and the effectiveness of its implementation (Rajendran 2006).

Twenty five elements are “Required” elements for the project to be considered at a minimal level of safety and health management. The total number of possible credits that can be earned adds up to 100 credits. In order to receive the minimum level of certification, a project must fulfil all required elements to some degree. The project certifications are as follows: 1 star = All Required elements fulfilled; 2 stars = All Required elements fulfilled and 55-60 total credits; 3 stars = All Required elements fulfilled and 61-75 total credits; 4 stars = All Required elements fulfilled and 76-90 total credits, and 5 stars = All Required elements fulfilled and 91-100 total credits. The premise of the rating system is that a higher number of total credits received by a project would indicate a lower potential for incidents that lead to construction worker injuries, illnesses, and fatalities. A complete description of the rating system and its development is available in Rajendran 2006. A literature search did not reveal any similar project safety rating systems available for use in the construction industry.

The SCSH rating system was validated based on data from 25 construction projects, collected in 2006, and found to accurately represent the safety performance of large

projects. With respect to the 25 sample projects, the SCSH rating system provided a general representation of safety performance due to the presence of a negative correlation between the SCSH credits and the total recordable incident rate (TRIR). The SCSH rating system was shown to be an effective and proactive tool to develop and plan construction safety and health programs, and also measure the safety and health performance of construction projects. In addition to the validation, the authors documented the level of implementation of the SCSH elements at that time to understand industry trends (Rajendran and Gambatese 2007).

STUDY OBJECTIVES

Since the validation in 2006, the SCSH tool has been disseminated to the industry with the help of the website www.sustainablesafetyandhealth.org, which has attracted users from 108 countries, with some of them assessing their project performance by entering their project information online through the project assessment page. The SCSH website went live in May 2011. The rating system has received favourable publicity over the years, through various safety related trade journals and conference presentations across the United States.

The primary objective of the research presented in this paper was to identify any change in the level of implementation of the SCSH rating system's 50 elements since the previous study. The primary objective was met by comparing the SCSH rating system performance of the original 25 sample projects to the: (i) performance of 31 sample projects assessed through the website from 2011 to 2012; and (ii) performance of 33 sample projects assessed by the authors in 2013. The secondary objective was to understand if the SCSH rating system has helped construction stakeholders with their project safety and health planning process. The authors were also interested in identifying ways to improve the SCSH rating system. The secondary objectives were met by soliciting information about the SCSH rating system from construction safety professionals in the western United States. The authors also assessed the rating system's dissemination by monitoring the number of people who visited the website.

DATA COLLECTION AND ANALYSIS

The change in the level of implementation of the rating system was assessed by comparing SCSH element data of three sets of sample projects. The three sets of projects were collected at three different time periods: 2006, 2011-12, and 2013.

1. Sample projects from original study, hereafter referred to as "2006" data and projects: The 2006 data was collected through the development and distribution of an on-line questionnaire as the survey mechanism. The questionnaire contained three major sections requesting information on project demographics, safety performance, and the safety efforts identified in the SCSH rating system. Firms selected for the study consisted of ten firms with which the researchers had personal contact and which had expressed an interest in helping out with the research, and 20 firms that were randomly selected from the list of Top-400 Contractors as published by Engineering News-Record (ENR 2006). The respondents were asked to compile the survey information for as many projects as possible, limited to projects constructed between 2004 and 2006, or which were near completion at that time. Data on 25 construction projects from these firms was received.

2. Sample projects from a new study, hereafter referred to as “2013” data and projects: The 2013 data was collected using the 2006 questionnaire survey. Firms selected for the study consisted of firms with offices located across the United States with which the researchers had personal contact. The firms were not randomly selected. The respondents were asked to compile the survey information for one project, limited to projects constructed in the past five years (2009-2013) or which were near completion at that time. Data on 33 construction projects from these firms was received.
3. Data from the SCSH website, hereafter referred to as “2011-12” data and projects: An online SCSH calculator is available on the SCSH website. Many website visitors use the SCSH online calculator to assess their project’s performance according to the rating system. The project information entered by users between 2011 and 2012 was retrieved for the purpose of this paper. However, unlike the 2006 and 2013 sample projects, the online calculator did not solicit information about the project demographics and safety performance, rather, just the safety efforts identified in the SCSH rating system. Data from a total of 102 projects were retrieved from the SCSH website. However, some projects assessed online contained incomplete data. After a thorough review, data from only 31 sample projects were included in the study.

Simple descriptive and frequency statistical measures (average, range, and percent change) were used to evaluate and compare the SCSH performance between the three sample project datasets.

RESULTS

Sample Project Demographics

The project demographics section aimed at gathering information about the project size, type, and administration (see Table 1). The 2011-12 sample projects retrieved from the website did not provide project demographics. Some of the notable differences in project demographics between the 2006 and 2013 sample projects include number of subcontracts, employee count, and worker hours. More than 50% of the 2013 sample projects awarded less than 50 subcontracts. In terms of worker hours, 52% of the 2006 sample projects worked more than 200,000 hours compared to 24% for the 2013 sample.

SCSH Information

Based on the information provided by the respondents, the total number of SCSH credits was calculated for all of the sample projects. The average of the total SCSH credits for all the sample projects ranged from 30.3 to 66.6 credits. The 2013 sample had the highest average SCSH credits of 66.6, an increase of 3.4 credits from the 2006 sample. In addition, the 2013 projects implemented 79% of the “Required” SCSH elements, a 3% increase compared to 2006. Similar to the 2006 sample, the number of projects that were compliant with all “Required” elements was very low ($n = 2$). Even though the 2011-12 sample projects had the lowest average number of SCSH credits (9.6), four of the projects were compliant with all Required elements (see Table 2).

Project Safety Information

The study questionnaire (2006 and 2013 projects) requested that the responding firms provide information about the total number of OSHA recordable injuries sustained and the number of near misses recorded on each of the projects being reported. The

respondents were also asked to provide the total number of work hours that were worked on the projects. Based on these amounts, the total recordable injury rate (TRIR) was calculated for the sample projects (see Table 2). Please note that information required to calculate TRIR was not available for the 2011-12 sample projects (from the website). The TRIR for the 2013 projects returned a low TRIR of 1.61 compared to 2.17 for the 2006 sample. It should be noted that the average SCSH credits increased for the 2013 sample.

Table 1: Summary of Project Demographics Comparison between 2006 and 2013

Demographic	2006 (1)	2013 (2)	Diff. (2) - (1)
Delivery Method:			
Design-Bid-Build (DBB)	28%	39%	11%
Design-Build (DB)	28%	18%	-10%
Construction Mgr./General Contractor (CM/GC)	36%	6%	-30%
Others	8%	36%	28%
Funding:			
Private	56%	42%	-14%
Public	44%	55%	11%
Unknown	0%	3%	3%
Union Status:			
Open	48%	30%	-18%
Union	52%	52%	0%
Open/Union	0%	15%	15%
Unknown	0%	3%	3%
Facility Type:			
Education	12%	12%	0%
Industrial	16%	24%	8%
Medical	20%	3%	-17%
Residential	32%	12%	-20%
Transportation	8%	21%	13%
Others	12%	27%	15%
Number of Participant Firms:*	12	28	(-16)
Number of subcontracts:			
Less than 50	36%	88%	52%
More than 50	52%	3%	-49%
Unknown	12%	9%	-3%
Number of employees:			
Less than 100	20%	36%	16%
Between 100 and 500	36%	52%	16%

More than 500	28%	9%	-19%
Unknown	16%	3%	-13%
Worker hours:			
Less than 100,000	20%	49%	29%
Between 100,000 and 200,000	24%	9%	-15%
More than 200,000	52%	24%	-28%
Unknown	4%	18%	14%

**Number of unique contractors contributing to the sample size*

Table 2: Summary of SCSH Credits and Safety Performance

Item Description	2006	2011-12	2013	Diff.	Diff.
	(1)	(2)	(3)	(2)-(1)	(2)-(3)
Sample size (# of projects)	25	31	33	6	8
Average # of SCSH credits	63.2	30.3	66.6	-32.9	3.4
Minimum # of credits earned	28.2	9.6	20.6	-18.6	-7.6
Maximum # of credits earned	91.5	46.7	95.8	-44.8	4.3
# of proj. with all Reqd. elements	1	4	2	3	1
Avg. % of Required credits fulfilled	76%	74%	79%	-2%	3%
Avg. # of Required credits fulfilled	19.0	18.6	19.9	-0.4	0.9
Total work hours	41,690,865	--	7,679,303	--	-34,011,562
Average total project work hours	1,737,119	--	274,261	--	-1,462,858
Minimum # of hours worked	9,500	--	1,320	--	-8180
Maximum # of hours worked	30,419,929	--	1,620,829	--	28,799,100
Total recordable injury rate (TRIR)	2.17	--	1.61	--	-0.56
Near miss rate	1.85	--	7.68	--	5.83

SCSH Performance Comparison

Performance of SCSH Categories

The level of SCSH rating system performance between the three sets of sample projects was first compared using the 13 main categories. To simplify this comparison, the researchers used a metric called “SCSH index” which is calculated as follows:

$$SCSH\ index = \frac{\text{Average credits for each SCSH category}}{\text{Maximum possible credits for that category}}$$

An SCSH index of 1.0 indicates that all the projects were 100% complaint. Table 3 presents and compares the SCSH index for the 13 SCSH categories for the three data sets. The table also presents the difference in SCSH index between the three sets of sample projects using 2006 as the benchmark. The “accident investigation and reporting” category returned the largest SCSH index (0.93) among all categories for all three datasets. The 2011-12 sample projects returned the lowest SCSH index in all

categories, indicating extremely low compliance with the SCSH elements. Comparing 2006 and 2013, some categories showed an improvement (e.g., Safety resources) while the performance of some categories declined (e.g., Employee involvement). The “safety and health planning” category showed a significant improvement with its SCSH index increasing from 0.56 to 0.72 between 2006 and 2013. The training and education category remained stable with the only SCSH index of zero. It was puzzling to notice the employee involvement category’s SCSH index dropped from 0.86 to 0.65.

Table 3: SCSH Project Performance Comparison under Different SCSH Categories (Ratio of Average Credits/Maximum Possible Credits)

Element Category	2006 (1)	2011-12 (2)	2013 (3)	Diff. (2)–(1)	Diff. (3)–(1)
Project Team Selection	0.43	0.29	0.40	-0.14	-0.03
Safety and Health in Contracts	0.50	0.32	0.58	-0.18	0.08
Safety and Health Professionals	0.80	0.35	0.66	-0.45	-0.14
Safety and Health Commitment	0.75	0.35	0.72	-0.40	-0.03
Safety and Health Planning	0.56	0.30	0.72	-0.26	0.16
Training and Education	0.70	0.34	0.70	-0.36	0.00
Safety Resources	0.28	0.23	0.45	-0.05	0.17
Drug and Alcohol Program	0.75	0.35	0.84	-0.40	0.09
Accident Investigation and Reporting	0.73	0.34	0.93	-0.39	0.20
Employee Involvement	0.86	0.22	0.65	-0.64	-0.21
Inspection	0.86	0.33	0.70	-0.53	-0.16
Safety Accountability and Perf. Measurement	0.75	0.29	0.64	-0.46	-0.11
Industrial Hygiene and Health Practices	0.41	0.22	0.57	-0.19	0.16

Additional assessment was made comparing the SCSH categories based on the percentage of projects that contain the SCSH elements in the category (see Table 4). In 2006, 72% of the sample projects did not have a task-based hazard database as part of their project safety program. However, in 2013, only 54% of the projects did not have the database, a significant improvement over the last eight years. Categories such as safety and health in contracts, safety and health commitment, safety and health planning, training and education, employee involvement, and inspection continued to be part of all sample projects to some degree. The level of implementation of industrial hygiene practices showed an improvement in 2013.

Table 4: SCSH Project Performance Comparison under Different SCSH Categories (% of projects that contain the elements in the category)

Element Category	2006	2011-12	2013	Diff.	Diff.
	(1)	(2)	(3)	(2)–(1)	(3)–(1)
Project Team Selection	92%	94%	88%	2%	-4%
Safety and Health in Contracts	100%	100%	100%	0%	0%
Safety and Health Professionals	100%	94%	94%	-6%	-6%
Safety and Health Commitment	100%	97%	100%	-3%	0%
Safety and Health Planning	100%	90%	100%	-10%	0%
Training and Education	100%	87%	100%	-13%	0%
Safety Resources	28%	42%	46%	14%	18%
Drug and Alcohol Program	88%	68%	97%	-20%	9%
Accident Investigation and Reporting	100%	74%	97%	-26%	-3%
Employee Involvement	100%	81%	100%	-19%	0%
Inspection	100%	74%	100%	-26%	0%
Safety Accountability and Perf. Measurement	96%	77%	97%	-19%	1%
Industrial Hygiene and Health Practices	80%	77%	100%	-3%	20%

Performance of SCSH Elements

The level of implementation of the elements was compared between the three samples of projects by asking the following questions: (1) “What are the most commonly implemented SCSH elements in the construction industry?” and (2) “What are the least implemented SCSH elements in the construction industry?” A list of the SCSH rating system’s 50 elements along with the percentage of projects that implemented those elements was created to identify the “most” and “least” implemented elements among the sample projects. Any element that was implemented by only 25% or less of the projects was considered as one of the least implemented elements, and elements implemented by more than or equal to 75% of the projects were termed as the most commonly implemented elements. The performance of the 2006 sample projects was used as the benchmark so that the 2011-12 and 2013 sample projects can be compared to the standard set by the 2006 sample.

Most of the elements that were not implemented in 2006, such as safety checklist for designers, were associated with the designing for safety concept. It was interesting to note that all of these elements showed significant improvement in 2013. For example, in 2006, only 28% of the sample projects utilized the design for construction worker safety concept while in 2013, 61% of the sample projects utilized this concept. It is an extremely positive sign that the industry is gradually recognizing design for safety as a viable intervention to improve construction worker safety and health.

During the initial research study and the latest survey, one question of particular interest that related to the rating system’s structure was whether to have the 25 mandatory SCSH elements required as part of the rating system. In 2006, only one (4%) of the 25 projects fulfilled all of the 25 required elements. Similarly, only two (6%) of the 33 projects and 4 (13%) of the 31 projects fulfilled all of the 25 required elements for the 2013 and 2011-12 datasets respectively. This result leads one to

question the task. At the project level, pre-task planning meetings are considered critical to success; an improvement of this element is welcoming.

On the other hand, several elements' 2013 performance declined compared to 2006. The project accountability and responsibility element returned a low 61% in 2013, and the GC full-time safety representative was at 70%. The overall project size of the 2013 sample was smaller compared to 2006, which could be a factor contributing to the decrease in full-time safety representative presence. Typically, full-time safety representatives are only required on large projects. In addition, the safety training for field supervisors returned a low 73% in 2013 compared to 96% in 2006. This could be attributed mainly due to recession as many companies have reduced training budgets.

Factors that Impact SCSH Performance

The researchers attempted to identify the impact of project size on a project's SCSH level of implementation. Project size was defined in terms of total project worker hours and SCSH performance was defined in terms of total SCSH credits. The correlation between the SCSH credits and project worker-hours was measured by calculating the correlation coefficient "R", which gives a measure of reliability of the linear relationship between the SCSH credits and the worker hours. If the correlation coefficient is close to +1.0, then there is a strong positive linear relationship between x and y. In other words, if x increases, y also increases. The R-value was found to be 0.50 and 0.56 for 2006 and 2013 sample projects respectively, showing moderate correlation between worker-hours and SCSH credits.

SCSH RATING SYSTEM DISSEMINATION

The extent to which dissemination of the SCSH rating system has occurred was measured through an on-line survey of construction safety professionals and by monitoring the number of people who visited the website.

Safety Professionals Input

As part of the 2013 questionnaire survey, the respondent firm's safety professionals were asked the following two questions to understand the level of dissemination and familiarity with the SCSH rating system:

Have you used the SCSH rating system on the project or for previous projects? If so, did you change the safety program on the project based on the SCSH website? Do you have any suggestions for improving the website?

Please review the safety elements included in the SCSH website. Are there any safety elements which you think are especially effective on projects which are **not** covered in the SCSH rating system?

Overall responses to these questions were fair. Only twenty six safety professionals responded to the first question, of which 25 professionals (96%) responded that they have not used the SCSH rating system on the project or for previous projects. This indicates that the SCSH rating system has not been disseminated well in the industry. However, fourteen safety professionals responded to the question, "Are there any safety elements which you think are especially effective on projects which are **not** covered in the SCSH rating system?" The responses received are listed below:

- Cannot think of any suggested changes (or) none (n = 5)
- Good reflection on the elements in our safety program. No addition needed.
- It would be a good way to increase the safety performance of subcontractors.

- “Innovation credits. Round the credits to make it look like LEED,” and “Add some innovation points like in LEED.”
- Combine elements 9.1 (Accident and Near Miss Investigation) and 9.2. (Accident and Near Miss Investigation with pre-task/JHA).
- Combine elements 11.1 (Safety Inspections) and 11.2 (Safety Violations Identified and Corrected).
- Include duty of owners and how owners are actively involved.
- It can overburden specialty contractors that don't experience all of the hazards. Smaller specialized contractors can't achieve this recognition.
- Safety professional involvement: How often a safety field manager is on-site. How many safety managers are on the project?
- To improve some of the questions, the questions could be more detailed and require more extensive answers.

SCSH Website Traffic

The extent to which dissemination has occurred was also measured using the *Google Analytics* tracking system by monitoring the number of people who visit the SCSH website and their geographical location. Between May 2011 and December 2013, the website had 4,763 visits (approximately 154 visits per month), of which 3,542 were unique visitors (114 per month). In terms of the geographical location, users from 108 countries visited the website. In terms of distribution, 66.7% of the visitors were from the United States, followed by United Kingdom, Malaysia, India, and Canada.

CONCLUSIONS AND RECOMMENDATIONS

The primary objective of this research was to assess the change in the level of implementation of SCSH rating system's 50 elements since the previous study eight years ago. This objective was met by a simple analysis comparing the SCSH rating system performance of the original 25 sample projects to the: (i) performance of the 31 projects assessed through the website in 2011 and 2012, and (ii) performance of the 33 sample projects collected in 2013. In addition, the extent to which the website's dissemination has occurred was measured through an on-line survey of construction safety professionals, and by monitoring the number of people who have visited the website. The following conclusions can be made based on the analysis:

- There has been a change in the level of implementation of the rating system's 50 elements, both negative and positive, since the 2006 study.
- The elements associated with the design for safety concept showed significant improvement compared to the previous study.
- Some of the most commonly implemented elements based on 2013 projects include: top management commitment, toolbox meetings, drug and alcohol testing program, and pre-task planning.
- The number of projects that fulfilled all of the 25 required elements criteria continued to be low. Including all as required elements should be reconsidered.
- The project size measured based on worker-hours has an influence on the level of performance of a project as measured by total SCSH credits.
- The majority of the stakeholders in the construction industry have not used the SCSH rating system on their projects. However, it is evident that many are actively visiting the website.
- The SCSH rating system could be improved by including innovation credits.

Based on the study results, changes are likely needed to increase use of the SCSH rating system in the future. Its limited use may be due to its structure and complexity, or the absence of an influential organization such as the American Society of Safety Engineers (ASSE) or Occupational Safety and Health Administration (OSHA) actively promoting use of the rating system. Modifications to the rating system, such as combining some elements, adding new elements, and expanding the detailed descriptions about each element, are recommended by the study participants. In addition, encouragement from an influential industry organization such as ASSE and/or OSHA to use the rating system as a safety benchmarking tool would likely increase its use. Further research should be conducted to improve the rating system structure, credits, and inclusion of additional elements. In addition, more research with a large sample size of just transportation type projects should be conducted to test the validity of the rating system for this type of projects.

REFERENCES

- BLS (2013a). Census of fatal occupational injuries charts, 1992-2012, available at <http://www.bls.gov/iif/oshwc/foi/cfch0011.pdf>. (Accessed 7 October 2013).
- BLS (2013b). State occupational injuries, illnesses, and fatalities, available at <http://www.bls.gov/iif/oshstate.htm#WA> (accessed 7 October 2013).
- ENR (2006). "Top 400 contractors." Engineering News-Record, www.enr.com. (Accessed June 2006)
- Gambatese, J.A., Rajendran, S., and Behm, M.G. (2006). "Building toward sustainable safety and health." Proceedings of the ASSE Professional Development Conference, Seattle, WA, June 11-14, 2006.
- Gambatese, J.A., Rajendran, S., and Behm, M.G. (2007). "Green design & construction: Understanding the effects on construction worker safety and health." Prof. Safety, J. of the Amer. Soc. of Safety Engrs., 52(5), 28-35.
- Hinze, J. and Wiegand, J. (1992). "Role of designers in construction worker safety." Journal of Construction Engineering and Mgmt., ASCE, 118(4), 677-684.
- Huang, X. and Hinze, J. (2006). "Owners role in construction safety: Guidance model." Journal of Construction Engineering and Mgmt., ASCE, 132(2), 174-181.
- Jaselskis, E.J., Anderson, S.D., and Russell, J.S. (1996). "Strategies for achieving excellence in construction safety performance." Journal of Construction Engineering and Management, ASCE, 122(1), 61-70.
- NSC (2011). Injury Facts, 2011 Edition. National Safety Council, Itasca, Illinois.
- Rajendran, S. (2006). "Sustainable construction safety and health rating system." Doctoral dissertation, Oregon State University, Corvallis, OR.
- Rajendran, S. and Gambatese, J.A. (2007). "Sustainable construction safety and health rating system: A feasibility study." Proc. of the 2007 ASCE Construction Research Congress, ASCE, Grand Bahama Island, Bahamas, May 6-8, 2007.
- Viera, A.J. and Garrett, J.M., 2005. "Understanding interobserver agreement: The kappa statistic." Family Medicine, 37(5), 360-363.

FROM ZERO ACCIDENTS TO WELL-BEING AND POSITIVE HEALTH

Valentina Villa³¹, Amarjit Singh² and G.M. Di Giuda³

¹ *PhD, MEng, ABC Dept., Politecnico di Milano, Italy*

² *Professor, Dept. of Civil Engineering., Univ. of Hawaii, Honolulu, HI 96822 USA*

³ *Assistant Professor, ABC Dept., Politecnico di Milano, Italy*

This research extends the concept of Health and Safety (H&S) in the construction industry to the entire construction process in any country or region. It expands occupational safety aims from beyond zero accidents into increasing workers' productivity by improving their health, safety, and well-being, and into creating new H&S cultural values in organizations. The following features define this concept's approach:

1. All stakeholders, workers, and personnel on the project are responsible for H&S at work.
2. Each person on the project must be treated with care and respect because they contribute value to the construction process.
3. There are false beliefs that increasing the safety of workers means increasing costs, and that improving the H&S of workers affects productivity adversely.
4. Ensuring well-being creates an enjoyable work environment that increases productivity and improves occupational safety.
5. Worker involvement in H&S plays a fundamental role in improving the work process and analyzing safety, especially since no one knows the work better than the workers themselves.
6. Clients must procure contractors, and contractors must procure the services of subcontractors, based on their H&S record rather than only the cheapest price quote. Improved measures for management awareness, cooperation among all stakeholders and site personnel, health counselling, and positive health reinforcement measures can enhance the workers' health at the construction site. H&S is often considered independently from other work operations on the construction site. However, H&S involves all people at the site, all stakeholders, the families of the workers, and society at large. Only through promoting a culture of occupational safety and increasing H&S awareness can society hope to attain not only zero accidents, but also overall improved health.

Keywords: construction safety, cultural values, health and safety, occupational safety, sustainable productivity.

INTRODUCTION

The organizational model that has been used over the previous century for industrial production is not compatible with the "production system" associated with the construction industry. However, the construction industry worldwide is increasingly becoming linked to the industrial production model based on Taylor's principles,

³¹ vale.villa@gmail.com

namely (Taylor 1997):

1. Analyzing the characteristics of the job to be done;
2. Creating the worker's prototype suitable for that type of job; and
3. Selecting the ideal employee to train in the company.

With this approach, Taylor proposed identifying for each worker a suitable job to achieve these objectives.

Currently in the construction field, construction tasks are now distributed between many specialized companies as determined by the system shown above. In fact, now companies are increasingly identified as either contractors, who work on administrative organization and resource management, or contracting companies, who accomplish the physical work. Otherwise, with critical socio-economic factors developed in the last century, the 'division of labor' in manufacturing succeeded because the factory and the assembly line allowed for the specialization of tasks.

Nevertheless, this production model does not work well in the construction field. Reports and interference created in the overlap of operations must also be considered in occupational safety planning not only by the managers, but also directly by the workers (Di Giuda et al. 2010). Whereas the *passive* systems of safeguards (i.e., the machine is equipped with protections) contribute to a qualitative leap in the management of safety in the industrial sector, the *active* development of knowledge of proactive systems contributes to sustainable occupational safety in the construction industry.

Therefore defining 'health' as the absence of visible, self-reporting indicators can overlook significant dangers. Proactive systems focus on accidents and the way they are responded to. What causes more accidents: unsafe actions or unsafe conditions? All accidents are caused by both factors and have conditional and behavioral elements. The two major focuses of proactive safety are on improving conditions and on improving behaviors (Galloway 2012).

Thus, there is always a combination of behaviors and conditions. However, this paper goes beyond traditional safety management, which has been based on engineering and design, rules and procedures, supervision, training and legal compliance. This paper focuses on the participation of all workers in the construction process and on improving the well-being and organizational culture of Health and Safety (H&S) in the construction site. This paper analyzes six points which should serve as the starting point for initiating an occupational safety culture beyond zero accidents for the comfort and sustainable well-being of all workers from a "human cost" point of view. These six points are: (1) Distribution of responsibilities among workers, (2) respect for all workers, (3) safety vs. productivity, (4) workers' welfare, (5) workers' involvement in safety, and (6) incentivizing firms for incorporating safety.

DISTRIBUTION OF RESPONSIBILITIES AMONG WORKERS

The responsibilities for the safety are mainly delegated to the positions of the builder – as owner and manager of the company – the safety coordinator and the project manager. They are responsible for organizing safe work practices, conducting economic assessments, and safety planning. However, maintaining a safe working environment largely depends on the workers themselves. On a construction site, the workers, i.e., people who work at the yard every day, have direct responsibility for the proper use of PPE (Personal Protective Equipment) and the reporting of critical or

dangerous situations. It is unclear why the workers are not involved in coordination meetings; too often they are only considered to be the "work force." In fact, every worker has responsibilities vis-à-vis safety, commensurate with their level of education and skills, so that a sufficient degree of coordination is achieved at every level. The first step must be to identify a clear hierarchy inside the building site, including all staff. Everyone should be aware that he or she is part of a system and know at what level he or she is located within it. Situated next to the management scheme should also be a detailed WBS (Work Breakdown Structure) of safety work, identifying exactly every task involved on site. Therefore, each level of that WBS needs to be assigned to the corresponding manager responsible for both quality and safety. Every worker is then responsible for the safety of his or her operating team.

In this way, the WBS enhances the involvement, responsibility, and awareness of each worker's stake in the construction process. This approach can improve not only the welfare of workers but also focus the teams' target and commitment to perform most effectively with all requisite care.

The mode of presentation of the organization team will stimulate collaboration between the workers and the management team and the involvement in the execution process (Health and Safety Executive 2007). By doing this, employees will understand the stakes involved, manage the different aspects of safety in their area, and feel responsible for themselves and their coworkers.

RESPECT FOR ALL WORKERS

As described in the previous paragraph, hierarchies importantly provide a detailed organization of the work for the management of respective responsibilities. However, a downside of hierarchies is that most of the lower-level people who contribute to the work are too often unconsidered.

Often those who abuse their superior statuses in hierarchies can add stress through the timing and costs of construction. Main psychosocial risk factors include time pressure/work load, lack of autonomy and communication, checks by superiors, violence, harassment, and discrimination (EU-OSHA 2011). However, considering the status of workers at all levels means involving them in the criticism and praise for the work done, discussing with them about work not meeting expectations, and getting them to agree on the modalities of executions of the work. Respecting the workers means considering their manual experience (often higher for engineers and managers) and being able to increase it with new knowledge. Relying on older methods to execute work often makes some workers and managers lose sight of new approaches or different modes of execution.

There is also a blind spot in how work is assessed and evaluated. While workers can take pride in a job well done, rewarded with appropriate respect and dignity, quality management systems providing evaluation forms for customer satisfaction never consider the degree of well-being, involvement and satisfaction of *employees and workers*. Assessing employee satisfaction is important if a company aims to progress and improve.

Therefore, in order to gather feedback to improve the work environment and the workers' welfare, it is the authors' recommendation that an investigation about any problems observed or employees' suggestions for improvement should be conducted at the end of the contract. A useful approach would be to have quality management

systems (QMS) determine the level of worker satisfaction as it already does for customers. The QMS should include foremen and all other workers. The working manager should agree with the control data and verification data sheets of processes, and all workers should see them before entering the building site.

This new process would involve those directly responsible for the criteria behind judging the work, for the criteria accepting the workmanship and required quality, and for the criteria measuring acceptance and project completion level. Seemingly far removed from the safety aspect, this amended process would allow workers to participate in a more complex project. Gathering all workers' opinions would also record the overall well-being that this workplace has helped to create.

Therefore, the participation of workers constitutes an important part of managing H&S. Managers do not have solutions for all H&S problems, while the workers and their representatives have the depth and breadth of experience and extensive knowledge concerning the way the work is done and its consequences. Therefore, managers and employees must work closely together to find joint solutions to common problems.

The following is the resulting diagram:

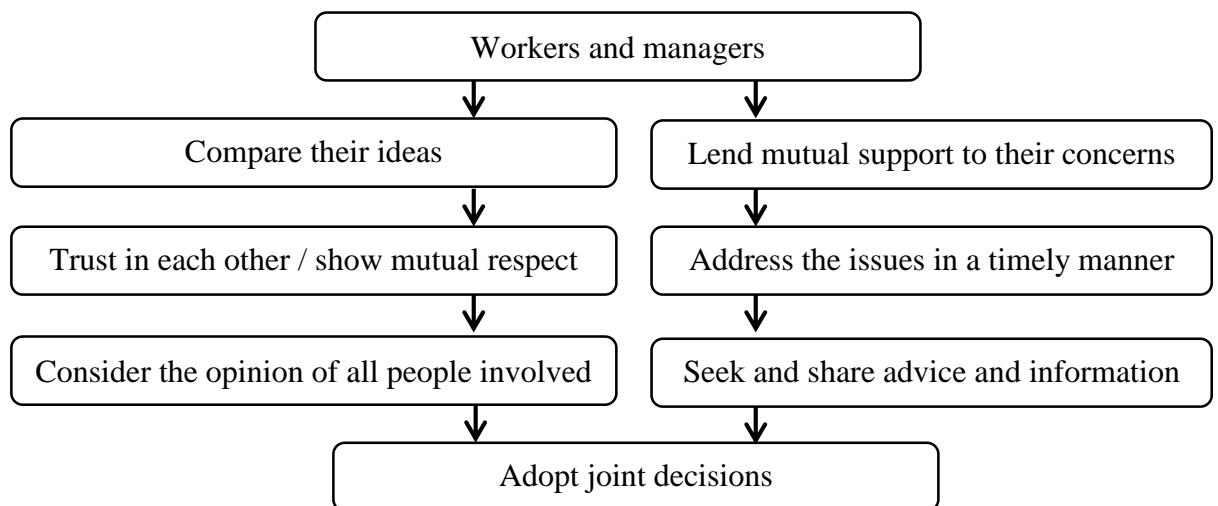

Figure 1: Diagram for cooperation between workers and managers

SAFETY COSTS VS. PRODUCTIVITY

Many people believe that increasing the health and safety will increase costs. However, this belief is not true, because the savings from promoting safety generate more profit. As can be seen below, governmental-level data from the International Labor Organization (ILO), Italy, and the European Union overwhelmingly support this. Making profits at the cost of safety is comparatively easy to conceptualize, but is socially unacceptable.

It has been estimated that each year, approximately 270 million work accidents and 160 million occupational diseases happen in the world, resulting in an economic cost (due to health care costs, compensation, loss of productivity, etc.) equal to an average of 4% of world Gross Domestic Product (GDP), or about a trillion dollars worldwide (ILO 2012, INAIL 2009). In Europe, the sum of work accidents and occupational

diseases involve an annual expenditure of 3-4% of GDP, or about € 200-300 billion (EU-OSHA 2013, INAIL 2009). In Italy, for instance, it is estimated that the annual cost of the lack of prevention of work accidents and occupational diseases is equal to 3% of the national GDP, or about € 44 billion (INAIL 2009).

Each year, 4.9 million accidents worldwide produce more than 3 days of absence from work per person affected (i.e., more than three days of worker absence is compensated by accident insurance and not by the employer, so this cost is borne by society). For most countries, the cost of accidents at work and occupational diseases amounts to between 2.6% and 3.8% of their GDP. The cost burden affects not only individual companies but also the national economy. National economies and companies that have introduced better standards of H&S tend to have lower costs associated with accidents (Di Giuda et al. 2012).

Moreover, the above estimates do not enable calculating the "human" costs – those relating primarily to disability and death – which are nonetheless incalculable for the individuals and their families. When people talk about accidents or illnesses, they must understand that they are often speaking of real tragedies that affect not only workers but also their families. Often the same injuries or illnesses impact the entire community, which has to provide assistance to workers and their families.

The dimension of indirect costs is in fact inversely proportional to the severity of the injury, i.e., the less severe the injury, the greater the relation of indirect costs with respect to the direct ones (up to 4 or 5 times higher). Direct costs are uniquely associated with the cost of accidents, injuries and occupational disease, and include the following (Mossink and De Greef 2002):

- Medical costs for the injured (hospital costs, medical consultations, rehabilitation, medicines);
- Integration of wages not covered by insurance;
- Damage caused to the property (machinery, equipment, buildings, vehicles);
- Disruptions to production caused by accidents;
- The injured worker's loss of productivity after returning to work.

Indirect costs are not uniquely associated with the cost object and include the following (Mossink and De Greef 2002):

- Costs of reduced productivity of the labor force due to the high frequency of accidents or labor strikes;
- Costs of overtime needed to recover the work time lost as a result of the injury and accident;
- Cost of investigations, compilation of records, and reports with the supervisory authorities;
- Cost of replacing a worker who quits a job, which involves recruiting and retraining, as high staff turnover usually occurs in unsafe workplaces.

For example, in Switzerland, workers who worked on ladders participated in a prevention program which included training that cost 2.2 million USD. After the first year, accidents were reduced by 500 cases. As one accident from falling from a ladder can cost 8,600 USD (from insurance, administrative processing time, and lost production), the reduction of 500 injuries likely saved an estimated 4.3 million USD (ILO 2012).

Therefore, a safe and healthy working environment highly benefits companies,

especially those in the construction industry. An effective H&S system can provide economic benefits. In fact, every construction project must be completed in the time agreed, must reach a certain level of quality, and must fall within the estimated budget, all while avoiding injuries and accidents. A good H&S policy can contribute to the success of these activities, but also could add a new element: the improvement of the welfare and well-being of workers.

Finally, statistically the construction industry is one of the sectors with the highest number of accidents at work. It is estimated that the construction sector in the EU produces € 902 billion in profit per year; accidents and occupational weight make up 8.5% of total project costs. Thus, the existence of low OSH standards in construction could result in a cost of more than € 75 billion a year (equivalent to almost € 200 per inhabitant) (EU-OSHA 2011).

TAKING CARE OF THE WORKERS' WELFARE

One useful definition acknowledges that well-being is “a summative concept that characterizes the quality of working lives, including occupational safety and health (OSH) aspects, and may serve as a major determinant of productivity at the individual, enterprise and societal levels” (Schulte and Vainio 2010, EU-OSHA 2013)).

Each firm can assess its success or failure not only by profit and loss accounts but also on the degree of employee involvement and satisfaction. Many people work not only to earn an income, but also to be productive and to develop intellectual or manual skills. Working ideally involves passion and dedication and consequently results in satisfaction for the work completed. Without these work motivators, workers merely become a fungible workforce without a strong identity. But too often the purpose of work has been oversimplified to just “making money.” In fact, in this time of harsh economic conditions, many workers are willing to make sacrifices to keep their jobs because they trust in their firm, but only if they see the same effort from those in higher positions and feel like they are a part of the company.

On a positive note, compared to the manufacturing industry, the construction industry's major strength is having a strong component of work being "handcrafted," which allows each individual to leave a tangible sign of the work carried out. In the construction industry, there are few actual repetitive tasks, as each site is unique in shapes, materials, requirements of the contract, and people involved. For this reason, working in the construction industry always involves a team effort. No workmanship can be performed only by a single worker, and unlike the manufacturing industry, no one is ever “just monitoring” machinery. Instead, one is always actively participating in production. Each team usually consists of at least 2 or 3 people, and each team members' ability to collaborate and understand the final objective plays an essential role in safety management.

WORKERS' INVOLVEMENT AND COMMUNICATION MODE

Involving the workforce in identifying and controlling risks plays a crucial role in reducing the high accident rate associated with construction work. In fact, the workforce has direct experience in working on site, and is often the first group that can detect potentially dangerous situations. Therefore, if workers know what they are doing well, the safety risks are less than those workers using imposed work methods that they are unaware of or are unprepared for (Singh 2001).

If employees could actively participate in decisions relating to operational matters and to the manner of executing construction activities, through participating in analysis and coordination meetings of the daily time schedule, they would have firsthand knowledge of the potential hazards and risk at work, thereby preventing the element of surprise, which is almost always caused by lack of knowledge of the risks. This way the situations of risk may be managed more effectively.

Ideally, the person coordinating these meetings collects workers' feedback and turns it into concrete and immediate actions, encouraging involvement and confidence that leads to empowering workers. The data collection would involve asking the workers for feedback on:

- executive procedures;
- the planned schedule;
- equipment and machinery;
- feedback about the execution (e.g. issues such as nonconformities with standards, uncomfortable situations, etc.).

Managers would then be able to know in advance the likely actions that the worker could execute in accordance with the provisions for the work's execution, or alternatively know how many "inventive steps" would be necessary to perform the work as well as they believe should be done. If not properly handled, this second situation can create unknown, unpredictable, and therefore dangerous situations.

Schematically, a procedure of involvement may be formulated as follows:

- **Risk assessment:** Both workers and their representatives throughout the construction process should be offered to express their opinions about problems and solutions (EU-OSHA 2012). As a critical management process, the risk assessment aims to protect workers.
- **Constitution of working groups:** Workers and their representatives should be invited to participate in planning safety measures for a specific hazard, so employees' work experience will be considered. This involvement will increase the chance that workers will comply with these measures. Even after the control measures are revised, the employees should be invited to give feedback about the implementation.
- **Training, information and participation:** These can be promoted by giving workers the opportunity to discuss and express their views on the issues addressed. Workers must be properly and promptly informed about issues related to their H&S.
- **An organized and deliberate feedback system:** It must offer reporting procedures that allow workers to report accidents, near-misses etc., while still allowing them to provide feedback and ideas to improve health and safety at work. Workers need to receive feedback on each proposed idea, even when such feedback expresses the impossibility of implementation. Not receiving any reply to a suggestion can deeply frustrate employees.

To implement these procedures, direct channels for informing and consulting workers may be used, which include surveys, suggestions, internal newsletters, the intranet etc. The discussion must be extensive and not limited to physical hazards and safety standards. Issues such as work organization, changes to the production, technologies

and working methods or devices may all determine H&S.

INCENTIVIZING FIRMS TO INCORPORATE SAFETY INTO WORK

Contractors and subcontractors should be encouraged to invest in the well-being and safety of workers and to provide a fulfilling and engaging work environment. Responsibility for the quality management involves all the above choices, and if the subcontractors manage the safety and quality of work on a construction site with this approach, it should be possible to create a virtuous cycle in which attention is given to companies that invest in the well-being and safety of workers.

What should also be given equal attention is sharing tasks in the management phase of intervention and construction, in order to avoid overwhelming someone with the responsibility of managing the execution time and the actual construction costs. While providing workers with a constructive atmosphere, the project manager must also encourage effective economic and time management. The project manager must carry out the assessment timing and cost of the project in the most realistic way possible, without forcing the workers on the construction site to work shifts with an unsustainable pace physically and cognitively.

In fact, the pressure of productivity, which results in both time and cost savings, plays a significant role on construction job sites (Singh 1999). Site managers and superintendents should serve as good examples by performing at estimated speeds, which may motivate the workers to perform accordingly.

A general contractor should recognize the subcontractors that protect the welfare of workers in the workplace. To do this, the subcontractor needs to identify, through special assessments that are also included in the quality management of businesses, all subcontractors who are eligible under certain criteria (e.g., ensuring not only regular breaks for lunch, but also the intermediate breaks in the morning and afternoon to involve employees in conducting operations).

Nowadays the most important clients in the public and private sectors recognize the importance of good OSH (Occupational Safety and Health) for infrastructure construction and other important works. They are taking a more active role the development of these standards to implement into these projects.

Among the benefits of a good OSH policy in the construction industry include quicker project execution, greater cost-effectiveness, higher profit margins, and a higher probability of customers contracting the provider. These benefits, however, can be achieved only if clients, as in public authorities contracting the projects, prove themselves as ready to participate actively in the project and help raise the standards of OSH. In fact the customers are the ones who set objectives and controlling resources and, therefore, establish performance standards on OSH project (Mossink and De Greef 2002). Public authorities thus have a great responsibility in this area, because they can greatly influence the market due to their enormous purchasing power. Therefore, they should set the example of best practice for the integration of OSH standards in the procurement of public works.

CONCLUSION

This paper highlights how important and profitable it is to consider the welfare of workers through developing a culture of safe working conditions beyond simple accident prevention on construction sites. Topics addressed show how recognition and empowerment enable all workers to contribute to achieving objectives. Collaboration between workers and managers and the introduction of an occupational safety culture beyond the traditional approach do not increase net costs, but rather prove themselves as an optimal investment that sustainably increases productivity. Empowering all workers in creating a safe working environment also communicates respect to them, prevents accidents and deaths, and improves the workers' overall well-being.

REFERENCES

- Di Giuda, G M, Gottfried A, Lanticina, M, and Villa, V (2010) "Progettazione e gestione della sicurezza nei cantieri edili." Torino, UTET Scienze Tecniche.
- Di Giuda, G M, Gottfried, A, Piantanida, P and Villa, V (2012) Analysis of accidents in the Italian construction industry, pp. 1053-1057, ISEC-SEA "Research, Development, and Practice in Structural Engineering and Construction". Vanissorn Vimonsatit, Amarjit Singh, and Siamak Yazdani (Eds.), Research Publishing.
- European Agency for Safety and Health at Work (EU-OSHA) (2011) "Innovative solutions to safety and health risks in the construction, healthcare and HORECA sectors. Publications Office of the European Union." Retrieved from <https://osha.europa.eu/en/publications/reports/innovative-solutions-OSHRisks>
- European Agency for Safety and Health at Work (EU-OSHA) (2012) "Worker Representation and Consultation on Health and Safety. An analysis of the findings of the European Survey of Enterprises on New and Emerging Risks". Publications Office of the European Union. Retrieved from https://osha.europa.eu/en/publications/reports/esener_workers-involvement
- European Agency for Safety and Health at Work (EU-OSHA) (2013) "E-fact 76: Wellbeing at Work: Creating a Positive Work Environment". Retrieved from <https://osha.europa.eu/en/publications/e-facts/e-fact-76-wellbeing-at-work>
- Galloway, S M (2012) "Zero Incident Goals Motivate Risk-Taking, Not Excellence". Occupational Health & Safety.
- Health and Safety Executive (2007) "Managing Health and Safety in Construction". HSE Books. Retrieved from <http://www.hse.gov.uk/pubns/priced/1144.pdf>
- INAIL, National Institute for Insurance against Accidents at Work (2009) "Report on Accident Trends". Retrieved from http://www.inail.it/internet_web/wcm/idc/groups/salastampa/documents/document/ucm_portstg_099650.pdf
- International Labour Organization (2012) "Estimating the Economic Costs of Occupational Injuries and Illnesses in Developing Countries: Essential Information for Decision-Makers". Retrieved from http://www.ilo.org/wcmsp5/groups/public/---ed_protect/---protrav/---safework/documents/publication/wcms_207690.pdf

- Mossink, J and De Greef, M (2002) "Inventory of Socioeconomic Costs of Work Accidents". European Agency for Safety and Health at Work, Luxembourg, Publications Office of the European Union.
- Singh, A (1999) "Innovative Fall Protection for Construction Workers on Low-rise Roof". Rinker Eminent Scholar Lecture Series on Construction Safety and Health, Building Construction Report 001, Publication 017, Univ. of Florida, Gainesville.
- Singh, A (2001) "Beyond Zero Accidents: Improving Worker Well-being". CIB World Building Congress.
- Schulte, P and Vainio, H (2010) Well-being at work: Overview and perspective. "Scandinavian Journal of Work, Environment and Health", Vol. 36, No 5, pp. 422–429.
- Taylor, F W (1997) "The Principles of Scientific Management". Dover Publications.

WORKPLACE STRESS AND ITS IMPACT ANALYSIS FOR STRATEGIC STRESS MANAGEMENT IN CONSTRUCTION PROJECTS

YK Fiona Lamari³² and Seokho Chi²

*¹Civil Engineering and Built Environment School, Science and Engineering Faculty, Queensland
University of Technology, Brisbane, Queensland, Australia*

²Department of Civil and Environmental Engineering, Seoul National University, Seoul, Korea

Workplace stress has been an increasing concern in the construction industry. Workers are working longer hours and construction managers' responsibilities are becoming more complex and complicated due to reduced resources and widespread stakeholder involvements. These additional pressures potentially trigger workplace stress and impact on project performance. The purpose of this study is to examine and advance understanding of stress and its impact relationships that support holistic and strategic stress management. 17 key stress sources are identified with their impact relationships on different stress types examined. Based on the research findings, this paper concludes with a Stressor-Stress-Performance relationships map.

Keywords: construction safety, construction work stress, occupational health and safety in construction, stress mitigation.

INTRODUCTION

The construction market is competitive and challenging. The global financial crisis has tightened the project budget, with the state budget cut impacting the public construction, residential and commercial construction activity suffered extended slowdown (Goh 2005; You and Zi 2007). The shortage of skilled labours has also caused a reduction in construction productivity (Hyari et al. 2010; McGrath-Champ et al. 2011). Although recent technology innovation can potentially compensate such limitations, construction organisations are not eager on new investment due to limited resources. With the limited budget and affected productivity, construction organisations struggled to design, construct and deliver the project as well as meeting the expected time and quality targets. Moreover, a construction project involves different stakeholders but its dynamic, complicated and unpredictable nature has caused a range of managerial issues such as ambiguity on job requirements, inadequate work responsibilities and poor relationship between stakeholders (Ng et al. 2005; CIOB 2009; Ibem et al. 2011). When these factors are combined, they become the sources of workplace stress in the construction industry.

Construction work stress and its effect on workplace and safety performances are gaining more research attention (for examples, CIOB 2009; Leung et al. 2011b, Love et al. 2010). Workplace stress has a negative impact on project performance (Schaufeli

³² fiona.lamari@qut.edu.au

and Bakker 2004; Blackhall and Littlemore 2010; Leung et al. 2010; Leung et al. 2011a). Recent study by Blackhall and Littlemore (2010) showed that workplace stress causes poor communication of critical project information and isolation from resources, thus leads to decision making problems. Leung et al. (2010) identified there is high correlation between emotional and physical stress and safety behaviours. Leung et al. (2011a) investigated the negative impact of physical and physiological stress on work productivity and organisational performance. To prevent a negative impact of workplace stress on project delivery, some researchers proposed stress management solutions so that construction workers are able to control the root cause of problems and minimise their impacts (Love et al. 2010; Townsend et al. 2011). Love et al. (2010) analysed the relationship between the social and work supports and the mental health and determined the supports played a key role to fostering of good mental health for construction workers. Similarly, Townsend et al. (2011) emphasised that good work-life balance was essential for stress management and thus helped a project team reach performance targets.

Despite these achievements, workplace stress still exists in construction projects. That is because stress causation and its impact are not a discrete event; they have an interrelationship explaining different stressors and their impacts on the project performance. For instance, work schedule pressure can cause physical stress of workers and such physical burnout may negatively impact on work performance and construction safety. As a result, poor performance and safety might result in project delay causing an additional source of the stress (Figure 1 Example A). In this case, the stressor and impact relationship is rather a holistic loop and it is important to break any chain of events through strategic intervention. On the other hand, poor organisational policy (a stressor) does not only cause psychological stress of workers but can also directly impact on work performance (Figure 1 Example B). In this case, both root stressor and the psychological stress need to be eliminated or minimised to reduce their impact on the project. However, there has been a lack of existing studies to discuss such holistic relationships, customise these relationships to suit different stressors and use them for strategic stress management.

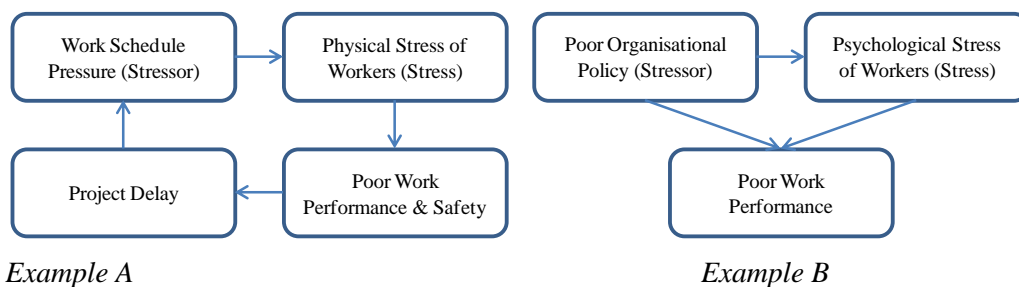

Figure 1: Examples of different relationships of the stressor and its impact

The present study aims to determine stress and its impact relationships that support holistic and strategic stress management. The authors conducted an extensive literature review on stress sources on construction projects, impacts of stress on construction workers and impacts of worker stress on project performance. Based on the literature findings, the authors then developed a stressor-stress-performance conceptual model which is discussed at the end of this paper.

STRESS LITERATURE OVERVIEW

Stress Sources in Construction Projects

Workplace stress has adverse effects on work performance and thus many research studies have investigated the root causes (sources) of stress that may exist on construction projects. In 1989, Sutherland and Davidson (1989) conducted a pilot study to investigate stress sources among site managers in large UK construction organisations. Throughout their interview process with the industry, they found stress is perceived as strain, pressure, worry, irritation and frustration. The most frequently cited sources of stress they have identified included: inadequacy/inconsistency of communication flow (communication problem); too much paperwork; work overload and time pressure; staffing problems – lack of competent staff to do the job properly, inadequate numbers of staff to do the job properly and unable to delegate because of staffing problems; conflict of boundary situation; working long hours, restrictions concerning time spent with family and at home; and pressure associated with the dynamic and competitive organisational culture. Most of identified stress sources were related to factors intrinsic to the job or the stress of “being in the organisation”. Career stress was rarely reported due to the buoyant construction market in the 1980s.

Goldenhar et al. (2003) argued that it is important to reduce worker exposure to extraneous work stressors and grouped the stressors into three categories: job-task demands, organisational stressors and physical and chemical hazards and protection from them. The first category, job-task demands, included job control and decision latitude, job demands and work difficulty, overcompensation specifically for female workers, skill utilisation and work responsibility. The second category, organisational stressors, included safety climate, the availability of skills and safety training, job certainty, support from co-workers and supervisors and harassment or discrimination. The last category, physical and chemical hazards and protection, contained the measures of exposure and safety compliance. Working conditions with heavy equipment, noise or vibration and the chemical exposure to asbestos, lead or epoxy resins also fall into this category.

Ng et al. (2005) considered stressors among construction project participants more intensively and examined the relationships between individual stressors to assess the combined effects of different stressors. They grouped 34 stressors with similar characteristics together and condensed into seven stressor categories: (1) works nature related stressors , (2) works time related stressors , (3) organisation policy related stressors , (4) organisation position related stressors , (5) situational and environmental stressors , (6) relationship related stressors , and (7) personal stressors . Works nature related stressors included qualitative work overload, too specialised job nature, job nature renders too much contact with people and low job challenges. On the other hand, works time related stressors include quantitative work overload, tight time frame for works, unstable working hours and work underload (underutilisation of ability). The organisation policy category explains inadequate knowledge of project objectives, conflicts among different job demands, adaptability problem with change of job natures, inadequate room for innovation and bureaucracy. Inadequate authority and freedom for decision, unsatisfied salary, lack of career guidance, lack of promotion opportunity and lack of job stability fall under the organisation position category. Situational and environmental stressors include different views from superiors, role conflicts, unfair assignment of workload, poor working environment,

and exposure to dangerous working conditions. Relationship related stressors discussed low recognition received for work done, problem with superiors' management style, poor communication with counter players, poor communication with superiors and subordinates and poor relationship with colleagues. Lastly, personal stressors consider problem with ability application, lack of opportunity to learn new skills, work-family conflicts and inadequate recess. They also investigated and identified strong relationships among different stressors such as the correlation between "quantitative work overload" and "tight timeframe work works", one between "qualitative work overload" and "job renders too much contact with people" and one between "lack of career guidance" and "problem with superior's management style".

Leung et al. (2010) identified 11 stressors in the Hong Kong construction industry. Work-related stressors included: work overload, role ambiguity in terms of work expectation, scope and responsibilities, and lack of autonomy considering freedom, independence and secretion in scheduling and performing the work (task stressors); unfair reward and treatment and inappropriate safety equipment (organisational stressors); type A personality– aggressive, competitive, hasty, time impatient, insecure or hostile behaviour, optimism (personal stressors); inter-role conflict, poor workgroup relationship, lack of feedback from supervisors and management personnel (interpersonal stressors); poor physical environment with extreme temperature, poor air quality and excessive noise and unsafe environment (physical stressors). Similarly, Leung et al. (2011a) determined five common types of organisational stressors that considered unfair rewards and treatment, inappropriate safety equipment, provision of training, lack of goal setting and poor physical working environment.

Love et al. (2010) examined work-related stressors in the Australian construction industry. In their 2010 study, they distinguished workplace stress items between contractors and consultants. These work-related stressors included work-family conflicts, skill utilisation and work responsibilities, poor workgroup relationship, poor physical working environment, lack of feedback from supervisors and management personnel, inadequate knowledge of project objectives, lack of job stability, tight time frame for works, low recognition received for work done and lack of work motivation. Their findings indicated that contractors tended to identify stress in their workplaces associated with lack of control, clarity and certainty as well as a lack of feedback and appreciation combined with the sense of being criticised at work.

Ibem et al. (2011) investigated key stress factors among construction professionals in the building construction industry in Nigeria. They categorised the stressors into four groups: work demand related stressors, physical work environment stressors, job role stressors, and organisational related stressors. Work demand related stressors include working in isolation, ambitious deadlines, budget-related pressures, number of working hours and volume of work. Physical work environment stressor comprise inadequate ventilation of site offices, spatial inadequacy of site offices, lack of privacy in site offices, poor lighting of site offices, inadequate temperature control in site offices, noise level on site, poor site condition and safety and security measures on construction sites. Job role stressors refer to lack of clarity of role, variations in the scope of work, fragmentation of work, job insecurity and inadequate skills. The forth group, organisational related stressors include inadequate staffing, poor communication, poor planning, insufficient on-the-job training, lack of adequate feedback, inter-personal conflict, poor inter-personal relationship, poor crisis

management mechanism, inadequate equipment, bullying by senior colleagues and poor remuneration.

Based on the literature, the authors conclude by grouping the stress sources into four main categories (1) work demands, (2) organisational culture, (3) physical work environment, and (4) personal/inter-personal relationship. Common key stressors in construction projects were identified by counting their frequency. For example, if a stressor was discussed in one article only, one-star is given and it represents low frequency. Two-star or three-star are assigned to the stressor when it is emphasised by two to four articles or more than four articles respectively. Eight stressors (work planning and communication problem; staffing problems; training and education; job stability; unsatisfied salary; low recognition and rewards; support from co-workers and supervisors; and role conflicts) were identified as normal stressors with the medium frequency and nine stressors (work overload and time pressure; work scope and responsibilities; work-life balance problem; job control and decision latitude; work difficulty and lack of skills; workplace safety and exposure to risks; poor working environment; poor working relationship with co-workers; and poor working relationship with supervisors) were determined as key stressors with the high frequency.

Impact of Stress on Construction Workers: Different Stress Types

Stressors create different types of stress and can affect the mental and physical health of construction workers (Goldenhar et al. 1998). Goldenhar et al. (2003) measured construction professionals' psychological health conditions based on the feeling level of tension, anger and sadness and determined their physical conditions by asking their experience of insomnia or trouble sleeping, nausea or stomach disorders, headaches and low-back pain. They then assessed the correlation between stressor and health condition to identify significant paths from the stressor to the symptoms. The statistical analysis results determined six direct paths between the stressor and the psychological symptoms: (1) skill under-utilisation, (2) responsibility for safety, (3) job certainty, (4) organisational support, (5) harassment and discrimination and (6) total months working in construction. They also identified five significant predictors for the physical symptoms including (1) job demands, (2) job certainty, (3) harassment and discrimination, (4) safety compliance and (5) total months working in construction.

Leung et al. (2008; 2010; 2011b) identified different types of stress when the work demands or other stressors exceeded the individual's capacity to cope. They delineated three types of stress including job stress (or objective stress), burnout (or emotional/psychological stress) and physiological stress (or physical stress). Job stress is caused when an individual's perceived ability is insufficient to complete or deal with work tasks (Monat and Lazarus 1991; Leung et al. 2007). In construction projects, work overload and time pressure, work difficulty and lack of skills, and work scope and responsibilities can induce the job stress. Burnout represents emotionally drained or chronically fatigued conditions and frustration caused by the failure of work, failure of life or relationship problems (Freudenberger 1983; Cordes and Dougherty 1993). Burnout symptoms may include social life changes, communication problems among project team members, low work motivation and low commitment. The last stress type, physiological stress, implies a body exposure to certain stressful situations and it gradually appears in the form of headaches, stomach disorder, back

pain, appetite loss and others (Mellner et al. 2005). Their stress causation model suggested that burnout is a consequence of job stress and is also an antecedent for physiological stress. Additionally, they investigated correlation between the stressors and the different stress type. They indicated that job stress is highly correlated to work overload, inter-role conflict and poor workgroup relationship; emotional stress is highly determined by work overload, unfair reward and treatment, inappropriate safety equipment, inter-role conflict and poor physical environment; and physical stress is highly related to safety equipment and emotional stress.

Impact of Stress on Project Performance

Workplace stress negatively impacts on the project performance (Schaufeli and Bakker 2004; Blackhall and Littlemore 2010). Leung et al. (2008; 2011b) investigated how different stress types affect the performance of construction project managers. They first defined three performance categories that are critical to their project success including task performance, interpersonal performance and organisational performance. Task performance is determined by time, cost, quality, and safety management performance of the project. Interpersonal performance includes communication and interaction issues among different stakeholders such as the client, the design team, consultants, contractors and subcontractors. Organisational performance means effectiveness or ineffectiveness of the organisation in terms of communication, staffing, training performance and others. The researchers further investigated the correlations between job stress, emotional stress and physical stress and these performance factors. The results showed that job stress is negatively impacted task performance and task performance is positively affected on interpersonal performance. For instance, worker with low level of work skill can lead to low task performance and the poor task performance may result in interpersonal responsibility issues between project team members. Leung et al. also found that both emotional stress and physical stress acted negatively on the organisational performance since organisational performance was closely linked to an employee's morale and sense of belonging. Hence, burnout or physical stress of the project manager may cause a range of withdrawal work behaviours.

The impact of the stress on workplace safety is also investigated by various researchers. Goldenhar et al. (2003) examined the relationship between job stressors and injury and near-miss outcomes and their analysis. They identified eight stressors that led directly to the near miss outcomes. These stressors included psychological symptoms, job control, job demands, skill under-utilisation, safety climate, training, job certainty and safety compliance. Out of the eight stressors, they found five stressors have significant effects on the injury statistics. The injury statistics included physical symptoms, responsibility for safety, hours of exposure to safety hazards, total months working in construction and months worked per year. Similarly, Leung et al. (2010) found that worker injuries on construction sites were positively predicted by the emotional stress since the worker having emotional problems may focus less on safety compliance and procedures. Leung et al. (2011a) supported this finding by claiming that too much or too little emotional stress could lead to poor safety behaviours but moderate stress levels resulted in better safety behaviours. They also concluded a positive linear relationship between physical stress and safety behaviour, implying construction workers with physical stress are more likely to display safety behaviours on the job, even physical stress negatively affects on worker's health condition.

STRESS AND IMPACT ANALYSIS MODEL DEVELOPMENT

Conceptual Research Framework

The study presented in this paper aims to determine stress and its impact relationships that would ultimately support holistic and strategic stress management. The authors reviewed studies on workplace stress in construction projects published up to 2012. The authors conducted searches in peer reviewed journals through the university library database. Results were summarised based on stress factors, stressors and their impact of the stressors on performance, safety management and stress management. After screening obtained peer-reviewed articles for relevance, the authors consider seven articles published between 2003 and 2011. A total of 17 stressors were identified: eight normal stressors with the medium frequency and nine key stressors were with high frequency.

Once key stressors were identified, the correlations between the stressors and their impacts on worker's health and project performance were analysed through case studies captured from the journal articles below. The following section outlines the development of the Stressor-Stress-Performance relationships model.

- Modelling relationships between job stressors and injury and near-miss outcomes for construction labourers (Goldenhar et al. 2003)
- Job demands, job resources, and their relationship with burnout and engagement: a multi-sample study (Schaufeli and Bakker 2004)
- Manageability of stress among construction project participants (Ng et al. 2005)
- Impact of stress on the performance of construction project managers (Leung et al. 2008)
- Impacts of stressors and stress on the injury incidents of construction workers in Hong Kong (Leung et al. 2010)
- Preventing construction worker injury incidents through the management of personal stress and organisational stressors (Leung et al. 2011a)
- Structural linear relationships between job stress, burnout, physiological stress, and performance of construction project managers (Leung et al. 2011b)

Stressor-Stress-Performance Relationships

The authors first identified positive and negative causal relationships between different stressors through case studies. More specifically, the following 15 positive correlations were examined: (1) "work scope and responsibilities" and "job stability"; (2) "work scope and responsibilities" and "job control and decision latitude"; (3) "job control and decision latitude" and "job stability"; (4) "supports from co-workers and supervisors" and "training and education"; (5) "supports from co-workers and supervisors" and "job control and decision latitude"; (6) "work difficulties and lack of skills" and "poor workplace safety and exposure to risks"; (7) "work difficulties and lack of skills" and "role conflicts"; (8) "work difficulties and lack of skills" and "work overload and time pressure"; (9) "work overload and time pressure" and "work-life balance problem"; (10) "role conflicts" and "low recognition and rewards"; (11) "role conflicts" and "poor workplace safety and exposure to risks"; (12) "poor workplace safety and exposure to risks" and "poor working relationship with co-workers"; (13) "poor working relationship with co-workers" and "low recognition and rewards"; (14)

“poor working relationship with co-workers” and “poor working relationship with supervisors”; and (15) “poor working relationship with supervisors” and “low recognition and rewards”. For example, construction workers experiencing work overload may cause work-life balance problem; on the other hand, clear work scope and work responsibilities can promote better job control and decision making; and low recognition and rewards may deteriorate the working relationship with supervisors.

Similarly, 11 negative correlations were found: (1) “work scope and responsibilities” and “poor working relationship with co-workers”; (2) “work scope and responsibilities” and “poor workplace safety and exposure to risks”; (3) “work scope and responsibilities” and “work difficulties and lack of skills”; (4) “work scope and responsibilities” and “work overload and time pressure”; (5) “job stability” and “unsatisfied salary”; (6) “poor workplace safety and exposure to risks” and “job control and decision latitude”; (7) “poor workplace safety and exposure to risks” and “support from co-workers and supervisors”; (8) “poor workplace safety and exposure to risks” and “training and education”; (9) “training and education” and “work difficulties and lack of skills”; (10) “poor workplace safety and exposure to risks” and “work difficulties and lack of skills”; and (11) “work difficulties and lack of skills” and “job control and decision latitude”. For instance, lack of training and education can result in poor workplace safety and create more chance for workers to expose to safety hazards and risks. If there is lack of supports from co-workers and supervisors, workers might have more difficulties in completing the work. Poor workplace safety and frequent exposure to safety risks will also potentially lead to more difficult job control and decision making.

Seventeen stress sources were identified based on an extensive review of stress literature in construction. The seven research studies highlighted in the previous section examined the relationships of 14 stress sources. Based on the in-depth discussion of literature in earlier sections, the authors proposed additional links between the remaining three stressors: (1) “staffing problem”; (2) “work planning and communication problem”; and (3) “poor working environment” and the other 14 stressors. The following positive and negative relationships are suggested:

- A negative relationship between “staffing problem” and “work scope and responsibilities” and a positive relationship between “staffing problem” and “work difficulties and lack of skills”: a poor work scope can result in staffing problem and the staffing problem can also make issues on the assignment of work responsibility. If there is staffing problems, the work should be more difficult to be completed.
- Negative relationships between “work planning and communication problems” and “work scope and responsibilities” and between “work planning and communication problems” and “job control and decision latitude” and a positive relationship between “work planning and communication problems” and “work difficulties and lack of skills”: a poor work planning may cause work scoping problems and make job control more challenging. A communication problem will also affect job control and decision making processes. The more work planning and communication problems occur, the more difficult a good work performance is achieved.
- Positive relationships between “poor working environment” and “poor workplace safety and exposure to risks” and between “poor working environment” and “work difficulties and lack of skills” and a negative

relationship between “poor working environment” and “job control and decision latitude”: a poor working environment can be caused by extreme temperature, poor air quality or noise problem and thus may lead to poor workplace safety and more challenges to control and complete the work tasks. Once the relationships between different stressors were identified, the authors analysed the relationships between stressors, stress types and project performance. Research findings suggested that, in general, the identified stressors create stress in construction workers and the resulted stress impacts on project performance. In this study, three different stress types are considered: job stress, emotional (psychological) stress and physical stress. Job stress is caused when a worker’s ability is insufficient to complete or perform the work assigned. Emotional stress represents mentally drained or chronically fatigued conditions and any frustration. Physical stress appears a form of headaches, stomach disorder, back pain, appetite loss, etc. when a worker is exposed to stressful working conditions.

The following stressors related to job stress are considered in this study: “work overload and time pressure”, “role conflicts”, “poor working relationship with supervisors”, and “poor working relationship with co-workers”. For instance, when the construction workers experience time pressure, they tend to get stress about their work ability to meet the requirements. The following stressors are determined as sources for the emotional stress: “work difficulties and lack of skills”, “work-life balance problem”, “work overload and time pressure”, “low recognition and rewards”, “role conflicts”, “training and education”, “support from co-workers and supervisors”, “poor workplace safety and exposure to risks”, “poor working environment”, “job stability”, and “work scope and responsibilities”. Lastly, physical stress is found to be associated with the following stressors: “work-life balance problem”, “work overload and time pressure”, “job stability”, and “poor workplace safety and exposure to risks”. For example, overtime work may cause physical fatigue for workers leading to additional physical health problems. The present study also examined the inter-relationship between different stress types. In general, job stress appears to cause emotional stress, specifically in the event of difficulties in or failure of work or working relationship problems with co-workers or supervisors. Emotional stress such as burnout, fatigue or mental disorder is then developed to the physical stress causing physiological health problems for workers.

By investigating the correlation between different stress types and project performance, the authors found emotional and physical stress can predict safety behaviours of workers. Construction workers with high level of emotional stress may over-simulate demanding work tasks and thus concentrate more on completing the work and less on safety practice. However, too little emotional stress can also cause poor safety behaviours since workers might overestimate their work skills and become less careful on their work. The physical stress such as back pain can slow workers’ work pace and thus they may consider their work activities more thoroughly and perform the work more carefully, even though such behaviour may cause negative productivity issues. Additionally, this study suggests that some individual stressors may also directly impact on the safety performance and they are: “work overload and time pressure”, “training and education”, “work difficulties and lack of skills”, “job control and decision latitude”, “job stability”, “work scope and responsibilities”, and “poor workplace safety and exposure to risks”. It is clear that these stressors can

directly affect safety performance; for instance, lack of training and educational supports will result in poor safety performance.

Other than safety performance, there were three additional performance categories: task performance, interpersonal performance and organisational performance. Job stress can directly affect task performance and the resulted task performance may either result in good interpersonal performance between project stakeholders or deteriorate the interpersonal performance. Although good task performance can potentially motivate and encourage workers for better interpersonal relationships, low task performance may lead to a situation passing the responsibilities to each other between the project team members. Both emotional and physical stress can be related to the organisational performance; the workers suffering from the emotional or physical stress may be less enthusiastic or responsible on their work belonging and cause a range of withdrawal work behaviours.

Based on the findings presented above, a Stressor-Stress-Performance relationship (SSPr) map is developed as shown in Figure 2. The SSPr map attempts to explain the chain of events of stress causation and its impact analysis. For instance, work scope and responsibility problem can cause work overload and time pressure leading to work-life balance problem. Work scope and responsibility problem may cause emotional stress as well as poor safety performance. Work overload and time pressure will highly relate to all three stress types resulting in poor task, interpersonal, organisational and safety performance. Work-life balance problem may also be linked to the emotional and physical stress. For instance, the poor working relationship with supervisor may be positively linked with the low recognition and rewards as well as with poor working relationship with co-workers, causing job stress that negatively affects task and interpersonal performance.

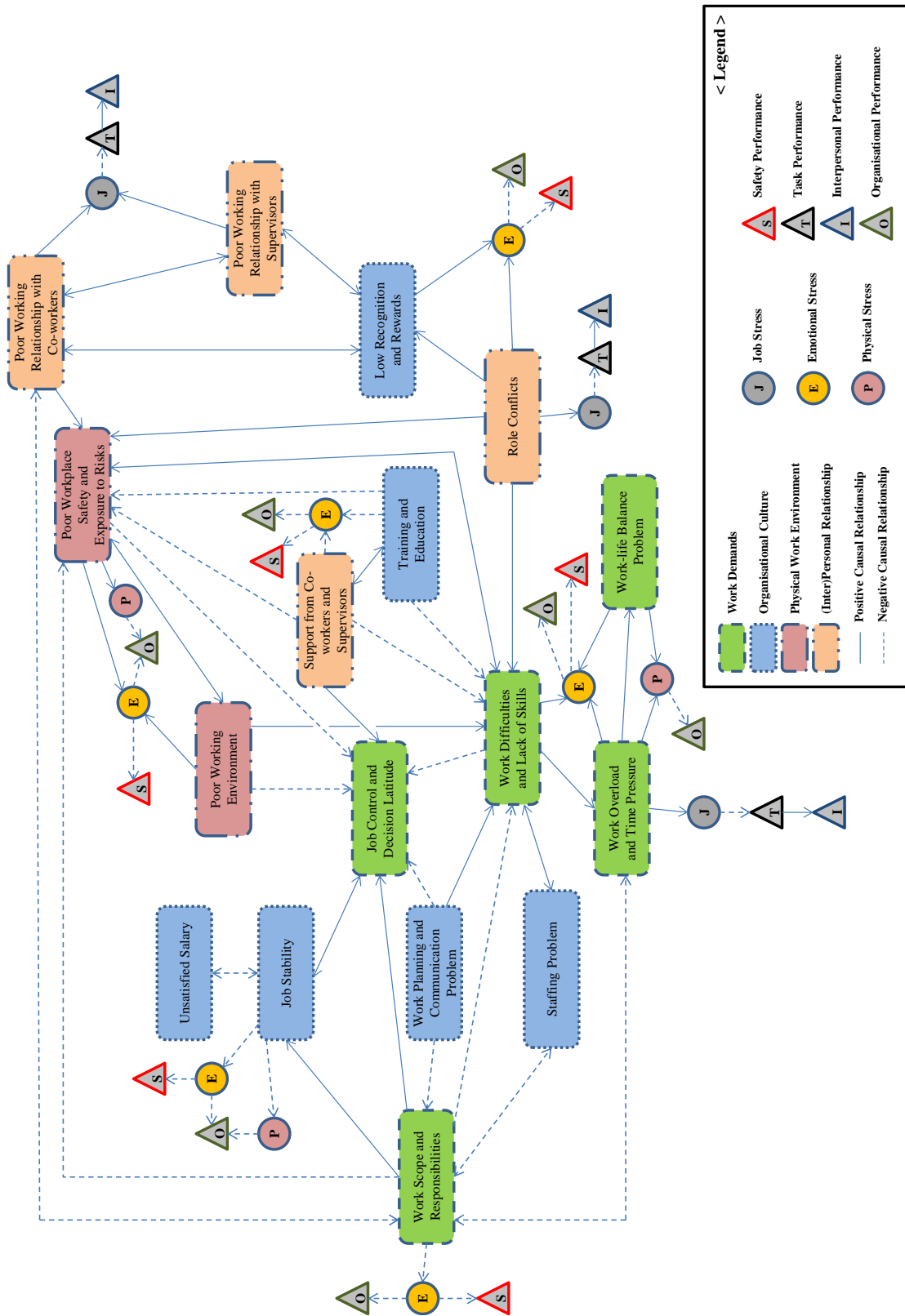

Figure 2: Concept map illustrating stressor-stress-performance relationships

CONCLUSIONS AND DIRECTIONS FOR FUTURE RESEARCH

This paper examined and advanced our understanding of construction work stress and its impact relationships. 'The construction industry is considered to be one of the most dangerous industries in which to work' (CIOB 2009). Significant relationships were found between workplace stress and its impact on performance in terms of safety, productivity and quality. A call for workplace stress management is apparent. The authors identified 17 stress sources and their impacts on different stress types including job, psychological and physiological stress based on an extensive literature review and empirical analysis. The next stage of research is evaluation and validation of the SSPr map.

Based on the proposed SSPr map, it is possible to develop a stress and impact analysis model which can be used for strategic stress management. If the relationships between stressor-stress-performance are prominent, early understanding and detection of worker stress can potentially identify issues while still minor and controllable, preventing not only hindered performance, but also reducing morbidity and cost to the organisation.

REFERENCES

- Blackhall, I., Littlemore, M., 2010. The impacts of personal stress upon critical project decision making in construction. *Built and Natural Environment Research Papers* 3(1), 7-16.
- CIOB, 2009. *Health and safety in the construction industry 2009*. Berkshire, U.K., The Chartered Institute of Building.
- Cordes, C.L., Dougherty, T.W., 1993. A review and an integration of research on job burnout. *Academy of Management Review* 18(4), 621-656.
- Freudenberger, H.J., 1983. *Stress and burnout*. Doubleday, New York: Anchor Press.
- Goh, B.H., 2005. The dynamic effects of the Asian financial crisis on construction demand and tender price levels in Singapore. *Building and Environment* 40(2), 267-276.
- Goldenhar, L.M., Williams, L.J., Swanson, N.G., 2003. Modelling relationships between job stressors and injury and near-miss outcomes for construction labourers. *Work and Stress* 17(3), 218-240.
- Goldenhar, L.M., Swanson, N.G., Hurrell, J.J., Ruder, A., Deddens, J., 1998. Job stressors and adverse outcomes for female construction workers. *Journal of Occupational Health Psychology* 3(1), 19-32.
- Hyari, K., El-Mashaleh, M., Kandil, A., 2010. Optimal assignment of multiskilled labor in building construction projects. *International Journal of Construction Education and Research* 6(1), 70-80.
- Ibem, E.O., Anosike, M.N., Azuh, D.E., Mosaku, T.O., 2011. Work stress among professionals in the building construction industry in Nigeria. *Australasian Journal of Construction Economics and Building* 11(3), 45-57.
- Leung, M., Chan, I.Y.S., Yu, J., 2011a. Preventing construction worker injury incidents through the management of personal stress and organizational stressors. *Accident Analysis and Prevention* 48, 156-166.

- Leung, M., Chan, Y.S.I., Dongyu, C., 2011b. Structural linear relationships between job stress, burnout, physiological stress, and performance of construction project managers. *Engineering, Construction and Architectural Management* 18(3), 312-328.
- Leung, M., Chan, Y., Yuen, K., 2010. Impacts of stressors and stress on the injury incidents of construction workers in Hong Kong. *Journal of Construction Engineering and Management* 136(10), 1093-1103.
- Leung, M., Chan, Y., Olomolaiye, P., 2008. Impact of stress on the performance of construction project managers. *Journal of Construction Engineering and Management* 134(8), 644-652.
- Leung, M., Sham, J., Chan, Y., 2007. Adjusting stressors-job-demand stress in preventing rustout/burnout in estimators. *Surveying and Built Environment* 18(1), 17-26.
- Love, P.E.D., Edwards, D.J., Irani, Z., 2010. Work stress, support, and mental health in construction. *Journal of Construction Engineering and Management* 136(6), 650-658.
- McGrath-Champ, S., Rosewarne, S., Rittau, Y., 2011. From one skill shortage to the next: the Australian construction industry and geographies of a global labour market. *Journal of Industrial Relations* 53(4), 467-485.
- Mellner, C., Krantz, G., Lundberg, U., 2005. Medically unexplained symptoms in women as related to physiological stress responses. *Stress and Health: Journal of International Society for the Investigation of Stress* 21(1): 45-52.
- Monat, A., Lazarus, R.S., 1991. *Stress and coping: an anthology*. New York: Columbia University Press.
- Ng, S.T., Skitmore, R.M., Leung, T.K.C., 2005. Manageability of stress among construction project participants. *Engineering, Construction and Architectural Management* 12(3), 264-282.
- Schaufeli, W.B., Bakker, A.B., 2004. Job demands, job resources, and their relationship with burnout and engagement: a multi-sample study. *Journal of Organizational Behaviour* 25, 293-315.
- Sutherland, V., Davidson, M.J., 1989. Stress among construction site managers – a preliminary study. *Stress Medicine* 5, 221-235.
- Townsend, K., Lingard, H., Bradley, L., Brown, K., 2011. Working time alterations within the Australian construction industry. *Personnel Review* 40(1): 70-86.
- You, T., Zi, H., 2007. The economic crisis and efficiency change: evidence from the Korean construction industry. *Applied Economics* 39(14), 1833-1842.

THE MOTIVATORS FOR ADDRESSING CONSTRUCTION HEALTH AND SAFETY (H&S): A HIERARCHICAL PERSPECTIVE

³³J.J. Smallwood

*¹Department of Construction Management, Nelson Mandela Metropolitan University, PO Box 77000,
Port Elizabeth, South Africa, 6031*

International literature indicates that contractors address H&S to varying degrees and achieve varying levels of health and safety (H&S) performance. Furthermore, in South Africa, approximately 50% of contractors do not comply with H&S legislation and regulations, and consequently Department of Labour inspectors issue various notices. Accidents result in work stoppages, injuries, indirect costs which are not insured, and bad publicity resulting in a poor image. However, optimum H&S results in enhanced overall performance and economic benefits such as reduced cost of construction and increased profitability. Consequently, such contractors are more competitive. Furthermore, 'better practice' H&S contractors are more attractive to clients, particularly 'better practice' clients.

The paper reports on a study conducted among contractors that had achieved a first, second, or third place in a regional H&S competition in South Africa to determine whether H&S performance is an evolutionary process.

Selected findings include: H&S is ranked fifth after cost, schedule, quality, and productivity in terms of the importance of project parameters to contractors' organisations; contractors identified a range of motivators for addressing H&S; contractors have evolved in terms of the motivation for addressing H&S, which results in progression to the next stage in the evolutionary process.

Conclusions include the following. Optimum H&S is an evolutionary process, and unless a contractor understands and appreciates the rationale for addressing H&S they will not allocate the requisite resources, and thus fail to evolve in terms of performance. Furthermore, H&S performance will not evolve unless the appropriate motivators are cited or communicated.

Keywords: Health and Safety, Hierarchy, Motivation, Performance

INTRODUCTION

According to the Construction Industry Development (cidb) (2009), during visits to 1 415 construction sites, Department of Labour (DoL) inspectors issued 1 388 notices, namely 86 (6%) improvement notices, 1 015 (73%) contravention notices, and 287 (21%) prohibition notices. Furthermore, 52.5% of contractors were non-compliant.

The level of non-compliance engenders the questions: 'Why do contractors not comply?' and 'Why do some contractors optimise performance?' To this end an exploratory study 'Motivators for Addressing Construction Health and Safety (H&S)'

³³ John.Smallwood@nmmu.ac.za

was conducted to determine the reasons why contractors address construction H&S, their progression relative thereto, and whether it is an evolutionary process or not.

REVIEW OF THE LITERATURE

Importance of the project parameters

Historically, research findings indicate that the traditional project parameters of cost, quality, and time, take precedence over H&S in terms of the importance of project parameters. An 'image of contractors' study conducted by Smallwood (2010) required respondents to indicate the importance of twenty-six image related aspects. The mean scores recorded between parentheses are between 1.00 and 5.00. Based upon the client related responses, quality (4.75) and remaining within budget (4.75) were ranked joint first, time performance (4.25) eighth, health (4.00) eleventh, and safety (3.75) thirteenth.

Cost of Accidents (CoA)

The direct and indirect cost of accidents (CoA) collectively constitute the total CoA. The CoA is a financial measure that can readily be related to by all stakeholders as it can be expressed as a percentage of organisation business volume or value of construction completed nationally. Direct costs tend to be those associated with the treatment of injuries and any unique compensation offered to workers as a consequence of being injured. Indirect costs include reduced productivity for both the returned worker(s) and the team, clean-up costs, replacement costs, stand-by costs, cost of overtime, administrative costs, replacement worker orientation, costs resulting from delays, supervision costs, costs related to rescheduling, transportation, and wages paid while the injured is idle. Although the direct costs are covered by workers' compensation insurance, the indirect costs are borne by contractors (Hinze, 2006).

Economics of Health and Safety

Given that the COA is estimated to be between 4.3% and 5.4% of the value of completed construction, whereas the cost of implementing H&S is estimated to be between 0.5% and 3% of project costs, clearly H&S is a 'profit centre' (Smallwood, 2004). Research conducted by Ikpe, Hammond, Proverbs, and Oloke (2011) determined that the benefits of accident prevention outweigh the costs of accident prevention by a ratio of approximately 3:1 - 62% benefit gain to 38% benefit loss. These findings clearly constitute a financial motivation for addressing H&S.

Research conducted among construction project managers in South Africa (Smallwood, 1996 in cidb, 2009) determined, inter alia, that productivity (87.2%) and quality (80.8%) predominated in terms of aspects negatively affected by inadequate H&S, followed by cost (72.3%), client perception (68.1%), environment (66%), and schedule (57.4%). This finding quantifies the synergy between H&S and the other project parameters, and constitutes a further motivator for addressing H&S.

Values

Zwetsloot, van Scheppingen, Bos, Dijkman, and Starren (2013) identify 29 values and value-related factors as supportive to H&S, which in turn were clustered around seven core values. These seven core values were then grouped in three value clusters. Positive attitude toward people and their 'being' characterises the first value cluster and is comprised of the core values of interconnectedness, participation, and trust. The

second value cluster is relevant for the organisational and individual 'doing', for actions planned or undertaken, and comprises justice and responsibility.

The alignment of personal and organizational development characterises the third value cluster and is relevant for 'becoming', and is comprised of the values of growth and resilience.

Marketing, Public Relations, and Image

A study conducted in South Africa by Smallwood (2005) investigated the marketing benefits of optimum H&S. The study concluded that the TQM related H&S phenomena, which contributed to the acquisition of work, or additional work, clearly indicate the indirect role and benefits of optimum H&S in construction marketing. In essence, optimum H&S does provide 'better practice' H&S general contractors with a competitive edge, and increases their attractiveness to clients. The findings of the 'image of contractors' study reported on earlier, indicated the importance of H&S, which were de-linked for the purpose of the study. A study conducted in the United Kingdom by Brabazon et al. (2000) in Wright and Marsden (2002) determined that the majority of construction sector firms surveyed view H&S performance to be important in terms of commercial success due to its impact on tendering and their reputation. Clearly, performance relative to H&S affects clients' perceptions of a contractor's image, which in turn impacts on their reputation.

RESEARCH METHOD

The sample stratum consisted of fourteen East Cape Master Builders Association (ECMBA) 2013 regional H&S competition award winners that achieved a first, second, or third place. A self-administered questionnaire was sent per e-mail and addressed to the 'Managing Director'. Nine responses were received, which equates to a 64.3% response rate. The sample stratum was selected on the basis of commitment to H&S, and achievement of a recognised standard of H&S performance, and consequently were deemed to be knowledgeable with respect to the process of H&S improvement.

RESEARCH FINDINGS

In terms of education / qualifications, 22.2% of the respondents had Grade 12, 33.3% a National Diploma, 33.3% a BSc and 11.1% a BSc (Honours). In terms of occupation, 55.6% were directors, 11.1% were estimators, and 33.3% represented management.

44.4% had worked for their current employer for 11-20 years, 22.2% for > 20 years, 22.2% for 6-10 years, and 11.1% for 0-5 years. 55.6% had worked in construction for 11-20 years, 33.3% > 20 years, and 11.1% for 0-5 years.

Table 1 indicates the importance of six parameters to respondents' organisations in terms of percentage responses to a scale of 1 (not important) to 5 (very important), and a mean score (MS) ranging between 1.00 and 5.00. It is notable that all the MSs are all above the midpoint score of 3.00, which indicates that in general the respondents can be deemed to perceive the parameters as important. However, given that the MSs for the top five parameters are $> 4.20 \leq 5.00$, the respondents can be deemed to perceive them to be between more than important to very important. It is notable that the three traditional project parameters are ranked within the top three. Environment

falls within the range $> 3.40 \leq 4.20$, and therefore the respondents can be deemed to perceive it to be between important to more than important / more than important.

Table 1: Importance of project parameters to respondents' organisations

Parameter	Response (%)						MS	Rank
	Unsure	Not.....	Very					
Cost	0.0	0.0	0.0	0.0	0.0	100.0	5.00	1
Schedule (Time)	0.0	0.0	0.0	0.0	11.1	88.9	4.89	2
Quality	0.0	0.0	0.0	0.0	22.2	77.8	4.78	3
Productivity	0.0	0.0	0.0	0.0	33.3	66.7	4.67	4
H&S	0.0	0.0	0.0	22.2	22.2	55.6	4.33	5
Environment	0.0	0.0	11.1	44.4	11.1	33.3	3.67	6

Table 2 indicates the extent to which 'motivators' contributed to respondents' organisations addressing H&S on a scale of did not and between 1 (minor) to 5 (major), and a MS ranging between 0.00 and 5.00. It is significant that 41 / 44 (93.2%) of the MSs are above the midpoint score of 2.50, which indicates that the 'motivators' can be deemed to have contributed to respondents' organisations addressing H&S.

It is notable that only 6 / 44 (13.6%) of the MSs are $> 4.17 \leq 5.00$, which indicates the motivators' contributed to respondents' organisations addressing H&S between a near major extent to a major extent / major extent. These are the OH&S Act, image, Construction Regulations, professionalism, reputation, and H&S is an organisation value. It is notable that two 'motivators' are legislation related, and that three 'motivators', namely image, reputation, and professionalism are inter-related. Legislation is invariably a contributor and or motivator as it is enforced, albeit it to varying degrees, by Department of Labour inspectors. Then, H&S is an organisational value is ranked sixth – H&S should be a value as priorities change. This is notable as H&S was ranked 5th in terms of the importance of project parameters to respondents' organisations.

The 'motivators' ranked 7th to 35th have MSs $> 3.33 \leq 4.17$, which indicates they can be deemed to have contributed to respondents' organisations addressing H&S between some extent to a near major extent / near major extent. H&S is a moral issue is the first 'motivator' in this range. The moral 'motivator' is important as it is linked to respect for people, informed by religion in terms of 'I am my brother's / sister's keeper', and thus H&S is an ethical issue. Then a range of 'positive impact of optimum H&S on ' are ranked 8th (MS = 4.11), and 10th to 12th: environment; cost; profitability, and schedule (MSs = 4.00). These were followed by productivity (MS = 4.00) ranked 17th and quality (MS = 3.89) ranked 20th. A range of research findings have addressed and quantified the synergistic effect of optimum H&S (cidb, 2009). Organisation policy is ranked 9th and preservation of organisational integrity (MS = 4.00) is ranked 12th. Legislation refers to H&S policies and an H&S policy is an activity of planning for H&S, and the starting point for H&S practices and interventions. Preservation of organisational, and for that matter, personal integrity, are core competencies, which are certainly compromised when fatalities or disabling injuries are experienced. The COID Act and the National Constitution (MSs = 4.00), both legislation, are ranked 14th and 15th.

Table 2: Extent to which 'motivators' contributed to respondents' organisations addressing H&S

'Motivator'	Response (%)							MS	Rank
	Un- sure	Did not	Minor..... Major						
			1	2	3	4	5		
OH&S Act	11.1	0.0	0.0	0.0	11.1	0.0	77.8	4.75	1
Image	0.0	0.0	0.0	0.0	0.0	55.6	44.4	4.44	2
Construction Regulations	0.0	0.0	0.0	0.0	11.1	33.3	55.6	4.44	3
Professionalism	0.0	0.0	0.0	0.0	0.0	66.7	33.3	4.33	4
Reputation	0.0	0.0	0.0	0.0	0.0	77.8	22.2	4.22	5
H&S is an organisation value	0.0	0.0	0.0	11.1	0.0	44.4	44.4	4.22	6
H&S is a moral issue	0.0	0.0	0.0	0.0	11.1	66.7	22.2	4.11	7
+ Impact of optimum H&S on environment	0.0	0.0	0.0	0.0	33.3	22.2	44.4	4.11	8
Organisation H&S policy	0.0	0.0	0.0	11.1	11.1	33.3	44.4	4.11	9
+ Impact of optimum H&S on cost	0.0	0.0	0.0	0.0	33.3	33.3	33.3	4.00	10
+ Impact of optimum H&S on profitability	0.0	0.0	0.0	0.0	33.3	33.3	33.3	4.00	11
+ Impact of optimum H&S on schedule	0.0	0.0	0.0	0.0	33.3	33.3	33.3	4.00	12
Preservation of organisational integrity	0.0	0.0	0.0	11.1	11.1	44.4	33.3	4.00	13
COID Act	0.0	0.0	0.0	11.1	22.2	22.2	44.4	4.00	14
National Constitution	11.1	0.0	0.0	0.0	44.4	0.0	44.4	4.00	15
Construction Management issue	0.0	0.0	11.1	0.0	11.1	33.3	44.4	4.00	16
+ Impact of optimum H&S on productivity	0.0	0.0	0.0	0.0	37.5	25.0	37.5	4.00	17
Marketing edge / advantage	0.0	0.0	11.1	0.0	11.1	33.3	44.4	4.00	18
H&S specification	0.0	0.0	0.0	0.0	33.3	44.4	22.2	3.89	19
+ Impact of optimum H&S on quality	0.0	0.0	0.0	0.0	33.3	44.4	22.2	3.89	20
- Impact of poor H&S on productivity	0.0	0.0	0.0	0.0	44.4	22.2	33.3	3.89	21
DoL enforcement of legislation & regulations	22.2	0.0	0.0	11.1	22.2	11.1	33.3	3.86	22
Resulting client satisfaction	0.0	0.0	0.0	11.1	22.2	44.4	22.2	3.78	23
Corporate social responsibility issue	0.0	0.0	0.0	22.2	0.0	55.6	22.2	3.78	24
- Impact of poor H&S on cost	0.0	0.0	0.0	11.1	33.3	22.2	33.3	3.78	25
- Impact of poor H&S on profitability	0.0	0.0	0.0	11.1	33.3	22.2	33.3	3.78	26
- Impact of poor H&S on schedule	0.0	0.0	0.0	11.1	33.3	22.2	33.3	3.78	27
Other Regulations	12.5	0.0	0.0	12.5	25.0	25.0	25.0	3.71	28
Resulting worker satisfaction	0.0	0.0	0.0	0.0	44.4	44.4	11.1	3.67	29
- Impact of poor H&S on quality	0.0	0.0	0.0	11.1	33.3	33.3	22.2	3.67	30

- Impact of poor H&S on environment	0.0	0.0	0.0	22.2	22.2	22.2	33.3	3.67	31
Resulting designer satisfaction	0.0	0.0	0.0	11.1	33.3	44.4	11.1	3.56	32
'I am my brother's / sister's keeper'	0.0	0.0	0.0	22.2	11.1	55.6	11.1	3.56	33
Detailed inclusion of H&S in contract documents	0.0	0.0	11.1	11.1	11.1	55.6	11.1	3.44	34
Client 'pressure'	0.0	0.0	11.1	11.1	22.2	33.3	22.2	3.44	35
Client requirements	0.0	0.0	11.1	0.0	44.4	33.3	11.1	3.33	36
Cost of accidents	0.0	0.0	11.1	11.1	44.4	0.0	33.3	3.33	37
Economic benefits of H&S	0.0	11.1	0.0	11.1	11.1	55.6	11.1	3.33	38
Employer association guidance	22.2	0.0	0.0	11.1	44.4	22.2	0.0	3.14	39
Cost of compensation insurance	0.0	0.0	11.1	0.0	66.7	11.1	11.1	3.11	40
H&S Preliminaries in the BoQ	0.0	11.1	11.1	11.1	33.3	22.2	11.1	2.78	41
Worker 'pressure'	0.0	0.0	33.3	22.2	22.2	11.1	11.1	2.44	42
Compensation insurance provider 'pressure'	0.0	11.1	11.1	33.3	33.3	11.1	0.0	2.22	43
Union 'pressure'	0.0	0.0	55.6	11.1	22.2	0.0	11.1	2.00	44

The Compensation for Occupational Injuries and Diseases (COID) Act is the sister act to the OH&S Act and informs with respect to the mechanics of workers' compensation insurance, and the degree of compensation. The National Constitution constitutes the overarching legislation in South Africa, and makes reference to the right of a safe environment, which includes a persons' home, social, and work environments,

Construction Management issue (MS = 4.00) is ranked 16th. This is notable as it is such an issue, but not necessarily accordingly appreciated. The promulgation of the Construction Regulations, which requires the appointment of part-time or full-time H&S Officers has led to the perception, in cases, that 'H&S is the H&S Officer's responsibility'. Marketing edge / advantage (MS = 4.00) is ranked 18th and H&S specification (MS = 3.89) is ranked 19th. Previous research has indicated that optimum H&S does provide a marketing edge / advantage (Smallwood, 2005) and H&S specifications should constitute a useful guide (Smallwood, 2007). The converse of the impact of optimum H&S, in the form of the 'negative impact of poor H&S on' are ranked 21st, 25th to 27th, and 30th and 31st: productivity (MS = 3.89); cost, productivity, and schedule (MSs = 3.78), and quality and environment (MSs = 3.67). A range of research findings have addressed and quantified the negative effect of poor H&S (cidb, 2009). Within the aforementioned cluster, DoL enforcement of legislation & regulations (MS = 3.86), and resulting client satisfaction and corporate social responsibility (CSR) (MSs = 3.78) were ranked 23rd and 24th. Many clients champion H&S and thus include client specific H&S requirements in H&S Specifications and other project documentation, and therefore optimum H&S is a pre-requisite for satisfaction. H&S is one of the triple bottom-line reporting themes of CSR, and therefore if organisations include CSR in their corporate strategy, then it will serve as a motivator. Other Regulations (MS = 3.71 and resulting worker satisfaction (MS = 3.67) were ranked 28th and 29th. Workers are provided with working environments, which if unsafe or unhealthy, detract from satisfaction. These

were followed by resulting designer satisfaction and 'I am my brother's / sister's keeper' (MSs = 3.56) ranked 32nd and 33rd, and detailed inclusion of H&S in contract documents and client 'pressure' (MSs = 3.44) ranked 34th and 35th. Designers are responsible for aspects of completed buildings and structures and therefore, *inter alia*, temporary works, which have safety implications are inadequate, both H&S and designer satisfaction will be compromised. 'I am my brother's / sister's keeper' is the common thread in all religions and implies that people should consider their fellow humans, in the workplace included. Detailed inclusion of H&S in contract documents will facilitate financial provision for H&S and 'level the playing fields' in that doing so will ensure all tenderers / bidders make allowance therefore. The contribution of client 'pressure' in terms of enhancing contractor performance is well documented.

6 / 44 (13.6%) MSs fall within the range $> 2.50 \leq 3.33$, which indicates the 'motivators' can be deemed to have contributed to respondents' organisations addressing H&S between a near minor extent to some extent / some extent. Client requirements, cost of accidents, and economic benefits of H&S (MSs = 3.33) are ranked 36th to 38th, and employer association guidance (MS = 3.14), cost of compensation insurance (MS = 3.11), and H&S Preliminaries in the BoQ (MS = 2.78) are ranked 39th to 41st. The contribution of client requirements is similar to that of client 'pressure' in terms of enhancing contractor performance. The percentage the cost of accidents constitutes of the cost of construction, exceeds the contribution of the cost of H&S thereto. The economic benefits of H&S is attributable to, *inter alia*, the catalyst role H&S plays relative to the other performance parameters. Employer associations visit contractor members' sites and guide and assist them. Should contractors' compensation insurance claims as a percentage of assessments exceed a certain percentage they can be penalised. Conversely, they can be awarded rebates in recognition of a low claims ratio. The contribution of H&S Preliminaries in the BoQ is similar to that of detailed inclusion of H&S in contract documents.

The last 3 / 44 (6.8%) MSs fall within the range $> 1.70 \leq 2.50$, which indicates the 'motivators' can be deemed to have contributed to respondents' organisations addressing H&S between a minor to near minor / near minor extent. Worker 'pressure' (MS = 2.44), compensation insurance provider 'pressure' (MS = 2.22), and union 'pressure' (MS = 2.00) are ranked 42nd to 44th. These 'motivators' are unlikely to have contributed a major extent as the respondents' organisations' H&S competition achievements indicate commitment.

Anglo American plc (2014), the giant South African mining group, includes safety and health as a one of four 'pillars of value' and uses seven key performance indicators to measure performance relative thereto. The lost-time injury frequency rate (LTIFR) is a rate, per 200 000 hours worked, of employee and contractor lost-time injuries due to all causes. Their rate reduced from 0.58 in 2012 to 0.49 in 2013. These rates effectively mean that there were 0.58 and 0.49 such injuries per 100 workers per year respectively. It should be noted that according to the Construction Industry Development Board (cidb) (2009) the average LTIFR for the South African construction industry is 0.98. Given Anglo American plc's improvement in H&S performance over a period of years, it was deemed appropriate to interrogate their safety journey model as depicted in Figure 1 below. Therefore, the model was included in the survey and respondents were required to indicate whether they agreed that the model represented their organisation's H&S development. The MS of 4.33 in

Table 3 indicates that the concurrence is between agree to strongly agree / strongly agree (Strongly disagree = SD; Disagree = D; Neutral = N; Agree = A; Strongly Agree = SA).

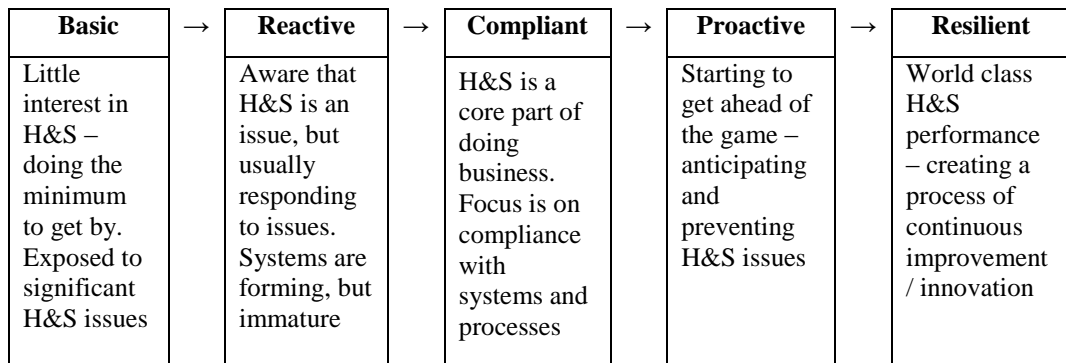

Figure 1: Anglo American plc's Safety Journey Model

Table 3: Extent to which respondents agree the model represents their organisation's H&S development

Response (%)					Mean
SD	D	N	A	SA	Score
0.0	0.0	11.2	44.4	44.4	4.33

Respondents were then requested to indicate their organisation's current H&S status. Although the use of a MS can be debated, the MS of 3.88 indicates that the general status is between compliant and proactive / proactive. In terms of percentages, 37.5% identified 'resilient'.

Table 4: Respondents' organisations' current H&S status

Response (%)					Mean
Basic	Reactive	Compliant	Proactive	Resilient	Score
0.0	12.5	25.0	25.0	37.5	3.88

Table 5 indicates the extent to which respondents concur with statements relative to their organisations' H&S. MSs > 3.00 ≤ 5.00 indicate agreement as opposed to disagreement.

It is notable that no statements attracted concurrence between agree to strongly agree / strongly agree (> 4.20 ≤ 5.00). 11 / 14 (78.6%) Statements attracted concurrence between neutral to agree / agree (> 3.40 ≤ 4.20). The role of synergy is reflected in the statement 'The positive impact of optimum H&S on overall performance promotes increased focus on H&S'. The evolutionary nature of H&S is reflected in the statements 'Improving H&S performance is progressive' and 'The journey to optimum H&S is progressive'. 'Fatalities promote increased focus on H&S', 'Incidents promote increased focus on H&S', 'Accidents promote increased focus on H&S', 'Disabling injuries promote increased focus on H&S', 'The uninsured costs of accidents promote increased focus on H&S', and 'The negative impact of poor H&S

on overall performance promotes increased focus on H&S' indicate the role of negative experiences in terms of motivating the addressing of H&S.

Table 5: Extent to which respondents agree with various statements

Statement	Response (%)					MS
	SD	D	N	A	SA	
The positive impact of optimum H&S on overall performance promotes increased focus on H&S	0.0	0.0	11.1	66.7	22.2	4.11
Improving H&S performance is progressive	0.0	0.0	0.0	88.9	11.1	4.11
The journey to optimum H&S is progressive	0.0	0.0				
Fatalities promote increased focus on H&S	11.1	11.1	0.0	22.2	55.6	4.00
Incidents promote increased focus on H&S	0.0	0.0	11.1	88.9	0.0	3.89
Organisations initially address H&S due to legislation	0.0	11.1	0.0	88.9	0.0	3.78
Accidents promote increased focus on H&S	0.0	11.1	0.0	88.9	0.0	3.78
Disabling injuries promote increased focus on H&S	0.0	22.2	0.0	66.7	11.1	3.67
Employer associations promote focus on H&S	11.1	0.0	11.1	77.8	0.0	3.56
The uninsured costs of accidents promote increased focus on H&S	0.0	22.2	22.2	44.4	11.1	3.44
The negative impact of poor H&S on overall performance promotes increased focus on H&S	0.0	11.1	33.3	55.6	0.0	3.44
The insured costs of accidents promote increased focus on H&S	0.0	22.2	33.3	33.3	11.1	3.33
The DoL Inspectorate promotes focus on H&S	0.0	22.2	33.3	44.4	0.0	3.22
Clients promote focus on H&S	22.2	11.1	22.2	33.3	11.1	3.00

'Organisations initially address H&S due to legislation' amplifies the role of legislation, and 'Employer associations promote focus on H&S' indicates the role of 'convincing' contractors to address H&S.

3 / 14 (21.4%) Statements attracted concurrence between disagree to neutral to / neutral ($> 2.60 \leq 3.40$). 'The insured costs of accidents promote increased focus on H&S' once gain indicates the role of negative experiences in terms of motivating the addressing of H&S. 'The DoL Inspectorate promotes focus on H&S' amplifies the role of the enforcement of legislation, and 'Clients promote focus on H&S' indicates that clients are not promoting focus on H&S as intended in the Construction Regulations.

CONCLUSIONS

Despite the 64.3 % response rate, the study entailed a small sample, and therefore can best be deemed as exploratory, with a view to an expanded sample. Therefore the findings cannot be deemed representative, but indicative, remembering that the intention was to determine whether 'better practice' H&S contractors or contractors that achieve high levels of performance follow an evolutionary process in terms of H&S performance, or not.

Given that cost, schedule, quality, and productivity are ranked higher than H&S in terms of importance it can be concluded that GCs are likely to view the traditional project parameters as more important than H&S for the foreseeable future. This amplifies the need to motivate H&S on the basis of the positive impact optimum H&S has on performance relative to the other project parameters, and the negative impact poor H&S has on performance relative to the other project parameters.

Based upon the extent to which ‘motivators’ contributed to respondents’ organisations addressing H&S, the following conclusions can be drawn. The ranking of the OH&S Act and Construction Regulations leads to the conclusion that legislation constitutes a primary motivator. The COID Act and the National Constitution are also ranked high. The ranking of image, professionalism, and reputation leads to the conclusion that there is understanding and appreciation of the holistic role of H&S. The ranking of H&S as an organisation value, and H&S as a moral issue, leads to the conclusion that although legislation is important, H&S is a moral issue. This is reinforced by the high ranking of preservation of organisational integrity. The positive impact optimum H&S has on performance relative to the other project parameters, and the negative impact poor H&S has on performance relative to the other project parameters leads to the conclusion that the GCs are aware of the synergistic effect of optimum H&S and have made a paradigm shift from ‘compliance with legislation’ to ‘H&S is a profit centre’. This is reinforced by the ranking of marketing edge / advantage.

The respondents’ agreement that their organisation’s H&S development had followed the presented model ‘Basic → Reactive → Compliant → Proactive → Resilient’ leads to the conclusion that H&S development and performance is stage based and evolutionary. Therefore, unless a contractor successfully completes the prior stages, progression will not occur, and premature motivation on the basis of the benefits that accrue at the next level is necessary to engender such progression.

This has implications for those promoting H&S, in particularly when endeavouring to engender progression to the proactive and resilient stages. To reach the resilient stage will require a holistic approach to promoting H&S, and increased focus on and commitment of resources to H&S.

RECOMMENDATIONS

A multi-faceted approach should be adopted when promoting H&S. This applies to the DoL Inspectorate, employer associations, employee associations, construction managers, and H&S consultants. Obviously legislation should be cited and referred to when promoting H&S, however, the moral rationale for addressing H&S should feature prominently in tandem with the upholding of reputation and image, and consequent marketing benefits. Then, the synergistic benefits of H&S should always be cited. However, in order to realise self-reinforcement of the promotion of H&S on the aforementioned basis, on-going research relative to the benefits of H&S must be conducted.

REFERENCES

- Anglo American plc (2014). “Anglo American plc Sustainable Development Report 2013”. London: Anglo American plc.
- Construction Industry Development Board (cidb) (2009) “Construction Health & Safety in South Africa Status & Recommendations”. Pretoria: cidb.

- Hinze, JW (2006) "Construction Safety", 2nd Edition. New Jersey: Prentice Hall Inc.
- Ikpe, E, Hammond, F, Proverbs, D and Oloke, D (2011) Improving Construction Health and Safety: Application of Cost-Benefit Analysis (CBA) for Accident Prevention. "The International Journal of Construction Management", 11(1), 19-35.
- Smallwood, JJ (2004) Optimum cost: The role of health and safety (H&S). In: Verster JJP, ed. "Proceedings International Cost Engineering Council 4th World Congress", Cape Town, April 2004. International Cost Engineering Council, 2004: CD-Rom
Smallwood-J- Optimum Cost-Health & Safety.pdf
- Smallwood, JJ (2005) The Role of Optimum Health and Safety (H&S) in Construction Marketing. In: F. Khosrowshahi (ed.) "Proceedings of 21st Annual Conference of ARCOM". SOAS, London, 7-9 September 2005. Reading: ARCOM, 1 097-1 106.
- Smallwood, JJ (2010) The Image of Contractors: A South African Case Study. In: C. Egbu (ed) "Proceedings of 26th Annual Conference of ARCOM". Leeds, 6-8 September 2010. Reading: ARCOM, 939-946.
- Wright, M and Marsden, S (2002) "Changing business behaviour - would bearing the true cost of poor health and safety performance make a difference?" Norwich: Health and Safety Executive.
- Zwetsloot, GIJM van Scheppingen, AR, Bos, EH, Dijkman, A and Starren, A (2013) The Core Values that Support Health, Safety, and Well-being at Work. "Safety and Health

CLIMATIC HEAT RISK MANAGEMENT IN CONSTRUCTION: A SOCIO-ERGONOMIC THEORY

Steve Rowlinson^{1,2} and Yunyan Andrea Jia³

- 1. Key laboratory of Eco-environment in Three Gorges Reservoir Region under Ministry of Education, Faculty of Urban Construction and Environmental Engineering, Chongqing University, Chongqing, China*
- 2. Department of Real Estate and Construction, The University of Hong Kong, Pokfulam, Hong Kong*
- 3. Australasian Joint Research Centre for Building Information Modelling, School of Built Environment, Curtin University, Perth, Australia*

Abstract: [Theoretical models have been developed for decades in the ergonomics field for understanding the mechanism of heat stress in working environment and development of heat strain in human body. They are however disconnected with management practice where large working population is exposed to climatic heat stress in summer, such as in the context of construction industry. Existing heat stress management in construction sites is being practised in an incremental way, which results in conflicting effects in safety measures. For example, the safety helmet, intended to protect workers from falling objects, often acts as a head heater during hot summer, which puts workers in a dilemma of risking one hazard or another. There is a lack of understanding on which systematic planning could be developed for heat stress management in construction sites. Noting this gap, this paper presents an initial theory that grounded the ergonomic heat stress model into its managerial, social and institutional context of the construction industry. The socio-ergonomic theory is generated from physiological, environmental and interview data from 34 heat illness cases out of a sample of 216 workers of 26 construction sites in Hong Kong over 69 summer days. Using the existing rational ergonomics model of heat stress mechanism as a core, primary causes of heat illness in construction sites are identified, based on which effective interventions and their enablers at management and industrial levels are sorted. The theory serves to explain and predict climatic heat risks and its mitigation measures. Practically it serves to guide systematic assessment, monitoring and mitigation of heat stress risks in construction sites. The theory is open for modification and further development through cross-regional comparative studies]

Keywords: climatic heat stress, continuous work time, socio-ergonomic theory, intervention, acclimatisation.

INTRODUCTION

One of the effects of global climate change is a general increase in ambient temperature. In Hong Kong, ambient temperature is seen to be increased by 0.2 °C per decades (HKO, 2013; Li, 2009). The need for adaptation to climate change, which involves adjustment of work and life regimes for safety, health and well-being, brings the management of occupational heat stress to a priority of the global research agenda (Kjellstrom, Gabrysch, Lemke, & Dear, 2009).

The bulk of literature discusses extreme weather as one of the construction project risks based on the observation that storm or hurricane leads to project delay. The situation of hot weather, perceived as a routine of seasonal change, is however often ignored in the list of risks due to a lack of established path of causality. Despite summer recorded a highest accident rate of the year since the 1970s (Helander, 1980), information on the thermal environment is rarely present in accident reports.

In the ergonomics field, models for understanding the mechanism of heat stress in working environment and development of heat strain in human body have been developed for decades. By the 1980s it has been commonly agreed among ergonomists that heat strain is predicted by six heat stress factors including (1) air temperature, (2) humidity, (3) solar radiant heat and (4) wind speed, (5) metabolic heat, and (6) clothing effect (Parsons, 1995). Heat stress threshold limit values based on this rationale (e.g. ACGIH, 2003) was incorporated into construction manuals (CSAO, 2007) for tackling heat stress in construction sites. The threshold system was however found to be unrealistic and counter-productive therefore is not implemented. The underlined problem with this paralysed implementation can be found in the postulation of ergonomics, which assumes an incumbent of thermal effect isolated from its socio-psychological context shaped by managerial practice. Whilst this model provides a precise framework analysing heat exchange between individual body and its immediate thermal environment, it is however disconnected with management practice where large working population is exposed to climatic heat stress in summer. In the context of construction site, for example, metabolic heat can be further traced down to two manageable factors, i.e., continuous work time and work pace (Rowlinson & Jia, 2014; Rowlinson, Jia, Li, & Ju, 2014). Provided a scientific understanding of causalities, interventions can be developed in the workplace to prevent the consequence of heat stress in a project team.

More often than not, heat stress management in construction sites is practised in an incremental way, which results in conflicting effects in safety measures. For example, the safety helmet, designed to protect workers from falling objects, often acts as a head heater during hot summer, which puts workers in a dilemma of risking one hazard or another. A knowledge gap is to be bridged based on which systematic planning could be developed for effective mitigation of climatic heat stress risks in the occupational setting of construction workers. Existing research on interventions focuses on laboratory test of specific effect of certain cooling method. For example, Fujii et al (2008) tested the effect of head wash as an intervention of reducing heat stress and reported that the intervention group showed less sweat loss, lowered ear carnal temperature and skin temperature at forehead and hands but not in rectal and oesophageal temperatures, nor in stabilometry and visual reaction time than the controlled group. Whilst the research rationale may enrich the understanding in the ergonomics point of view, it may not be valid in explaining the effect of such interventions in a complex working context where many factors interact, multiply, or even reverse the effect of each other.

The on-going research investigates heat stress risks and practices of intervention in construction site in Hong Kong. The aim of the research project was to update guidelines (CIC, 2008) for construction industry on management of heat stress in construction workers working in hot and humid weather. While the updated guidelines have been issued recently (CIC, 2013), empirical research underpinning the updated guidelines is partially presented in this paper. The empirical study investigated heat

risks in construction sites, what interventions are being practised on site, their effectiveness and impact. Specifically, the investigation was guided by three enquires:

- What are the primary causes of heat illness incidents happened in construction sites in Hong Kong?
- To what extent have the interventions are being practised on site effectively addressed these risk factors?
- What are the enablers and constraints of effective interventions in construction projects in Hong Kong?

METHODOLOGY

The research adopted a grounded theory approach as the overall strategy. The scope of the theory generation is narrowed down and focused on causes, intervention and their enablers in on-site heat illness. The six factors in ergonomics model served as core categories in the theory generation process. Based on the ergonomic model, the basic task of heat stress management, at the individual level, is to control the six factors of heat stress in order to protect workers from excessive heat strain, specifically, to prevent body core temperature from rising above a safe limit, thus prevent heat illness and fatality (ACGIH, 2009; NIOSH, 1986). This model is used as core categories in our theory generation.

Sampling

Ideally, the grounded theory approach favours theoretical sampling, in which the sampling is structured by the progressively derived theory (Strauss, 1987). This time-consuming process is hardly realistic for the seasonal constraint of heat stress study. Within a budget of time, we collected data with a survey method, embedded in an ethnographic approach, to obtain a pool of cases for purposeful comparison. Sampling of the survey was stratified by types of projects and trades of construction work. During the survey, critical incident technique (CIT) was employed to elicit individual heat illness experiences (Flanagan, 1954; Tuuli & Rowlinson, 2010).

Data collection

Data of this study includes quantitative data from questionnaire survey, environmental and physiological data through direct measurement, field notes from site observation, focus group interviews, semi-structured individual interviews, discussion, and structured interviews. Data collection was conducted with a combination of ethnographic and survey methods. A two-day protocol was developed from pilot study to guide on-site data collection. The protocol was designed to allow a progressive trust building process between the researcher and the participants. Structured interview was scheduled in the last session.

Data analysis

Based on contextualised information on 34 cases of on-site heat illness, a typology of primary causes of on-site heat illnesses was derived through theoretical sampling and comparative analysis of individual cases. Triangulation of multiple data sources was used to construct the context and effectiveness of the implemented interventions. These include record of environmental parameters and physiological data, contextual data from interviews, managers' evaluation of the working condition and researcher's field notes of passive observation.

Instruments

Questionnaire design is based on an initial guidelines issued in 2008 (CIC, 2008) and a pilot study on the effectiveness of safety measures recommended in the initial guidelines in 2010. Three versions of questionnaires were designed to target different sources of information: (1) a worker's questionnaire and (2) a manager's questionnaire for collecting data of these two groups of population's perceived heat risks and effectiveness of interventions; and (3) a site checklist, including all the intervention measures for researchers to tick whether these interventions are implemented or not, through passive observation of each construction site. The three tools share a set of core questions, i.e., the items of interventions. The questionnaires also served as guidelines for structured interview with worker participants.

FINDING AND DISCUSSION

Sample

Physiological data were obtained from 216 worker participants, among which 207 filled in the questionnaires. In addition, questionnaires were obtained from 96 managers and 26 construction sites. Among the 216 individual cases, 38 reported critical incidents on personal experience of heat illness on site. Excluding four critical incidents that reported cases of other people, 34 valid heat illness cases were obtained.

Experienced symptoms of heat illness

The reported heat disorders covered the whole range from heat rash to heat stroke. Specifically, experienced symptoms of heat illness include heat rash, fatigue, thirst, discomfort, breathing difficulties, cramp, dehydration, over-sweating, dizziness, dry and hot skin, fever, headache, vomiting, loss of control, fainting, no sweating, heat stroke.

Time of heat illness incidents

29 workers in the sample gave a specific indication of time slots of higher heat risk on a summer day on site. The highest frequency of heat illness incidents were found in 11 am and 2-3 pm. No incident was reported after 4pm.

Initial analysis on demographic and personal factors

Among the demographic factors, age was found to have a consistent pattern in association with on heat illness cases. The pattern was however contrary to common beliefs. The highest percentage (23.7%) is found in the age group of 26-35. Percentages of heat illness cases decrease, instead of increase, with the increase of age groups. This is probably due to the mismatch between workers' actual physical fitness and their estimation of what they can, which is most prominent at an age when body physical capacity starts to deteriorate while the mind's estimation of risk lags behind. As people get more mature and experienced, the gap between perception and actual condition is narrowed down. Meanwhile, the construction workforce as a whole undergoes a demographic change with the ageing process through which unfit people are gradually wielded out (Marchant, 2013). No consistent trend was found between other demographic and personal factors and heat illness incidents. The results suggest the complexity of heat stress problem in the context of construction management. As human being is an active agent that responses automatically to the environment through both physiological and behavioural adaptations, the actual occurrence of heat

illness on-site reflects more of the social effects than predicted by an objective ergonomic model.

Primary causes of on-site heat illness cases and effective interventions

A primary cause of incident is defined as the most prominent factor leading to heat illness incidents.

From a systemic point of view, a pre-condition of identifying a risk is to determine boundary condition tells where a deviation happens (Rasmussen, 1997). For heat stress management, the boundary conditions to be identified are thresholds that ensure individual's body core temperature do not exceed a safe limit (Rowlinson et al., 2014). In this study, boundaries in environmental, workload and work pace conditions are identified using the tools for producing thresholds in WBGT for paced work and limiting metabolic rate for self-paced work developed by Rowlinson and Jia (2014). Change analysis identified six primary causes from the 34 critical incidents, including (1) climatic heat stress (air velocity, solar radiation, humidity), (2) machine generated heat stress, (3) continuous work time (CWT), (4) acclimatisation, (5) fatigue, and (6) personal factors. Using the identified risk factors as a framework, interventions were further investigated, followed by identification of their enabling/constraining conditions. Results were elaborated in theory generation, reported as follows.

Climatic heat stress

Three factors are identified under climatic heat stress in construction sites: low air velocity, high humidity and strong solar radiation. The three factors are to be understood as characteristics of hotness, or, types of hotness, rather than as separate isolated constructs. Hotness characterised by low air velocity was found in three conditions in construction work in summer: tunnelling work, work in confined space or in a weather of stilled wind. Similar situations include a semi-confined space such as a shaft, building projects at the stage of glazing or fitting HAVC, building in demolition covered with protective screens, etc. It is notable that a particular hot and still-wind weather is also having the same level of risk with a confined space. Hotness characterised by strong solar radiant heat is found among the physically demanding work trades, such as rebar workers, carpenters and concretors. On-site rebar work often cannot be shaded when steels are lifted by the crane. A best practice is found in a large civil engineering site where bar bending work was automated in an on-site factory. Carpenter or concretor working at rooftop has limited strength of shades. Hotness characterised by high humidity was found in construction sites in the seaside or in mountain slope in the oceanic climate of Hong Kong.

Adoption of engineer control, including blowers, ventilation pipes, electrical fans, canopies or other simple temporary shades, and air-conditioned rest place, has been effective in combatting the three types of hotness. However, not all of them are applicable to workplaces of all trades. Some are only applicable to rest places, and they have to be matched by rest time to be effective. Additional rest time demands additional labours to keep the level of productivity. A more systemic intervention is to reduce on-site work through off-site pre-fabrication. This is constrained by project cost and enabled by supply chain integration.

Work generated heat stress

Work generated heat stress is a heat stress source independent from climatic heat stress. This category includes both the heat directly generated by the working equipment and that generated by vehicles at the workplace. Engineering control such

as exhaustive pipes and insulation of heat source was effective in certain conditions. Yet in cases where heat sources were not under control within the scope of work, e.g., roadside work with vehicle discharged heat, the risk is to be handled by temporal interventions, i.e., work-rest regimen, to reduce continuous exposure time. A constraint for temporal intervention is project priority.

Continuous work time (CWT)

Primary causes of two of the heat illness cases were attributed to long CWT, or, to describe it another way, lack of break. Constraint for more rest time is productivity pressure of projects and shortage of labour in Hong Kong. However, finding from the series of research suggest productivity can be maintained if work-rest regimen is carefully planned on a scientific base.

Acclimatisation

Lack of acclimatisation is found to a primary cause of heat illness among well-experienced workers in good fitness and health. Acclimatisation is constructed in two dimensions, physical and mental acclimatisation. The two dimensions are not independent to each other. The results show that acclimatisation involves both physiological change within the body and sensation change in the mind such that the acclimatised worker is more sensible in perception of the risk and adjustment of his or her work pace to keep the body within the safe limit.

There are generally no formal acclimatisation procedures implemented in construction site. A few of them have informal acclimatization but the time is far shorter than required for a full acclimatisation. Not surprisingly it was seen as a common phenomenon for newcomers, as said by an experienced worker: *“New comers are not used to sunlight. They come to site and vomit immediately.”*

Moreover, acclimatisation problem is also found when the work is discontinuous.

“During economic recession, there were not enough jobs to do. I had to work as day labour on site whenever I got a chance. The chances are around two or three days a week. Often I was not used to the hot weather and worked too hard to keep the balance of my body, and got beaten by the heat.”

The mental dimension of acclimatisation is dependent on workers' knowledge of heat stress risks and their own health. This kind of knowledge will enable the worker to keep himself or herself hydrated, slow down work pace when the environmental hotness increases, and make timely response to early signs of heat illness. A worker experienced heat illness on site after ten years' off from construction work. His self-reported causes were “not drinking enough water, overworked under strong sunlight, and continuing work at presence of feeling nausea and dizzy”. It is clear that the incident is not a consequence of discrete factors but rather, a consequence of lack of mental acclimatisation.

Physical acclimatisation protocol for new comers and for workers left work for more than a week is not found in routine practice but in some informal way. Meanwhile induction and refreshment training and informal reminders are effective interventions for mental acclimatization. Constraints for these practices are productivity pressure, shortage of labour, fluctuation of job market with economics which resulted in discontinuous work of individual workers, lack of scientific knowledge of acclimatization in construction sites. Meanwhile provision and accessibility of drinking water is an enabler of the intervention.

Fatigue

Fatigue is found to be a primary cause of heat illness. In this sample, reported fatigue occasions are all related to inadequate sleep due to long working hours, travelling time or other off-work activities spill-over to workers' sleep time. Managerial decision on extended lunch break, which allows a nap, is identified as an effective intervention. Implementation of this intervention is however contained by productivity concerns, as limited time is available in compensation of the production time cut for extension of lunch break due to another statutory control on construction noises in Hong Kong, which specifies no construction work is allowed "between the hours of 7 p.m. and 7 a.m." (CAP 400, Section 6).

Personal factors

Personal factors identified in this sample include age, latent health problem and poor physical fitness. Triangulating with the findings in demographic analysis, the result should be interpreted as a combination of several disadvantages in personal factors lead to heat illness in construction work, rather than any of discrete single factor is having a determinant influence on the occurrence of heat illness.

CONCLUSION

Through a systemic approach, the grounded theory generated from this data identifies six primary causes of heat illness incidents in construction sites in Hong Kong. The identified primary causes then served as a theoretical framework to guide further investigation of effective interventions, which guided identification of their enablers and constraints. Findings of this study suggest that existing interventions were focused on climatic heat, work generated heat and continuous work time. The issues of fatigue, acclimatization and personal factors had not been effectively addressed constrained by productivity pressure and economic environment of Hong Kong. Comparing with the rational individual based ergonomic model, this model separated climatic heat and work-generated heat for recognition of their different characteristics and mitigation strategies. Moreover, continuous work time, fatigue, acclimatisation and personal factors come to be prominent variables that play a role in the development of heat illness incidents rather than background conditions of environmental heat. Fatigue and acclimatisation are re-conceptualised, through which the concept of fatigue is more focused and the concept of acclimatisation is broadened to include mental acclimatisation.

The initial theory explains how heat stress factors play a role in the working conditions of construction site to help prediction climatic heat risks and planning of its mitigation measures. Practically it serves to guide systematic assessment, monitoring and mitigation of heat stress risks in construction sites. The theory is open for modification and further development through cross-regional comparative studies. This study limits its scope in analysing heat illness cases, but not all on-site incidents related to heat stress. Other accidents related to despaired concentration in heat are not in the scope of this study but merit further investigation.

Fatigue is found to be both a symptom of, and a risk leading to, heat illness. This suggests a potential effective intervention through worker's self-monitoring and self-adjustment in response to fatigue as an early sign of heat-related disorder, to prevent further development of heat stroke. This can be an area of further research.

REFERENCES

- ACGIH. (2003). *2003 Threshold Limit Values and Biological Exposure Indices for Chemical Substances and Physical Agents*. Cincinnati, Ohio: American Conference of Governmental Industrial Hygienists.
- ACGIH. (2009). *Documentation of the Threshold Limit Values and Biological Exposure Indices (7th Ed.)*: American Conference of Governmental Industrial Hygienists.
- CAP 400. Noise Control Ordinance. *Hong Kong S.A.R.*
- CIC. (2008). *Guidelines on Site Safety Measures for Working in Hot Weather*. Hong Kong: Construction Industry Council.
- CIC. (2013). *Guidelines on Site Safety Measures for Working in Hot Weather (Version 2)*. Hong Kong: Construction Industry Council.
- CSAO. (2007). *Construction Multi-Trades Health and Safety Manual*. Etobicoke: Construction Safety Association of Ontario.
- Flanagan, J. C. (1954). The critical incident technique. *Psychological Bulletin*, 51(4), 327-358.
- Fujii, Ronaldo Kenzou, Horie, Seichi, Tsutsui, Takao, & Nagano, Chikage. (2008). Effectiveness of a head wash cooling protocol using non-refrigerated water in reducing heat stress. *Journal of Occupational Health*, 50, 251-261.
- Helander, Martin. (1980). Safety challenge in the construction industry. *Journal of Occupational Accidents*, 2, 257-263.
- HKO. (2013). *Observed Climate Change in Hong Kong: Temperature*. Hong Kong Observatory: http://www.hko.gov.hk/climate_change/obs_hk_temp_e.htm, accessed on 12 August 2013.
- Kjellstrom, Tord, Gabrysch, Sabine, Lemke, Bruno, & Dear, Keith. (2009). The 'Hothaps' programme for assessing climate change impacts on occupational health and productivity: an invitation to carry out field studies. *Global Health Action*(DOI: 10.3402/gha.v2i0.2082).
- Li, Rita Yi Man. (2009). The impact of climate change on residential transactions in Hong Kong. *The Built & Human Environment Review*, 2(1).
- Marchant, Teresa. (2013). Keep going: career perspectives on ageing and masculinity of self-employed tradesmen in Australia. *Construction Management and Economics*, 31(8), 845-860.
- NIOSH. (1986). *Criteria for a Recommended Standard - Occupational Exposure to Hot Environments*. Washington DC, USA: National Institute for Occupational Safety and Health, DHHS (NIOSH) Publication No. 86-113.
- Parsons, Kenneth C. (1995). International heat stress standards: a review. *Ergonomics*, 38(1), 6-22.
- Rasmussen, Jens. (1997). Risk management in a dynamic society: a modelling problem. *Safety Science*, 27(2/3), 183-213.
- Rowlinson, Steve, & Jia, Yunyan Andrea. (2014). Application of the Predicted Heat Strain Model in development of localized, threshold-based heat stress management guidelines for the construction industry *Annals of Occupational Hygiene*, 58(3), 326-339. doi: 10.1093/annhyg/met070

- Rowlinson, Steve, Jia, Yunyan Andrea, Li, Baizhan, & Ju, Chuanjing Carrie. (2014). Management of climatic heat stress risk in construction: a review of practices, methodologies, and future research. *Accident Analysis and Prevention*, 66, 187-198.
- Strauss, Anselm L. (1987). *Qualitative Analysis for Social Scientists*. Cambridge: Cambridge University Press.
- Tuuli, Martin Morgan, & Rowlinson, Steve. (2010). What empowers individuals and teams in project settings? A critical incident analysis. *Engineering, Construction and Architectural Management*, 17(1), 9-20.

THOUGHT CONSISTENCY QUESTIONS IN SAFETY CLIMATE SURVEYS: A CASE STUDY EXAMPLE

David Oswald³⁴, Fred Sherratt³⁵ & Simon Smith¹

¹ *University of Edinburgh, King's Buildings, West Mains Road, Edinburgh, EH9 3JN, UK*

² *Anglia Ruskin University, Bishop Hall Lane, Chelmsford, CM1 1SQ*

Safety climate surveys are often used on large construction projects in an attempt to understand, improve and track the safety culture. This investigation is based on two safety climate surveys conducted 6 months apart on a very large (+£500m) UK civil engineering project. The aim of this study is to explore the validity of the safety climate survey and the use of 'thought consistency' questions. 'Thought consistency' questions are questions which are asked more than once, usually in a different way, to act as a check or a trap. The findings from this study suggest that the 'thought consistency' questions that were personalised (such as 'my safety matters more than money to my employer' rather than 'safety always comes first, even if it affects profit or productions') gained a different response than impersonalised questions. Therefore, even though the question appears very similar, if not the same but worded differently, the results varied due to the personalised nature of the question. The content validity of the survey was analysed using Lawshe's content validity ratio. This check was not only useful for measuring the content validity but identified questions that were perhaps not necessary. The survey highlighted a particular department as an area for concern, since it had shown poorer safety attitudes than the rest of the project. As poorer attitudes are linked to an increase in likeliness of accidents and incidents, the accident-incident register for a 6-month period after the survey was scrutinised. This particular department that was highlighted (35% of the total respondents) was found to have far more accidents and incidents than all of the other departments combined, suggesting that, to a certain degree, the survey was able to forecast future trends.

Keywords: Construction, Forecasting, Personalised Questions, Validity

INTRODUCTION

Safety climate surveys are a relatively new way for construction companies to measure and track their safety climate. The content within safety climate surveys in the industry is extremely varied, which ultimately affects how well the survey can predict future trends. The first aim of this paper was to investigate the importance of the wording on questions that were used as a check, sometimes known as 'thought consistency' questions. The second aim was to explore the content validity of the

³⁴ D.Oswald@ed.ac.uk

safety climate survey used on a large construction project and to establish whether this survey could predict future trends.

‘Organisational climate’ first came to light in the 1970s and referred to a global concept underlying the events and processes of an organisation (Guldenmund, 2000). During the 1980s this concept became known as ‘organisational culture’ and nowadays this is the case, with ‘organisational climate’ being a manifestation of ‘organisational culture’. Safety culture is essentially a subculture of organisational culture, where the three levels of organisation culture (artefacts and behaviours, espoused values and assumptions) (Schein, 2004) can equally be applied to safety culture (Whittingham, 2012). Safety climate is seen as similar to safety culture and the terms are often used interchangeably, but researchers have tried to highlight the differences in the terminology.

LITERATURE REVIEW

Safety Culture v Safety Climate

Safety culture is seen as a more embracing term than that of safety climate. Guldenmund (2000) suggests that safety climate refers to the organisations attitudes towards safety, while safety culture is more than that, embracing concerns with underlying beliefs and convictions of those attitudes. He concludes that safety climate could be used as an alternative measure to safety culture. In Zohar’s (1980) well-established work he used safety climate to describe a construct that captured the employee’s perceptions on the role of safety within the organisation. Various other definitions have been alluded to including Budworth’s (1997) more literal meaning of the ‘safety temperature’ within the organisation. Climate was described by Glendon & Stanton (2000) as more superficial and it is now accepted that safety climate is a surface expression of safety culture (Wamuziri, 2013). The definition of safety culture is not universal either, with explanations ranging from a simple short-hand term for an organisations ‘culture of safety’ or those ‘cultural influences impacting safety’ (Hale, 2000) while the Health and Safety Commission (1993) has a more detailed definition of safety culture:

‘The product of individual and group values, attitudes, perceptions, competencies, and patterns of behaviour that determine the commitment to, and the style and proficiency of, an organization’s health and safety management.’

Guldenmund’s (2000) well received paper on safety climate and culture, gives a comprehensive review of all the used definitions of both phenomenon. Safety culture first made an appearance in the 1987 OECD Nuclear Agency Report following the devastating Chernobyl disaster in 1986. Following this report many enthusiastic researchers investigated the effects of safety culture in the work-place, with Pidgeon (1991) describing it as ‘the most important theoretical development in health and safety research in the last decade’. A poor safety culture has been identified as one of the main reasons as to why accidents have occurred on many different construction sites. From 100 random accidents that were investigated by the HSE (2003), it was concluded that safety culture contributed to over half of them. Hence, there has been significant research into this concept in modern times and various attempts to measure the three main components of safety culture: psychological, situational and behavioural. While situational aspects can be seen through the management systems, and behavioural aspects are measured by

techniques such as from observations and self-report measures; psychological components are commonly measured by questionnaire surveys.

Safety Climate Surveys

The construction industry traditionally has used accident rates and compensation statistics as methods of measuring its safety performance. Though these are important indicators, the 'softer' measuring techniques such as safety climate surveys remained largely ignored until after the millennium, with Mohamed in 2002 suggesting they were in their 'infancy'. In fact, before the millennium there was virtually no research examining factors such as safety climate in construction (Grubb and Swanson, 1999), despite Zohar's (1980) important work. Zohar's work coined the phrase 'safety climate' in the initial study of the phenomenon, which found that an employee's perception of management was the most important predictor of safety climate. Exploration into safety climate measures has increased in recent times and such measures have tended to be used as substitute measure of the safety culture. Safety climate surveys may have struggled to make an impact due to their 'soft' nature in what is undoubtedly a 'hard' industry. Nevertheless, there have been a few examples of where climate survey approaches have demonstrated considerable value in improving safety performance such as: Donald and Canter (1994) who found a set of scales, used in the chemical industry, that reliably measured safety attitudes and Carroll (1998) who used a nuclear plant case study example to show how surveys were used to identify problems within a departments safety culture. Though these successes support the use of safety climate surveys, there are limitations to this type of research. The survey method only provides a superficial description of culture within an organisation and practises are often too complex to be meaningfully described through wording in a survey (Hopkins, 2006).

Survey Validation

Validating a survey is of great importance. Fink (2002) in 'The Survey Handbook' highlights four types of validity: content, face, criterion and construct. This study focuses on content validity, face validity and one of the two subcategories of criterion validity, predictive validity. Content validity makes reference to the extent at which the survey has measured what it was intending to measure. Lawshes (1975) content validity ratio is a widely used measure of this. Face validity does not rely on an established theory but simply refers to how a measure appears on the surface. To establish face validity it is worth noting if all the relevant questions were asked and in the appropriate language. Criterion validity is the most complex type of validity which has two subcategories: predictive validity and concurrent validity. Predictive validity is the degree to which the survey can predict future trends. Concurrent validity occurs if the survey results correlate highly with an already validated survey.

Attempts have been made to validate safety climate measures, usually by comparison with retrospective accident data. Though there is logic to this validation process there are shortcomings to such a process due to issues with, for example, under-reporting. Nevertheless, it is not easy to derive an improved validation process. Quantified risk assessment calculations may be an alternate validation method as there is evidence that these align with workers risk perceptions on offshore oil platforms (Fleming et al., 1998). Results of validated studies are encouraging (Flin et al., 2000) but a comprehensive meta-analysis is required (Turner and Pidgeon, 1997) in order to eradicate any failing factors. Cheyne et al. (1999) found that a structural equation

modelling method is beginning to indicate which factors inter-relate and if they directly or indirectly influence unsafe behaviours.

Surveys often use quality control questions to check that their data. Such quality control questions can also be described as 'thought consistency' questions. Thought consistency questions usually ask the same or similar questions but worded in reverse. For example, one question could be 'I often get stressed at my work' and later ask 'usually I am relaxed in my work'. These questions are sometimes used as a 'trap', with those that give inconsistent or contradictory answers having failed (Downes Le-Guin et al., 2012).

Modelling Safety Climate

Questionnaire based methods are useful for gauging the safety climate of an organisation (Wamuziri, 2013) and there have been several attempts to model the safety climate of organisations using this research method, however thus far there is no accepted and unified model. Variance in modelling techniques is often due to the requirements and input from the sponsoring body (Flin et al., 2000), though there has been a few replications of independent questionnaires (e.g. Dedobbeleer and Beland, 1991). The wide range in styles (content, sample size and composition and method of analysis) of survey questionnaires has made it no simple task to compare findings, not only because of the methodological inconsistencies but also the language and cultural differences across countries and industries (Flin et al., 2000). A factor analysis has been typically used to identify the underlying structure, but researchers have found between two and nineteen factors that influence the safety climate. A result which led Coyle et al (1995) to state that it was 'highly doubtful' a universal and stable set of safety climate factors would be established.

RESEARCH APPROACH

In a seven-month period on a large construction project in the UK, two safety climate surveys were completed. The number of respondents increased by over 50% between the first and the second survey (n=309 and n=475). These two surveys were exactly the same, comprised of 128 questions and took around 15-20 minutes to complete. The first survey was completed in August 2012 by 309 respondents: 86% were male, 36% were labour force, 50% supervise others and 41% had less than six months on the project. The second survey was undertaken in March 2013, and had 475 respondents: 92% were male, 55% labour force, 45% supervised others and 38% have less than six months on the project. The surveys had a mixture of 5-point Likert scales (strongly agree, agree, neither, disagree, strongly disagree), unbalanced 4-point scales (always, sometimes, rarely, never), 3-point scales Likert scales (high, medium, low) and forced choice 'yes' or 'no' questions. Researchers have attempted to find the number of scale points that maximise reliability but with contradicting results (Chang, 1994). Details on the respondents age, job title, employer, department and if they were a parent were asked in order to scrutinise the results closely for trends in particular groups. The survey covered a wide range of questions including: the respondents experiences since joining the project from an induction and training to witnessing and reporting unsafe acts; whether production pressure influenced safety; whether safety briefings are relevant; whether the respondent would challenge another worker in an unsafe act; whether their boss would understand if the respondent stopped work for safety concerns.

Three different methodological approaches were used to analyse the validity of the survey and the thought consistency questions. The thought consistency questions were identified and the survey results (percentages) compared. This simple quantitative comparative analysis was used on questions which were based on time pressures, money and safety procedures. Two aspects of validity were examined: the content validity (including the face validity) and criterion validity, or more specifically predictive validity. Using five subject-matter experts (SMEs), the content validity was examined using Lawshe's (1975) well-established 'content validity ratio'. The ratio for each item was then compared with Lawshe's critical value for five SMEs. The predictive validity was investigated using the accident and incident figures for the next six months after the second survey. Using these figures, comparisons were made between a department (35% of overall respondents) that the survey had highlighted as an area of concern and all the other departments combined. A functionalist perspective on safety climate was taken, where the safety climate is assumed to being interdependent of the safety performance.

SURVEY ANALYSIS

The following two sections analyse the survey in different ways: the first attempts to investigate thought consistency questions and the second the validity of the survey.

Thought Consistency Questions

The external consultant used thought consistency questions which were similar and not reversed but used a different scale. For example, respondents were asked the following 'yes or no' question: 'Have you worked when you didn't think it was safe to?'. Later in the survey, using a 5-point Likert scale (strongly agree, agree, neither, disagree, strongly disagree), respondents were asked to what extent they agreed that 'I have worked when I thought it wasn't safe to do so'. On the first survey, 8% said 'yes' and 12% 'strongly agreed' or 'agreed'. On the second survey, 12% said 'yes' and 14% 'strongly agreed' or 'agreed'. To compare the two, the percentage difference between 'yes' and the combination of 'strongly agree' and 'agree' was investigated. Since the same respondents are essentially answering very similar questions, the answers would be expected to be the same. Employees have either worked when they thought it was unsafe or they haven't and the same question should yield the same result regardless of the scale. Yet this small but significant difference in percentages show that 'yes' did not equal the sum of 'strongly agree' and 'agree' and that 'no' did not equal the sum of 'disagree' and 'strongly disagree'. When given the middle option of 'neither', there were 10% who took it in the first survey and 18% in the second. This finding indicates that results will differ depending on whether a forced choice scale is used (e.g. yes or no) or a Likert scale with a neutral option is used; yet it is not clear which scaling is more reliable.

The first and second surveys had questions which related to time pressure affecting safety. Though the questions were not the exact same or exact opposites, there was still a strong resemblance. Using a 5-point Likert scale, two questions asked: to what extent do you agree that 'I take shortcuts with safety to get the job done quickly' and 'Safety will not be affected by time pressure on this job'. On average, 50% strongly disagreed that they 'take shortcuts with safety to get the job done', yet only 23.5%, on average, strongly agreed that 'safety would not be affected by time pressure on this job' - a clear inconsistency.

The column chart below (see Figure 1 on the next page) compares two reversed questions used in both surveys: ‘Production pressures get in the way of safety’ and ‘There is not enough time to do my work safely’. The results between the first and second survey are closely related, but the thought consistency is not demonstrated. On average, 71.5% thought that was ‘always’ enough time for them to do their work safely, but only 17.5% thought production pressures ‘never’ got in the way of safety. While these questions are not exact opposites, a closer correlation of results might have been expected. One interesting point to note is that, when the question becomes personal with ‘I’ or ‘My safety’ the results seem to differ e.g. ‘Production pressures get in the way of safety’ and ‘There is not enough time to do *my* work safely’. It could be the case that there are a significant percentage of individuals that think they have time to do their work safely, but are aware of others that don’t.

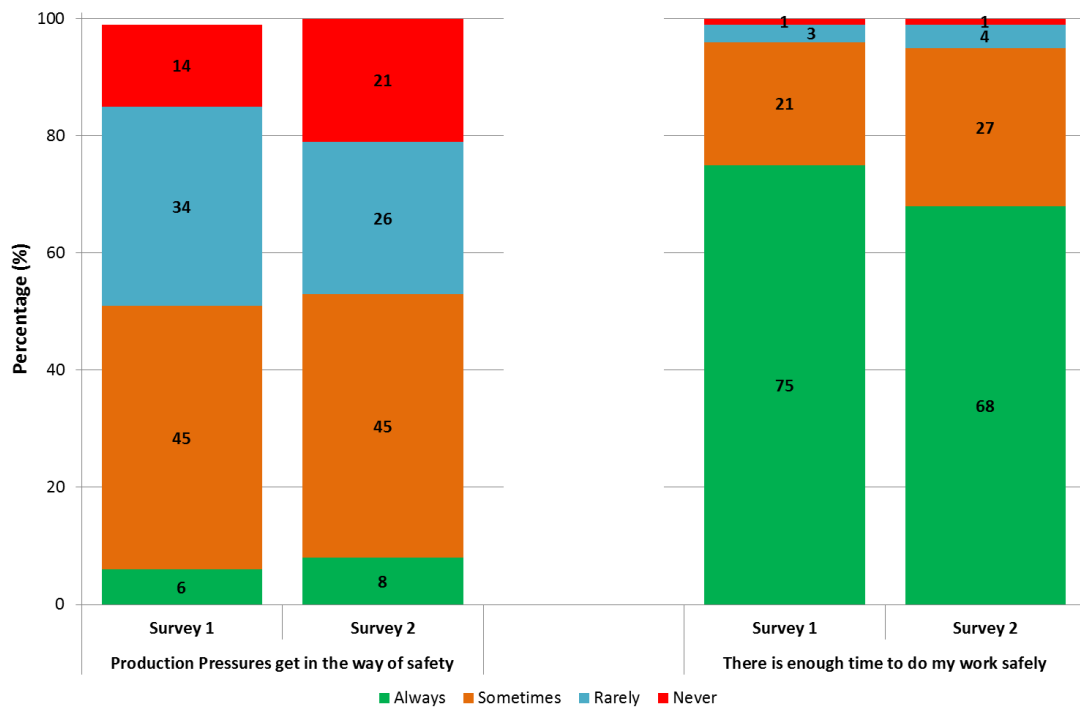

Figure 1- Time pressure thought consistency questions using a 4-point scale

This personal aspect was further investigated and many of the other questions gave the same conclusion: a personalised question gave a different result to a non-personalised question, despite appearing to be very similar or the same question. For example, respondents were asked to what extend do you agree that ‘My safety matters more than money to my employer’ and ‘Safety always comes first, even if it affects profit or production’ (see Figure 2 below), this time using a 5-point Likert scale.

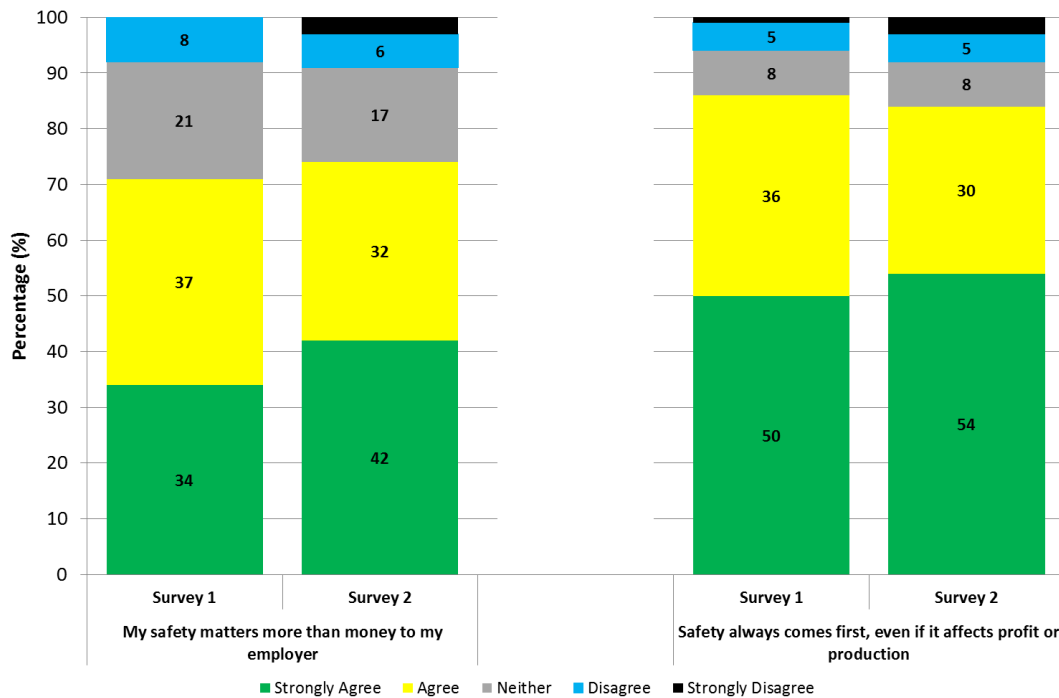

Figure 2 - Money and Safety thought consistency questions using a 5-point scale

When the question became personal the results changed. Fewer respondents ‘strongly agreed’ (38% average) that their safety mattered more than money to their employer, yet over half (52% average) strongly agreed that safety comes first, even if it affects profit or production. The greatest limitation of this comparative analysis is that though these questions are very similar and likely to be interpreted in a comparable manner, they are not exactly the same or exactly opposite. Therefore, some difference is to be expected in these thought consistency questions. However, this difference is unlikely to be of the quantity shown in these results. For example, when 71.5% agreed that there was ‘always’ enough time to do their work safely, it would be expected that a similar figure would agree that production pressures ‘never’ get in the way of safety, but only 17.5% did - a sharp contrast to 71.5%. This suggests that the results still change when the question is personalised.

There was another set of consistency questions worthy of note. In the second survey, 91% of respondents strongly agreed or agreed that ‘they take responsibility for the safety of workmates’. However, when asked if they would challenge a workmate who was: speeding (52% said no), not wearing gloves (50% said no), not clearing up (49% said no), not wearing eye protection (46% said no), using a mobile phone in an unsafe place (45% said no) and the list continued. On a vague question like would they ‘take responsibility for the safety of workmates’, the vast majority agreed (91%) but when asked more specific questions on taking responsibility and challenging their colleagues, this number dropped, in some cases, to around half.

Validity

Content validity is essentially whether the survey assesses the characteristics it was intended to measure. Lawshe (1975) developed a formula that determines the ‘content validity ratio’. The ratio is based on responses from subject-matter experts (SMEs),

whom are required to respond to the following question for each item: is the skill or knowledge measured by this item ‘essential’, ‘useful but not essential’ or ‘not necessary’ to the performance of the construct? Five SMEs within the safety department at the project completed this question for each item. Lawshe’s work states that at least half of the SMEs must deem the item to be ‘essential’ for that item to have at least some content validity. The overall number of items that were identified as ‘essential’ by each SME is tabulated below as a percentage. The ‘useful but not essential’ and ‘not necessary’ items have been grouped together into the ‘not essential’ column to allow for simple comparisons.

Table 1 - Overall number of items deemed essential

SME	Essential (%)	Not Essential (%)
1	75	25
2	87	13
3	53	47
4	50	50
5	61	39

For five SMEs, Lawshe gives a critical value of content validity ratio of 0.99. Hence, for an item to pass this critical value, all five SMEs need to deem the item ‘essential’. 44 of the 128 questions passed this critical value. This analysis was useful for highlighting items that were perhaps not required. A 25-question section in particular had a low content validity ratio, suggesting that it should possibly be completely removed. This section had the question: ‘To what extent do you think you are at risk in your daily work?’. A wide range of various risks then followed including a ‘trip over object’, ‘eye injury’, ‘radiation’ and ‘fatigue’.

Using a face validity approach, it appears that throughout the survey, the appropriate language appears to be used almost all the time. The language used was basic, which is ideally suited for the respondents as there are some that struggle to read and write. It was also translated into foreign languages for those who were non-native English speakers. Having said that, there were areas where the survey could have been improved. Surveys should try and avoid bias, leading, emotional or evocative language. The following question uses a strong negative word: to what extent do you agree that ‘peer pressure sometimes makes me do things I know are wrong’. The word ‘wrong’ should have been avoided, with something like: ‘peer pressure influences me to work unsafely’, being a preferable option. Another question was ‘double-barrelled’: ‘My concerns about safety are listened to and acted on’. This is double-barrelled as it really is asking two questions: ‘are your concerns listened to’ and ‘are they acted on’.

Another example was a question that asked to what extent you agree that ‘I am at risk every day’. Everyone is at some risk every day, so is this question asking whether the risks that the respondents are exposed to are acceptable? The results of this question were not simple to analyse either. More construction employees thought that they were at greater risk than in the previous survey, but is this because the site now has more risks, more labour-force or because workers have improved their risk perception? Another question asked if ‘we could complete this job without a serious accident’. Though this question could also be interpreted differently as what

constitutes a serious accident? Would a broken ankle be determined serious? Such a question is bound to be interpreted differently by respondents and should have been more specific. One of the two subsections of criterion validation is predictive validity - whether the survey can forecast future trends.

The second survey highlighted one large department that had: ‘more unsafe behaviours; lack of adherence to procedures and rules; loss of confidence in safety management and confusion to which rules apply’.

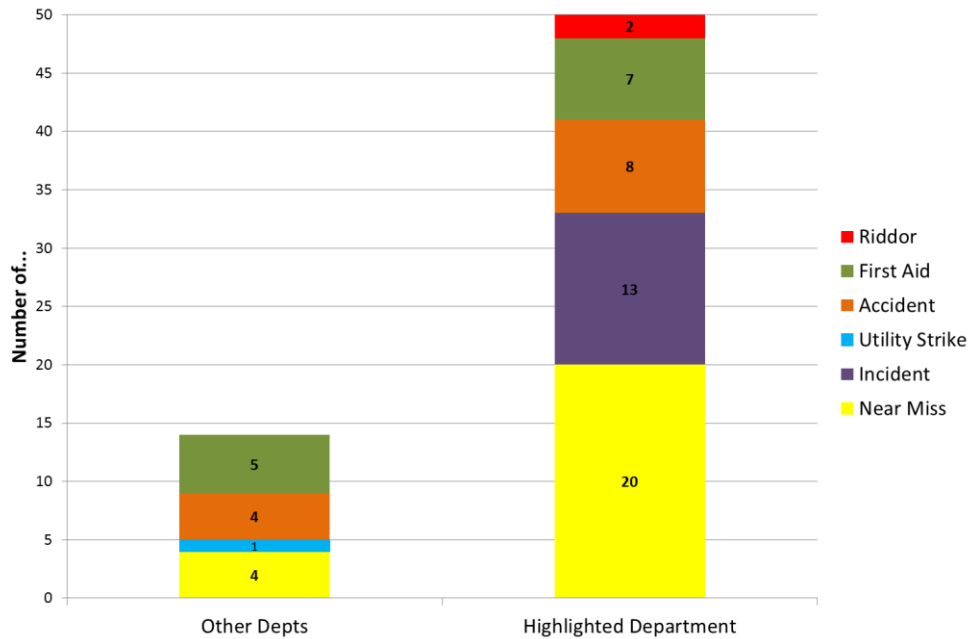

Figure3 - Accident Incident statistics for the six months after the second survey

A separate presentation was given to this department as they had been highlighted as an area of concern. The accident and incident figures for the next 6 months after the survey were compared for this highlighted department against all the other departments combined. The results can be seen in Figure 3 above. The highlighted department was large but still only compromised to 35% of overall respondents. From the respondents who were ‘labourers’: the highlighted department had 104, compared to 157 within the combined other departments. The survey had revealed poorer safety attitudes and more unsafe behaviours in this highlighted department, and therefore on this basis, it would be expected that more incidents and accidents would occur in the highlighted department. Clearly in the 6 month period after the survey was completed, the highlighted department had far more accidents and incidents. This suggests that this survey, to a certain degree, managed to predict future trends. Assuming that the functionalist approach used (i.e. that poorer attitudes and more unsafe behaviours will cause more accidents and incidents) is a sound interpretation, this finding adds weight to evidence that safety climate surveys can forecast future outcomes.

CONCLUSIONS

The aim of this paper was to analyse the ‘thought consistency’ questions and the validity of safety climate surveys using a sample of two from a large UK civil engineering project. The survey results indicated that thought consistency questions appeared to not act as a successful check or trap when a personalised question was compared with an impersonalised. Hence, it is recommended that future surveys should only compare personalised thought consistency questions with other personalised thought consistency questions, and likewise, impersonalised with impersonalised thought consistency questions. Thought consistency questions are an important check but these questions need to be carefully worded to be of use. It is also valuable to use a consistent or comparable scale for analysis. In this survey, there were cases where four or five consistency questions were used, but with different scales, which made direct comparisons impossible.

Although the majority of questions showed at least some content validity, only 44 of the 128 questions passed the Lawshe’s critical value for content validity. Lawshe’s content validity ratio is not only useful for measuring content validity but it identified items which scored poorly and hence could be deemed not necessary. It is recommended that the creation of safety climate surveys should involve this check to identify questions that are potentially not required, since such questions could be adding unnecessary length and diluting the results. The survey highlighted a particular department (35% of respondents) as an area for concern. In the following six month period this department had far more accidents and incidents than the rest of the departments combined, suggesting that safety climate surveys can, to some degree, predict future trends.

REFERENCES

- Budworth, T. (1997), The development and evaluation of a safety climate measure as a diagnostic tool in safety management. *Journal of the Institution of Occupational Health and Safety* 1, 19-29.
- Carroll, J., (1998). Safety culture as an ongoing process: culture surveys as opportunities for enquiry and change. *Work and Stress* 12, 272±284
- Chang (1994) A Psychometric Evaluation of 4-Point and 6-Point Likert-Type Scales in Relation to Reliability and Validity
- Cheyne, A., Tomas, J., Cox, S., Oliver, A. (1999). Modelling employee attitudes to safety: A comparison across sectors *European Psychologist*, Volume 4(1), 1-10.
- Coyle, I., Sleeman, S., Adams, N. (1995), Safety Climate, *Journal of Safety Research*, Volume 26, Issue 4, 247-254
- Dedobbeleer and Beland (1991). A safety climate measure for construction sites. *Journal of safety research*, 26, 247-254.
- Donald, I., Canter, D., (1994) Employee attitudes and safety in the chemical industry. *Journal of Loss Prevention in the Process Industries* 7, 203±208.
- Downes-Le Guin, T., Baker, R., Mechling, J., Ruylea, E. (2012). Myths and realities of respondent engagement in online surveys, *International Journal of Market Research* Vol. 54 Issue 5
- Fink, A (2002). *The Survey Handbook*, Sage publications

- Fleming, M., Flin, R., Mearns, K., Gordon, R., (1998) Risk Perceptions of Offshore Workers on UK Oil and Gas Platforms, *Risk Analysis*, Volume 18, Issue 1, pages 103-110
- Flin, R., Mearns, K., O'Connor, P., Bryden, R. (2000) Measuring safety climate: Identifying common features, *safety science* 34 177-192
- Grubb, P. L., and Swanson, N. G. (1999) "Identification of work organization risk factors in construction." *Proc.*, 2nd Int. Conf. of Int.
- Glendon & Staunton (2000) Perspectives on Safety Culture, *Safety Science*, 34, 193-214, Council for Research and Innovation in Building and Construction
- Guldenmund, FW. (2000). The nature of safety culture: A review of theory and research. *Safety Science*, Vol.34, No1-3, pp215-257.
- Hopkins, A (2006). Studying organisational cultures and their effects on safety, *Safety Science* 44 875-889
- Hale, A (2000), Culture's confusions, *Safety Science*, 34, 1-14
- HSC (Health and Safety Commission), (1993). Third report: organizing for safety. ACSNI Study Group on Human Factors. HMSO, London.
- HSE, (2003) Causal Factors in construction accidents, Research Report 156, prepared by Loughborough University and UMIST for the HSE
- Lawshe, C (1975). A quantitative approach to content validity. *Personnel Psychology*, 28, 563-575.
- Mohamed, S (2002) Safety Climate in Construction Site Environments, *Journal of Construction Engineering Management*, 128(5), 375-384
- Pidgeon, N. (1991). Safety culture and risk management in organisations. *Journal of Cross-Cultural Psychology*, 22, 129-140
- Schein, Edgar (2004) *Organisational culture and leadership*, 3rd Edition, Jossey Bass
- Turner and Pidgeon (1997), *Man-made disasters* (Oxford, Butterworth-Heinemann)
- Wamuziri, S. (2013), Factors that influence safety in construction, *Management, Procurement*, Vol 166: 219-231
- Whittingham, R. (2012) *Preventing Corporate Accidents*, Routledge
- Zohar, D. (1980). Promoting increased use of ear protectors in noise through information feedback. *Human Factors*, 22(1), 69-79

SCREENING FOR FATIGUE-RELATED IMPAIRMENT IN THE WORKPLACE

Ronald Powell¹ and Alex Copping²

¹*Pro Trans BC, Vancouver, Canada*

³⁶*Department of Architecture and Civil Engineering, University of Bath, Bath, UK*

Fatigue-related cognitive impairments may affect operational capacity. Simple cognitive screening techniques for alertness might help detect such impairments objectively. Results from previous studies on the effects of fatigue-related impairment have shown decrements in cognitive capabilities in memory, learning, selective attention, task accuracy and reaction times. The effects of sleep debt, the circadian cycle and the influence of caffeine consumption have not been widely studied despite their importance for alertness in operational settings. The current study investigated the sensitivity of a brief, practical and repeatable computerized cognitive screen to changes in the circadian rhythm in a 24 hour operational setting. Potential confounding factors affecting alertness were also measured, including hours of sleep and caffeine consumption. It was found that alertness level changes due to the circadian rhythm were detectable and that reaction-time tests were most sensitive to changes in alertness levels. These measures remained robust to fatigue-related impairment when the additional confounding factors were considered. Specific subtests, measuring simple and choice reaction time, appeared the most likely candidate tasks for a brief screening test for performance deficits.

Keywords: alertness, circadian, cognitive screens, fatigue, impairment.

INTRODUCTION

Recent studies have confirmed suspected broad fatigue-related impairment in the hazardous operating environment of construction (Powell 2009 Powell and Copping 2010). Fatigue has been linked as a causal or contributing factor in many industrial and non-industrial accidents due to effects on judgment, decision making and reaction times. With the improvement in the management of illicit drug and alcohol-related impairment in the workplace (Powell 2010), increased understanding of the specific impairment effects of inadequate sleep is required especially in hazardous environments where the risk from any impairment increases. In addition to awareness of the higher risk of accidents and lost productivity, practical and objective tools to identify and quantify fatigue-related impairment and consequent cognitive changes in an operational setting are needed.

While fatigue-impaired performance is not a new issue, it has not been addressed in many industries. Dinges followed aircraft crews in trans-meridian flights to better understand the impact of circadian shifts and long duty hours on alertness levels (Dinges et al. 1996) and Russo evaluated cognitive performance, judgment, and decision-making (CPJD) in military personnel to predict cognitive performance, and

develop countermeasures and means to sustain performance despite sleep-deprivation (Russo et al. 2005).

Several research projects have been conducted to better understand the effects of sleep deprivation on cognitive performance in general but are more limited in specific jobs. Lim and Dinges (Lim and Dinges 2010) have summarized the research in this area, reporting effects on speed and accuracy in six different cognitive domains including simple and complex attention, working memory, processing speed, short-term memory, and reasoning.

In this study, we aimed to measure changes in alertness due to natural circadian oscillation. We chose to evaluate simple brief computerized cognitive tests because they might be candidates for detection of fatigue-related impairment in screening programs in relatively uncontrolled operational settings. The current study aimed first to evaluate the feasibility of serial computerized cognitive measurement in a busy operational environment using one validated instrument. The second aim was to determine whether the cognitive performance in domains previously reported as related to fatigue (Falletti et al. 2003) correlated with established circadian cycles since this would suggest such measurements are robust enough to provide estimates of alertness despite real world confounding factors. The hypotheses of this study were that (i) a brief computerized cognitive test could be utilized in a real world workplace to produce surrogate test markers of alertness assessing processing speed, attention and working memory, and (ii) variations correlated with circadian rhythms. We used linear mixed effects models, which acknowledge the possible dependence in measurements recorded from the same individual, to assess the relationship between known pre-specified individual factors related to alertness to allow them to be used for further comparisons to known effective models of fatigue (Van Dongen 2004). Additionally, linear mixed effects modeling allows understanding of the magnitude and real world significance of measured confounders on the results.

METHODOLOGY

The study was conducted from May to December 2010 at a fully automated (driverless) commuter rail operation in metropolitan Vancouver, Canada. All operations and construction maintenance are handled out of a centralized facility operated around the clock, 365 days per year as a public-private partnership. Workers involved in movement of rail-borne equipment are classified as safety critical roles by Canada's Railway Safety Act making fatigue management extremely important.

From a pool of over 200 employees, 24 workers volunteered to participate with each having different shift patterns that allowed testing comparisons at different times of the circadian cycle. Employees were all full time workers who had to fit the tests in during their regular work duties. Employees understood they needed to perform two tests per day to provide comparable results for that day. With permission from the employer, workers participated purely out of personal interest, with no additional incentives or remuneration. No selection or exclusion was made on factors that may be related to alertness, such as smoking, drinking, sleeping, exercise and caffeine consumption. The study was in part attempting to model results, understand failure modes and sensitivities of this technology for detecting fatigue-impairment in a normal operational setting masked by other factors.

The computerized cognitive tasks chosen (CogState Ltd, Melbourne, Australia) consisted of 5 cognitive tests that require 10-12 minutes to complete. Tasks use a game-like format to assess the cognitive domains of psychomotor processing, visual attention, learning and working memory.

The tasks were presented in the following order:

1. Detection (DET) is a simple reaction time task which requires a “Yes” response as soon as the central card turns face up. Anticipations are defined as a response earlier than 100 milli-seconds (ms) after the card turns face-up, and lead to re-scheduling of another trial. The task terminates after 35 correct responses. Task duration is approximately 100 seconds.

Identification (IDN) is a choice reaction time task which requires a “Yes” response if the face-up card is red, and a “No” response if it is black. The task terminates after 30 correct responses. Task duration is approximately 100 seconds.

The One Card Learning (OCL) test is a test of visual learning, which requires a “Yes” response if the face-up card has been seen before in the same task, and a “No” response if it has not been seen previously. There are 42 presentations, with 6 repeating cards of different suits and denominations, and additional randomly chosen cards repeating as well. Total task duration is approximately 3-4 minutes.

The One Back (ONB) test is a test of working memory, requiring a “Yes” response if the face-up card is exactly the same as the previously presented card, and “No” response if it is not the same. The task terminates after 30 correct responses. Task duration is approximately 90 seconds.

The Two-Back (TWB) test is also a test of working memory, similar to the ONB but in which a “Yes” response is required if the face-up card is exactly the same as the card two presentations back, and otherwise requires a “No” response. The task terminates after 30 correct responses. Task duration is approximately 110 seconds. Each participant had either an assigned personal computer or had access to one in the normal course of their work to access the testing applications. All testing was conducted on sessions hosted by CogState with encrypted data uploaded directly to their database for extraction and analysis.

Four nodes were established for testing associated with an expected natural circadian cycle shown in Figure 1. Node 1 was taken as 03:00 to 06:00; Node 2 was 08:00 to 11:00; Node 3 was taken as 13:00 to 16:00; and Node 4 was taken as 18:00 to 21:00. Participants all had shifts which crossed at least two nodes. The established node times were somewhat broad to allow for the practicalities of work shifts but participants were to select common times for testing within each node and test results were accepted from sessions conducted within these nodes and a work shift within a 24-hour period with repeat start times set ± 30 minutes.

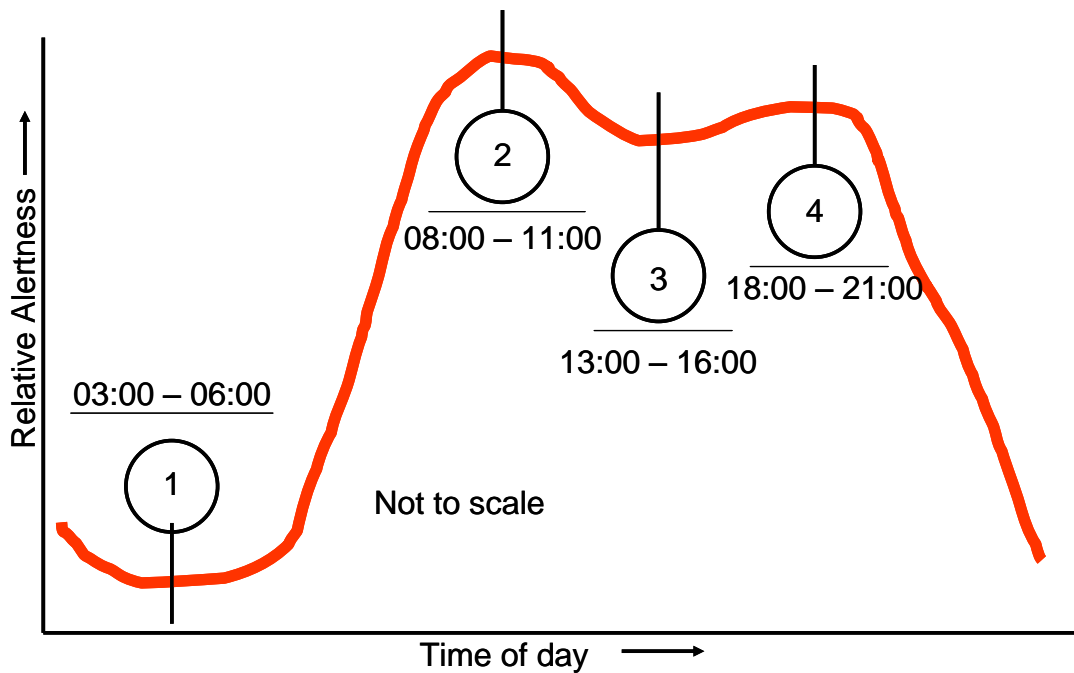

Figure 1 – Nodes used from the Circadian Cycle (not to scale).

RESULTS

Of the 24 employees who volunteered to participate, 11 were unable to provide any usable data post training because they were unable to commit to doing 2 rounds of testing a day in conjunction with their work responsibilities. Of the 24, 8 males and 5 females aged between 29 and 56 years (mean age 41.5 ± 9.5 years) provided valid test results. There were 9 of these who were shift workers. In aggregate they contributed over 150 work hours testing in this study. All but one of the participants regularly consumed a beverage with caffeine in it. Participants' results were monitored daily and demonstrated they had quickly become familiar with the process and interaction with each task. There were 364 valid tests completed. The average number of tests completed by each participant was 26 (range 2 to 100, Q1 8, median 20, Q3 30). There were an additional 83 test sessions conducted during a shift without a second test session for comparative results rendering these 83 sessions unusable. Only 7 tests from 2 employees failed integrity checks. Participants' reasons for these failures were predominantly distractions caused by their assigned duties interfering during test taking. Aside from these few explanatory comments, day and shift schedule, participants provided little additional information in feedback comments and none that could be considered adequate for inclusion in the analyses.

Of the four possible points assigned for testing, all provided some test results between nodes 2 and 3; 1 participant provided test results between nodes 3 and 4; 2 tested between nodes 1 and 2 and 4 participants conducted tests across nodes 4 and 1.

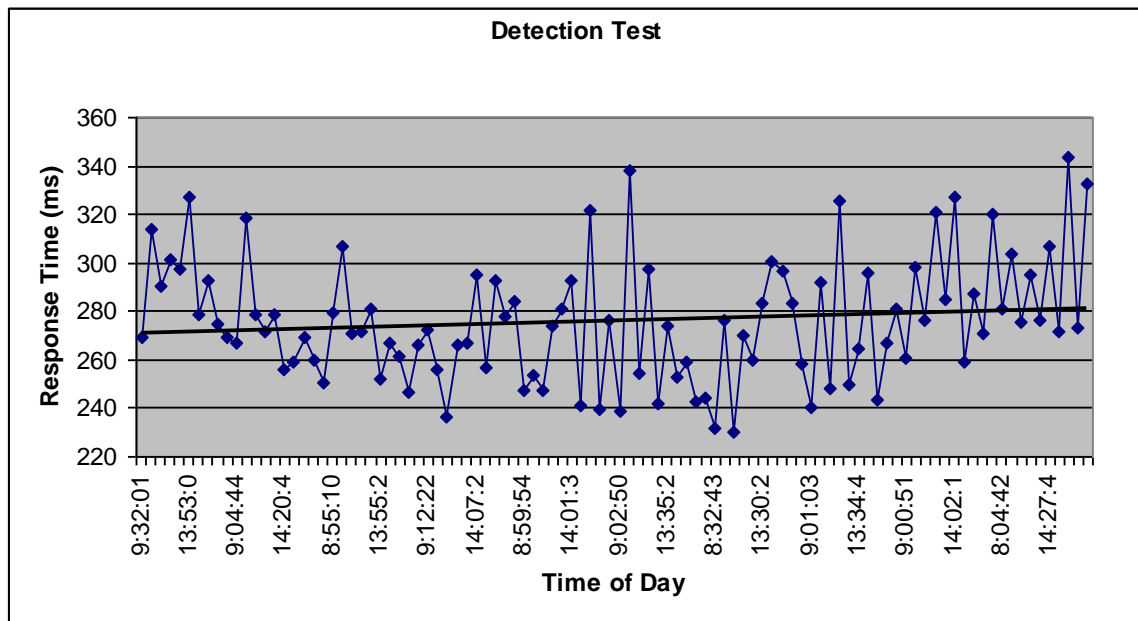

Figure 2 – Detection Test Results for Participant ‘A’

Figure 2 is an example of one set of results for the DET task from one participant showing the variability in mean reaction time over 65 days (100 tests). It can be seen that mean reaction time varies between 230 and 344 ms and there are diurnal variations with slower reaction times usually in the afternoon. A trend line indicates that over the course of the testing, average response increased slightly from 269 ms to 280 ms. Valid data from each individual was paired for each of their shift tests and was plotted and trended to understand individual performance of each task over time.

Table 1 – Results from analysis of variance comparing the effects of node and other variables on each of the five outcomes.

Outcome	Model	Log-likelihood	Chisq	df	p-value
DET	Subject level random effect	-1737.5			
	Effect of node	-1732.8	9.445	3	0.024
	Additional effect of hours awake, hours sleep and caffeine intake	-1611.8	241.974	3	<0.001
IDN	Subject level random effect	-1789.1			
	Effect of node	-1784.9	8.474	3	0.0372
	Additional effect of hours awake, hours sleep and caffeine intake	-1647.1	275.636	3	<0.001
OCL	Subject level random effect	-2026.1			
	Effect of node	-2025.1	2.060	3	0.560
	Additional effect of hours awake, hours sleep and caffeine intake	-1872.6	305.078	3	<0.001
ONB	Subject level random effect	-1878.5			
	Effect of node	-1875.1	6.8038	3	0.078

	Additional effect of hours awake, hours sleep and caffeine intake	-1733.6	282.9483	3	<0.001
TWB	Subject level random effect	-1761.2			
	Effect of node	-1759.3	3.8791	3	0.275
	Additional effect of hours awake, hours sleep and caffeine intake	-1618	282.631	3	<0.001

The effects of node on the outcomes of the five tasks are shown in Table 1. For each outcome, a series of models of increasing complexity are compared using analysis of variance in order to assess the significance of terms in the models. The series of models is as follows; (i) a baseline model which has a random intercept term for each subject, (ii) the addition of the effect of node and (iii) the additional effects of caffeine, hours awake and hours sleep. The latter model is included as part of the aim of this study was to understand whether common workplace factors known to affect alertness would relate to the CogState test results and to assess how they might affect the effectiveness of the tests in an operational setting.

Significant effects of node are found for DET and IDN. In addition, the effects of the other alertness related variables were found to be highly significant after allowing for node for all tests.

DISCUSSION

This is the first study to evaluate brief serial computerized cognitive testing in a busy uncontrolled real world workplace environment. Both in terms of statistical significance in relation to the association with nodes and in the patterns observed over the circadian cycle, considering magnitude and uncertainty, these results show that these cognitive screening tests could detect changes in alertness as small as that associated with natural fluctuations in the circadian cycle. This was without control of masking agents. The hypothesis that a brief computerized cognitive test could be utilized in a real world workplace to produce surrogate test markers of alertness assessing processing speed, attention and working memory and show variations correlating with circadian rhythms was supported. Of the potential test markers, reaction time surfaced as the dominant surrogate marker.

The tasks most reliant on reaction time therefore gave stronger results of correlation with circadian alertness changes. The association was seen in speed (reaction time) measures for Detection (DET) and Identification (IDN) most clearly. We found that estimated response times and measures of variability obtained from the linear mixed effect model for the DET task appeared to be very well aligned with the alertness levels of the circadian cycle. These results support expectations that when the participants were meant to be most alert their results were optimal and varied least. When they were at their lowest levels of alertness, performance was worst and most variable suggesting the cognitive task results were able to detect changes in alertness. These findings are consistent with the report of Falleti (Falleti et al. 2003) in which fatigue-related impairment was associated with a larger deterioration on the DET speed responses than on any other performance measure.

We verified that as identified by others, (Van Dongen 2004), caffeine, hours awake and hours of sleep can have a significant effect on test performance suggesting that in

all future work in operational settings with cognitive tests, these factors must be considered.

The first aim was to evaluate the feasibility of serial computerized cognitive measurement in a busy operational environment. The simplicity and brevity of the tests allowed the vast majority of participants to repeat the tests within their normal working hours multiple times demonstrating familiarity and understanding of the testing requirements. Only 7 of 447 completed tests (1.6%) failed the relatively simple integrity criteria. Furthermore, most (11/13, 85%) of the participants passed all integrity criteria in every test they did. The two participants who failed integrity checks did so simply because their work responsibilities interfered with their concentration during the test. This was not an unexpected limitation of conducting this study in a real workplace rather than a laboratory setting and the fact that participants required about 30 minutes per pair of tests to be blocked out from work distractions. Tied to this work factor there were an additional 11 participants (46% of initial volunteers) who failed to provide usable data despite training and expressing initial interest. Their work schedules did not allow testing at the defined times twice a day for this length of time. All evidence suggests there were no issues using or understanding the tasks and had the test been a single cognitive task instead of the battery of 5 tasks, compliance may have improved to provide more successfully paired tests from more participants. In addition, the modeling analysis showed no systematic evidence of improvement with repeated testing. Hence, there appears to be preliminary support for stable results with minimal practice effects in a busy work place as has been reported under more controlled experimental conditions with serial testing (Falleti et al 2006). These observations therefore support the feasibility of evaluating this type of computerized cognitive testing further in a work environment. When considering possible tests to detect fatigue-related impairment in an operational setting, simplicity of test-taking and robustness of results are key factors. Simplicity of a test and the total time to complete tests carries significant weighting for selection. The length of testing during this study supported prior experience that long testing sessions affect completion rates and reduce their suitability as workplace testing programs. Individually all the tasks partially met this requirement (i.e. all took less than 4 minutes to complete). The validity of measurement and robustness of inference from the results are the key determinants of candidate tests. Based on the analyses presented here, the DET and IDN tasks appear the most promising. Both are brief tests and both rely on reaction time as the primary outcome measure of the test. OCL would be the next choice based on demonstrated alignment to the circadian; however, it is a longer test to conduct. Future studies could therefore evaluate whether using a briefer battery containing only DET, IDN and/or OCL tasks might further improve acceptability.

CONCLUSIONS AND LIMITATIONS

This study attempted to determine if selected cognitive tests carried enough sensitivity to changes in alertness to show a difference that correlated with natural changes in the circadian cycle without being confounded by other factors. The study results support sensitivity of cognitive task measures to circadian influences on alertness and suggest they are possible surrogate candidate markers to screen for fatigue-related impairment. Values for response speeds varied on average 3.4% between nodes (e.g. 2-3; 10 ms slower) suggesting a range of sensitivity for future studies to account for circadian

influence and verifies the circadian influence should be accounted for when using these tools.

A strength of this study was that it was undertaken in a real workplace environment, in which workers were undertaking their usual work responsibilities. Over the course of their shifts we were able to track the variability in their presumed alertness. The results suggest that significant variation in cognitive performance occurs over the course of the day making circadian variations an important factor to consider when evaluating fatigue-related impairment. A limitation of this study was the small sample size, which may have incorrectly estimated the impact of other specific factors influencing results. Indeed, larger numbers of subjects would be expected to clarify the contribution of specific individual factors that affected the range of differences in responses of participants. In a real work environment, additional factors can be obtained over time but due to the sensitive nature of collecting personal information from workers, extracting this data may always be a challenge.

With these limitations and based on this study's results, some features of ideal cognitive tasks that are likely to correlate with alertness can be described. Tasks that have minimal practice effects, are brief and utilize reaction time measures are expected to show impairment early. Hence, future research should include reaction time measures in potential workplace fatigue assessment programs particularly in safety critical activities. If future research confirms these findings, then situational awareness education should also include information on alertness variation correlations with circadian cycles, and emphasize periods when alertness is likely to be suboptimal. Whether measurement of actual alertness using surrogate cognitive measures like those used in this study will occur depends on the replication of the current results in future research.

REFERENCES

- Dinges, D. F., Graeber, R. C., Rosekind, M. R., Samel, A. & Wegmann, H. M. 1996. Principles and Guidelines for Duty and Rest Scheduling in Commercial Aviation. In: NASA (ed.) NASA Technical Memorandum 110404 ed.
- Falletti, M. G., Maruff, P., Collie, A., Darby, D. G. & McStephen, M. 2003. Qualitative similarities in cognitive impairment associated with 24 h of sustained wakefulness and a blood alcohol concentration of 0.05%. 'Journal of Sleep Research', 12, 265-274.
- Falletti, M. G., Maruff, P., Collie, A. & Darby, D. 2006. Practice effects associated with the repeated assessment of cognitive function using the CogState battery at 10-minute, one week and one month test-retest intervals. 'J Clin Exp Neuropsychol', 28, 1095-1112.
- Lim, J. & Dinges, D. F. 2010. A meta-analysis of the impact of short-term sleep deprivation on cognitive variables. 'Psychological Bulletin', 136(3), 375-389.
- Powell, R. 2009. Fatigue-Impairment in British Columbia's Construction Industry. 'Proceedings of the 27th International System Safety Conference', 3-7 August 2009, Huntsville, Alabama. Huntsville, Alabama: International System Safety Society.
- Powell, R. 2010. Impairment in the WorkplaceFatigue Gets a "Free" Pass. 'Proceedings of the 28th International System Safety Society-Building Bridges to a Safer Future', 30 August - 3 September 2010, Minneapolis, Minnesota. Minneapolis: International System Safety Society.

- Powell, R. & Copping, A. G. A. 2010. Sleep Deprivation and Its Consequences in Construction Workers. 'Journal of Construction Engineering and Management', 136, 1086-1092.
- Russo, M., Fiedler, E., Thomas, M., McGhee, J. 2005. 'Cognitive Performance in Operational Environments'. Neuilly-sur-Seine: NATO, (RTO-MP-HFM-124).
- Van Dongen, H. P. A. 2004. Comparison of Mathematical Model Predictions to Experimental Data of Fatigue and Performance. 'Aviation, Space and Environmental Medicine', 75, A15 - 36.

SAFETY ON CONSTRUCTION SITES IN AREAS SUBJECTED TO SEISMIC RISK

Renato G. Laganà¹

³⁷ *Renato G. Laganà 1 Dept. DArTe, Università degli Studi Mediterranea in Reggio Calabria, Via
Melissari Feo di Vito 89124 Reggio Calabria, Italy*

In recent years the frequency of strong earthquakes, in addition to the effects and harmful consequences recorded, did provide research insights that address the component of seismic risk in construction sites. Over the years, the Strait of Messina in southern Italy has experienced, several notable seismic events. The Mediterranean University of Reggio Calabria, has several oriented research projects related to structural problems, modality and the detection of damage assessment for buildings, rendering the prior planning interventions, emergency planning.

The census of the damage carried out on construction sites, in connection with recent seismic events that have affected Italy, has made it possible to obtain a number of indications that have partially confirmed the importance of considering seismic risk in risk analyses. The analyses undertaken have identified several situations in which the collapse or damage to structural elements or temporary works can cause economic damage as well as physical injury or loss of life. The seismic component must lead to the implementation of the series of damage in the identification of many types of risk. The solution must therefore be approached on the one hand a social perspective, tending to regulate the presence of workers in the zones that could collapse, and on the other to a technical design approach aimed at avoiding the collapse of equipment, temporary works and structures. The various field techniques, belong to substantially different disciplines: the first is prevention, i.e. the reduction of the likelihood by limiting human presence at risk; the second is security, i.e. the reduction of magnitude which the structural element or provisional collapses following a seismic event. If it appears difficult to get a preview of the seismic event (science has not yet reached high levels of forecast) efforts should be focused on effective reporting the state of alert and consequent activation of emergency procedures.

Keywords: earthquake, emergency measures, risk analysis, safety and health management.

INTRODUCTION

In many regions risk analysis for construction site also includes seismic risk. We notice that during the activities of construction, consolidation or demolition of already existing structures, seismic events might create some conditions, which jeopardize workers' health and safety. On August 22 2011 I was attending the CIB Conference in Washington. I noticed that following the earthquake that day there was a stampede to get out of construction sites.

³⁷ rlagana@unirc.it

On March 31, 2002 in Taipei two cranes used in the construction of a skyscraper collapsed because of a 6.8 magnitude earthquake, killing two workers and three pedestrians. There's a video showing the fall and the panic on the street.

Many studies deal with safety in seismic areas, with the structural problems and the phenomena related to natural events. In the past, within the framework of the CIB Task Group 32 (Public Perception of Safety and Risks in Civil Engineering) the paper submitted at IABSE Conference - CIB (Malta 2001) included earthquakes among natural disasters. The topic of seismic risk in building sites has been poorly addressed and requires special attention in geographic areas where earthquakes are very frequent.



Fig 1 - Tower cranes collapse because of an earthquake in Taipei (2002) and an image of earthquake in Washington DC (2011).

SEISMIC RISK

The seismic risk measures the damages expected in a given period of time, depending on the kind of seismic activity, the strength of structures and the level of anthropization. It is calculated on a combination of three elements:

- hazard, which results from the physical features of an area;
- vulnerability, i.e. the predisposition of a structure to be damaged; and
- exposure, which is the chance of incurring an economic damage to structures or losing human lives.

Regarding hazard, thanks to in-depth geological studies we can design technical thematic maps, which enable to determine the level of hazard in a specific area. As for

vulnerability, the development of calculation methods together with analysis carried out in the affected areas allow a better approach to aseismic design and earthquake-resistant buildings as well as the development of systems for structural reinforcement for historical buildings.

The solutions introduced to minimize vulnerability allow a reduction in the exposure of structures and determine smaller damages. Then we must take into account casualties related to the poor resistance of structures and to the way people behave when in panic. In fact, people die not only because buildings and bridges collapse but also because of other phenomena triggered by the seismic event, such as landslides, soil liquefaction, tsunamis or fires. Some statistics on major earthquakes worldwide show that about 25% of deaths on the occasion of an earthquake are due to non-structural damages in buildings: the fall of partitions of windows, cornices, roof tiles, etc.

To assess the seismic risk, seen as a generic risk, we must consider that it is defined by the following expression:

$$R = RSH * LSH * Vu * Exp$$

where:

RSH = Regional seismic hazard, intended as the probability that within a certain period there'll be an earthquake of a certain intensity (seismic macro-zoning);

LSH = Local seismic hazard, which is linked to the geological features of the site (seismic micro-zoning);

Vu = Vulnerability of people, buildings, infrastructures, which are susceptible of damages in case of a seismic event or better their capability to withstand it;

Exp = Exposure, which is the number of units of each of the elements at risk present in a given area, such as human lives or settlements.

To determine the effects of an earthquake we must take into account:

$$RSH * Vu * Exp$$

Which expresses the severity of the consequences of the earthquake, based on geostructural (*RSH* and *Vu*) and socio-economic (*Exp*) surveys at a local level, i.e. magnitude.

Aiming at risk minimization, we can act only on the said factors. In order to avoid the presence of people on the site of the disaster, we should:

predict the seismic event;
issue the alarm; and
enable emergency measures.

Although possible, earthquake prediction is not yet completely meaningful since it is subject to strong approximation. Giving only a few hours (or even shorter) warning does not allow to enable the proper emergency measures. The emergency measures aiming at minimizing the damages need preventative action, i.e. *Seismic design of structural and non-structural elements*. If seismic vulnerability is the susceptibility of a structure to be damaged, in order to reduce the human toll on the occasion of an earthquake of a given intensity we must secure all building structures. Nowadays, provisions set forth for earthquake-resistant design and construction enable buildings

to resist the effects of minor seismic motions, allow a structural damage in case of moderate earthquakes and not to collapse in case of severe earthquakes, although they might be damaged seriously.

We must involve people and raise awareness by training them on emergency measures and on evacuation methods - *an awareness-raising campaign targeting seismic risk education*

THE ITALIAN SITUATION

As for the said parameters, the Italian experience includes:

- a medium-high seismic hazard, given the frequency and intensity of phenomena,
- a very high vulnerability, since building stock, infrastructures and manufacturing system are very fragile; and,
- a very high exposure determined by the residential density and the presence of a historical, artistic and monumental heritage unique in the world.

Italy is one of the most earthquake-prone countries in the Mediterranean area, because of its geographical location, in the area of convergence between the African and Eurasian tectonic plates. It has therefore a high seismic risk, in terms of casualties, damage to buildings, direct and/or indirect costs expected in the aftermath of an earthquake. The damages and the effects of the earthquakes that have marked Italian history of Italian over little more than a century:

- 1908, MESSINA-REGGIO, December 28; magnitude 7.2; 86.000 victims
- 1915, AVEZZANO, January 13; magnitude 6.8; 33.000 victims
- 1919, MUGELLO (Tuscany), June 29; magnitude 6.2; 100 victims
- 1920, GARFAGNANA (Tuscany), September 7; magnitude 6.48; 171 victims
- 1968, BELICE (Sicily), January 15; magnitude 6.4; 236 victims
- 1976, FRIULI, May 6; magnitude 6.2; 976 victims
- 1980, IRPINIA-BASILICATA, November 23; magnitude 6.8; 2570 victims
- 1990, SOUTH-EASTERN SICILY, December 13; magnitude 5.7; 19 victims
- 1997, UMBRIA-MARCHE, September 26; magnitude 5.6; 11 victims
- 2002, MOLISE (S. Giuliano di Puglia), October 31; magnitude 5.6; 28 victims
- 2009, L'AQUILA (Abruzzo), April 6; magnitude 5.8; 300 victims
- 2012, EMILIA-ROMAGNA, May 20/29; magnitude 5.9; 22 victims

The highest seismicity is found in the central or southern part of the Italian peninsula alongside the Apennines: this area was affected by some of the strongest and most destructive events in history.

In Calabria and Sicily, the consequences of seismic events like those occurred in 1783, 1693 and December 28, 1908 had great social, economic and historical repercussions on those areas.

The history of seismic building codes starts with RD 1909/193, which introduced the concept of "choice of building sites" for the areas already affected by seismic events. In 1917 and 1927 were issued other regulations on the delimitation of areas at seismic risk. In 1935 RD 640 set the "Technical standards for construction with special provisions for areas struck by earthquakes." These criteria, to be adopted in order to build a structure while minimizing its tendency to be damaged by a seismic event,

became the basis for effective prevention. Buildings should be able to withstand moderate earthquakes without serious damages and or even without collapsing on the occasion of the most severe events, thus protecting human lives.

The Framework Law n. 64 of 02.02.1974 "Provisions for buildings with special requirements for seismic zones" set the principle of earthquake-resistant buildings while defining their features and new calculation methods. It also set specific provisions for the already existing buildings.

In line with the most modern international standards, the current Technical Standards for Construction (Ministerial Decree, January 14, 2008) changed the role of seismic classification in planning. These standards took effect from July 1, 2009; since then each building must be designed taking into account its own peak ground acceleration identified by means of the geographical coordinates of the project area and depending on the nominal design life of the building.

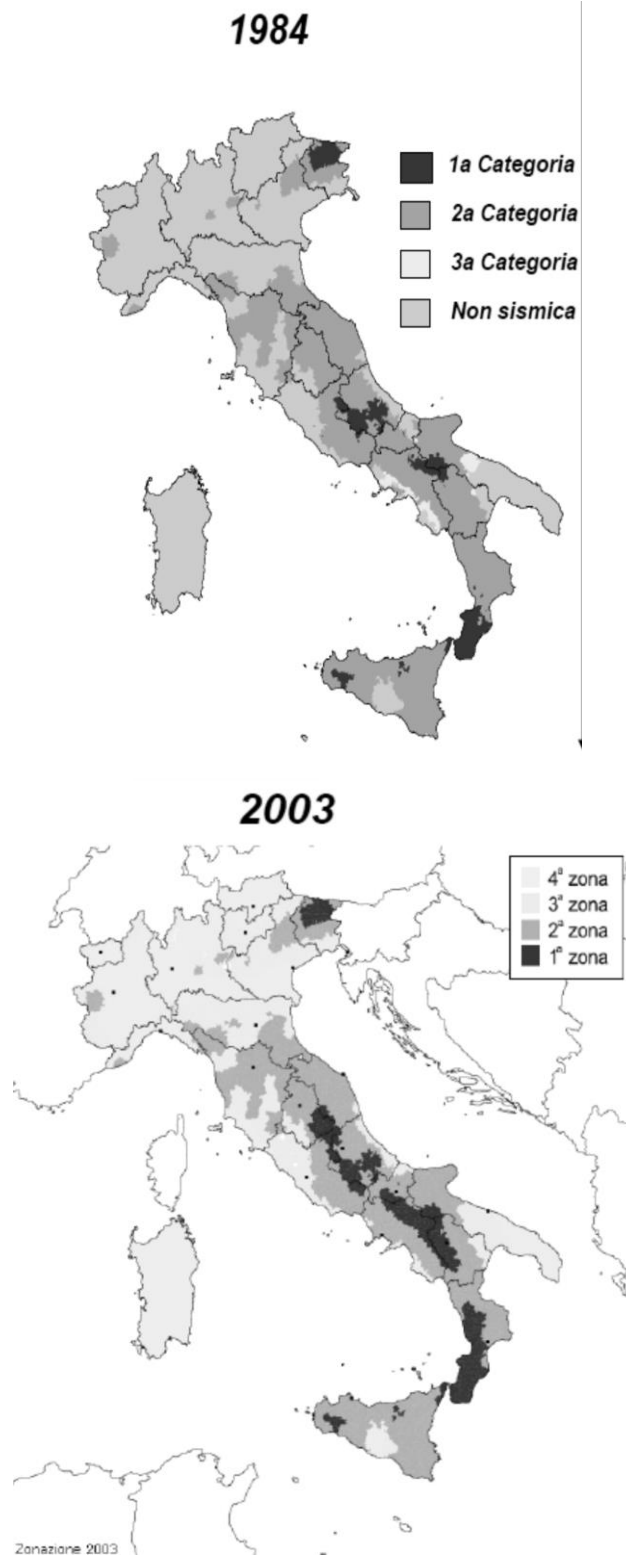

Fig 2 - Extension and classification of the Italian territory in earthquake-prone areas

Table 1 - *Subdivision of seismic zones according to peak ground acceleration.* (OPCM 3519/06)

Zone		Acceleration with a 10% probability of exceeding in 50 years
Zone 1	The most dangerous area. Very strong earthquakes might occur.	$ag > 0.25$
Zona 2	In this area there might be strong earthquakes.	$0.15 < ag \leq 0.25$
Zona 3	In this area there might seldom be strong earthquakes.	$0.05 < ag \leq 0.15$
Zona 4	The less dangerous area: earthquakes are rare.	$ag \leq 0.05$

In zone 4 it is up to the Regional governments to place obligations concerning seismic design. Each zone is associated with a level of earthquake severity, expressed in PGA, which is a useful parameter for seismic design.

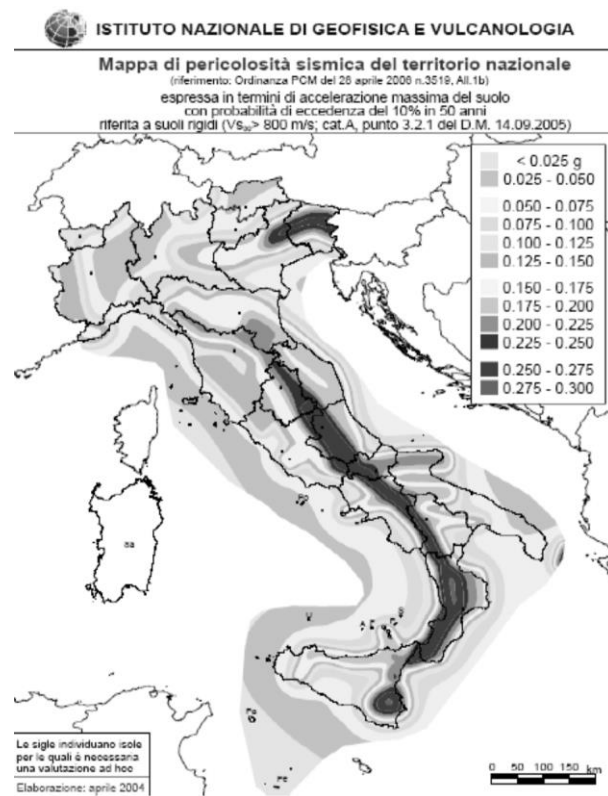

Fig. 3. Seismic hazards and seismic macro zoning in Italy

SEISMIC RISK IN THE WORKPLACE

The recent Consolidated Law on Health and Safety at Work issued in Italy with Decree-Law 81/2008 (TUS), supplemented by Decree-Law 106/2009, in compliance with European Directives on Safety compels employers to assess, manage and minimize all risks in the workplace, and subsequently draw a risks assessment dossier. This assessment should also take into account those risks related to possible natural disasters such as landslides, floods, earthquakes, etc.

Within areas classified by the seismic codes, seismic risk is closely associated with the requirements of stability and solidity set forth in Annex IV of the Consolidated Law. The first article provides that non residential buildings or any other facility in the workplace “should be solid and their solidity should match their intended use and environmental features.”

The employer, assisted by Prevention Coordinator and a physician, besides drawing a Safety Plan, must implement an action aiming at raising awareness on risks as well as a never-ending action to minimize them.

Prevention requires the implementation of an Emergency Plan to be adopted in case of a seismic event, which is an unpredictable natural phenomenon. This plan collects and explains all procedures to be activated depending on the kind of hazard, in order to minimize damages to people or things. It must be easily understandable and must tell exactly how to behave and what to do.

It contains the behavioural rules to be adopted and also a plan of the workplace in which you can see escape routes, paths to safe places indoor and the gathering point outdoor. It must become a document used for periodic check & training (with monthly earthquake drills) so that each operator knows exactly his/her tasks and duties.

Since earthquakes fall within emergency situations, employers are compelled under Article 18 of TUS to appoint in advance those workers in charge of the implementation of fire prevention and fire fighting measures, evacuation of the workplace in case of a serious or imminent danger, rescue, and first aid. They are also obliged to adopt measures to control risky situations in case of emergency and to instruct workers so that in case of a serious danger leave their workplace and discontinue their activity.

If there is no Emergency Plan, in case of an earthquake, once the seismic movement stopped, workers must immediately leave the building and move to a safe distance (at least 50 meters far from it or other buildings). If the building is damaged (cracks, broken glass, chipping plaster, clear inclinations or bending of load-bearing structures, etc..)-people should not go back indoor, unless they are formally authorized by Fire Department or Civil Protection engineers. The Prevention Coordinator and the physician in charge play an important role: they must give first aid and then refer to the psychological support team those in need of help.

SEISMIC RISK IN CONSTRUCTION SITES: A RESEARCH STUDY

In Italy, according to the regulations contained in Title II of the Consolidated Act on Safety temporary and mobile constructions sites are exempted from the implementation of those health and safety requirements included in Annex IV.

Although many requirements are aimed at already built structures, in sites dedicated to recovery or restoration of buildings we should consider the risk seismic especially in areas prone to earthquakes.

This issue became very topical in Italy after the recent earthquakes that struck L'Aquila and several towns in Emilia. Since in Italy earthquakes are frequent in different areas, we can affirm that the Italian territory is among the most prone to be struck by a seism. The recent laws focused on construction methods for new buildings and on restoration techniques for the ancient ones.

This research programme aims at developing a system to support safety control and management, which enables the real-time identification of risks and helps in the choice of the most effective actions to be implemented in order to eliminate or at least minimize the detected risk.

The programmatic approach to safety management in temporary and mobile construction sites is often led by the inability to identify risk situations that may still occur despite the correct planning of minimization interventions. And of course, since earthquakes are unpredictable, this planning has its limit. It is therefore necessary to determine new methods for risk identification and mitigation, while taking into account the need to check the occurrence of environmental conditions that, although infrequent, might become decisive in causing accidents. The project is divided into four research areas:

- Test of technologies to better understand seismic phenomena in the struck areas;
- Probabilistic models for real-time detection of risk situations;
- Methods for integrating monitoring solutions of real-time safety in construction management platforms;
- Systems and technologies for rescue and relief operations.

Before the beginning of this research study or by means of parallel studies, we are going to deepen our knowledge in the following:

- on going earthquakes, with particular reference to the areas most subject to seismic risk, thanks to data released daily by the Italian National Institute of Geophysics or other international agencies;
- methods for automatic detection of hazardous conditions of instability in temporary works which might result in workers falling from height or in the collapse of structures;
- identification of operational interference due to sharing of dangerous areas or team working in areas at risk;
- identification of dangerous situations in the implementation of emergency measures due to the occurrence of earthquakes;
- techniques for rapid location of workers buried by landslides or collapses to the ground or otherwise unconscious.

The program will be articulated in three steps.

Step 1: we are going to collect data on the hazard situations, in order to analyse their impacts on construction site activities.

Step 2: we will integrate technologies, so that the system becomes functional.

Step 3: we will gather the outcomes of test activities carried out in several construction sites. By doing this we'll be able to verify and, if needed, improve the reliability of the solutions for risk mitigation by testing them in real situations.

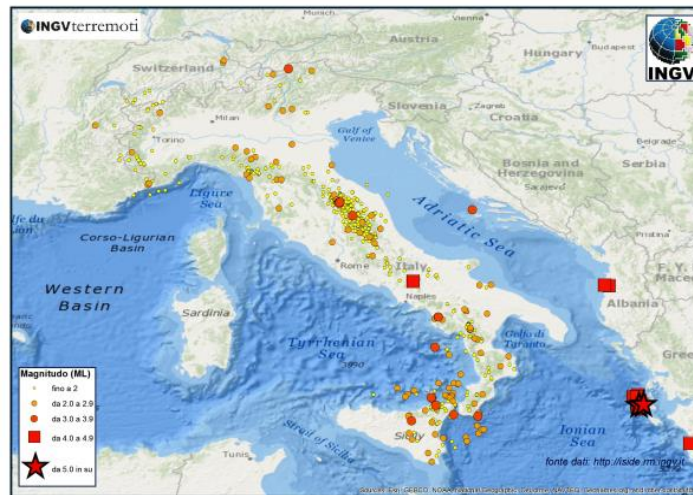

Fig. 4 Seismic activity January 1 -31, 2014, registered by the Italian National Seismic Network of the National Institute of Geophysics and Volcanology that detected a significant increase over the previous year.

FIRST OPERATIONAL GUIDELINES

After the earthquake that hit L'Aquila on April 6, 2009 local authorities and the Commissioner for Emergency had to organize works to secure public and private buildings flanking roads or built in critical areas, in the historic city centre and outside it. At the same time the coordination among reconstruction sites was put in place. This activity was the subject of a degree thesis of a student attending a master course in "Health and Safety Management in construction sites" recently held at the Università degli Studi Mediterranea di Reggio Calabria.

The seismic activity, which in the area of the Strait of Messina has been increasing for the last months, led to the adoption - on an experimental basis - of new elements in the management of some building sites in Reggio Calabria. Besides Safety Plans, we draw Integrated Emergency Plans, which dealt with the following six aspects:

1 - Specifications for site setup

In setting up the construction site we must take into account that we are working on a seismic area. We therefore need to carry out a precautionary morphological and geological survey on site, then foundations and anchorages of barracks to be used as logistic facilities must be designed according to earthquake-resistant criteria. The same goes for the installation of lifting equipment and the setting up of all temporary works. We must also identify a gathering point, inside or outside the site: it must be easily accessible and should not be hit by possible collapse of structures under construction or buildings next to the construction site. In case of contiguous sites we can identify special safe places whose management is entrusted to the local technical organizations. We are preparing some layout templates concerning this aspect, which could be verified via B.I.M.

2 - Permanent stability conditions

Before discontinuing activities for break periods; it's important to avoid situations which were not included in production cycles and could lead to some kind of instability. Moreover, we must stop any lifting equipment, plant and machinery in a safe position.

3 - How to behave in case of earthquake

In the event of an earthquake you must not use any lifting equipment. People must abandon immediately external scaffoldings, carpentry and in general any temporary work, and discontinue any activity on them, in order to avoid to be hit by falling structural overhangs (eaves, porches, balconies, etc.).

People must take shelter under tables or close to the safest structures (load-bearing beams, columns, perimeter walls, etc..) but away from glazed doors, windows, skylights or anything that might collapse or drop down.

Any energy supply must be disconnected.

4- Evacuation procedures

The most important point of the Emergency Plan: all workers in the site must be aware of its content. Therefore you must undertake preventive training actions and do earthquake drills in order to test the effectiveness of the measures envisaged.

At the end of the seismic movement, the Emergency Coordinator must immediately order the evacuation of the site and have the Emergency team to ask for help.

5 - First aid

If some buildings collapsed, remove debris at first manually. If you ascertained that there is someone beneath the debris, dig by hand in order to remove as much debris as possible and create a kind of path to reach injured people.

6 - Post - earthquake check

Before resuming any activity, you must verify the conditions of stability and the normal functioning of all the lines and supply networks of the site, machineries, plants, equipments, temporary works. This check must be carried out by experienced workers under the guidance of a supervisor.



Fig. 5 - 6 Implementation of the protections in a restoration site in an area of high seismic risk (left). Shoring at a yard provisional reconstruction after the earthquake (right).

CONCLUSIONS

Our work started a few years ago through a preliminary survey of the issues to be addressed; over the last year we compared it with operational measures that companies working in Emilia Romagna are required to implement in reconstruction building sites. These measures are the outcome of the first tests carried out in L'Aquila. In just over a year has proposed operational modes of organization of construction sites for the safety of damaged structures, the kind of demolition, restoration and reconstruction. In addition to the research program defined some specific monitoring were activated and planning aspects that relate to the issues of reconstruction sites (interference, community services demolition of the ruins which contain asbestos , etc.).

The useful information that flows from those areas that are joined to the experiments in yards operating in areas of high seismic risk have increased the challenge of the goal of building operational tools that take into account the prevention of security to be implemented before damaging events (expected seismic event) and after earthquakes (repetition of events with seismic swarms or replicas).

REFERENCES

- Celastini, G, Mantini, G (2012), "Misure di prevenzione e protezione per la manutenzione dei sistemi di sicurezza e delle opere provvisorie realizzate sui manufatti a seguito di eventi calamitosi", ANCE, CPT L'Aquila.
- (2012) "Linee Guida per la tutela della Sicurezza e Salute dei lavoratori a seguito di Evento Sismico", CGIL Pesaro.
- Høj, NP (2001), "Risk and Safety Consideration at different project phases". In IABSE ,Safety, Risk, and Reliability - Trends in Engineering, Proceeding of International Conference Malta.
- Gilbertson, A, Kappia, J, Boshier, L, Gibb, A (2011), Guidance on catastrophic events in construction, CIRIA London.
- Menduto, T. (2011), "Edilizia: le misure di sicurezza contro i rischi naturali", in Punto Sicuro.
- Amaddeo, S (2012), "Il cantiere in zone colpite dal sisma: Scenari di rischio e procedure operative per la sicurezza", Unpublished M Thesis, Department Darte, Università degli Studi Mediterranea, Reggio Calabria, Italy

DISTRIBUTION OF BREAKS IN THE CONSTRUCTION INDUSTRY

Dieter Schlagbauer³⁸ and Detlef Heck³⁹

¹ *Graz University of Technology, Institute for Construction Management and Economics*

The performance of tasks with a high physical load corresponds very strongly with the necessity for breaks and therefore these breaks should be taken depending on the workload. The actual situation on construction sites is different since breaks were traditionally arranged, almost unchanged over the last decades and especially in no connection to the work load. These statement was proofed by a recent survey of supervisors (N = 64) and construction workers (N = 177).

The results of the survey showed that the majority would not change the current break arrangement and also supervisor didn't see the importance of the break distribution.

The idea of the paper is supplemented by statements of the construction workers unions to reduce stress caused by the high temperatures in the summer months in recent years.

The resulting new approach for customized breaks in connection to physical load based on discovered basics lead to the following suggestion: The overall working time should be split into three almost comparable shares with a duration of 2.5 to 3.5 hours to reach the total of 9 to 10 working hours. But even if these breaks are changed in the suggested way, the authors would recommend additional breaks if the construction workers have to perform very strenuous work or the climate conditions have an additional high impact on the strain.

Keywords: break distribution, work load, survey.

INTRODUCTION

The performance of tasks with a high physical load corresponds very strongly with the necessity for breaks. Therefore breaks should be taken depending on the work performed. But the situation on construction sites is rather different to other industries. Within the construction industry breaks are often traditionally arranged, their allocation has almost been unchanged over the last decades and in most cases they are not set in connection to the work load.

RESEARCH PROJECT AND TARGET

In 2012 a research project was established in order to evaluate the actual situation of breaks as found in Austrian construction industry nowadays and to show an approach to improve the work / rest situation for all construction workers. The target of this paper is to present the results of the analysis as well as a new approach to improve the actual situation.

³⁸ dieter.schlagbauer@tugraz.at

³⁹ detlef.heck@tugraz.at

VALUATION OF THE BREAK SITUATION

Method

The introducing statement was topic of the survey attended by supervisors and construction workers. In this survey both groups had to evaluate the break situation status of construction workers from their point of view. The questionnaire was sent to different construction companies in Austria via mail and E-mail. 241 were returned and could be analysed; of which 64 Questionnaires were answered by supervisors and 177 by construction workers.

For both participating groups the form consisted of three parts:

In the first part of the questionnaire general information was gained in order to classify the attendants by age, duration of working in the construction industry and their working sector.

In the second part the start of work, times of breaks and end of work as well as the daily departure time from home to work for each day of the week were collected. Additionally questions concerning the usage of and the necessity for breaks were conducted. Furthermore the construction workers were asked if they were hungry when starting each break.

The third part of the questionnaire was split: the supervisors had to evaluate the actual break situation of the construction workers and the workers had to evaluate their own situation. Additionally they had to articulate their opinion to the statement “A different break distribution could result in higher productivity”.

Data analysis

General Information

By executing the data analysis general information about the attending supervisors and construction workers was gained.

Table 1: Duration of employment for the participation persons

	N	Mean Age	Duration of employment at the actual company
Supervisor	64	36,25	11,20
Construction Worker	177	41,09	14,55

The duration of employment for the investigated construction workers is displayed in the next diagram, which illustrates more than 50 % of the participants are employed less than one year in the current company.

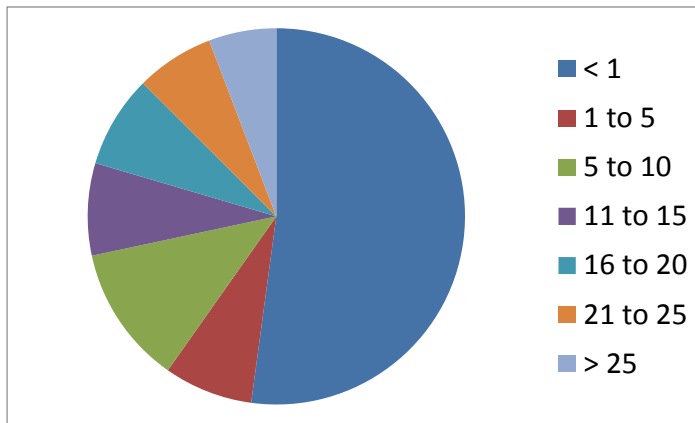

Diagram 1: Duration of employment at the actual company

Additionally the sector within the construction industry for supervisors and workers is displayed in the following diagram:

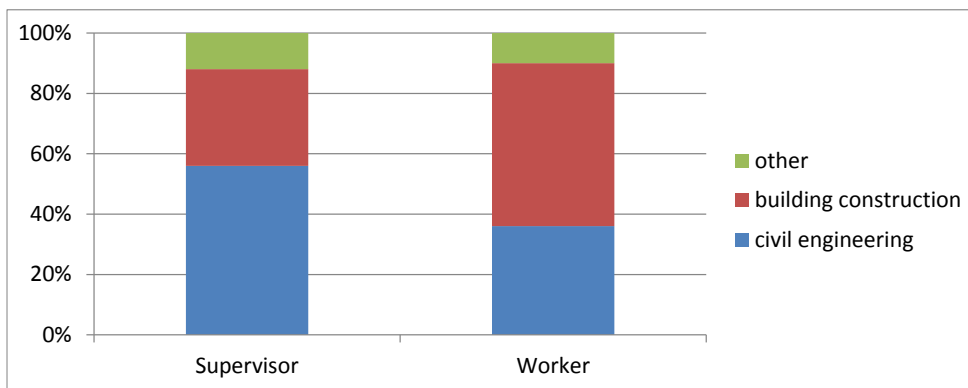

Diagram 2: Sector of employment

Break situation

The next part of the analyses took a closer look at the time and length of the occurring breaks, which resulted in a smaller range of break time and length but in a wider range for the start and end of each work day.

Table 2: Distribution of breaks

		start of work	Forenoon break	Duration	Lunch break	Duration	Afternoon break	Duration	End of Work
Supervisors		5:45-8:00	9:00-9:30	15-30 min	12:00-12:30	25-60 min	15:00-15:30		16:30-18:00
	mean			19,45 min		41,16 min			
	N			41		60			
Workers		4:30-8:00	9:00-10:00	10-30 min	11:30-12:30	20-60min	15:00	15-30 min	16:30-19:00
	mean			21,95 min		38,13 min		18,2 min	
	N			100		129		28	

The most remarkable outcome is that the time between breaks becomes longer and longer during the course of a work day, while a break in the afternoon was found only for a very small share of the participants.

The wide range of the start of work can be explained by two factors: (1) the time leaving home and (2) the travel time to the site. Based on this differentiation two types of construction workers can be named: (i) on one hand construction workers who live at home and drive to the site each day, which usually takes about 75 minutes each way and therefore the homes have to be left very early; (ii) on the other hand, nearly 40 % of construction workers are accommodated in a close range to the site, which reduces the driving time to a mean value of 34 minutes.

In connection to the distribution of breaks the intended use of breaks had to be answered: 97 % of the foremen suppose that construction workers use their breaks for recovery while only 83 % of the workers actually say that they need the break for recovery. In order to gain a clearer statement on the intended use, additional questions for the construction workers were prepared. Based on these questions their need and time for meals was examined and combined answers resulted in the figure shown below.

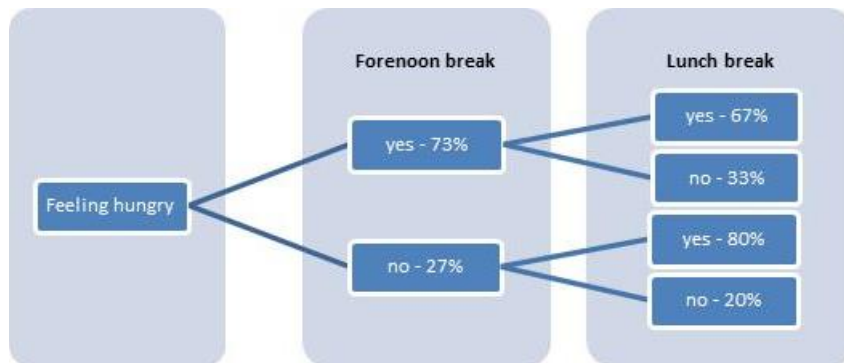

Diagram 3: Feeling of hunger and breaks

The answers also showed that only 56% of the construction workers had a breakfast before they left home and 11 % used the first break for lunch. Concerning the structure of genuine breaks, only 3 % of the construction workers would change the starting time of the forenoon break or have an additional break, if there is currently no break; 6 % would delay the lunch break point for approximately 30 to 60 minutes; 17 % of the construction workers would like to have an additional break in the afternoon; compared to the 17 % who answered that they actually have a break, the total share of 34 % is rather a small number of workers who would actually prefer a break in the afternoon. Supplementary remarks of the construction workers lead to the result breaks should be set according to the work load or boundary conditions such as temperature or humidity.

In addition, only 8 % of the foremen and 12 % of the construction workers thought that restructuring the breaks could improve the situation of the construction workers and also lead to an economical benefit within the range of 3 to 20 %. This economic benefit is important since it is the only reason for a company to change the way of their usual break distribution, besides changes set by governmental regulations.

RESULTS OF THE ONSITE OBSERVATIONS

The questionnaire and onsite observations were simultaneously performed in order to display the actual break distribution based on multi-moment-analysis (Schlagbauer 2011 and 2012a). This investigation took place at different seasons within one year at seven construction sites.

Table 3: Distribution of Interruptions due to recreation and personal needs

Hour	A.M						P.M						Total
	07:00	08:00	09:00	10:00	11:00	12:00	1:00	2:00	3:00	4:00	5:00	6:00	
Total number of tasks recorded	1646	1626	1653	1646	1611	1549	1507	1511	1444	1242	672	27	16.134
Restricted breaks	0	9	696	45	27	920	7	8	0	0	0	0	1.712
Individual Breaks	10	41	19	53	66	7	66	139	145	100	13	0	659
Interruption due personal needs	13	29	20	36	43	2	27	32	66	16	4	0	288
Total number of Breaks recorded	23	79	735	134	136	929	100	179	211	116	17	0	2.659

The total number of single task recordings is over sixteen thousand which contains the share of 2.659 recreation tasks.

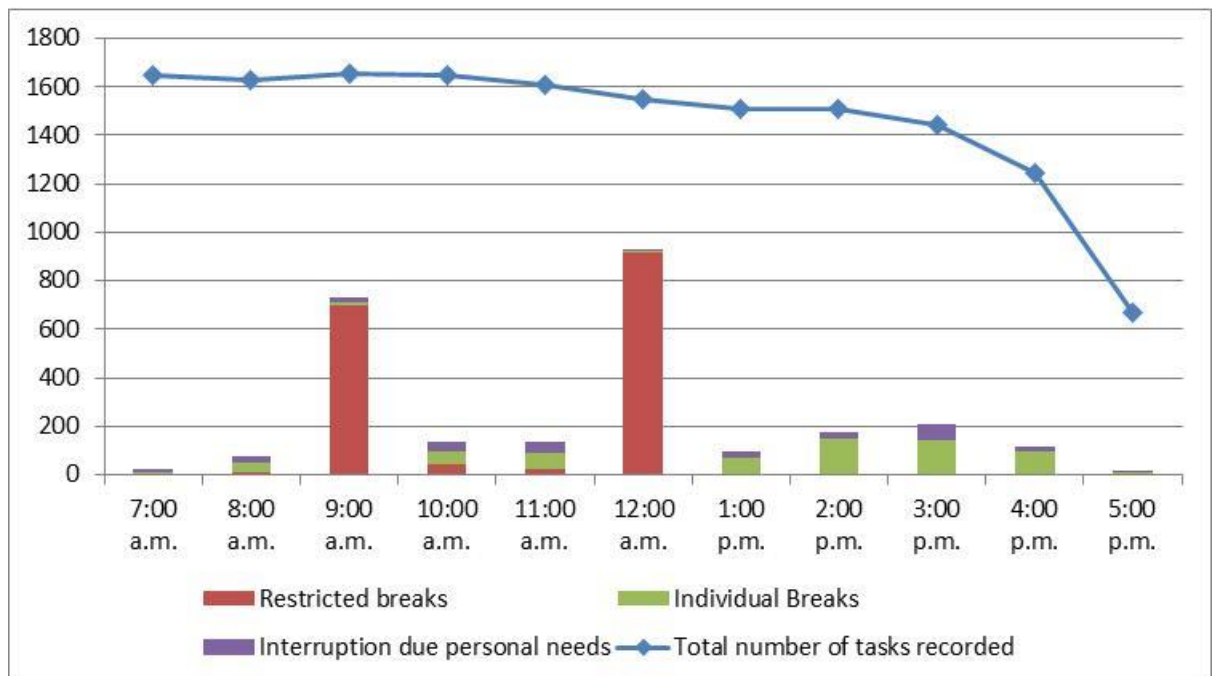

Diagram 4: Distribution of Interruptions due to recreation and personal needs

The distribution over the day shows that most of breaks can be found between 9:00 and 10:00 a.m. as well as between 12:00 and 1:00 p.m. and only very few later in the afternoon. Therefore the results of the questionnaire were proved by this on site investigations.

WORK / REST SCHEDULES AND WORK TIME REGIMES

Besides the results of the investigation the importance of work /rest schedules can also be seen in literature. An important topic in the working time society is the length of shifts (Wong and Gaertner, 2013) as in the construction industry in Europe the usual construction projects – except for tunneling works – is based on an 8 to 10 hour shift from Monday to Friday with a number of usual hours worked each week of 40 to 50. Wong and Gaertner (2013) published different papers concerning the connection of shift-length and the benefits gained.

Tucker and Folkard (2012) present a theoretical framework, which covers (i) the relation between work hours and occupational health and safety, especially in connection to daily working hours and weekly working hours, (ii) the benefits from different working time arrangements on occupational health and safety and (iii) the impact of working hours and working time arrangements with the special target of minimizing the resulting adverse effects.

When trying to apply similar working time arrangements in the construction industry, a strong resistance can be found mainly based on the long tradition and the little will to change the actual system, especially by the construction companies since their benefits are unclear or hard to break down into money values.

Despite this conflict, Tucker and Folkard (2012) show, that the arrangement of working hours has become a crucial factor in work organization, with important economic and social consequences concerning both employees and employers and therefore the construction industry will have to deal with a change in the work and rest schedules for their employees. But this change will not be implemented over the next years, since other sectors of the industry are more in the focus of safety and health regulations, as these sectors have more unusual working time arrangements.

According to the Third European Survey on Working Conditions, only 24 % of the working population was engaged in "normal" or "standard" day work, from 7 to 8 a.m. and 5 to 6 p.m., from Monday to Friday (Costa et al., 2004). As construction workers usually practice this time scheme their type of working schedule seems to be "normal" compared to other industries. The more important influences on construction sites are extended shifts.

The ILO - the International Labour Organization – published that the amount of extended working (for longer than 8 to 9 hours per day, and 40 hours per week) the annual hours worked per person exceeded 1,800 (i.e. 36 hours per week for a 50-week year) in 27 out of 52 countries monitored from 1996 to 2006, and 2,200 hours (i.e. 44 hours per week for a 50-week year) in six Asian economies (ILO, 2007). In the United States, almost one third of the workforce has to perform more than the standard 40-hour week and one-fifth more than 50 hours regularly (US Bureau of Labor Statistics, 2005). In Europe, according to the Fourth European Survey on Working Conditions, 16.9 % of workers in the 27 European Union Member States worked 48 hours per week or more, ranging from 11.1 % in Luxembourg to 32.1 % in Turkey (Parent-Thirion et al., 2007).

While Tucker and Folkard (2012) point out the unclear evidence of extended shifts for an overall adverse effect on job performance, Tucker in 2006 and Schlagbauer(2012a) showed the influence of working hours on the production performance of construction workers for tasks with lower and higher straining activities. Focusing on work schedules a large number of studies examined the health impact of different work schedules (E.g.: Costa et al. 2010 and C.S. Smith et al. 2011). Also, in connection to rest breaks, several studies observed the role of breaks in preventing musculoskeletal problems, although systematic reviews suggest that there is only limited evidence of their effectiveness in this regard (Brewer et al., 2006; Kennedy et al., 2009).

Moreover, insufficient rest breaks during the day can be associated with increased work-related stress (Smith et al., 2009). Recent research has indicated that the benefits of rest breaks on stress and strain are influenced by the nature of the activity undertaken during the breaks (Krajewski et al. 2010). Verbeek (2013) additionally asked a question, not trivial to answer: "Should construction workers work harder to improve their health?" and presented different papers, which show the problem of defining and investigating work ability. Focusing on construction work Hengel et al. (2013) presented the ineffectiveness of construction worksite prevention programs considering work ability, health and sick leave since the only benefits for the construction workers were found in an overall decline in the prevalence of musculoskeletal symptoms and long-term sick leave among construction workers.

A theoretical framework used to schedule breaks according to the actual working situation was shown by Hsie et al. (2002) based on the findings and publications of Konz (1998a und 1998b). Hsie et al. designed a calculation for the maximum acceptable work duration (MAWD) based on the physiological factor oxygen consumption (VO_2) in relation to the individual maximum oxygen consumption ($VO_{2,max}$) and the oxygen consumption at work ($VO_{2,work}$). The key in order to establish this calculation is the identification of the before described oxygen consumption amounts, especially during work. Measuring these values is hard to execute when highly straining work is performed, therefore, in exchange the heart rate can be monitored and the oxygen consumption calculated based on additional laboratory tests (Abdelhamid and Everett (1999), Schlagbauer (2012b)). Abdelhamid and Everett also presented mean physiological values for different trades within the construction industry.

Grübler (2012) combined the ideas of Hsie et al. (2002) and Schlagbauer (2012a and 2012b) in order to monitor bricklaying tasks. Grübler indicated that actual breaks were sufficient for the investigated work load at forenoon, but in the afternoon, the missing of restricted breaks leads to additional individual breaks to cover the work load. In this work it was also pointed out that, if the ability to set individual breaks was missing due to several reasons (in most cases the kind of the work process of construction operations), a reduced output performance was found. Besides the strain of the work also the individual physiological ability was a major influence for the necessity of recreation breaks. Schlagbauer (2012b and 2013) presented a calculation model which predicts the heart rate of selected construction work tasks (bricklaying and concreting work) in order to forecast the output performance level in the course of a work day. This calculated heart rate can also be applied in order to set individual breaks according to the work load.

CONSTRUCTION OPERATION INFLUENCES

Additional to physiological influences the construction work process often prevents the workers to set their breaks individually or at the right moment. Since the construction industry is mainly based on economic targets, the achievable performance can be named as additional influence on the possibility and distribution of breaks. Hofstadler (2005) presents five major influences on the performance („daily working time“, „perturbation“, „training level“, „practice level“, „number of worker“ und „output performance value“) which have to be considered in the planning phase and later in the distribution of tasks by the foreman.

A connection between the factors „daily working time t“ and „training level“ as well as „practice level“ and the break situation is assumed. The maximum daily working hours are set by government regulations which are often the usual duration and not the maximum, since more and more projects are running on a tight or not fulfillable schedule. Skilled workers are more favoured since they need less time to become acquainted to the processes on different construction sites and can work quicker on a higher performance level. Additionally the tasks which have to be fulfilled by one worker were reduced and more specialists can be found on a site. This also leads to an improved performance since training levels of the tasks carried out are very high, but the need for more different works also went up.

Looking at the daily schedule it is important to keep in mind, that the work place on the sight can't be left without preparation (e.g. safety works). Additionally a lot of construction sites are nowadays located within town centres and therefore the construction has to be clean at every break and when the workday is over. Before each break there are at least 5 to 10 minutes of safety preparation or cleaning works to day. After each break the workers also need 5 to 10 minutes to get back to their workflow. Usually construction sites have a recreation area, additional time is needed to get from the work place to the rest area and back to work, especially at high rise buildings or in tunnels this takes a long time if the transportation is not planned well.

Therefore it is impossible to set very short individual breaks at any time of the day without a reduction of the economic output. The often suggested micro breaks, which last only 3 to 5 minutes are only possible if they can be integrated in the construction process. It is usually impossible for Construction company owners to plan such breaks; in conclusion they can only be conducted if they are arranged by workers and foremen on site.

PROPOSAL FOR A CHANGED BREAK DISTRIBUTION

Based on the questionnaire and additional collected statements of company owners the construction companies are only willed to set breaks according to the government laws, in the Austrian construction industry the regulation forces at least on break with a duration of 60 minutes, but this break can also be divided into several shares.

Bringing different positions of company owners with their strong economic view and the need of the workers for well distributed breaks together the following break allocation is recommended:

The overall working time should be split into three almost comparable shares with a duration of 2.5 to 3.5 hours to reach the total of 9 to 10 working hours, which would lead to the following moments for an eight or ten hour workday:

Table 4: Allocation of breaks for different working hours

	Actual break allocation for 10 Working hours	8 working hours	10 working hours
Start of work:	7:00	7:30	7:00
1st break:	9:00 to 9:20	10:30 to 11:00	10:30 to 11:00
2nd break	12:00 to 12:40	14:00 to 14:30	14:30 to 15:00
End of Work	18:00	16:30	18:00

As in the table presented, the idea is to set the first and second break later at the day to reduce the long working period in the afternoon without a fixed break, but also to keep the total break time and number of breaks on the same level.

But even if these breaks are changed in the suggested way, the authors would recommend additional breaks if the construction workers have to perform very strenuous work or the climate conditions have an additional high impact on the strain (Schlagbauer, 2012b).

CONCLUSION

The evaluation of the break situation status in the construction industry was topic of a questionnaire answered by 241 participants of which 64 Questionnaires were answered by supervisors and 177 by construction workers.

Concerning the structure of genuine breaks, only 3 % of the construction workers would change the forenoon break; 6 % would delay the lunch break and 17 % of the construction workers would like to have an additional break in the afternoon. Supplementary remarks of the construction workers lead to the result breaks should be set according to the work load or boundary conditions such as temperature or humidity. In addition, only 8 % of the foremen and 12 % of the construction workers thought that restructuring the breaks could improve the situation of the construction workers and also lead to an economical benefit.

Based on different discovered basics a new approach for customized breaks in connection to physical load was suggested: The overall working time should be split into three almost comparable shares with a duration of 2.5 to 3.5 hours to reach the total of 9 to 10 working hours. But even if these breaks are changed in the suggested way, the authors would recommend additional breaks if the construction workers have to perform very strenuous work or the climate conditions have an additional high impact on the strain. These additional breaks can be set based on a recently discovered calculation model for the stress and strain of construction work tasks.

Based on the presented ideas future research projects should be established to evaluate the outcome of the different break situation and to discover influence factors for additional like temperature or humidity.

REFERENCES

- Abdelhamid, T. S.; Everett, J. G.: Physiological Demands of Concrete Slab Placing and Finishing Work, in: *Journal of Engineering and Management* Jg.125, 1999, P.: 47-52.
- Brewer et al.: Workplace interventions to prevent musculoskeletal and visual symptoms and disorders among computer users: a systematic review, in: *Journal of Occupational Rehabilitation*, Vol. 16, No. 3, , 2006 P.: 325-358
- Costa et al.: Flexible Working Hours, Health, and Well-Being in Europe: Some Considerations from a SALTSA Project, in: *Chronobiology International*, 2004, P.: 831–844
- Grübler C.: Analyse von Belastungsfaktoren und Gesundheitsrisiken im Bauwesen, Diplomathesis TU Graz, Graz 2009.
- Hengel et al.: The effectiveness of a construction worksite prevention program on work ability, health, and sick leave: results from a cluster randomized controlled trial, in: *Scand J Work Environ Health* 2013;39(5), 2013, P.:456-467
- Hofstadler, C.: Bauablaufplanung - Interaktionsdiagramm für Bewehrungsarbeiten, in: *Baumarkt und Bauwirtschaft*, Heft 01, 2005, P.: 55.
- Hsie, M. et al.: A model used in creating a work-rest schedule for laborers, in: *Automation in Construction*, Jg.18, 2009, P.: 762–769.
- ILO: Kilm 06 (Geneva), 2007.
- Kennedy et al.: Systematic review of the role of occupational health and safety interventions in the prevention of upperextremity musculoskeletal symptoms, signs, disorders, injuries, claims and lost time, in: *Journal of Occupational Rehabilitation*, Vol. 20, No. 2, 2009, P.: 127-162.
- Konz S.: Work/rest: Part I - Guidelines for the practitioner, in: *International Journal of Industrial Ergonomics*, Jg.22, 1998, P.: 67–71.
- Konz, S.: Work/rest: Part II - The scientific basis (knowledge base) for the guide, in: *International Journal of Industrial Ergonomics*, Jg.22, 1998, P.: 73–99.
- Krajewski et a.: Regulating strain states by using the recovery potential of lunch breaks, in: *Journal of Occupational Health Psychology*, Vol. 15, No. 2, 2010, P.: 131-139.
- Parent-Thirion et al.: Fourth European Working Conditions Survey, European Foundation for the Improvement of Living and Working Conditions, 2007.
- Schlagbauer et al.: Interdisziplinäre Research Project: Principles of Work Scheduling; in: *Modern Methods and Advances in Structural Engineering and Construction*, 2011, P.: 117 - 122
- Schlagbauer et al.: Integration of Sports Scientific Knowledge in the Scheduling of Construction Projects; in: *Research to Practice*, 2012a.
- Schlagbauer et al.: Workload and task distribution in formwork and masonry work. - in: *CIB W099 International Conference*, in: *Modelling and Building Safety*, 2012b.
- Schlagbauer, D.; Heck, D.: Change in output performance due to prolonged work. ISEC Conference, 2013.
- Smith et al.: Examining the dimensions and correlates of workplace stress among Australian veterinarians, in: *Journal of Occupational Medicine and Toxicology*, Vol. 4, 2009, P.: 32.

- Smith et al.: Work schedules, health and safety, in J.C.Quick and L.E. Tetrick (eds):
Handbook of occupational health psychology, 2nd ed., Washington, DC, American
Psychological Association, 2011.
- Tucker, P.: Compressed working weeks, Report for ILO, 2006.
- Tucker and Folkard : Conditions of Work and Employment Series No. 31. – Geneva: ILO,
2012, P.: 60.
- US Bureau of Labor Statistics. 2005. Occupational outlook handbook, retrieved from
www.bls.org, 28.02.2014, 11:58 p.m.
- Verbeek J.: Should construction workers work harder to improve their health?, in: Scand J.
Work Environ Health, 39(5), 2013, P.:427-429
- Wong and Gaertner: In what situations would 8 hour shifts be more beneficial, and when
would 12 hour shifts be better? - A collection of interesting papers collected by WTS-
members; retrieved from:
<http://workingtimesociety.memberlodge.com/8hoursversus12hours>; 28.02.2014,
11:58 p.m.

THE APPLICATION OF DEDUCTIVE LOGIC TO DETERMINE THE OBJECTIVE CONDITIONS IMPACTING UPON CULTURAL MATURITY

Ciaran McAleenan⁴⁰ and Philip McAleenan⁴¹

¹ *Ciaran McAleenan 1 School of the Built Environment University of Ulster, Jordanstown Campus,
Shore Road, Newtownabbey BT37 0QB, N.Ireland*

² *Philip McAleenan 2 Expert Ease International, Downpatrick BT30 6HB, N.Ireland*

A competent company has a level of cultural maturity wherein its strategy, managerial structures and policies, and the way in which it acts all converge to ensure that it meets its responsibilities to its workforce and those affected by what it does. Culture is the way in which the company behaves regarding critical business factors, including safety, and maturity is the ability of the company to react, handle difficult situations and reason in an appropriate way in each situation in the achievement of its objectives. All too often it is 'safety culture' that becomes the metric and this research contends that rather than focus on one aspect of culture it is the 'cultural maturity' of an organisation that is the most authentic reflection of its competence and one of the most powerful elements affecting its long term success.

The signing of the Seoul Declaration on Safety and Health at Work combined safety and health of the workforce with human rights as enshrined in the UN Declaration on Human Rights; the effect being that safety must not be treated as an adjunct that can be added to or subtracted from the work process according to how well the 'bottom line' is doing. Accordingly, determining the status of an organisation's cultural maturity affects its development and future growth in the context of its social and human obligations, boosting safety performance in concert with business performance.

This paper describes the developmental research associated with the production of a diagnostic tool that measures the cultural maturity of an organisation with specific emphasis on qualifying the leadership competencies emerging from policies and practices. The research output is a diagnostic tool that analyses the apparently immeasurable intangibles of organisational culture to produce tangible and significant performance improvement solutions in a safe and sustainable manner.

Keywords: Cultural Maturity Index, OAC, OCMI, Operation Analysis and Control, Praxis.

BACKGROUND

For many companies, coming to terms with the requirements of the Health and Safety at Work (HASAW) Act 1974 or the HASAW (NI) Order 1978 meant a long period of learning. Perhaps it would be more accurate to say that it took a long time to develop an understanding of the main requirements of the health and safety legislation. One of

⁴⁰ c.mcaleenan@ulster.ac.uk

⁴¹ expertease@confinedspaces.com

the key ideas in the production of the new legislation was the desire to replace the mass of existing legislation with one single Act that would apply to all workers. The prime obligation for employers was to be aware of all the hazards associated with their industry and to put in place sufficient control measures to protect their workforce. While the principle was sound, the practice and degree of compliance varied significantly across the UK and across the different industry sectors (McAleenan and Orr 1999). The development of a Single European Market in the early 1990s brought more challenges. Differing standards and legislative requirements across the European Union (EU) member states were so significant that the potential for cross-community competition was seriously impaired. Accordingly the EU took steps to address the issues raised by this situation and at the same time give a renewed impetus to the direction that occupational safety and health should be taking. The direct effect of EU intervention was to make explicit that which had been implied in the original HASAW legislation in UK and in particular, the new legal requirements placed risk assessment at the heart of health and safety management. Further in USA, although faced with a different emphasis, absolute requirements to act according to Federal Regulation, businesses were faced with similar risk managed approaches to operational safety.

Despite the sizeable regulatory position in each of the jurisdictions the problem remained; accidents were occurring in substantial numbers, while the focus in business appeared to be centred on the consequential paperwork. And while the risk assessment/risk management approach did have some successes in the early to mid 1990s it appeared to have reached an equilibrium that would not be breached so long as the bureaucracy, spawned since the enabling of the regulations, remained the dominant preoccupation (Works and Pensions Committee 2008). Since 1941, the International Labour Office has collected statistics on occupational injuries for publication in the Yearbook of Labour Statistics while in 2002 (ILO 2002) they freely acknowledged that the reporting mechanism was unreliable and that they were working on estimates that they believed were grossly underestimated. At that time the global fatality rate for work-related deaths was estimated to be 1.2m. Later improvements in the reporting mechanism and returns from a greater number of countries have put the most recent figure at 2.3m (ILO 2011).

Risk assessment and more particularly risk management failed to produce the critical mass needed to deliver a safe and healthy global workplace. What appeared to be the resultant popular opinion was that there was an acceptable level of risk and while no one was likely to explicitly state they would accept fatalities in their operations the actions, demonstrated by the approach to safety, coupled with the global fatality statistics would appear to suggest otherwise. It would be unfair to suggest there was a widespread callous attitude to safety; rather the extent and the scale of the problem demonstrated an urgent need for initiatives that could reverse the current upward trends in work related accidents and occupational diseases. Recognising the problem and acknowledging its extent the research presented in this paper was embarked upon with the intention of offering an alternative. The aim of the research was to demonstrate how the application of dialogics develops critical consciousness, providing the intellectual capacity to know how to safely control workplace operations and in the process establish links between competence, cultural maturity and ethics reasoning.

RATIONALE

Gramsci, (cited in Löwy, 2011) used, for the first time, the expression “philosophy of praxis⁴²”, which Löwy (2011) perceived as defining Marx as a worldview. The philosophy of praxis, practiced in workplace safety and health sets a standard far beyond the quality paradigm in as much as quality relies upon a rigid consistency of approach to deliver a predetermined outcome (product or service), same way, same thing, every time. Where praxis has some similarities with Deming (1986), Juran (1998) and Crosby (1979) is in its adherence to planning and control, however the essential difference, and what sets it apart is the critical reflection at each point of checking reflecting that change has already taken place and the journey itself may also have changed (Figure 1). The rigidity within the quality models exposes their fixation with consistency of approach regardless of whether the direction is right, failing to contextualise with society other than as a commodity. Profit drives the change and in that rests the question, where is the societal responsibility? It is not necessarily about doing things wrongly rather it could be about doing the wrong things. Dialogics on the other hand recognises society as an integral aspect of what is produced. It is not an abstract concept, rather it establishes that workers analyse the impact of the work on themselves, their colleagues and calls upon them to consider the wider harm the work and/or the product might have on society.

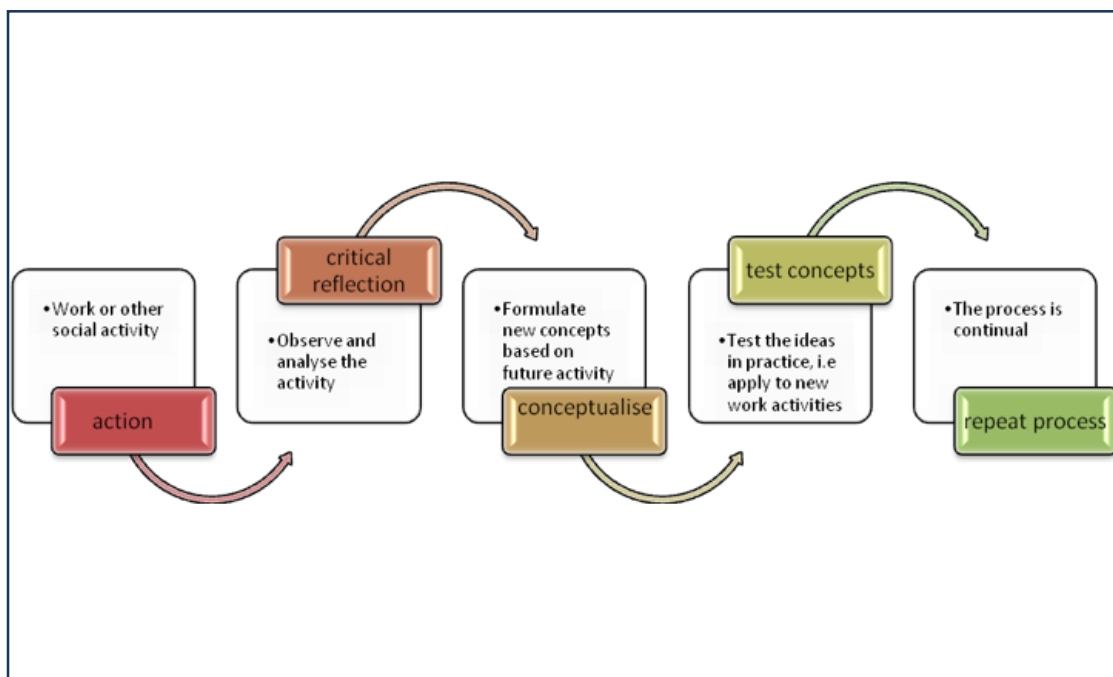

Figure 1: The Praxis Model for OSH Management (McAleenan and McAleenan)

At the extreme the munitions worker, the tobacco plantation worker or the operative on the line at the cigarette factory all have a role in analysing the degree of harm they are likely to be exposed to, but what of the harmful effects of the end product. For them harm comes in many ways and protection of their livelihood will determine the objective meaning behind decisions they make. This presents a sense of powerlessness/ alienation in the workers, until through the praxis approach they grasp

⁴²The term used by Aristotle for ‘making’ was “poesis,” and the word he employed for ‘doing’ was “praxis.” It is this term associated with ‘doing’ that formed the basis for the development of the advanced social activist tool; the praxis model, predominant in the strategic thinking of 20th century socially responsible educationalists.

the opportunity to recognise and address some of the dilemmas of competing objectives (McAleenan and McAleenan 2010b). Factory or plantation owners however have a chance to explore the societal aspects of the praxis model.

OPERATION ANALYSIS AND CONTROL APPROACH

The Operation Analysis and Control (OAC) approach (McAleenan and McAleenan 2002), based on the premise that work activities must be viewed and carried out holistically with no unnecessary separation and devolvement of functions to others, particularly in the realm of critical decision making vis-a-vis safety. With OAC the objective is not in reducing the risk, rather the case is presented for managing any operation in any hazardous environments such that with full knowledge of all the hazards and of the necessary control measures there is no risk. Managing risk is balancing (or trading off) the known with the unknowns in the expectation of a successful outcome. If safety, not the risk, is managed and the safety of the operation is controlled, i.e. all hazards and the appropriate controls are in alignment, then it does not matter how hazardous the environment is since, with OAC, the operation itself is non-hazardous and the outcome will always be non-injurious.

As the OAC approach was being introduced to businesses (McAleenan and Orr, 1999, McAleenan and McAleenan 2002, Ayers and McAleenan 2008) it was being refined in use and through regular presentations to gatherings of professional bodies; such as safety, construction, engineering and academic. Each refinement was a logical development of preceding concepts, starting with the holistic approach to workplace safety, through the application of the principles of effectiveness to work management, to the rational re-integration of responsibility and authority to make decisions related to the work being undertaken. In the process it has become apparent that realistic considerations of work activities must see them in context, not simply of their relationship to other activities on the shop floor or construction site, nor indeed of their context within the overall company in which they occur, but also in the context of their wider affect on social and environmental matters; locally, nationally and globally. The twin objectives for the sustainability of any business is for its activities to be good for the individual worker and good for the company and in this we have echoes of Fromm (1947) who contends that what is fundamentally good for the individual must, of necessity, be good for humanity.

SEOUL AND CULTURAL MATURITY

The third paradigm in the Seoul Declaration (ILO 2008) states:

“occupational safety and health requires a fundamental conceptual shift towards the creation of a culture enhancing workers’ well-being and welfare, away from a myopic focus on responsive accident-prevention activities”

Sir John Egan (1998) reporting to UK’s Deputy Prime Minister on the state of the construction industry specified that; “If the industry is to achieve its full potential, substantial changes in its culture and structure are also required to support improvement...” In recognition of this McAleenan and McAleenan (2010b) concluded that “[a]n evolved company is one that has the intellectual and technological capabilities to prevent workplace accidents and at the same time achieve its objectives without being risk averse”. Previously McAleenan and McAleenan (2009) had discussed the link between competent companies and cultural maturity in the context of the Seoul Declaration (ILO 2008). Until then OAC never had a specific audit tool

since it was not some new management system to sit on top of all other management systems, rather it is an approach or thought process, which readily integrates with whatever management style exists in the company, flexible enough to adapt to any style and robust enough to stay the pace. Once embedded in the company it can be measured against any of the international management specifications; quality, environmental or safety; including ILO-OSH guidelines (ILO 2001).

However the discourse, associated with the third paradigm, took OAC to another level and to the refinement of preexisting diagnostic tools (McAleenan and McAleenan 2009) to allow organisational cultural maturity to be addressed and measured. Delving into the intent behind the third paradigm and exploring some of the relevant definitions the following is held to be true:

- A competent company is one wherein the strategy, the managerial structures, policies and the way in which the company acts to meet its responsibilities towards all the stakeholders combine in a way that; ensures the safety of its workforce and those affected by what the company does, enhances the quality of its output, and satisfies the fiscal needs of the owners in a sustainable manner.
- Workplace Culture is the way in which the company behaves regarding critical factors such as safety, sustainability and stakeholder rights, and the structure is the way in which it organises itself to achieve its objectives.
- Quality companies demand exemplary work practices and excellent conditions throughout and to obtain these assess how competence is viewed and practiced.
- Cultural maturity is when a company demonstrates that it has the necessary attributes essential to achieving success in health and safety, productivity and meeting its obligations towards all its stakeholders.

However in Seoul (ILO 2008) and with the emergence of behaviour based safety (BBS) interventions as a management tool there was clearly a need to create a diagnostic tool that would allow companies to measure the success of their programmes while they are developing, not at the end by calculating the accident frequency rate and comparing it with pre-intervention levels. These kinds of measurements have traditionally been the favoured approach because they are considered tangible and anything associated with human behaviours such as BBS interventions are deemed intangible. The diagnosis of organisation cultural maturity described in McAleenan and McAleenan (2009) is a thorough examination of leadership roles, responsibilities and actions measured against the policies and practices within an organisation providing a tangible measure of what is normally considered to be the intangibles in the management system. This approach brings the focus onto the positive effects of both the tangible and intangible activities of an organisation and the measurement is in the form of a leading indicator, measuring successful interventions and activities as they occur.

LINKING OAC TO ORGANISATION CULTURAL MATURITY INDEX

At the 2008 World Congress in Seoul it was reiterated that safety and good health at

work is a fundamental human right enshrined in the United Nations Declaration on Human Rights (1948). The research at this stage brought into focus the early work on culture, leadership and the value of partnerships in delivering a successful and safe work outcome (Ayers and McAleenan 2008). The discourse is further advanced in the work of Behm et al (2009) where the discussion focuses on green and sustainable design, which has emerged from ethical considerations about what is good for the environment, and ultimately what is good for humanity. However when it comes to ethical design the values which guide the designer are founded in technical and engineering codes of practice and codes of conduct which appear fixed and stemming from higher professional authority rather than from an objective science. This research makes the case for the inclusion of a science of humanity in academic and professional studies as the foundation of the art and practice of ethical design (McAleenan and McAleenan 2009a, 2009b and 2010a). It is argued that only by understanding what human nature is and how we make determinations about what is good (and bad) for others and ourselves can we develop an ethical approach to what we design, build, maintain or operate. This hypothesis deepens our understanding of competence, culture and ultimately leadership in the delivery of a safe and healthy product or service.

As with good engineering or sustainable designs ethical design tends towards the construction of projects that are good for humanity in a holistic sense. Since the signing of the Seoul Declaration (2008) the research focus turned towards the emerging themes of competence (in its widest sense), culture, organisational maturity, governance and ethical responses. The objective being to explore range of techniques available to aid the development of competency within the company and in the process develop diagnostic tools to help build appropriate structures that meet the objectives of the Seoul Declaration (McAleenan and McAleenan 2009a). The research process used exemplar models, case studies, direct experience and innovative ideas that would allow practitioners to address workplace dynamics, their role within those dynamics and open a discussion of the options available to transform their company into one that advocates a competent and preventive culture (embedded throughout international declarations and protocols). Since good policy needs a clear definition of the problem(s) and a good explanation of how the policy will fix it then businesses need a diagnostic tool that will assist the process. All too often businesses jump straight to the remedy (e.g. behaviour-based safety [BBS] programmes) rather than getting to the root cause of their problem. Also with initiatives such as BBS the belief at the time was that many of the ensuing benefits were intangible and consequently not measurable, until some years down the line where a more tangible variable could be used to measure the success of the initiative. The result being the introduction of initiatives in hope that somewhere down the line success can be measured in, for example a reduced number of accidents. This focus in lagging and negative indicators betrays good strategic business practice and was the challenge of this research. The developed toolkit named, the Organisation Cultural Maturity Index (OCMI), derived from an earlier model⁴³ in operation across disciplines out-with the health and safety field.

⁴³ "Methodology for the Evaluation of Non-monetary Costs and Benefits in..." developed and used in a series of community audits in the 1990s to evaluate and appraise business management initiatives of a non-monetary nature that were ordinarily considered to be intangible. The approach complemented the UK Governments requirements for evaluating projects, defined in "THE GREEN BOOK - Appraisal and Evaluation in Central Government"

The OCMI diagnostic tool measures and presents in numerical terms both tangible and intangible performance indicators, allowing businesses to target improvement strategies that are appropriate for their strategic needs and are in line with their organisation's culture. In developing and implementing OAC processes within a company there are core maturity criteria, the absence of one or more could severely impair the company's sustainability and impact negatively on its ability to remain viable, relative to competitors in times of economic stability.

The maturity criteria are;

1. Corporate Social Responsibility (CSR): the competent company is aware of and acts to meet its responsibilities towards all the key stakeholders, including society, customers, community, workers and owners,
2. Innovation: the company is innovatory with the ability to diversify and transfer skills to the development of new products and outputs,
3. Resourcefulness: the company can use existing human, material and financial resources in a creative and adaptive manner to meet the challenges of changing social and economic conditions, and
4. Authority: the company encourages self-managing units in which individuals and teams have the authority to make decisions within the sphere of their control and influence.

If the culture of a company is deficient in or indeed missing one or more of these criteria it runs the risk of failing to compete in the market place against competitors who are stronger in these areas or leaves itself vulnerable to prosecution for breaches of statutory duty, closed out of markets for failure to innovate and, in respect of having 'too authoritarian an approach to management', is likely to fall foul of the declarations and conventions on safety and health at work.

Having selected the criteria the task was to design a way to objectively assess how a company demonstrates that it possesses the cultural attributes essential to successfully establishing preventive measures regarding occupational safety and health. The challenge is to put in place a system that will measure and monitor an organisation's behaviour and competence and present the findings in a consistently objective manner. Once the weighting of the maturity criteria have been established, when consistently applied year on year it objectively compares the growth in cultural maturity of the company. OCMI is designed to be able to deliver an in depth analysis by interrogating and measuring a range of verifiable sources including the policies and practices within a company; using direct observation, horizontal/ vertical slice interviews and desktop studies of relevant paperwork and assigns a range of scores to a number of capabilities, linked to the maturity criteria, which places the company on a maturity rating from 1–100% (Table 1).

Table 1: OCMI - Cultural Maturity Rating (Example)

Company Name:		Company Contact Details:					
		Maturity criteria for a competent company					
Core Capabilities (In respect of Safety Culture)	CSR	Innovation	Resource-fulness	Authority	Score Average	Weighted multiplier	Multiplied score
Leadership	6	8	4	-1	4.25	10	42.5
Collaborative Working	3	6	5	9	5.75	5	28.75
Working Safely	6	3	2	8	4.75	10	47.5
Using Management Standards	5	6	7	8	6.5	5	32.5
Developing People	8	7	6	5	6.5	8	52
Managing Operations, Project Controls	3	2	8	8	5.25	5	26.25
Reporting Effectively	6	7	8	5	6.5	10	65
Incentivising Behaviour	7	3	2	8	5	5	25
Defining Objectives	8	6	7	8	7.25	8	58
Setting & Managing Budgets, Establishing human/material/financial resources	5	7	6	5	5.75	5	28.75
					Totals	71	406.25
					Maturity Rating	57.22 %	

Assigning the scores is based on the assessor's objective determination of the evidence gathered relating to the knowledge held by the company its ability to act on it in the management of the operation. The assessor's determination must be reasonable and in line with what another person competent to conduct such an analysis would make; i.e. the judgement of the evidence and the scores assigned must not be perverse. The assessor is guided by standard audit protocol. This ensures the objectivity of the process and permits independent verification of the evidence and scoring. Table 2 illustrates the scoring range.

Table 2: OCMI Scoring Range

Basis for scoring	No evidence	Awareness	Knowledge	Understanding	Ability-competent to act	Ability – competent to manage
Scoring Range	-1	1-2	3-4	5-6	7-8	9-10

No Evidence, where no evidence is produced or the evidence produced is insufficient or unsuitable the score assigned is -1. There is no need for a range of negative scores as absence is an absolute in the context of this assessment.

Awareness, individuals and teams, the department or the company demonstrate awareness of policies and procedures or of the primary indicators pertaining to the core capabilities but have not been able to demonstrate knowledge of the content or detail.

Score 1-2

Knowledge, the content and detail of the primary indicators are adequately known to a sufficient number of managers and workers such that they can carry out their functions or follow the guidance contained within them.

Score 3-4

Understanding, a sufficient number of managers and workers demonstrated an understanding of the purposes and requirements of the policies or of the how and what of their work activities such that they can explain them to another.

Score 5-6

Ability – competent to act, a level of understanding has been achieved such that a sufficient number of managers and workers can carry out their work activities safely and unsupervised. They are capable of anticipating and reacting to variations in the work conditions.

Score 7-8

Ability – competent to manage, a level of ability such that they can consistently manage the processes at work, and others, are capable of interpreting the requests from above, determining the requirements for and authorised to obtain the resources and direct work operations.

Score 9-10

OCMI was piloted in a UK consulting firm and has been scrutinised by a number of key players in Canadian oil and gas industry and is considered to be the right tool coming at the right time for industry. The pilot study, among other findings, allayed concerns regarding the integration of OCMI into existing company safety approaches, such as perception surveys, climates studies.

Additional findings derived the following:

- The knowledge gained would supplement or augment company activity to help advance safety performance improvements. By creating a baseline for improvement and putting a tangible rating to an otherwise intangible activity adds value to the safety management system.

- Through an examination of the material facts and a critique of the consequences of what interview respondents say (or don't say) can establish whether the talent in the company is in the appropriate position and the degree of effort needed to deliver the company safety vision and whether there is duplication, conflict or contradiction of effort.
- The analysis gets to the root cause of problems and identifies how attitudes, behaviours and how the job might need to change so the company retains its legal obligations and safety vision (by departmental or across the whole company).

The pilot company owner followed up the diagnosis with the following statement:

“Whilst striving hard to meet shareholder and stakeholder needs, approaching this ethically and with full support of my team is vitally important. [Auditors] conducted an organisationally centred study using OCMI, which proved to be a real eye opener. Its primary strength is to create a clear view of reality, from multiple perspectives enabling contemporary managers to make informed decisions on every facet of their business...”

CONCLUSION

As the workers become more aware of, move toward greater understanding of and ultimately take control of their decision making; a raising of consciousness, then power becomes more evenly distributed. The employer/ employee; tell/ do attitudes can be eradicated from the world of work, replaced by a more socially aware and responsible organisation; the essence of cultural maturity. The next step in the development of workplace cultural maturity centres not solely on whether a worker goes home as safely and as healthfully as he arrived that morning, but on how the culture of the workplace contributes to the overall benefit of society. OCMI effectively closed the circle of development of the new occupational safety and health management model; a tool now existed that could diagnose the problems (OCMI) and a tool exists that can deliver the necessary transformation (OAC).

The research has demonstrated that it is possible to develop a diagnostic tool that analyses the apparently immeasurable intangibles of organisational culture to produce tangible and significant performance improvement solutions in a safe and sustainable manner. As a result of the pilot project and recent research on ethics reasoning and agency there is a need for refinement to the OCMI diagnostic tool. The current research (OCMI Iteration 2) is revising the maturity criteria to focus on ethics reasoning, agency, personnel competence and sustainability. Consequently the continuing efficacy of the core capabilities will be subject to review using the praxis tool and modified as necessary to reflect the revisions to the model.

REFERENCES

- Ayers, G. and McAleenan, C. (2008) Encouraging meaningful and effective consultation about occupational health and safety (OHS) in the construction industry: a recognition of workforce competence. Seoul: World Congress on Safety and Health Proceedings
- Behm, M., Lentz, T., Heidel, D. and Gambatese, J (2009) "Prevention Through Design and Green Buildings: a US Perspective on Collaboration" Proceedings of the 2009 CIB W099 Conference, November 2009, Melbourne Australia
- Crosby, P. B. (1979) *Quality is Free: The Art of Making Quality Certain*. New York: McGraw-Hill
- Deming, W.E. (1986) *Out of the Crisis*. Cambridge MA: MIT Press
- Egan, J. (1998) *Rethinking Construction. The Report of the Construction Task Force*. HMSO. London
- Flechler, K. (2011) *Pursuing Zero by Building a safety Leadership Culture*. World Congress on Safety and Health, Istanbul, Turkey. Istanbul: CSGB
- Fromm, E. (1947). *Man for Himself*. Routledge, Oxon, 2003
- International Labour Office (2001) *Guidelines on occupational safety and health management systems (ILO OSH 2001)*. Geneva: ILO
- International Labour Office (2002) *Recording and notification of occupational accidents and diseases and ILO list of occupational diseases" 90th Session, Geneva, June 2002* [Online] <http://www.ilo.org/public/english/standards/reln/ilc/ilc90/rep-v-1.htm#Q1> [Accessed 3rd February 2014]
- International Labour Office (2011) *World Statistic" [Online]* <http://www.ilo.org/public/english/region/eurpro/moscow/areas/safety/statistic.htm> [Accessed 3rd February 2014]
- International Labour Organisation, International Social Security Association and Korean Occupational Safety and Health Agency (2008) "Seoul Declaration on Safety and Health at Work" adopted at the 18th World Congress on Safety and Health at Work, June 2008, Seoul Korea
- Juran, J.M and Godfrey, A.B. (1998) *Juran's Quality Handbook, 5th edition*. New York: McGraw-Hill
- Löwy, M. (2011) *The Spark Ignites in the Action – the Philosophy of Praxis in the Thought of Rosa Luxemburg*. International Viewpoint IV436: Forth International
- McAleenan, C. and Orr, D. (1999) *Safety - Turning the Event into a Process*. London: Submitted to Institution of Civil Engineers.
- McAleenan, P. and McAleenan, C. (2002) *A Different Approach – Operational Analysis and Control"*, Chicago: National Safety Congress' [San Diego] Professional Development Conference Proceedings
- McAleenan, P. and McAleenan, C. (2009a) *Development of the Competent Company in the Context of the Seoul Declaration*. Toronto: CSSE [Calgary] Professional Development Conference Proceedings
- McAleenan, C. and McAleenan, P. (2009b) *An Exploration of Structured and Flexible Approaches to Recognising Engineering Competence*. Melbourne: RMIT CIB W099 Conference Proceedings

- McAleenan, C. and McAleenan, P. (2010a) An Exploration of Structured and Flexible Approaches to Developing OSH Competence in Engineering. Belfast: University of Ulster AISBEE Conference Proceedings
- McAleenan, P. and McAleenan, C, (2010b) "Calculating your Flight Distance - the Evolution of Safety in the Competent Company" Proceedings of the 2010 sitting of the Canadian Society of safety Engineering Professional Development Conference, September 2010, Halifax Canada
- Robens of Woldingham Alfred Robens Baron., (1972) "Safety and health at Work. Report of the Committee 1970-72" (Cmnd. 5034), London: HMSO
- United Nations. (1948) Universal Declaration on Human Rights. Paris: UN General Assembly
- Works and Pensions Committee (2008). Minutes of Evidence taken before the Work and Pensions Committee, UK Government [online]
<http://www.publications.parliament.uk/pa/cm200708/cmselect/cmworpen/uc246-iii/uc24602.htm>) [Accessed 3rd February 2014]

A STUDY OF THE PROACTIVE OCCUPATIONAL SAFETY AND HEALTH WORK IN A SWEDISH CONSTRUCTION COMPANY – THE EXAMPLE OF VIBRATION EXPOSURE

Åsa Ek⁴⁴ and Petra Andersson¹

¹ *Department of Design Sciences, Ergonomics and Aerosol Technology, Faculty of Engineering, Lund University, PO Box 118, SE-221 00 Lund, Sweden, and*

Lund University Centre for Medicine and Technology for Working Life and Society (METALUND)

Exposure to vibrations from tools and machines used in construction work can induce damages to the human body. One of the most frequent symptoms is the hand-arm vibration syndrome commonly known as white fingers. The proportions of the international workforce exposed to vibrations are high and dominating sectors are construction, agriculture, forestry, and transport. Particularly exposed construction occupational groups include machine operators and drivers of vehicles. In 2005, the Swedish Work Environment Authority introduced a new guideline on the topic of preventing vibration exposure risks (AFS 2005:15) based on the European union 2002/44/EC directive on workers' exposure to vibration. It includes raised demands on estimating vibration exposure, and clearly stated responsibilities and rights of employers and employees. However, in 2011 the Swedish Work Environment Authority's inspections showed that many employers belonging to sectors such as building and construction, transport, and mining industry did not have any satisfactory proactive risk management work concerning vibration exposure. This paper reports on a pilot study performed in a large Swedish construction company with the aim to yield more knowledge about factors affecting the implementation of the guidelines and to suggest actions for improvement. A total of 31 construction workers and supervisors were interviewed at nine construction sites in southern Sweden. Interview results demonstrated a lack of knowledge in estimating vibration exposure; the incorporation of the Work Environment Authority's directions had not been accomplished; driving forces for improving the proactive health and safety work and specifically vibration exposure management was weak on all organisational levels; important factors affecting the implementation of vibration exposure regulations are the psychosocial work environment at construction sites as well as company safety culture; a large proportion of the interviewed construction workers was judged to be at risk for developing vibration injuries if the exposure was not decreased; management, supervisory, and production levels need increased knowledge about vibration exposure and vibration injuries; and methods and tools for easy estimation of vibration exposure needs to be developed.

Keywords: hand-arm vibration syndrome, health and safety management, proactivity.

INTRODUCTION

Exposure to vibrations from tools and machines used in construction work can induce damages to the human body. Exposure to vibrations can lead to physical complaints in different ways. Vibrations are classified as either hand-arm vibrations or whole body vibrations. Exposure to these types of vibrations can pose substantial risks to worker's

¹ asa.ek@design.lth.se

health (VIBRISKS 2007). When using handheld machines that vibrates oscillations are transmitted to arms and hands which can cause temporary or permanent injury (Hagberg 2002; Swedish Work Environment Authority 2005; Griffin et al. 2006). Injuries can arise on nerves, blood-vessels, joints, and muscles. One of the most frequent symptoms is the hand-arm vibration syndrome commonly known as white fingers. This syndrome generally involves whitened extremities, pain in arms and fingers and degradation in mobility and function when it comes to finer motor ability.

Hand-arm vibrations can also cause temporary musculoskeletal disorders (Refisch & Wålinder 2009; Griffin 1990). These disorders are difficult to derive from vibrations alone as they very probably are linked to other ergonomic risk factors.

A human being is exposed to whole body vibrations when standing on, sitting down on or leaning against a vibrating surface (Paschold 2008). When the human body is exposed to external vibrations these vibrations can cause resonance with the body's own vibrations leading to amplified oscillations in various body parts and organs.

The European Agency for Safety and Health at Work (2008) report that workers exposed to vibrations are overwhelmingly male and typically either drivers of mobile machines, operators of hand-tools, or people working in the vicinity of stationary machines. The proportion of the workforce exposed to vibration varies widely between European countries, from 14 % to 34 %, and is concentrated in the sectors of construction (63 %), manufacture and mining (44 %) and agriculture and fishing (38 %). Among Australian workers approximately 24% are exposed to vibration in their workplace and the industries with the highest likelihood of exposure to vibration are construction, agriculture, forestry and fishing as well as transport and storage (Safe Work Australia 2009). In the US it is estimated that 8-10 million people are regularly exposed to occupational vibration. In Sweden, the second most common occupational disease among males is vibration injuries (17 %). It is concentrated to the manufacturing and construction industries. The injuries affect all ages and as much as 30 % is below 45 years of age (Larsson, Normark, Paulsson & Åkerström 2013).

Particularly exposed occupational groups include machine operators and drivers of vehicles: groups that are present at most construction sites during the whole construction period. Vibrations can impair driver attention, cause drowsiness, as well as intrude on body movements. During heavy exposure the driver can experience physical and mental exhaustion as well as decreased performance. One of the most frequent vibration induced injury among construction workers are pain in the lower parts of the back (Paschold 2008).

In 2005, the Swedish Work Environment Authority introduced a new guideline on the topic of preventing vibration exposure risks (AFS 2005:15). The guideline is based on the European union 2002/44/EC directive on workers' exposure to vibration. The guideline includes raised demands on estimating vibration exposure, and clearly stated responsibilities and rights of employers and employees. Employers must plan, operate, and follow-up the work so that the risks for exposure for vibrations are minimized. Risk assessments should be conducted by the employer regularly, be revised and be documented. The regulation also sets action values and limit values for vibration exposure. When exposure action values are exceeded the employer is obliged to offer medical check-ups to employees and to review the workplace concerning vibration exposure. However, the employee may refrain from taking part in the medical check-

ups. When exposure limit values are exceeded the employer have to take measures in order to reduce the exposure at the workplace.

In order to live up to the AFS 2005:15 the employer must estimate daily vibration exposure at the workplace and assess if it is unhealthy or not. The Swedish Work Environment Authority offers a specific method or tool which enables a simple estimation of daily vibration exposure. The method can be used both concerning hand-arm as well as whole body vibrations.

However, in 2011 the Swedish Work Environment Authority's inspections showed that seven out of ten employers did not have any satisfactory proactive risk management work concerning vibration exposure. The employers belonged to sectors such as building and construction, transport, and mining industry. Also, despite the new guidelines, the number of construction workers reporting occupational injuries due to exposure to vibrations has not decreased. Instead, the number of workers in Sweden exposed to whole body vibrations increased with 15 % from 1997 to 2009 (Karolinska Institutet 2009). The dominating industry is construction.

Aim of the paper

This paper reports on a pilot study performed in a major construction company in Sweden with the aim to yield more knowledge about factors affecting the implementation of the guidelines on vibration exposure. Through interviews at construction sites the aim was to get insight on the extent of vibration exposure, the awareness and knowledge about vibration injuries, conducted risk assessments and possibilities for improvements within the company regarding the occupational safety and health work and specifically concerning vibration exposure.

METHODS AND MATERIAL

Interviews were conducted in a major construction company in Sweden in order to get insight in the proactive risk management concerning work tasks where exposure for vibrations occur. In total, 10 site supervisors and 21 construction workers (including safety officers) were interviewed. All interviewees were men, between 22-61 years of age with an average age of 39 years (Table 1).

Table 1: Distribution of age groups among the 21 interviewed construction workers.

Age (years)	16-24	25-34	35-44	45-54	55-59	60-
	2	8	4	5		2

The interviews were conducted at nine construction sites of civil works in southern Sweden. The sites had one supervisor and at least two construction workers working there daily. The interviews were conducted during March - April 2012.

The interviews focused on: the existing routines at the work site when working with vibrating machines and equipment; the extent of vibration exposure: how many work hours per week with exposure? and is deliberate pauses taken during work with vibration exposure?; the interviewees awareness and knowledge about vibration exposure and consequences on the human body; the risks in daily work and if the risk assessment of vibration exposure and following measures reflected the demands from the Work Environment Authority; and possibilities for improvements within the

company regarding the occupational safety and health work and specifically concerning vibration exposure.

RESULTS

Interviews were conducted at nine construction sites in southern Sweden and with a total of 10 site supervisors and 21 construction workers.

Estimation of vibration exposure at the construction sites

All 10 site supervisors answered that estimation of daily vibration exposures were not performed at the work sites. Even in those cases when vibrations had been noted as a risk in the project risk inventory no actual estimation of the extent of the exposures had been made. They were aware of the Work Environment Authority's regulations and knew where to search in order to find guidelines concerning the estimation of exposures. The site supervisors had not offered medical check-ups to employees in suspected cases of too high vibration exposure. In those cases when contacts concerning medical check-ups had been taken, these contacts had been made on the employees own initiative.

A tool for estimating daily vibration exposure is provided by the Work Environment Authority. The interviews showed that the site supervisors did not know about it, nor had they used alternative tools for estimating vibration exposure.

Vibrating tools and machines at the work sites

Several of the construction workers had used tools and machines with lower vibration levels than other equivalent machines. The same workers experienced that this equipment was much less effective compared to the other equipment. In several cases, after trying out the equipment with lower vibration levels and presenting complaints to the supervisory level, it had resulted in that the machine was sent back to the supplier in exchange of a more powerful and effective machine (which also had higher vibration levels). Several supervisors had similar experiences. When trying to take in machines recommended by the manufacturers or suppliers for their low vibration levels these machines were sent back due to complaints from the workforce. The interviewees' highlighted increased time pressures (which many experience in building projects today) resulting in the use of machines that are as efficient as possible. The risks for vibration injuries were not as known or evident. Also, the interviewer noted how little the machines had developed and changed in design the last five years.

Physical complaints among interviewees

Concerning the existence of physical complaints among interviewees three groups could be discerned.

Of the 21 construction workers four stated suffering from or having suffered from vibration injuries (19 %). Eleven of the 21 (52 %) stated having physical complaints judged to be in the area of vibration injuries, i.e. they either showed symptoms of vibration injuries even if they themselves did not judge them as vibration injuries, or they were at risk of developing vibration injuries in the future due to existing physical complaints.

Six of the 21 (29 %) interviewed construction workers had no physical complaints related to vibration injuries. Of these there were also individuals that did not know of anyone being affected by vibration injuries.

That majority of the interviewees that described short-term complaints from working with vibrating equipment, did not consider the complaints as injuries. To feel discomfort in arms and hands several days after a completed work task or during a time period having the need for "shaking down the blood to the fingers" was taken with a shrug.

Perceived vibration exposure at the work sites

The interviewees were asked to try to estimate how many hours per working-week they were working with vibrating machines and tools. The average estimated exposure for the three groups is presented in Figure 1. The interviews clearly show that an increased vibration exposure was related to the group of employees with most physical complaints. Those who did not experience any complaints were much less exposed than those diagnosed with a vibration injury. Those diagnosed for vibration injuries were not exposed to vibrations as much as those experiencing physical complaints with suspected vibration symptoms. Interviewees with vibration injuries (white fingers, problems with fine motor abilities) worked overall about three hours per day with vibrating equipment, while those not suffering from any complaints worked two hours per day overall.

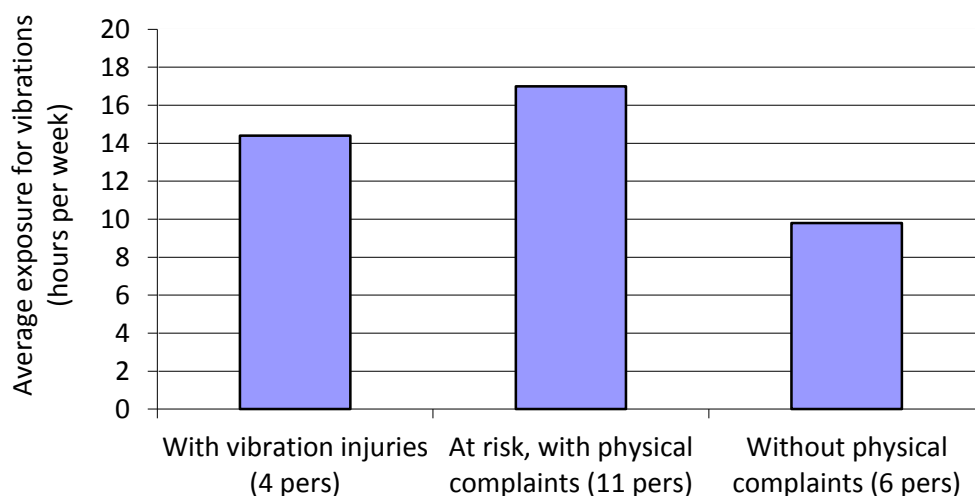

Figure 1: Average estimated exposure for vibrations (hours per week) for the three groups of construction workers (40 hour work-week).

The Work Environment Authority recommends work rotation as a measure to reduce exposure to vibrations as well as taking pauses during work with vibrating equipment. Interview results show that deliberate pauses were taken to a relatively small extent (Figure 2). More than 60 % of all interviewees did not take deliberate pauses while working with vibrating equipment. "You carry on until the work is finished, or until the body says stop. With the years you have learned to listen to your body".

Three of the four interviewees suffering from vibration injuries took deliberate pauses when using vibrating machines during their daily work. Those who took deliberate pauses to least extent belonged to the group being at risk for vibration injuries: less

than one third of them took deliberate pauses. For individuals with no physical complaints, the number taking deliberate pauses were somewhat higher.

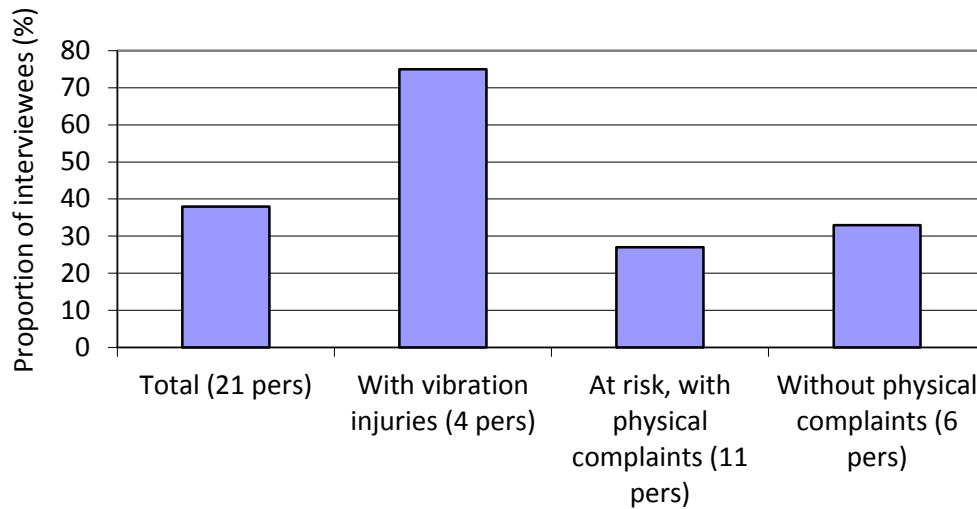

Figure 2: Proportion of the construction workers taking deliberate pauses while working with vibrating equipment, in total and for the three groups of construction workers.

Knowledge about vibration injuries

One part of the interview focused on how well site supervisors and construction workers knew about the consequences of vibration exposure. The symptoms that the interviewees knew best were white fingers and injuries on joints and muscles.

Nine of the 31 interviewees were judged to have inadequate knowledge about vibration injuries. They could come up with only one possible consequence of over exposure of vibrations; either white fingers or problems with the balance while running machines.

Almost half of the interviewees (14/31) perceived that the topic of vibration exposure was not discussed at the workplaces of the construction company. In some cases, it was perceived that the topic was discussed only when particular machines were to be used or when unusual work operations were going to take place.

Measures taken to reduce vibration exposure

Half of the interviewees perceived that the construction company had taken measures to reduce vibration exposure. The most common measures were to ensure the use of new and well-functioning machines, to use alternative work methods and to equip workers with vibration reducing gloves.

In general, the following measures had been taken at the work places: use of vibration reducing gloves; old machines changed to new ones; alternative work methods if unusual work operations; good quality of machines and appliances; work rotation when long work operations; and remote-controlled machines.

Possibilities for improvement

The site supervisors and construction workers saw several possibilities for improvements within the company regarding the occupational safety and health work and specifically concerning vibration exposure.

- Site supervisors as well as machine suppliers should ensure the use of new equipment with good quality
- Exposure for vibrations should be highlighted in the project risk inventory
- Develop simple and user-friendly methods for estimating vibration exposure
- At a new construction site as well as when new staff is added you should review the equipment and how it should be used
- Clear instructions should accompany the equipment from the supplier
- Machines should be marked with action values and limit values for vibration exposure (expressed in minutes)
- Increased education concerning injuries from vibration exposure
- Suppliers and salesmen of equipment could demonstrate new potential machines directly at the construction site
- Improve the design of machines and equipment
- The employer should inform about the risks and encourage discussions at the workplaces
- Maintain work rotation and do follow-ups
- Alternative low vibrating equipment should be considered more often.

DISCUSSION

This pilot study gave insight in how the risks for vibration injuries was perceived by site supervisors and construction workers. The conclusions drawn by the Work Environment Authority in their inspections from 2011 is also valid for the studied construction company where the management of vibration exposures can be considerably improved. Regular estimations of daily vibration exposures were not performed at the work places, and recommended tools from the Work Environment Authority for these estimations were not known by site supervisors.

Interviewed construction workers could be divided into three groups concerning existing physical complaints: without complaints; at risk; with vibration injuries. The group 'at risk' (11/21) had the highest exposure of daily vibrations (up to 17 hours per week). This group also took deliberate pauses to the least extent. A warning sign in this group is the group members risk perception or lack of risk perception. Several workers showed clear examples of vibration injuries, but they were not perceived as actual problems where to expect solutions or improvements. The injuries were perceived as normal consequences for all who work in construction and in contact with vibrating tools.

The reasons why the vibration exposure regulations have not been incorporated into the construction company and industry routines may be due to they not being communicated in a comprehensive way by the Authority or have not been prioritized by the receiver. Another important factor to why the construction industry have difficulty to apply the regulations are the psychosocial work environment as well as the prevailing safety culture among construction workers and on other organisational levels in a construction company.

Driving forces to improved proactive health and safety work

The driving forces among authorities, European as well as Swedish, to reduce the number of occupational injuries such as vibration injuries led to the introduction of the new regulations in 2005. This measure has then been followed-up by the Authority's

inspections which showed that the construction industry was not applying the regulations. The motivation to develop a proactive health and safety work seems to have got stuck on its way through the construction companies' organisations.

In the current case, the interviews indicated that the motivation to strengthen the proactive work concerning vibration injuries was low at management level within the company. The managements driving forces for highlighting vibration injuries were weak. The company have had no 'campaigns' for increased information or drive at improved risk management of vibration injuries. The results show that the problem have been carried over to initiatives on production level instead of finding solutions and handling the problem on higher decision-making levels in the organisation. In order to increase the driving forces on this higher-levels extensive commitment to reduce vibration exposures is needed in the major construction company if not in the entire construction industry. In the case of falls from height and work at height which is more considered and respected today by construction workers and sweepers you can suspect that the Authorities actions and fines have played a crucial role for increasing the driving forces within small or large construction companies.

The work force in the studied construction company was not motivated enough to change their behaviour pattern: vibrations were not seen as a threat. Compared to the other physical risks that the construction work is associated with the risk for vibration injuries is less known, not as serious or immediate. There are many work operations where the risk of injury is more direct, visible and more common. For example, falls from height, handling knives and saws, and manual handling of loads. An injury that are more direct gets more attention compared to injuries that more discreetly sneak up on you over time which is often the case with vibration injuries.

Safety culture in construction

The construction industry has for a long time been demographically homogeneous and static: above all the work force is male-dominated with low diversity. Also, the members of the work force are often isolated from other activities in a construction project contributing to the internal strength of the specific workgroups. The strong group membership and the distinct hierarchies on, above all, work force level make it difficult to change the safety culture within a construction company.

A construction project involves many different competencies that not necessarily can cover for each other. Every co-worker is a specialist in his/her field: a machine operator can not do the job of a construction worker and vice versa. Therefore, it can be difficult to introduce changes at the work place if the changes only concerns one group category.

The site supervisor may not have the same understanding for or practical work knowledge as the construction workers if the supervisor has made a career from another group category. Therefore, the site supervisor may experience difficulties in changing the behaviours in a group as the supervisor in some way do not belong to the group.

The many groups of specialists at a construction site can make it difficult to give criticism as well as introducing common frameworks concerning the work environment and routines.

Furthermore, an important effect on the safety culture in construction is the attitude towards physical injuries - that some injuries naturally comes with the work. It is

strenuous with physical work and many of your colleagues have suffered physical complaints during the working life. There seems to exist a general acceptance of injuries- it is more normal to suffer from a physical complaint than not.

There is a need for a change in construction workers attitudes that long-term injuries do not need as much as attention as short-term injuries. The studied construction company had a zero vision concerning injuries at their workplaces. The vision concerned both short-term and long-term injuries. This means that the long-term injuries need to be prevented even if they on the surface have a seemingly less effect on the daily work.

Improving the management of vibration exposure

A construction company and other actors in the industry could with rather simple means and measures improve the management of work with vibration exposure. Some of the interviewees many reflections and suggestions for improvements are given in the results section. Measures that have the potential to improve the management of vibration exposure is to design user-friendly methods and systems for estimating daily vibration exposure and to raise awareness among workers at the work sites by giving clearer risk information about the machines and equipment used in daily work. In order to increase knowledge and awareness among employees about vibration injuries and change attitudes that negatively affect health and safety at work an educational program with focus on vibration exposure is suggested. All organisational levels of a construction company are to take part. The knowledge and attitudes to risk and safety on top management levels in a company (and in any industry) are extremely important for creating positive safety attitudes and good safety behaviours among the workforce of the company.

In order to reduce occupational exposure to hand-transmitted vibration several types of vibration reducing gloves have been developed. A few studies have reported that some of these gloves could be helpful (e.g. Mahbub et al. 2007), but other studies show their effectiveness remains unclear, especially for finger protection (Welcome et al. 2014). Vibration reducing gloves may be uncomfortable to wear and cause hand fatigue (Welcome et al. 2014) and can reduce finger dexterity and increase handgrip effort (Wimer et al. 2010). It has been shown that the vibration isolation performance of gloves is tool- and operation-specific. However, the effectiveness of gloves when used with specific vibratory tools has not been well studied (Dong et al. 2003). This is often due to the challenging task of objectively measuring hand-arm vibrations at work: exposure depends on the circumstances in which a task is executed; the tools used; the material being processed; and individual worker's characteristics (Coenen et al. 2014).

The research method applied in the pilot study

This pilot study was based on information gained through interviews with 10 supervisors and 21 construction workers at nine construction sites in southern Sweden. The research material was too small in order to draw any far-reaching conclusions. The interviewees were asked to estimate how long (hours per week) they worked with tools and machines that vibrate. Their answers may not reveal actual working hours but instead the duration of time needed to complete a work task where work with vibrating equipment is included. It was beyond the scope of the study to obtain measured exposures to vibration and it was therefore impossible to determine whether or not the reported vibration exposures were hazardous. However, the part of the

interview focusing on organisational aspects of vibration exposure, such as routines for risk assessments, risk awareness and knowledge about health consequences, and measures taken to reduce vibration exposure are believed to have yielded reliable results.

CONCLUSIONS

The following conclusion from the pilot study can be drawn:

- The Swedish Work Environment Authority's regulation on vibration exposure is not satisfactorily acted on in the construction industry.
- Estimations of daily vibration exposure is not performed at the work sites.
- Driving forces for improving the proactive health and safety work and specifically vibration exposure management is weak on all organisational levels.
- Important factors affecting the implementation of vibration exposure regulations are the psychosocial work environment at construction sites as well as company safety culture.
- A large proportion of the interviewed construction workers is judged to be at risk for developing vibration injuries if the exposure is not decreased.
- Management, supervisory, and production levels need increased knowledge about vibration exposure and vibration injuries.
- Methods and tools for easy estimation of vibration exposure need to be developed.

REFERENCES

- Coenen, P, Formanoy, M, Douwes, M, Bosch, T and de Kraker, H (2014) Validity and inter-observer reliability of subjective hand-arm vibration assessments. "Applied Ergonomics", 45, 1257-1262.
- Dong, R G, McDowell, T W, Welcome, D E, Smutz, W P, Schopper, A W, Warren, C, Wu J Z and Rakheja, S (2003) On-the-hand measurement methods for assessing effectiveness of anti-vibration gloves. "International Journal of Industrial Ergonomics", 32, 283-298.
- European Agency for Safety and Health at Work (2008) "Workplace exposure to vibration in Europe: an expert review". Luxembourg: Office for Official Publications of the European Communities.
- Griffin, M J (1990) "Handbook of human vibration". Sidney: Academic Press.
- Griffin, M J, Howarth, H V C, Pitts, P M, Fischer, S, Kaulbars, U, Donati, P M and Bereton P F (2008) "Non binding guide to good practice for implementing Directive 2002/44/EC (Vibrations at Work)". European Communities, Brussels, Belgium.
- Hagberg, M (2002) Clinical assessment of musculoskeletal disorders in workers exposed to hand-arm vibration. "International Archive of Occupational Environment and Health", 75, 97-105.
- Karolinska Institutet (2009) "Whole-body vibrations". Stockholm: Karolinska Institutet. (In Swedish)
- Larsson, T J, Normark, M, Paulsson, P A and Åkerström, T (2013) "Occupational injury report: Serious injuries and long-term sick leave". AFA Insurance. (In Swedish)

- Mahbub, H, Yokoyama, K, Laskar, S, Inoue, M, Takahashi, Y, Yamamoto, S (2007) Assessing the influence of antivibration glove on digital vascular responses to acute hand-arm vibration. "Journal of Occupational Health", 49(3), 165-171.
- Paschold, H W (2008) Whole-body vibrations. "Professional Safety", 53(6), 52-57.
- Refisch, S and Wålinder, R (2009) ABC about vibration injuries. "Läkartidningen", 106(9), 439-442.
- Safe Work Australia (2009) "National hazard exposure worker surveillance - Vibration exposure and the provision of vibration control measures in Australian workplaces". Commonwealth of Australia.
- Swedish Work Environment Authority (2005) AFS 2005:15. "Vibrations". Solna. (In Swedish)
- VIBRISKS (2007) "Risks of occupational vibration exposures: Final technical report". FP5 Project No. QLK4-2002-02650.
<http://www.vibrisks.soton.ac.uk/reports/VIBRISKS%20Final%20Technical%20Report%20210907.pdf>
- Welcome, D E, Dong, R G, Xu, X S, Warren, C and McDowell, T W (2014) The effects of vibration-reducing gloves on finger vibration. "International Journal of Industrial Ergonomics", 44, 45-59.
- Wimer, B M, McDowell, T W, Xu, X S, Welcome, D E, Warren, C and Dong, R G (2010) Effects of gloves on the total grip strength applied to cylindrical handles. "International Journal of Industrial Ergonomics", 40(5), 574-583.

TEMPORARY WORKS ACCIDENTS: AN INVESTIGATION OF THE ROLE OF THE TEMPORARY WORKS COORDINATOR IN THE UK.

S.C. Williams⁴⁵, A.G.F Gibb² and P.D. Bust²

¹Faithful + Gould, The Hub, 500 Aztec West, Bristol, UK (was Loughborough University)

²School of Civil and Building Engineering, Loughborough University, Leicestershire, UK

Construction is an inherently dangerous industry, with a significant number of UK accidents associated with temporary works (TW). In the UK the role of the Temporary Works Coordinator (TWC) was introduced following some major temporary works (TW) failures in the 1970s. The role of the TWC has been criticised and UK contractors have investigated whether guidelines for or competence of the TWC need to be improved. A study was carried out to look at the role of the TWC in the UK which included a review of current literature and the elicitation of information from industry professionals using interviews and questionnaires. This was an extension of an undergraduate student final year dissertation and is important because of a lack of existing research in this area. The work underlines the need for further investigation into inconsistencies and lack of understanding of existing guidance and while it was found that TWCs were selected in accordance with current regulations in the UK there was inconsistency in their preferred attributes and training backgrounds.

Keywords: Temporary works, accidents, supervision, competence.

INTRODUCTION

The regulation of Temporary Works (TW) before 1970 in the UK was very limited but this changed as a result of the collapse of the Lodden Bridge during construction on the 24th October in 1972. A UK Government working party was set up to investigate the incident which recommended that a committee be appointed to advise the secretaries of state for both Environment and Employment. The committee chaired by Stephen Bragg, produced the Bragg Report (Bragg, 1976). The report recommended the introduction of a falsework coordinator; (later broadened to TWC) to be responsible for checking the safety of TW at various stages including procurement, design and construction (HSE 2001). It took until 1982 for the Bragg report recommendations to emerge as BS5975 which detailed the management, design and supervision of falsework; in 2008 it was revised to encompass a variety of TW, becoming the principal source of guidance available to TWCs.

Temporary works (TW) occur on nearly every construction site. Regulations and guidelines exist for those in charge of ensuring the safety of the workers, the public and property. However, from previous research (Williams et al., 2012; SCOSS, 2010; Cameron 2011) it was considered that the regulation was not stringent enough and as a

⁴⁵ Sarah.williams@fgould.com

consequence TW accidents were still common. TW accidents often result in fatalities or major injuries. However, there is no TW category in The UK statutory instrument for Reporting of Injuries, Diseases and Dangerous Occurrences Regulations (RIDDOR) which masks the true nature of the problem as these accidents are often misclassified. For example, TW can be separated into access TW (e.g. scaffolding) or support TW (e.g. formwork & falsework). If a scaffolding accident is reported it is likely to be categorised as a fall from height yet a the best classification of a formwork/falsework accident would be a slope movement failure under RIDDOR.

Current UK legislation (BS5975 and the Health and Safety at Work Act) require the appointment of a TWC whose main role is to oversee and manage all TW on site. However, it does not have to be their sole role and on smaller sites the TWC may also be the site agent or foreman. With no single definition for TW and the broad variety of TW available this is particularly challenging and questions the specific knowledge a TWC should possess. Gilbertson et al (2011) noted that often the role of the TWC was simply tacked on to current duties. On larger complex sites it is likely one or more temporary works supervisors (TWS) will be employed to assist the TWC, but ultimate responsibility is still with the TWC.

Subsequent research raised criticism about the competency of those employed in the role. These concerns led to an investigation, by a number of large contracting firms, about the availability of current industry guidelines, private support and training. It also looked at whether improved guidelines or stricter control on TWCs selection could lead to a reduction in TW accidents.

METHODS

The research involved:

A review of the literature associated with accidents, and the guidelines available to temporary works coordinators. Due to a scarcity of research papers on construction health and safety and TW the review extended to cover trade magazines and websites that generally reported on TW accidents where fatalities had occurred.

Interviews were used to establish how TWC are appointed and the support available to TWC in terms of training and industry guidelines. Four TWCs from Principal UK Contractors which collectively represented 25% of the top 100 industry annual turnover and a representative from the Temporary Works forum (TWf) (a UK industry wide interest group - made up of 'an interested and concerned group of senior and experienced engineers and managers').

A questionnaire was developed to ascertain current industry perceptions of the role and competence of the TWC. This was distributed via LinkedIn Polls on the Institution of Civil Engineers group - 'Industry Questionnaire'. The questionnaire was also sent to members of the TWf.

FINDINGS

Literature review

Temporary Works Definition

No single definition for TW exists, however Illingworth (1987) defines them as 'temporary structures that allow permanent works to be constructed' (Table 1):

Table 1: The General Scope of TW on site (Illingworth, 2000)

Reason for need	TW items involved
The site and its boundaries	Provision of temporary access – roads, bridges, temporary support to adjacent buildings – shoring and waterproofing. Protective measures when plant required to travel under HT lines or work adjacent. Protection of the public adjacent to the works or where rights of way have to be maintained on the site. Safety measures when working adjacent to railways. Hoardings and fencing – traffic management needs.
TW associated with plant use	Provision of crane tracks and bases. Provision of hoist foundations. Temporary anchorages to structure of cranes and hoists. Foundations and service needs for mixing plants. Power supply for cranes, hoists, bar benders etc.
Safe places of work and access to them	Scaffolding. Required by law and to the standards laid down by regulation. In providing scaffolding, public safety must be considered – netting to stop falling materials, safe access under scaffolds which have to be erected over a pavement, etc.
Work in excavations	The law requires that all excavations more than 1.2m deep must be adequately supported. In addition, rescue equipment and testing facilities are necessary where there is risk of foul atmospheres in the excavation.
In situ concrete work	Provision of formwork and falsework adequate to resist the concrete pressures arising and the loads to be supported until the concrete is self supporting.
Erection of structural frame	Establishing special lifting gear, methods of work to achieve safe access and temporary supports to provide stability to structural members while in the process of erection.
The site set-up	Provision of site offices, toilets, storage facilities, first aid rooms, canteens and drying facilities and appropriate services. Where overseas work is concerned, camps and other facilities may also be needed.

‘No construction is possible without some form of temporary works’ (Illingworth 2000) and one would expect to see multiple types on a typical site. Coordination of TW is essential; failure to communicate the progress of all the TW in relation to permanent works may result in accidents occurring (Williams, et al. 2012).

Temporary Works Accidents

There is limited reliable data (main sources available are trade publications which may exaggerate or are missing key details) on TW accident reports. However, Gilbertson et al’s 2011 research into catastrophic events included a number of TW accidents which provide valuable insight into the causes of TW accidents. Of the 62 case studies, 17 were TW accidents mainly concerning scaffold collapse. The common causative factors included lack of site control and failure to identify risks. All reports

highlighted a lack of competent reviewing as a significant contributory factor, with additional themes including failure to coordinate design and construction, failure to recognise hazards, poor design, engineers not being meticulous about all aspects of TWs and a failure to control structural loading. The main conclusions from the research stated that ‘collapse of temporary works ranked highest of cases where lack of checking and competent reviewing contributed to events’ (Gilbertson et al 2011). This research aligns with Cameron’s (2011) report on scaffold collapses where HSE investigations found common causes included unsuitable scaffolding, inadequate loading controls and a lack of safe systems of work.

Gilbertson et al (2011) found that in 90% of scaffolding case studies, failure to recognise hazardous scenarios was a causative factor while 68% of interviewees felt lack of checking and competent reviewing were causal factors. Bell and Healey (2006) and Wearne (2008) also found organisational procedures and failure to check or spot warning signs were a greater cause of failure than faulty materials. Gilbertson et al (2011) concluded that lack of planning highlighted ‘the majority of accidents are not caused by careless workers but by failures in control by management.’

Reason (1990) theorised that accidents occur when holes (human error: latent conditions or active failures) in safety systems align. Figure 1 adapts the Loughborough ConCA model showing additional safety systems provided by the TWC (developed from Gibb et al. 2006).

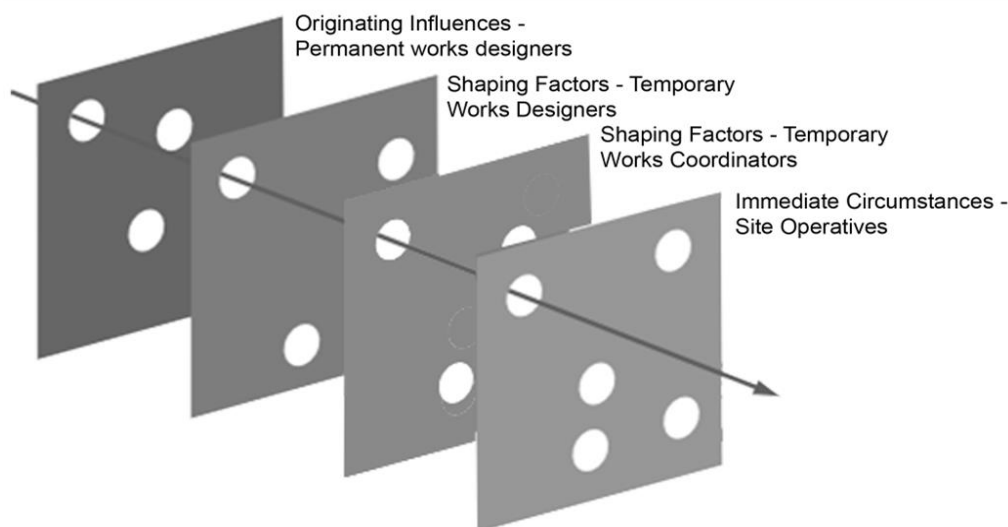

Figure 1: Adapted ConCA Model Showing TWC Role

Literature (e.g. Gilbertson et al. 2011 & Cameron 2011) identified potential holes in the plates to include incompetent reviewing, failure to coordinate design, failure to recognise hazards and failure to control structure loading. Interviewees expressed concern over human error in the TWC safety system, particularly a lack of TW design knowledge leading to hazards not being identified and a lack of checking of structures. Accidents are reported through RIDDOR, but Gilbertson et al. (2011) suggests only 40% of all accidents are reported, particularly by smaller firms. Both literature (Kletz 2009) and interviews revealed concerns over the reporting mechanisms available; in particular the lack of learning from accidents due to limited sources allowing companies to include information in TWC training – however literature

highlights this may be limited due to legal action. Publishing through the TWf restricts access to members, limiting access for trade magazines to avoid sensational reporting.

Temporary Works Coordinator

The UK's Chartered Institute of Building's (CIOB 2009) survey and report – Health & Safety in the Construction Industry – found TWCs were only appointed in 24% of projects of £200,000 or less, compared to 78% in projects over £15m. The report expressed further concerns of management standards, especially on small sites with Deebank (2010) highlighting that such concerns have already been raised in various HSE (HSE, 1997; 2001) and Institution of Civil Engineers publications (Grant and Pallet 2012).

TW design experience was the second most important attribute (32%). Concerns were expressed about the lack of design experience meaning TWC are unable to spot the design risks. Site experience was the most important attribute (42% industry, 71% TWf). Interestingly BS5975 and the TWf both rank the attributes of a TWC in the same order, and, while industry agrees with site experience ranking, it demotes training, qualifications and Chartership in favour of TW design experience. Despite over 30% of industry selecting TW design experience, no TWf member selected this, and its exclusion from BS5975 raises questions.

HSE (2001) indicated concerns over the role of the TWC and, a decade later, Grant and Pallet (2012) imply concerns still exist. They found TW accident causality include absence or inadequate TW procedures, inadequate design checking and poor construction execution; as previously noted it is the role of the TWC to ensure that checks are conducted. The Bragg report recommends 'proper training courses for TWC' (Bragg, 1976). However, findings from this study suggest 'a lack of training for both TWCs and TW designers' (Williams et al. 2012) with clear discrepancies between the training offered by the larger and smaller firms

Interviews

From the interviews it was noted that, although the initial design risk is often considered, sometimes late variations are not clearly critiqued by the permanent works designer for safety of workers. This causes frustration between parties, and communication breakdown resulting in contractors working in either a costly or unsafe manner (safety measures may be cut to save money). Cameron (2011) and Gilbertson et al (2011) also discussed concerns over time pressures from late design changes but concluded it to be insignificant in contributing to catastrophic events. However, it does appear to be a recurring concern which should be addressed.

When interviewees were asked about employers supporting them in their role, one highlighted that the TW design department was most significant while others noted a TW design department would be of benefit to them. Two interviewees felt the lack of industry understanding of the role of the TWC meant when there is no TW design department the design is shifted to the unqualified TWC - particularly when late alterations are made.

Interviews (Table 2) revealed companies base their selection criteria on these qualifications but there are inconsistencies. In particular one revealed chartered status meant over-qualification while for another it led to their appointment.

Table 2 Company Selection Policy

Interviewee	Recommendations from BS5975 and Company Policy				
	Engineering qualification	Five years site experience	TW design experience	Chartership	TWC Training
MC1	Yes	Yes			Yes
MC2	Yes	Yes	Yes		Yes
MC3	Yes	Yes – specific experience of relevant types of TW also required	No	Yes	Yes
MC4	Yes	No	No	Yes	Yes

The interviewees were all working with large Principal Contractors and all had received specific TWC training. Interestingly, the extent and focus of their training varied with concern expressed over the focus on company procedure rather than current industry problems with TW and recent accident causes. Interviews revealed initial training and refresher training provided, with refresher courses any time between three months and five years after initial training. Many felt the refresher training could be improved by focussing on recent accidents or new TW rather than company procedures – only one interviewee stated a predominant focus on accidents and new technologies.

Interviewees were complimentary about the guidelines, particularly since the revision, with one interviewee stating that the UK's guidelines on TW are extremely well developed compared to other countries. However, it was felt lack of publication within smaller companies means many TWCs may not be aware of their existence. Generally guidelines are perceived to be adequate, but industry opinion is inconclusive thus implying potential improvements may be beneficial. Interviewees indicated areas for improvement including additional sections detailing checks for common types of TW (particularly as this is the major role of the TWC) and common failures, again highlighting the need for improved accident reporting and publication to allow this to be implemented. Main contractors supplement current guidelines, including advising on common failures and problems encountered. Interviewees believed such improvements to BS5975 would aid those employed by smaller firms who perhaps do not have this support.

Interviewees stated the test should be based on BS5975, common TW safety check and common reasons for TW failures while questionnaire results (Figure 3) showed TW design principles should also be included.

Of those interviewed, all had passed an internal test based upon BS5975 and common checks to ensure competency of TWCs, and it was believed that most Principal Contractors employ internal testing to ensure competency. Failure to achieve the specified pass mark results in either a retest or further training and retesting. Interviewees noted the challenges for a test to include the variety of TW, thus limiting

subject material to standard types and concern that the test may become the only marker for competence resulting in the downgrading of site experience as an attribute.

Interviewees' knowledge of common types, particularly excavations, formwork and scaffolding was good, but many expressed a greater knowledge of one over the others due to their experience.

Questionnaire

There was an average 170 responses per question to the questionnaire via the LinkedIn Polls and 21 responses from members of the Temporary Works forum (TWf).

There were concerns echoed in the questionnaire results with over 60% identifying competency of the TWC as an issue. The questionnaires asked 'if TWC competency was improved the number of TW associated accidents be would reduced?' Figure 2 shows that an improvement in competency of TWC would lead to a reduced TW accident count, an opinion which was also shared by interviewee respondents.

If the competency level of TWCs was improved the number of accidents associated with TW would decrease

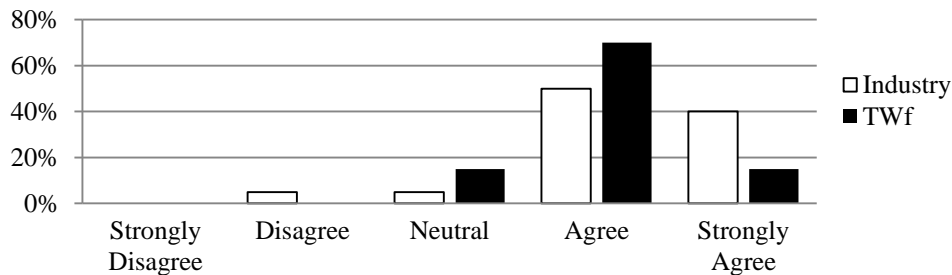
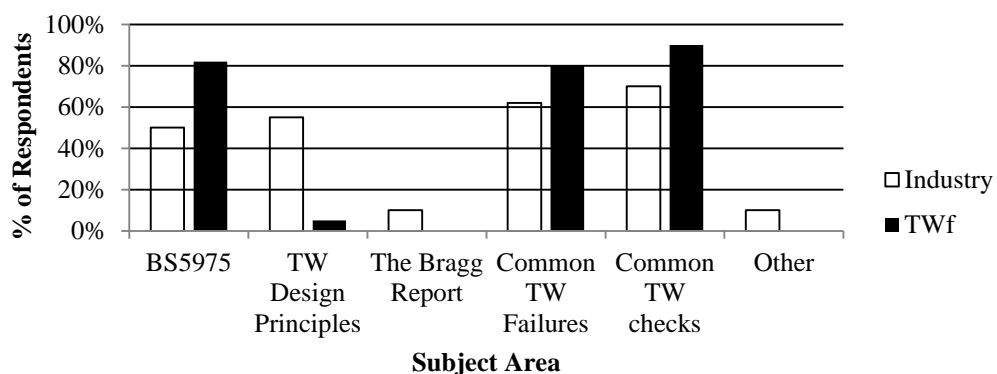

Figure 2: If TWC Competency Improved TW Accidents would Decrease

If a competency test was to be introduced, hat do you believe it should be based on? (Select all that apply)



Comments on LinkedIn polls highlighted an increasing number of consultant engineers are asked to provide TWCs and produce TW designs, which they felt unqualified for. The TWC should have a permanent site presence, which a consultant engineer cannot provide, again highlighting a lack of understanding of the role.

DISCUSSION

The preliminary investigation and subsequent literature review identified the design of TW to be problematic with a lack of understanding or incorrect interpretation to be a causal factor of TW accidents. Statements specific to TW included reduced loads and incompetent (or failure to appoint) designers. Permanent works design issues were also highlighted with a tendency to 'design in risks.' MacKenzie et al. (2000) identified the purpose of The Construction (Design and Management) Regulations (CDM) was to combat 'integrated design risk' and placed a duty on designers to consider construction risks, but further research has been unable to prove the success of this regulation and significant changes are expected.

The TWC should ensure that a suitable TW design is prepared, checked and implemented on site in accordance with the relevant drawings and specification (CEST 2010). BS5975 states preferred qualifications (including experience, training and Chartership) but no definitive qualification is expressed. Interviews revealed companies base their selection criteria on these qualifications but there are inconsistencies. In particular one revealed chartered status meant over-qualification while for another it led to their appointment.

Interviewees highlighted concerns over shortcuts being taken (due to a lack of understanding of design principles) while respondents felt appointment of inexperienced TWCs was the cause of competency concerns.

A UK competency card scheme - The Construction Skills Certification Scheme (CSCS) - was introduced in the 1990s in a drive to improve competence and reduce accidents. It allows assessment of specific trades in addition to a mandatory H&S test which is often a pre-requisite to working on a major site. Although literature suggests many do not recognise this as a competency based scheme, interview and questionnaire respondents favoured this method of assessing competency.

The preliminary investigation and subsequent literature review revealed that, although a CSCS competency test exists for other trades and professions there is not one for TWCs. Interviews and questionnaires found the introduction of a test would improve the competency of TWCs and importantly, one under the CSCS banner is currently being discussed in response to the competency issue

Over 85% of respondents felt if TWC competency improved, the number of accidents associated with TW would decrease. The competency of TWCs is poor with many accidents due to the failure to recognise hazards and failure to check structures. However, literature (Reason, 1990; Gibb et al. 2006) highlights that accidents have multiple causes, involving different people or organisations, of which the TWC is one. The CSCS test is the main current procedure to improve competency and most Principal Contractors require all employees to be card holders, however there is no specific test for TWCs.

The TWf and industry generally believed the guidelines to be adequate. Potential improvements suggested included providing information on common checks and failings. Although no specific definition of TW exists, industry believed that TWCs should have a broad understanding of all types of TW, whereas the opinion of the TWf is inconclusive. There is no clear training content or refresher time frame for TWC training which can vary from every three months to every five years.

The most important attribute for a TWC is five years site experience according to industry. While the TWf favour this attribute above others, the industry also favours TW design experience despite no one from the TWf selecting this. Principal Contractors generally base their selection policy on the guidance of BS5975 but differ in priority of attributes - Chartership in some instances is a requirement but in others signifies over-qualification. Training is provided, but no standard content or interval time frame exists between the companies interviewed.

The introduction of a test for TWCs would improve their competency level and would be supported by industry, particularly as it echoes measures already in place by most large construction firms. The test should be based upon BS5975, common TW failures and common TW checks and, although not selected by the TWf, over 50% of the industry also wanted TW design principles included. It is worth highlighting that, if a test was introduced, it is likely the TWf would determine the topic areas and this question highlights that, although the forum may not consider it an important subject area, the industry does.

A test would improve competency, but the practicality of such a test is questionable. All TWCs had completed a test before appointment and felt industry wide testing would be beneficial. Interestingly it appears a test may be introduced in the future under the CSCS banner. A standard test would improve competency with all TWCs having completed an internal test prior to selection and a test under the CSCS banner is currently being considered in response to the competency issue.

CONCLUSIONS

In the UK the role of the TWC is felt to be important in the prevention of TW accidents. Since the introduction of the role there has been confusion (such as whether it is to 'check the TW themselves' or 'ensure someone else has checked the TW') in the construction industry as to what it entails and therefore a lack of support.

Guidelines for the design and supervision of TW have been well received but some clarification is required as to the required respons of the TWC so that a test for competency can be introduced.

REFERENCES

- Bell, J., & Healey, N (2006) "The Causes of Major Hazard Incidents and How to improve Risk Control and Health and Safety Management: A Review of the Existing Literature" – HSL/2006/117, Buxton, Health and Safety Laboratory (HSL)
- Bragg, S. L (1976) "Final report of the Advisory Committee on Falsework".
- BSI (2011) BS 5975: 2008 + A1: 2011 "Code of practise for temporary works procedures and the permissible stress design of falsework". BSI, London
- Cameron, L (2011) "SHE11 – Competence, checks and communication key to CDM compliance." Safety and Health Practitioner [online] Available at: <http://www.shponline.co.uk/news/news/full/she11-competence-checks-and-communication-key-to-cdm-compliance> [Accessed 30th April 2014]
- CEST (Construction Engineering Specialist Team) (2010) "The management of temporary works in the construction industry". [online] Available at: <http://www.hse.gov.uk/Scotland/temporary-works-management.pdf> [Accessed 30th April 2014]

- Deebank, P (2010) "CPD: Management of temporary works." [online] Available at: <http://construction-manager.co.uk/cpd-zone/subject-area/temporary-works/> [Accessed 24th September 2012]
- Gibb, A.G.F., Haslam, R.A., Hide, S., Gyi, D.E. & Duff, A.R. (2006) "What causes accidents". *Civil Engineering*, Proceedings of the Institution of Civil Engineers, Vol. 159, Special Issue 2, November 2006, pp. 46-50, ISSN 0965 089 X
- Gilbertson, A., Kappia, J., Bosher, L. & Gibb, A.G (2011) "Guidance on catastrophic events in construction". CIRIA Publications.
- Grant, M and Pallet, P (2012) "Temporary works: principles of design and construction". London: ICE Publishing. ISBN:978-0-7277-4177-6.
- Kletz, Trevor A (2009) "Accident reports may not tell us everything we need to know". *Journal of Loss Prevention in the Process Industries* 22.6: 753-756.
- HSE., (Health and Safety Executive) (2001) "Investigation into aspects of falsework". HSE Contract Research Report 394/2001. HSE Books, Sudbury. Available at www.hse.gov.uk/research/crr_hrm/2001/crr01394.htm
- Illingworth, J.R. (1987) "Temporary works their role in construction". London: Thomas Telford
- Illingworth, J.R. (2000) "Construction methods and planning". Spon Press.
- MacKenzie, J., Gibb, A. G., & Bouchlaghem, N. M (2000) "Communication: the key to designing safely". European Construction Institute TF, 77-84.
- Reason, J (1990) "Human Error". Cambridge University Press.
- Standing Committee on Structural Safety (SCOSS) (2010) "Falsework: Full Circle?" [online] http://www.structural-safety.org/media/24135/113_SCT02.01___Falsework_Topic_paper_Reissued_Aug10.pdf [Accessed 16th January 2014]
- Weame. S (2008) "Organisational Lessons from Failures". *Civil Engineering*, 161(6): 4-7
- Williams, S. C., Bust, P. D., Finneran, A. M., & Gibb, A. G. F (2012) "Defining temporary works in the construction industry: Health and safety issues". *Contemporary Ergonomics and Human Factors* 2012, 71.

INVESTIGATING SAFETY MANAGEMENT ON CONSTRUCTION PROJECTS

Rafiq M. Choudhry

⁴⁶Rafiq M. Choudhry, Department of Civil & Environmental Engineering, College of Engineering,
KingFaisal University, Hofuf, Al-Ahsa-31982

Safety management on construction sites is a major issue all over the world and situation is more serious in developing countries. There are no formal governmental regulations for implementing a safety management system on construction projects in Pakistan. This study assesses implementation of safety management on construction projects with a purpose of improving safety on construction sites. Data were collected through a questionnaire survey from construction sites. The collected data were statistically analyzed. The results revealed that top management commitment is imperative for developing and implementing safety management systems. Results indicate that safety responsibilities were defined for the staff. Safety officers and safety supervisors conducted safety inspections and safety signs were prominently displayed at the construction sites. Personal protective equipment were provided and construction managers maintained a record of accidents occurring during the execution of project activities. Results emphasized the requirement of competent staff for implementing safety on construction projects. The information obtained from this study may be useful to many construction companies for improving on-site safety.

Keywords: Construction industry, Construction sites, Safety framework, Safety management.

INTRODUCTION

Construction is a risky process because of outdoor operations, work-at-heights, complicated on-site plants, and equipment operations (Choudhry and Fang 2008). A safety management system is considered as the basis for safely managing site operations (Choudhry *et al.* 2008). It consists of all the requirements including policies, objectives, roles, responsibilities, accountabilities, codes, standards, communications, processes, procedures, tools, data and documents that are necessary for imparting safety on construction sites (Choudhry *et al.* 2007). In developing countries as Pakistan, safety regulations usually do not exist, and if they exist, the regulatory authorities are typically very weak in enforcing these regulations effectively. Generally, the relevant regulations are outdated and irrelevant in day-to-day construction operations (Tam *et al.* 2004; Ali 2006). Site safety is a complex phenomenon and the subject of attitudes and safety performance in the construction industry is even more complex (Choudhry *et al.* 2007). The economic effects of an accident can be devastating, apart from human suffering. Accidents on construction sites occur either due to lack of knowledge or training, a lack of supervision, or a lack of means to carry out the task safely, or alternatively, due to an error of judgment,

⁴⁶ rchoudhry@kfu.edu.sa

carelessness, or apathy (Teo *et al.* 2004; Fang *et al.* 2004). Studies have shown that hazards can be controlled and accidents can be prevented through the implementation of basic safety practices leading to a sound safety program (Sawacha *et al.* 1999; Choudhry *et al.* 2008).

Hale *et al.* (1997) showed that safety management had become a topic of increasing interest. Safety management has produced a dramatic growth in the development and use of management system audits to assess whether a safety management system (SMS) is adequate or not; and how it can be improved. Many construction companies around the world are implementing safety, health and environmental management systems to reduce injuries, eliminate illness, and to provide a safe work environment on their construction sites (Choudhry *et al.* 2008). The term safety management is used for convenience and for brevity, and wherever it is used, it is assumed to refer the management of occupational health and environment as well as safety (Choudhry *et al.* 2008). Safety management is concerned with, and achieved by the techniques that promote safety. Safety management is also concerned with influencing human behavior, and with limiting opportunities for mistakes to be made, which result in harm and loss.

Implementation of safety management system is still far from happening in the construction industry. This paper investigates implementation of a safety management on construction site environment in Pakistan. Specifically, the following objectives are considered for this research: 1) To study practices of safety management followed on construction sites; 2) To conduct a safety management survey on construction projects to examine how safety management systems operate on various construction sites for improving site safety.

METHODOLOGY

This study was carried out in phases including the preliminary study, data collection, data analysis, and results reporting. In the preliminary study phase, relevant literature was searched to gather background data. A questionnaire was adopted from Choudhry *et al.* (2008) and data were collected by conducting a safety management survey in the country. The safety management questionnaire was distributed by having face-to-face meetings and through email communications with top management representatives of construction companies including project directors, project managers, safety managers, safety officers and site engineers. Safety-related information were obtained from construction sites. In the data analysis phase, the data were entered in a statistical analysis software package SPSS 17.0. The data were analyzed and the results are reported for the purposes of documentation and improving safety on construction sites.

A questionnaire was used as the principle survey instrument. A pilot survey was conducted on three construction projects to verify the applicability of the questionnaire in the local construction environment, followed by the interviews. From the feedback, the questionnaire was amended, and a final questionnaire consisting of 25 questions covering seven aspects of safety management was administered. The final questionnaire had a general information section, which included respondent's organization name, name of the project, position in the organization, address, work experience in the construction industry and education. This section was followed by seven sections of the safety management system, including health and safety policy,

safety organization, safety training, safety inspections, safety promotion, personal protection program, and documentation and accident prevention. Respondents were asked to answer either 'yes' or 'no' to each question. A total of 70 questionnaires were distributed, of which 55 (78.6 percent response rate) valid responses were received. Table 1 shows the 25 questions, with the numbers from 1.1 to 7.3 referring to question numbers in the questionnaire.

Table 1: Percentage of respondents with affirmative responses

Q. No.	Question statement	Yes (%)
1.0	<i>Health and Safety Policy</i>	
1.1	Has your company developed a health, safety and environmental policy?	63.6
1.2	Does the policy clearly state that decisions on other priorities should give due regard to construction safety requirements?	61.8
1.3	Does the policy commit the organization to full compliance with all relevant health and safety standards?	43.6
1.4	Does the policy set targets for health and safety performance including a commitment to progressive improvement?	50.9
1.5	Does the policy identify key senior personnel for overall coordination and implementation of the policy?	61.8
1.6	Does your company allocate any financial budget to safety?	58.2
2.0	<i>Safety Organization</i>	
2.1	Is there an organization chart showing the names and positions with responsibility lines for safety performance management?	32.7
2.2	Have the individual health and safety responsibilities of all employees been clearly defined?	45.5
2.3	Have sufficient competent safety officers and safety supervisors been appointed and engaged for the site?	30.9
2.4	Are subcontractors required to submit site-specific safety plans?	20.0
3.0	<i>Safety Training</i>	
3.1	Is there a health and safety training plan?	38.2
3.2	Is any training given to new employees?	29.1
3.3	Is safety training a compulsory item within the budget?	32.7
3.4	Are training sessions given to in service employees?	43.6
4.0	<i>Safety Inspections</i>	
4.1	Do safety officers and safety supervisors carry out safety inspections at regular intervals?	40.0
4.2	Does your company conduct safety audits during project execution?	32.7
5.0	<i>Safety Promotion</i>	
5.1	Are safety bulletin boards provided and located so that every employee will see them during working days?	34.5
5.2	Are safety signs and posters prominently displayed on site?	41.8
5.3	Are safety awards given on a regular basis with recognition set for good safety performance by individuals?	14.5
6.0	<i>Personal Protection Program</i>	
	(Safety helmet, safety shoes, safety goggles, safety gloves, ear muffs)	
6.1	Have the requirements for the provision of personal protective equipment (PPE) been indicated in the contract agreement and in the safety plan?	67.3
6.2	Has a sufficient stock of carefully selected and appropriate PPE been obtained?	56.4
6.3	Has an effective system for the issuance, recording, and inspection of PPE and replacement PPE been established?	32.7

Q. No.	Question statement	Yes (%)
7.0	<i>Documentation and Accident Prevention</i>	
7.1	Has any arrangement been made by your company to keep records of accidents occurring during the execution of project activities?	50.9
7.2	Is there any staff hired for keeping the proper documentation of accidents and for updating this record?	3.6
7.3	Is any policy or plan developed for accident prevention on the construction site?	30.9

RESULTS

The percentage of the respondents who answered “yes” to the various questions is presented in Table 1. The average positive response rate to all the questions was 40.72. Seven aspects of safety management and their relative consideration is explained next from the analysis of the responses.

Health and Safety Policy

The survey results for the questions regarding safety policy are numbered from 1.1 to 1.6 as shown in Table 1. The results for question 1.1 (Has your company developed a health, safety and environmental policy?) show the valid positive response rate of 63.6%, which indicates that on most of the construction sites the contractors placed considerable importance on the development and implementation of an HSE policy. The valid positive response rate was 61.8% for question 1.2 showing that the HSE policy developed by construction companies for their projects clearly state that decisions on other priorities are to give due regard to construction safety requirements. For question 1.3, 43.6% was the positive response rate for the surveyed construction sites; which shows that the policy was developed by fewer companies, which meets the safety standards such as the Occupational Safety and Health Administration (OSHA). The valid yes response rate for question 1.4 was 50.9% which gives a clear indication that on half of the construction sites, the policy implemented sets targets for health and safety performance including a commitment to progressive improvement. For question 1.5, the valid positive response rate was 61.8%; which indicates that key senior personnel were there for the overall coordination and implementation of the policy. For question 1.6, it is clear that 58.2% of the construction companies allocate budgetary funds to safety.

Safety Organization

On each construction project, it is necessary to display charts on the notice boards indicating the responsible safety advisor for every section of the project (Choudhry 2007). The valid response rate was 32.7% for question 2.1 which indicates that out of 55 construction sites surveyed, only 18 had an organization chart showing the names and positions with responsibility lines for safety performance management. For question 2.2, the response rate was 45.5%, which is above the mean of 40.72; indicating that the individual health and safety responsibilities of employees were defined to some extent on several of the projects surveyed. The positive response rate for question 2.3 of 30.9% indicates that only 17 out of 55 construction companies working on the construction projects have appointed competent officers and safety supervisors having qualifications in safety or having experience of working on construction sites. The score for question 2.4 (Are subcontractors required to submit

site-specific safety plans?) of 20% reveals that this is the area where construction companies need to pay more attention as most of the work is performed entirely by subcontractors. The subcontractors are required to prepare and submit site specific safety plans for all of their construction activities.

Safety Training

The valid positive response rate for question 3.1 was 38.2%, indicating that there is a need for a project health and safety training plan. It is to be submitted along with the other documents at the time of bidding and needs to be a part of the contract documents. The positive response rate for question 3.2 was 29.1%, which indicates that construction companies did deem it important to train their employees. Top management involvement is required for training to be made compulsory for every new employee inducted in the company. The results for question 3.3 gave a positive response rate of 32.7%. It shows that there is still a need to incorporate safety training as a compulsory item within the budget. The valid positive response rate was 43.6% for question 3.4, indicating that there is a trend within the construction companies to train their employees by introducing different courses related to their trades or to transport them to other places for training purposes. From the results of questions 3.1, 3.2, 3.3 and 3.4, it appears that only some construction companies are taking proactive steps in safety training of their staff.

Safety Inspections

Results of questions 4.1 and 4.2 showed valid positive response rates of 40% and 32.7%, respectively. The result of question 4.1 indicates that some safety officers and safety supervisors carried out safety inspections at regular intervals, particularly weekly. While results from question 4.2 indicate that less than a third of the surveyed projects (18 out of 55) had safety performance measured by conducting safety audits during project execution on a monthly or annual basis. Safety audits are good tools for measurement of safety performance on construction projects as they can check whether safety is implemented according to the site safety plan or to improve it by comparing it to a record of previous safety performance.

Safety Promotion

Results for question 5.1 indicate that on 19 out of 55 construction sites, safety bulletin boards were provided so that every employee would see them during working days. The valid positive response rate was 34.5%. This indicates that safety bulletin boards easily understandable to workers are to be provided by construction companies. Depending on the site conditions, information are to be provided in local language and or in English language. The signs should be prepared so workers can easily understand them, even if the workers are illiterate. The results for question 5.2 show the valid positive response rate of safety signs and posters prominently displayed on site was 41.8%. Safety signs and posters need to be prominently displayed on site, so that every employee working on the site can see them and be encouraged to work safely. It is a good practice that the company displays signs and posters near work areas to enhance precautionary measures (Choudhry 2007). For question 5-3, the valid positive response rate was 14.5%, which indicates that there is a need for safety awards or recognition to be given on a regular basis for good safety performance by individuals working on a specific project. For promotion of safety on site, different schemes can be explored, such as Best Safe Site Competition, Best Safe Foremen Competition, Best Safe Worker Competition, etc.

Personal Protection Program

Results for question 6.1 gives the valid positive response rate of 67.3% (37 out of 55 construction sites surveyed), that the requirements for the provision of personal protective equipment (PPE) had been indicated in the contract agreement and the safety plan. The results of question 6.2, showed the valid positive response rate of 56.4%. On construction sites surveyed, there was an increased trend to obtain a sufficient stock of carefully selected and appropriate PPE either provided in the BOQ or purchased by the construction companies for their workers. The valid positive response rate for question 6.3 was considered low at 32.7%. There is a need to establish an effective system for the issuance, recording, and inspection of PPE and their replacement by the construction companies.

Documentation and Accident Prevention

Results of question 7.1 showed that 28 out of 55 (50.9%) construction companies working on the projects had an arrangement to keep record of accidents occurring during the execution of project activities. The valid positive response rate for question 7.2 was a low of 3.6%. This shows clearly that staff is rarely hired to keep the proper documentation of accidents occurring and updating the information on the construction sites. The valid positive response rate was 30.9% for question 7.3, which was also considered to be a low value. It is the responsibility of the senior key personnel of the organization working on the project to develop and implement a policy and plan for accident prevention on-site during the execution of construction activities. The overall results from questions 7.1, 7.2 and 7.3 indicate the need for construction companies to implement proper documentation for all the activities executed and also to have an accident prevention plan to ensure safety on project sites and to avoid any unforeseen events or accidents.

CONCLUSIONS AND RECOMMENDATIONS

The safety management survey explored seven aspects of site safety management including health and safety policy, safety organization, safety training, safety inspections, safety promotion, personal protection program, and documentation and accident prevention. Results showed that safety practices were good in the aspects that safety responsibilities were defined for the staff. Safety officers and safety supervisors conduct safety inspections at regular intervals. Safety signs were prominently displayed on the construction sites. Personal protective equipment (PPE) were procured as required in the contracts. Construction sites recorded accidents occurring during execution of project activities. The following points require attention that top management needs to implement a safety management system. The safety organizational chart needs to be displayed on site. Competent safety staff needs to be appointed to be responsible for the implementation of safety on-site. The concept of the submission of a site specific safety plan by the subcontractors needs to be implemented in the construction industry. Health and safety training plans, induction training of new employees and a dedicated budget for safety is to be in place for implementing the safety management system. Safety performance needs to be checked at regular intervals by management by means of conducting safety audits. Safety bulletins need to be provided and different award or recognition schemes need to be introduced to motivate and increase the safety awareness of workers at project sites. The documentation of the safety record and accident prevention policy and plans require attention by top management.

REFERENCES

- Ali, T. H. (2006). "Influence of National Culture on Construction Safety Climate in Pakistan." Doctor of Philosophy, Griffith University, Gold Coast campus.
- Choudhry, R. M., Fang, D., and Mohamed, S. (2007). "Developing a Model of Construction Safety Culture." *Journal of Management in Engineering*, 23(4), 207-212.
- Choudhry, R. M., and Fang, D. (2008). "Why operatives engage in unsafe work behavior: Investigating factors on construction sites." *Safety Science*, 46(4), 566-584.
- Choudhry, R. M., Fang, D., and Ahmed, S. M. (2008). "Safety Management in Construction: Best Practices in Hong Kong." *J. Prof. Iss. Eng. Educ. Prac.*, 134(1), 20-32.
- Choudhry, R. M., Fang, D., and Mohamed, S. (2007). "The nature of safety culture: A survey of the state-of-the-art." *Safety Science*, 45(10), 993-1012.
- Fang, D. P., Huang, X. Y., and Hinze, J. (2004). "Benchmarking Studies on Construction Safety Management in China." *J. Constr. Eng. Manage.*, 130(3), 424-432.
- Hale, A. R., Heming, B. H. J., Catfhey, J., and Kirwan, B. (1997). "Modelling of Safety Management Systems." *Safety Science* 26(1-2), 121-140.
- Hinze, J. W. (2006). *Construction Safety*, Prentice-Hall, Inc., Upper Saddle River, New Jersey.
- Sawacha, E., Naoum, S., and Fong, D. (1999). "Factors affecting safety performance on construction sites." *International Journal of Project Management*, 17(5), 309-315.
- Tam, C. M., Zeng, S. X., and Deng, Z. M. (2004). "Identifying elements of poor construction safety management in China." *Safety Science*, 42(7), 569-586.
- Teo, E. A. L., Ling, F. Y. Y., and Chong, A. F. W. (2004). "Framework for project managers to manage construction safety." *Int. J. Proj. Manage.*, 23(4), 329-341.

DRUG AND ALCOHOL USE IN THE AUSTRALIAN CONSTRUCTION INDUSTRY: A CASE STUDY

Ehsan Gharai⁴⁷, Terry Hatzimagas⁴⁸, Claude Zeina⁴⁹

¹RMIT University, Melbourne, Australia

The Australian construction industry was within the top three industries in Australia with the highest rate of work related fatalities in 2012. The 2010-11 data show that 12,985 serious workers' compensation claims were recorded in this industry. There are anecdotal evidences for the impact of drug and alcohol use. However, this needs further investigation. This paper investigates the extent of drug and alcohol use in a large construction project in Australia. It explores the extent of the exposure to the risk, age group, work experience, and occupation of the users. It also examines the workers' perception toward random testing, and seeks the underlying causes. A mixed method approach was adopted. Quantitative data were collected through survey of 72 construction workers. The results showed that 22% of respondents admitted to being under the influence of drug and 47% admitted to being under the influence of alcohol while at work. 35% of respondents have seen someone at work under the influence of drug or alcohol in the last 12 months. The majority of the users were labourer. In regard to prevention policies, a random test would not bother 86% of the respondents. Five interviews with safety and project managers were also conducted in order to gain in depth knowledge and find underlying causes. Some of the causes mentioned include: long working hours, work stress particularly at high risk work, mental health issues, recreational purposes, cultural norms and peer pressure, education level, and family stresses. The study confirms the previous research in this area and provides an evidence for the high drug and alcohol use in the Australian construction industry. It demonstrates the random testing as an immediate preventive method would be acceptable by the workers. However, eradicating the problem would need a more comprehensive approach that addresses the underlying causes.

Keywords: Construction health and safety, drug, alcohol, random testing

INTRODUCTION

Construction Industry is a major contributor to Australia's economic stability and growth. The industry's share of the total production of goods and services in the Australian economy was 7.7% and it employed an average of 1,033,900 people in 2010-11 (ABS 2012). However, over the five years from 2007-08 to 2011-12 the industry accounted for 11% of all serious workers compensation claims. Due to the high number of injuries and fatalities, the industry has been identified as a national priority for prevention activities in Australian Work Health and Safety Strategy 2012-2022 (Safe Work Australia, 2012). This strategy also suggests evidence based improvement policies.

⁴⁷ ehsan.gharaie@rmit.edu.au

⁴⁸ terry_hatzis@hotmail.com

⁴⁹ claude.zeina@hotmail.com

In general, approximately 20-25% of workplace injuries are a result of drug and alcohol use. It is also estimated that the use of drugs and alcohol in the workplace costs Australian businesses \$3.7 billion per year (WorkCover Corporation, 2001). There are anecdotal evidences that construction industry is no exception. However, the impact of this issue in the industry has not been fully investigated due to the lack of robust and consistent evidences.

This research uses a large construction project as a case study and investigates the extent of alcohol and drug use between the workers involved in the project. It also explores the possible underlying causes and potential impacts on the health and safety of the workers. A mixed method approach is adopted. Quantitative data are collected through survey of seventy two workers and qualitative data were collected through interviews.

The following sections describe the research design, present the results, draw conclusions, and make recommendations. It needs to be noted that the relevant literature is reviewed in the discussions and recommendations section.

RESEARCH DESIGN

The aim of the research was to investigate the extent of the use of drug and alcohol in construction sites using a large construction project. To address that aim, the research objectives were to find out the possible presence of alcohol and drug use in the site, frequency of the use, some attributes of the users, and the potential reaction of the construction workers to the random testing. Further, the research investigated some underlying causes of the drug and alcohol use through interviews with construction project and safety managers.

Case study is an ideal methodology used when a holistic and thorough investigation is needed in order to research a specific issue (Yin, 2009, Feagin, et al, 1991). Therefore, it was adopted for this research. The research method adopted for the study was a mixed method.

Quantitative method

The data related to the extent of drug and alcohol use in the project were collected through the survey of seventy two employees. The survey incorporated seven questions to ensure that the respondents did not become aggravated by taking too long to complete.

The following questions were asked:

- What age group do you belong in? (Optional)
- How many years have you been working in the construction industry? (Optional)
- Have you ever noticed a co-worker to be working under the influence of drugs or alcohol while at work in the last 12 months?
- Have you ever noticed a co-worker to be working under the influence of drugs or alcohol while at work in the last 5 years?
- What was the occupation of that person?
- What was the age group of that person?
- Have you ever been under the influence of drugs while at work?
- Have you ever been under the influence of alcohol while at work?

- If random drug testing passed legislation would it bother you?

Qualitative method

Following the quantitative data collection and the statistical analysis, five face-to-face interviews were conducted with three managers and two OHS officers in the project. The interviews were semi structured and the questions were guided by the result of quantitative analysis. The interview questions that were asked were:

- Have you ever seen an employee under the influence of drugs and/or alcohol in any project you have worked on in the past?
- What are the reasons for the use of drugs and alcohol in the construction industry?
- Is there any industry policy that can be implemented to reduce the use of substances in the Construction Industry?
- What would be the workers' perspective if they are regularly 'policed' on construction sites?
- If the mining and petroleum industries have a zero tolerance to drug and alcohol use, then do you believe the construction industry should be the same?

QUANTITATIVE RESULTS

Survey population characteristics

To ensure the anonymity of the survey, the research team could not ask too many questions about the participants. This information was limited to the age and experience of the respondents in the industry. 26% or 19 people were between the ages of 25-30 years old, making up the majority of the surveyed respondents, as depicted in figure 1a below. The next highest result was 18%, comprising of 36-45 year olds.

The nonparametric significance test has been conducted on the sample in regard to the age group. The significance level was 0.05. The chi-square p-value of 0.233 has shown that the age group results occurred with equal probability.

38% or 27 respondents had worked in the construction industry for more than 10 years, making this the majority of people surveyed. As shown in Figure 1b, there were 22 respondents that have worked in the construction industry between 5-10 years, creating a result of 30% of respondents. There were 12 respondents, or 17% that had worked in the construction industry for 1-5 years, while 11 respondents had been working in the industry between 0-12 months, creating a result of only 15%.

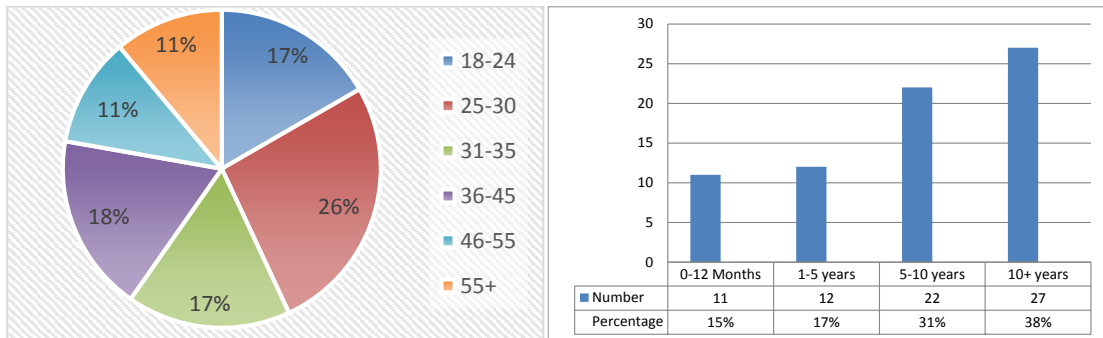

Figure 1: a) the age of respondents as a percentage of survey population, b) respondents experience in the industry

Exposure while at work

There were 35% of respondents who had been exposed to a co-worker working under the influence of drugs or alcohol in the last 12 months. 11 respondents comprising of 15% of the results, were exposed only one time, 5 respondents more than 2 times, while 9 respondents or 13% had indicated that they had seen co-workers under the influence more than 2 times in the last 12 months.

The p-value of nonparametric chi-square significance test of the proportion of the sample that have been exposed to a co-worker under the influence was 0.402 showing the number of exposures occurred with equal probabilities.

In the past five years, 43% of the survey population, 31 respondents, said that they have seen a coworker under the influence of drug and alcohol in site. From this, 21 respondents or 28% of the population had indicated that they had seen co-workers to be working in site while under the influence more than 2 times in the last 5 years.

Occupation and age group

The survey questions continued with further detail about the workers who were under the influence of drug or alcohol. As demonstrated in figure 2a, labourers were the most recognised occupation with a total of 22 respondents recognising this. Sub-contractors followed with 7 respondents indicating this.

Equipment operators are constantly at risk in construction projects with high rate of fatalities and injuries (Lingard et al 2013). Being impaired by alcohol or drug would make the situation even worse. 6 respondents in the survey population have seen an equipment operator under the influence while at work.

33% had been between the ages of 18-24 years old. The results also showed that 15 co-workers or 31% of them had been between the ages of 25-30 years old. 31-35 years old followed with 9 co-workers that had been noticed to be working under the influence, while 5 co-worker were found to be between 31-35 years old and 4 co-workers were found to be between 46-55 years old. As can be seen in figure 2b, there was an inverse correlation between the age group and the number of observations.

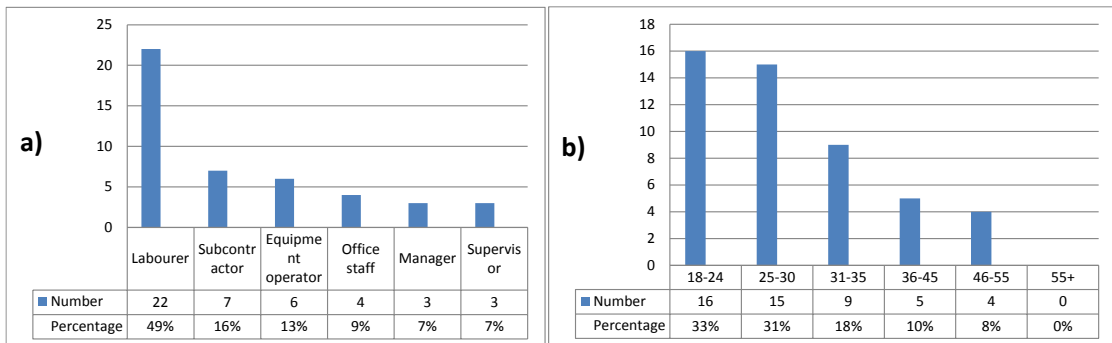

Figure 2: Occupation and age group of the users

Drug and alcohol use while at work

The respondents were also asked whether they themselves had ever been under the influence of drugs or alcohol while at work.

16 of the 72 respondents or 22% of the survey population admitted to have been under the influence of drugs and 34 or 47% of the respondents admitted to have been under the influence of alcohol at some stage while at work. The age groups of these self-admitted respondents are shown in figure 3.

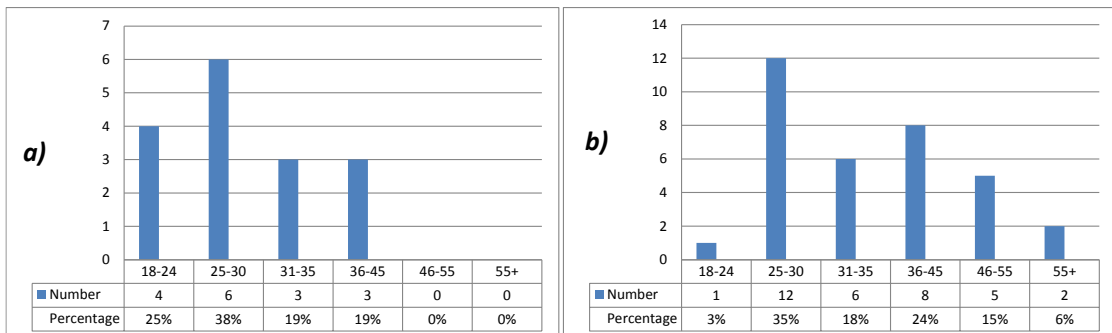

Figure 3: Number of self-admitted respondents by age group under the influence of a) drugs, and b) alcohol.

Perception toward random testing

The research team asked the respondents if they would be bothered, should random drug testing pass legislation. Of the 72 respondents, 62 (86%) responded how they would not be bothered if random drug testing passed legislation.

QUALITATIVE RESULTS

The research team conducted five interviews with two OHS officers and three managers. The questions were related to their experiences with drug and alcohol use in the construction industry.

Personal observation

The research team found that all five interviewees had experienced a co-worker or employee to be under the influence of drugs or alcohol at some stage throughout their careers. Both OHS officers and all three managers could recite countless stories and

incidents whereby an employee had been deemed unfit to work due to being under the influence of either drugs or alcohol.

In one of the more serious cases noted, a manager explained how in July of 2013, a plasterer on their site had tried to suicide by elevating himself on a scissor lift and slitting his wrists in a hysteric and panicked state. The site was immediately shut down and police, ambulance and negotiators were called to the site to try and talk sense into the plasterer. Unfortunately, the obvious drug affected plasterer would not cooperate. Since the ambulance was present, the police decided it was fine to wait until he was weak enough to bring him down and not pose as a threat. This took between 5-6 hours. The manager explained how “once treated in hospital he was taken to an institute to recover as he was in a manic state from the concoction of drugs. It took three days before he had calmed down enough for them to assess him”. The manager had later learnt that this had all come about as he had a ‘big weekend on the gear’ as he had told one of his colleagues and was worried about how he was to support his soon to be child. The manager then added how all the employees were offered counselling and depression support help lines.

The reasons for drug and alcohol use

Long working hours was the first reason mentioned by the interviewees. Some employees in the construction industry are asked to work up to 12 hours a day, every day. Two of the managers argued that employees cannot always handle these constant long hours and decide to take drugs in order to get through the day and prolong their working abilities.

Personal stress was another answer that all interviewees agreed upon. When people are stressed at work they sometimes see drugs or alcohol as something that can help lower stress by temporarily eradicating their problems. This is the case especially for high risk work.

One OHS officer also added that another reason for drug and alcohol use in the industry is individuals trying to cope with family break ups and other family issues. Employees sometimes turn to these substances to try to forget about issues concerning themselves and their family at home. The OHS officer added that ‘the rate of divorce and family break ups is around 45-56%’, so there would be a fair few people attempting to deal with those issues while under other stresses of work.

Drinking Culture: All five interviewees also agreed that the Australian culture plays a major role in why employees use drugs and alcohol. One manager argued how it is ‘embedded in the Australian culture to have a drink after work’. Drinking alcohol has always been part of the Australian culture. This is shown constantly on most television channels and in a lot of advertisements. Another manager noted the Victoria Bitter advertisement, explaining how even its main catch line is ‘a hard earned thirst needs a big cold beer and the best cold beer is Vic’. Having a drink after work is engraved in the Australian culture, that if someone works hard, they deserve a nice cold beverage.

The same interviewee also mentioned that even though it may not be the correct thing to do, the weekly ‘Friday after work drinks’ has become an informal company routine. Going to the local pub at the end of the week symbolises a celebration another week ending. This again reiterates the acceptance of alcohol consumption. Even though the consumption of alcohol is not being performed on the construction site, the employees

notice management allowing drinking after work, so it therefore is perceived as acceptable to perform at any time.

The drinking culture produces peer pressure. This is mostly true in the younger generation, whereby joining in to have an alcoholic beverage during or once work is complete is almost like an initiation into the Australian workforce.

Mental issues: one manager and both OHS officers believed that some employees use drugs or alcohol due to underlying mental issues that have yet to be dealt with. Some employees indulge in these substances as a way to try and cope with the pressures of society, in an attempt to self-medicate as they could be dealing with depression or other mental health issues.

Level of Education: All three managers also believed that some employees use drugs and alcohol simply because of the general demographic. They explained how the demographic of people affected by drugs or alcohol in the industry are not those who are the construction professionals, instead the less educated or the people who have not been educated at a high level. Generally labourers were mentioned, explaining how they are generally less educated in the society they are born and raised in.

Recreational purposes were also mentioned by the interviewees. Some uses these substances only for recreational purposes, either just for fun or because they do not know any different from this learned pattern they have developed over the years.

Preventative strategies

The research also developed the point that if random drug and alcohol testing was implemented, then it must be developed with an OHS management plan. The contractors that come in to work on a particular construction site must abide by the company policies and guidelines and sign under the conditions of the company. Also, in order to work coherently with the sub-contractors, two managers believe that reviewing the sub-contractors' drug and alcohol policy is important when implementing a drug and alcohol policy within the company.

The interviewees were then asked if there was any industry policy that would be implemented to reduce the use of these substances in the construction industry.

Random testing: all interviewees explained how random drug testing could be implemented throughout the organisation in an attempt to reduce the use of these substances. One manager described how there are already random drug tests for high risk work such as crane drivers. Anyone performing what is deemed to be high risk work cannot be under the influence of drugs or alcohol and they can be asked to perform mandatory drug and alcohol tests. One OHS officer also explained how they have a drug and alcohol policy in place that has a zero tolerance to these substances, but is not enforced through mandatory drug or alcohol testing yet.

Industry wide policy: all three Managers and both OHS Officers agreed that some sort of drug and alcohol testing should be introduced in the Construction Industry in order to reduce risks of injuries and death on site. An important note made by one of the OHS Officers is that the tester testing the workers should also be tested for compliance prior to implementing it as business continuity.

Zero tolerance: All interviewees agreed on a zero tolerance as it increases the safety of the workers, the organisation and the industry as a whole. However, one of the

OHS Officers made a point whereby implementing this will be difficult in the construction industry because of the strength and authority of the union.

Further, one interviewee believed that a test of impaired judgement may be more effective than zero tolerance. He mentioned “it has become part of the Australian culture to wind down at the end of the week and have a cold beer”. This was the reason their company introduced a policy, whereby an ‘impaired judgement’ test was conducted if an individual was thought to have been working under the influence of drugs or alcohol.

RECOMMENDATIONS IN THE LITERATURE

The survey results show that 60% of the respondents had some association with drugs or alcohol on site. They either noticed a co-worker to be working under the influence of drugs or alcohol at one time or another, or had themselves admitted to be under the influence of drugs or alcohol at some stage while working. In particular, the interviews conducted with industry professionals show that drug and alcohol related incidents occur on a regular basis. This result is consistent with a national survey conducted by Biggs and Williamson (2013). According to their work 58% of 494 workers surveyed scored above cut-off cumulative score for risky or hazardous alcohol use. Construction industry was also identified as an industry with high risk of drinking in the 2001 National drug strategy household survey (Berry et al 2007). Therefore, implementation of preventative measures within the industry is necessary.

Lehtola et al (2008) suggested that a multifaceted safety campaign, as well as a multifaceted drug-free-workplace program can reduce nonfatal injuries. These campaigns are part of a broad range of activities that will provide young people with information about drug and alcohol use, focusing on preventing harm for young people as they may be at risk.

Formal policies that allow drug testing are necessary for organisations to enforce random drug testing to their employees and should become part of the company policy. Companies that experienced lower rates of injuries and death had some sort of drug testing program in place (Gerber and Yacoubian 2002).

Wickizer et al. (2004) reported that a drug-free-workplace program resulted in a reduction of injuries from 29.03 persons in 100, to 20.53 persons in 100, equalling - 8.5. Formal policies and enforcement such as drug testing, worker assistance such as educating workers, supervisors and managers, as well as providing financial incentives for improving offender were key strategies.

Mandatory drug and alcohol testing is not the only solution to control substance use in the construction industry. Educational preventative programs are also needed. A severe lack of education provided to the workers about safety regulations and the Australian legislation is evident (Dingsdag et al. 2006). An educational preventative program is a solution to the drug and alcohol use on site, whereby employers, employees, clients, unions, contractors and sub-contractors need to be involved in becoming educated and engender a cultural change in the construction workforce (Biggs and Williamson 2012).

Developments of appropriate industry policies as well as a cultural change management system are also key approaches determined in order to reduce use of alcohol and other drugs in the Construction Industry (Biggs and Williamson 2012).

Stress is one factor that may lead to excessive drug and alcohol use. Excessive stress can interfere with an individual's productivity and impact both the physical and emotional status (Robinson, et al 2013). A method in ensuring the stress and anxiety at work does not lead to substance use is to implement time management tips such as a balanced life schedule, reducing over-commitment, physical exercise, adequate sleep and making the right food choices.

CONCLUSIONS

Construction industry is a major sector in the Australian economy. However, it is among top three industries with the highest rate of work related injuries and fatalities. Over the five years from 2007-08 to 2011-12 the industry accounted for 11% of all serious workers compensation claims. There are anecdotal evidences and limited research suggesting that these injuries are partly related to the alcohol and drug consumption. This research investigated the extent of this issue in a large construction project. The research was conducted through survey of 72 workers and in depth interviews with three managers and two OHS officers. It also summarised the recommended preventative strategies discussed in the literature.

The results showed that 35% of respondents at least once have seen someone on site under the influence of drug or alcohol in the last 12 months. 9 respondents reported that they have observed these incidents more than 2 times during the same period. The considerable results came out of questions asking for self-admittance. 22% of the population admitted that they have been under the influence of drug and 47% of them admitted that they have been under the influence of alcohol while at work.

According to this survey, most of the users were labourers in younger age groups. The respondents also reported seeing 6 equipment operators under the influence while at work. Subcontractors were seen 7 times under the influence. That is why one of the interviewees suggested that any preventative method should be part of OHS management plan and all subcontractors should abide by that.

Random testing particularly was in the interest of this research. Although industry practitioners believe that there will be resistant between the workers against this policy, the survey showed that 86% of the respondents had no objection to this policy.

The in depth interviews confirmed the survey results on the extent of drug and alcohol use in this industry. According to the interviewees the underlying causes are long working hours, personal stress, drinking culture, mental issues, level of education, and recreational purposes. Comprehensive OHS management plan, industry wide polices, and random testing were mentioned by the interviewees as preventative strategies. However, zero tolerance may not be applicable in the Australian construction industry because of cultural norms. Therefore, a test of impaired judgement may be an effective alternative.

This research is further evidence on the extent of drug and alcohol use in the Australian construction industry. The results are alarmingly high suggesting that any safety strategy in companies or industry policies aiming for safety improvement needs to address this problem.

LIMITATIONS

One main limitation to the research is the depth of questions that were asked in the anonymous surveys. Because drug and alcohol use is a very sensitive and personal issue, it was difficult to include further personal questions in order to gather more detailed and comprehensive data. A further limitation was the ability to survey more construction companies. Finding companies that allow such surveys is a challenge.

The result of this research is not claimed to be a representative of the whole industry. However, it can be used as an evidence for the existence of the use of drug and alcohol in the Australian construction industry.

REFERENCES

- Australian Bureau of Statistics (2012) Construction Industry 2010-11. Retrieved 06/04/2013 from
<http://www.abs.gov.au/ausstats/abs@.nsf/Lookup/by%20Subject/1301.0~2012~Main%20Features~Construction%20industry~98>
- Biggs, H. C. and Williamson, A. R. (2013) Alcohol and other drugs in the Australian construction industry: a pathway for safety focused cultural change. In Kajewski, Stephen L., Manley, Karen, & Hampson, Keith D. (Eds.) Proceedings of the 19th CIB World Building Congress, Brisbane 2013: Construction and Society, Queensland University of Technology, Brisbane, QLD.
- Biggs, H.C and Williamson A. R. (2012) Safety impacts of alcohol and other drugs in construction: development of an industry policy and cultural change management program In: Smith, S.D (Ed) Procs 28th Annual ARCOM Conference, 3-5 September 2012, Edinburgh, UK, Association of Researchers in Construction Management, 445-454.
- Berry, J.B., Pidd, K., Roche, M., Harrison, J. E. (2007) "Prevalence and patterns of alcohol use in the Australian Workforce: findings from the 2001 National Drug Strategy Household Survey", *Addiction*, 102(9), pp 1399-1410.
- Dingsdag, Donald, P and Sheahan, Vaughn L, and Biggs, Herbert, C, (2006) Safety Culture in the Construction Industry: Changing behaviour through enforcement and education? In Proceedings Clients Driving Innovation: Moving Ideas into Practice. The Second International Conference of the CRC for Construction Innovation
- Feagin, J., Orum, A., & Sjoberg, G. (Eds.). (1991). *A case for case study*. Chapel Hill, NC: University of North Carolina Press.
- Gerber, J. K., Yacoubian Jr, G. S. (2002) "An assessment of drug testing within the Construction Industry", *Journal of drug education*, 32(1), pp 53-68.
- Lehtola, M. M., Van der Molen, H. F., Lappalainen, J., Hoonakker, P. L., Hsiao, H., Haslam, R., Hale, A., and Verbeek, J. H. (2008). "The effectiveness of interventions for preventing injuries in the construction industry: a systematic review", *American journal of preventive medicine*, 35(1), pp77-85.
- Lingard, H., Cooke, T., Gharaie, E., (2013), "The how and why of plant-related fatalities in the Australian construction industry", *Engineering, Construction and Architectural Management*, 20(4), pp 365-380
- Robinson, L., Smith, M., Saisan, J. (2013). *Drug Abuse and Addiction*. [ONLINE] Available at:
http://www.helpguide.org/mental/drug_substance_abuse_addiction_signs_effects_treatment.htm#understanding. [Accessed 15 Jan 14].

Safe Work Australia (2012), Australian Work Health and Safety Strategy 2012-2022,
Available at: www.safeworkaustralia.gov.au

Wickizer, T. M., Kopjar, B., Franklin, G., & Joesch, J. (2004). Do Drug-Free Workplace Programs Prevent Occupational Injuries? Evidence from Washington State. *Health Services Research*, 39(1), 91-110.

WorkCover Corporation of South Australia (2001) Guidelines for drug, alcohol and the workplace, Adelaide, Australia

Yin, R. K. (2009). *Case study research: Design and methods* (Vol. 5). Sage.

CONSTRUCTION HAZARD PREVENTION: THE NEED TO INTEGRATE PROCESS KNOWLEDGE INTO PRODUCT DESIGN

Ron Wakefield¹, Helen Lingard¹, Nick Blismas¹, Payam Pirzadeh¹, Brian Kleiner², Thomas Mills², Andrew McCoy² and Lance Saunders³

⁵⁰ RMIT University, Melbourne, Australia

⁵¹ Virginia Tech., Blacksburg, Virginia

⁵² University of Tennessee, Knoxville, Tennessee

Social network analysis was used to model information exchange networks in construction case studies in the United States of America and Australia/New Zealand. For each case, the quality of work safety and health (WHS) risk control outcomes was measured. This measurement was based on an established “hierarchy of control” in which risk controls are classified in descending order of effectiveness. The construction contractors’ degree centrality was examined as a proxy measure of the constructors’ influence in decision making during the pre-construction stages of the project. Network metrics were compared for cases in which the risk control scores were higher and lower than average. The results showed a significant difference in constructors’ degree centrality for cases with high and low risk control efficacy scores. Constructors had significantly higher degree centrality in cases with high compared to low quality OSH risk control outcomes. The results provide preliminary evidence that integrating construction process knowledge into pre-construction decision-making produces better OSH outcomes. The research also highlights the potential usefulness of social network analysis and network metrics in OSH performance measurement and benchmarking.

Keywords: Work Safety and Health, Prevention through Design, Risk Control, Knowledge Integration, Education

INTRODUCTION

Prevention through Design (PtD)

The practice of anticipating and ‘designing out’ potential work safety and health (WHS) hazards associated with processes, structures and plant and equipment (referred to in this paper as Prevention through Design or PtD) has attracted considerable attention in recent years (Schulte, 2008). In 1992 the Council of European Communities implemented the Directive 92/57/EEC – concerning temporary or mobile construction sites. This directive required consideration of construction workers’ OSH during the design stage of construction projects. The

⁵⁰ ron.wakefield@rmit.edu.au, helen.lingard@rmit.edu.au, nick.blismas@rmit.edu.au, payam.pirzadeh@rmit.edu.au

⁵¹ bkleiner@vt.edu, thommill@vt.edu, apmccoy@vt.edu

⁵² lancewsaunders@gmail.com

United Kingdom responded to the Directive with the enactment of the *Construction (Design and Management) Regulations* in 1994 (which were revised in 2007 and are currently undergoing further review and revision). Interest in PtD in construction also spread to countries outside the European Union. In Australia legislation requiring designers of buildings and structures to consider workers' OSH has been implemented in all jurisdictions. In the United States of America, PtD is a strategic goal cited in the *National Construction Agenda for Occupational Safety and Health in the US Construction Sector* (NORA Construction Sector Council, 2008).

Implementation problems

However, commentators have identified significant implementation issues relating to PtD in the construction industry. For example, Atkinson and Westall (2010) note that many widely-cited PtD solutions, such as designing anchorage points for fall arrest devices in structures and providing guard-rails do not eliminate an inherently dangerous activity, i.e, working at height. They suggest that these PtD measures produce a modest reduction in OSH risk experienced by workers but fall short of optimizing the reduction of risk. Researchers also comment that design professionals in the construction industry (architects and engineers) possess limited knowledge of construction processes (Yates and Battersby 2003). Even in the UK, where the Construction Design and Management Regulations have been in place for some 18 years, Brace et al. (2009) report that "many designers still think that safety is 'nothing to do with me,' although there are a small cohort who want to engage and are having difficulty doing this because they do not fully understand what good practice looks like" (p. 12).

Construction projects are traditionally structured in such a way as to produce a temporal and organizational segregation between the design and construction functions. This can impede the development of shared project goals (Baiden and Price, 2011) and can negatively impact project outcomes, including those relating to OSH (Love and Gunasekaran, 1998). Even in more integrated Design and Construct projects, the design of the product to be constructed is often outsourced to a specialist team of professional designers and positive OSH outcomes are not guaranteed (Atkinson and Westall, 2010). A recent review of WHS in the UK construction industry identifies separation and poor communication between the design and construction functions as a causal factor in construction fatalities (Donaghy, 2009).

Aim

The research aimed to investigate the extent to which the integration of construction process knowledge into decision-making about the permanent design of a facility can improve OSH risk control outcomes. The research:

- Investigated the quality of OSH risk control outcomes in case study projects,
- Measured the prominence of the construction contractor in project social networks, and
- Compared the construction contractor's prominence in cases with high quality and lower quality OSH risk control outcomes.

RESEARCH METHODS

Case study design

The research adopted a comparative case study approach (Yin, 1994). Data were collected from a total of 23 construction projects, 10 in Australia/New Zealand and 13 in the United States of America. For each project, features of work were purposefully identified by project participants in consultation with the research team. Features of work were selected because they presented a particular health and safety problem or challenge.

For each feature of work, comprehensive data was collected to capture decisions that were made in relation to the design of the feature of work, the process by which it was to be constructed and the way that health and safety hazards were to be addressed. Data were collected by conducting in-depth interviews with stakeholders involved in the planning, design and construction of the selected features of work. These interviews explored the timing and sequence of key decisions about each feature of work, and the influences that were at play as these decisions ‘unfolded’ in the project context. During the course of the research 288 interviews were conducted (185 in Australia and 103 in the USA). The average number of interviews per feature of work was 6.7.

Dependent variable

Data was collected about OSH hazards and the risk control solutions implemented within the case examples. This data was elicited during the interviews and supplemented with site-based observations and examination of project documentation (e.g. plans and drawings). For each feature of work, a score was generated reflecting the quality of implemented risk control solutions. This score was based on the hierarchy of control (HOC).

The hierarchy of control (HOC) is a well-established framework in OSH (see, for example, Manuele, 2006). The HOC classifies ways of dealing with OSH hazards/risks according to the level of effectiveness of the control. At the top of the HOC is the elimination of a hazard/risk altogether. This is the most effective form of control because the physical removal of the hazard/risk from the work environment means that workers are not exposed to it. The second level of control is substitution. This involves replacing something that produces a hazard with something less hazardous. At the third level in the HOC are engineering controls, which isolate people from hazards. The top three levels of control (i.e. elimination, substitution and engineering) are technological because they act on changing the physical work environment. Beneath the technological controls, level four controls are administrative in nature, such as developing safe work procedures or implementing a job rotation scheme to limit exposure. At the bottom of the hierarchy at level five is personal protective equipment (PPE) – the lowest form of control. Although, much emphasized and visible on a worksite, at best, PPE should be seen as a “last resort,” see, for example Lombardi et al.’s analysis of barriers to the use of eye protection (Lombardi et al. 2009). The bottom two levels in the HOC represent behavioural controls that they seek to change the way people work (for a summary of the limitations of these controls see Hopkins, 2006).

Each level of the HOC was given a rating ranging from one (personal protective equipment) to five (elimination). The risk controls implemented for hazards/risks

presented by each feature of work were assigned a score on this five point scale. In the event that no risk controls were implemented, a value of zero was assigned.

Independent variable

Social network analysis (SNA) was used to map the social relations between participants involved in making design decisions about each feature of work. SNA is an analytical tool to study the exchange of resources between participants in a social network. Using social network analysis, patterns of social relations can be represented in the form of visual models (known as sociograms) and described in terms of quantifiable indicators of network attributes. In a sociogram, participants are represented as nodes. To varying extents, these nodes are connected by links which represent the relationships between participants in the network.

SNA has been recommended as a useful method for understanding and quantifying the roles and relationships between construction project participants (Pryke, 2004; Chinowsky et al. 2008). The technique has been used to analyse knowledge flows between professional contributors to project decision-making (see, for example, Ruan et al. 2012; Zhang et al. 2013). Network characteristics have also been used to explain failures in team-based design tasks (Chinowsky et al. 2008) and identify barriers to collaboration that arise as a result of functional or geographic segregation in construction organizations (Chinowsky et al. 2010). More recently, Alsamadani et al. (2013) used SNA to investigate the relationship between safety communication patterns and OSH performance in construction work crews.

In order to gauge the construction contractor's prominence in a project social network, the contractor's degree centrality was calculated. Degree centrality refers to the extent to which one participant is connected to other participants in a network. Thus, degree centrality is the ratio of the number of relationships the actor has relative to the maximum possible number of relationships that the network participant could have. If a network participant possesses high degree centrality then they are highly involved in communication within the network relative to others. Pryke (2005) argues that degree centrality is a useful indicator of power and influence within a network.

Degree centrality can be measured by combining the number of lines of communication into and out of a node in the network (see, for example, Alsamadani et al., 2013). This presents an aggregate value representing the participant's communication activity. However, the independent variable used in this research was calculated using only the construction contractors' outgoing communication. This was a deliberate choice because the research aim was to investigate whether OSH risk control is of a higher quality when project decisions are made with due consideration of construction process knowledge. Thus, the flow of communication from the construction contractor to other network members was deemed to be of greater relevance than the volume of information they received.

RESULTS

The sample

Multiple features of work were selected from each construction project and the total number of features of work in the analysis was 43. The number of features of work from each construction projects ranged between 1 and 4 and the mean number was 1.9.

Features of work were drawn from the heavy engineering (39.6%), commercial (20.9%), industrial (27.9%) and residential (11.6%) sectors of the construction industry. The majority of cases were collected in projects procured using a Design and Build delivery mechanism (34.9%). Twelve cases (27.9%) were collected in accelerated project delivery arrangements. Nine cases (20.9%) were drawn from projects procured using a traditional (Design-Bid-Build) delivery method and seven cases (16.3%) were collected in projects using a collaborative delivery method.

Inter-rater reliability

To ensure that the coding of OSH risk control measures was consistent between the US and the Australian research teams, an inter-rater reliability assessment was performed. A list of OSH hazards and risk controls from one case were sent from the Australian to the US research team (and vice versa). Each group then rated the others' sample data using the HOC classification method. The US raters' HOC classification was consistent with the Australian research team classifications in 12 of 14 Australian cases (85.7%). The Australian raters' HOC classification was consistent with the US research team classifications in 9 of the 10 US cases (90%). Additionally, Cohen's Kappa was calculated for both of the samples. The values of Kappa for the AU and US samples were 0.75 and 0.81 respectively. The high level of agreement suggests that the HOC classification method was applied consistently between the two countries.

Comparison of means

Table 1 shows the mean HOC scores for cases by industry sector, project type and country. Australian cases in the analysis had higher average HOC scores than were evident in the US cases. Further, the difference between mean HOC scores between the US and Australian cases was found to be statistically significant ($t=7.731$, $p=.000$). Cases drawn from collaborative or design and build projects had slightly higher HOC scores than cases drawn from accelerated (fast track) or design-bid-build projects. Cases drawn from the commercial and residential sectors had lower mean HOC scores than cases drawn from the engineering and industrial construction sectors. However the differences in HOC scores did not differ significantly by delivery method or industry sector.

Table 1: Mean HOC scores by country, project delivery method and industry sector

Case descriptor	Mean HOC score	Standard deviation
<i>Country</i>		
United States	2.48	.311
Australia	3.69	.671
<i>Delivery method</i>		
Collaborative	3.36	.632
Accelerated	2.98	.820
Design-bid-build	2.71	.602
Design and Build	3.38	.233
<i>Sector</i>		
Heavy engineering	3.33	.844

Residential	3.02	.777
Commercial	2.72	.649
Industrial	3.13	.807

Table 2 shows the results of the comparison of mean social network values between cases with the highest and lowest HOC scores. Constructors' degree centrality was higher in cases with more positive HOC outcomes. This was the case for the constructor's degree centrality measured across the project as a whole, as well as the constructor's degree centrality relating to only the pre-construction (i.e, planning and design) stage. In both cases, the independent samples t-tests revealed these differences to be statistically significant.

Table 2: Comparison of cases with low versus high HOC mean scores

Variable	HOC grouping	Mean	t	Significance (p)
Constructor's Normalised degree Centrality (pre-construction stage)	High HOC	14.193	3.636	.022
	Low HOC	5.377		
Constructor's Normalised degree Centrality (whole project)	High HOC	16.080	3.148	.035
	Low HOC	9.103		

Case example: Design and construction of steel columns and roof structure at a food processing and storage facility

An initial concept design was developed on behalf of the client to accommodate operational requirements for the facility. The concept design included a steel framed structure consisting of three spine trusses supported by five rows of steel columns. To maximise useable floor space, the columns were positioned in the middle of product stacks rather than at the ends of the rows.

The Design and Construction contractor suggested eliminating one row of columns. This design alternative required fewer columns to be lifted and manoeuvred into place, reducing the duration of exposure to OSH risks associated with lifting operations. The contractor also suggested revisions to the roof design, suggesting the use of trussed rafters connecting to the main spine trusses instead of using steel beams as rafters. The fabrication of rafter trusses was slightly more expensive, but these trusses weighed less than steel beams and could be manufactured off-site. The reduced weight of the roof enabled the use of smaller sections for supporting columns. It also made the erection and installation of the roof quicker and easier.

All supporting columns were fitted with a bearing plate allowing trusses to be temporarily supported while connections at each end were bolted. This reduced the need for propping and manual handling associated with installing and dismantling props and also freed the area around the columns and under the trusses of any obstacles or trip hazards that may have been caused by props. At the same time, this design solution reduced the extent of work required at height to connect the trusses to

the columns and reduced the OSH issues associated with suspended loads. As the client's engineer commented:

"[The constructor has] got quite a good, what I call a bearing type detail, so you can actually put the trusses up and have them take the gravity load away before you start trying to put the bolts in. And that's one of the major concerns [on another similar project] is that we should have picked it up when we did the structural check, but of course we just checked the structure rather than checking the buildability."

The structure was designed so that erection could be done in self-supporting sections. This allowed the builders to start at one end of the building and move progressively along the length of the building. Using this method, the constructor was able to ensure that crane lifts were within safe reach tolerances, without having to extend the cranes arm over already constructed portions of the structure. To ensure the constructability of the facility before the start of construction work, the main constructor involved subcontractors in reviewing the design and erection/installation sequences. The resulting PtD solutions resulted in an HOC score of 4.2.

Figure 1 shows the pre-construction social network for this project. The data revealed a relatively high normalized degree-centrality (14.46) for the constructor. As the sociogram depicts, the construction contractor had direct links with the majority of other network participants. The network pattern shows that the constructor took advantage of direct information ties with suppliers and sub-contractors (steel erectors and concreters). These suppliers/subcontractors possess practical knowledge about constructability issues and would be responsible for executing the construction tasks. Their engagement in decision making enabled the constructor to benefit from their specialised knowledge in proposing practical and safer design solutions which, in turn, improved the quality of OSH risk control.

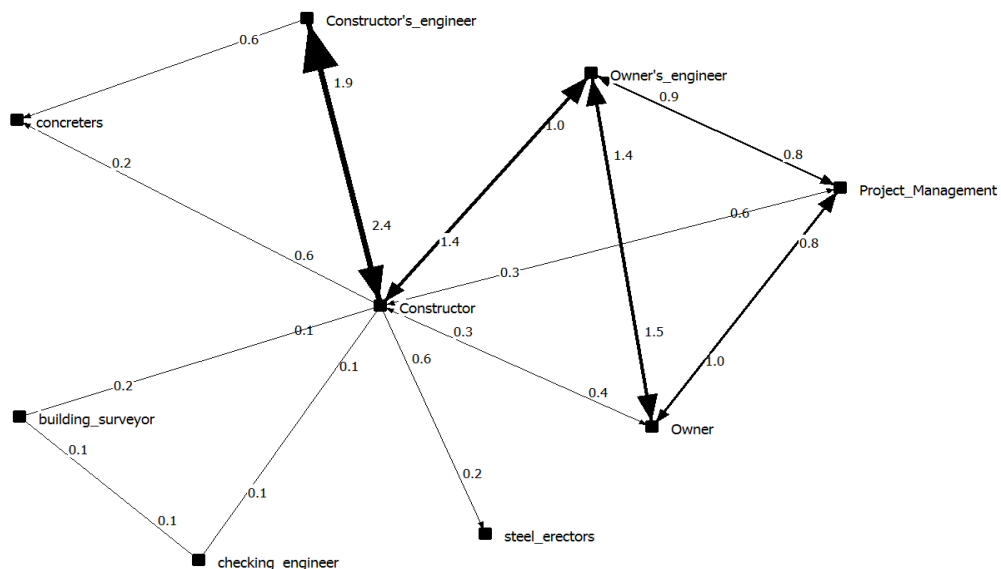

Figure 1: Sociogram for the steel structure design at a food processing and storage facility

On the right hand side of the sociogram are key “demand-side” stakeholders, including the owner, owners’ engineer and project manager. On the left side of the network are key “supply –side” stakeholders, including the concreters and steel

erectors. Also to the left of the network are stakeholders who supply design related information and services to the network (i.e, the checking engineer and building surveyor). The Design and Construction contractor is the central actor connecting these three groups. In this central position, the contractor was able to identify constructability issues before construction commenced and drive the redesign of various components, which still met the owner's operational requirements for the facility and complied with regulatory requirements.

DISCUSSION

The importance of construction process knowledge

The research provides preliminary empirical evidence that the integration of construction process knowledge in design decision-making, as evidenced by information flowing from the construction contractor to other project participants, is linked to the adoption of more effective OSH risk control solutions.

The t-tests revealed a significant difference in the constructors' degree centrality values between cases with above and below average HOC scores. These findings do not indicate a causal relationship, but do suggest that knowledge of construction processes is an important and valuable resource that can support the adoption of preferred technological controls for OSH risks. Compared to other project participants, construction contractors have a high level of construction expertise because of their specialized training and experience in the application of construction materials and methods. Constructors are arguably in the best position to provide advice about OSH hazards/risks and ways to mitigate them in construction activities. Construction contractors are also responsible for construction operations and have a strong motivation and interest in ensuring work can be performed with minimal risk to OSH (Song et al. 2009).

Integrating mechanisms

The results highlight the potential OSH benefit to be gained by integrating construction process knowledge into the design of facilities to be constructed. Unfortunately the fragmented and sequential nature of design and construction work inherent in construction projects militates against this integration. Integrated project delivery methods may increase the extent that process knowledge is used to inform product design in construction projects. However, the fact that no significant differences were found between the HOC scores for cases drawn from projects procured in different ways suggests that collaborative forms of project delivery do not guarantee better OSH outcomes will be realized. There is also potential to improve OSH outcomes through the adoption of concurrent engineering (CE). CE is characterised by a unified development process and a multidisciplinary project delivery team and has been proposed as a technique to improve construction productivity (Love and Gunasekaren, 1997). Another key feature of CE is the concurrency or overlapping of activities. The integration of product and process design has been recommended as a means to improve construction project performance (Anumba et al. 2000). The research results suggest that simultaneous consideration of product and process design could produce significant improvement in the quality of ways in which OSH risks are controlled.

Implications for education

The research has important implications for the education of construction industry professionals, particularly those involved in “upstream” decision-making. Design professionals’ low levels of process knowledge has been cited as a barrier to the effective implementation of PtD in the construction industry. In the UK, following her review of construction fatalities, Donaghy (2009) recommended accrediting bodies representing the construction professions establish specific requirements to include OSH in the education of all professionals engaged in the delivery of construction projects. Specific requirements to incorporate construction process knowledge into the engineering and architecture curricula could enhance the effectiveness of PtD policy initiatives.

Quality of risk control as a measure of OSH effectiveness

The research also developed a new method for measuring OSH performance in research. Commonly used measures, e.g. the frequency or rate of occurrence of accidents, are notoriously unreliable measures of safety performance in construction projects. Thus, using accident occurrence as a dependent variable in research is problematic. The use of the HOC provides a more direct and useful measure of the quality of OSH risk mitigation efforts and more directly measures the quality of OSH outcomes. Thus, we propose using the HOC as a valid “leading indicator” of OSH performance in future research.

CONCLUSIONS

The failure to address OSH in design is at odds with contemporary thinking in OSH risk management, in which the most effective means of dealing with a hazard is to eliminate it at source. There is compelling evidence to suggest that decisions made during the design stage of a project can have a significant “downstream” impact upon OSH. However, research suggests structural and practical impediments to the effective implementation of PtD in construction projects. The research provides evidence that the integration of process knowledge into product design decisions can significantly improve the quality of OSH risk control in construction. It is recommended that project participants consciously adopt project delivery and management strategies that will support this integration. In addition, the research suggests that the provision, through curriculum change, of construction process knowledge to designers of the constructed product (i.e. engineers and architects) could also help to optimize OSH risk control outcomes.

REFERENCES

- Alsamadani, R., Hallowell, M., Javernick-Will, A., (2013), Measuring and modelling safety communication in small work crews in the US using social network analysis, *Construction Management and Economics*, 31, (6), 568-579
- Anumba, C., Baldwin, A. N., Bouchlaghem, D., Prasad, B., Cutting-Decelle, A. F., Dufau, J. and Mommessin, M., (2000), Integrating concurrent engineering concepts in a steelwork construction project, *Concurrent Engineering*, 8 (3), 199-212.
- Atkinson, A. R. and Westall, R., (2010), The relationship between integrated design and construction and safety on construction projects, *Construction Management and Economics*, **28**, 1007–1017.
- Baiden, B., K. and Price, A. D. F., (2011), The effect of integration on project delivery team effectiveness, *International Journal of Project Management*, 29, 129-136.

- Brace, C., Gibb, A., Pendlebury, M., and Bust, P., (2009), *Health and safety in the construction industry: Underlying causes of construction fatal accidents – External research*, Secretary of State for Work and Pensions, Inquiry into the underlying causes of construction fatal accidents, Loughborough University, Loughborough,
- Chinowsky, P., Diekmann, J. and Galotti, V. (2008), Social network model of construction, *Journal of Construction Engineering and Management*, 134 (10), 804-812.
- Chinowsky, P., Diekmann, J. and O'Brien, J., (2010), Project organizations as social networks, *Journal of Construction Engineering and Management*, 136, (4), 452-458.
- Donaghy, R., (2009), *One death is too many: Inquiry into the underlying causes of construction fatal accidents*, Report to the Secretary of State for Work and Pensions, Crown Copyright, Office of Public Information, Richmond.
- Franz, B. W., Leicht, R. M. and Riley, D. R., Project Impacts of Specialty Mechanical Contractor Design Involvement in the Health Care Industry: Comparative Case Study, *Journal of Construction Engineering and Management*, 139 (9), 1091-1097.
- Gangoellis, M., Casals, M., Forcada, N., Roca, X. and Fuertes, A., (2010), Mitigating construction safety risks using prevention through design, *Journal of Safety Research*, 41, 107-121.
- Hopkins, A., (2006), What are we to make of behavioural safety systems, *Safety Science*, 44, 583-597.
- Lombardi, D. A., Verma, S. K., Brennan, M. J. and Perry, M. J., (2009), Factors influencing worker use of personal protective eyewear, *Accident Analysis and Prevention* 41, (4), 755-762.
- Love, P. and Gunasekaran, A. (1997), Concurrent engineering in the construction industry, *Concurrent Engineering*, 5(2), 155-162.
- Love, P., Gunasekaran, A. Love, P., Gunasekaran, A. and Li, H., (1998) Concurrent engineering: a strategy for procuring construction projects. *International Journal of Project Management*, 16(6), 375–83.
- Manuele, F. A. (2006) Achieving risk reduction, effectively, *Process Safety and Environmental Protection*, 84(B3), 184–190
- National Occupational Research Agenda Construction Sector Council, (2008), *National Construction Agenda for Occupational safety and Health Research and Practice for the U.S. Construction Sector*, Centres for Disease Control and Prevention/NIOSH, Atlanta.
- Pryke, S. D., (2004), Analysing construction project coalitions: exploring the application of social network analysis, *Construction Management and Economics*, 22, 787-797.
- Pryke, S. D., (2005), Towards a social network theory of project governance, *Construction Management and Economics*, 23, (9), 927-939.
- Ruan, X., Ochieng, E. G., Price, A. D. F. and Egbu, C. O., (2012), Knowledge integration process in construction projects: a social network analysis approach to compare competitive and collaborative working, *Construction Management and Economics*, 30 (1), 5-19.
- Schulte, P.A., Rinehart, R., Okun, A., Geraci, C.L., and He, D.S. (2008), National Prevention through Design (PtD) Initiative, *Journal of Safety Research*, Vol. 39 No. 2, 115-121.

- Song, L., Mohamed, Y. and AbouRizk, S. M. (2009), Early contractor involvement in design and its impact on construction schedule performance, *Journal of Management in Engineering*, 25(1), 12-20.
- Yates, J. K. and Battersby, L. C. (2003), Master builder project delivery system and designer construction knowledge, *Journal of Construction Engineering and Management*, 129(6), 635-644.
- Yin, R.K. (1994), *Case Study Research: Design and Methods 2nd Ed.* London: Sage Publications Ltd.
- Zhang, L., He, J. and Zhou, S. (2013), Sharing tacit knowledge for integrated project team flexibility: Case study of integrated project delivery, *Journal of Construction Engineering and Management*, 139 (7), 795-804.

Quality work life

THE IMPACT OF ANNUAL EMPLOYEE MEDICALS ON A GENERAL CONTRACTOR (GC) AND ITS EMPLOYEES' SUSTAINABILITY

Professor J.J Smallwood ⁵³ and Claire Deacon ²

¹ *Department of Construction Management, Nelson Mandela Bay Metropolitan University, Port Elizabeth, South Africa*

² *OCCUMED cc, P O Box 40108, Walmer, Port Elizabeth, South Africa*

Contractors are not required to provide organisation wide annual medicals in South Africa. However, better practice and the optimisation of the health and wellbeing of employees allude to the importance of such annual medicals. Human resources entail much expense through, inter alia, training and development and thus their sustainability is important. Furthermore, anecdotal evidence indicates that a degree of cynicism exists with respect to the merits of such annual medicals. Given the aforementioned, a study was conducted within a 'better practice' GC to determine the impact and merits of such annual medicals.

Employees of a 'better practice' GC in South Africa were surveyed using a self-administered questionnaire subsequent to being medically examined.

Findings in terms of the impact of such medicals include: the medicals are important to employees and their families, and the medicals are perceived as important to the GC, its human resources management, and health and safety (H&S) management.

Other findings include that the medicals: increased employees' awareness of general and specific health issues; enhanced employees' health and wellbeing and self-esteem; contributed to a reduction in the frequency of ill health and personal absenteeism, and contributed to an improvement in personal productivity.

The impact of the medicals underscores the need for contractor H&S programmes to focus on the health and wellbeing of all employees. Furthermore, the findings constitute the first of their kind and reinforce the decision by the management of the GC to provide such annual medicals at their own expense, and also to focus on the health and wellbeing of their employees as part of their H&S programme and sustainable employment initiative.

Keywords: Benefits, Construction, Health and Wellbeing, Medicals, Sustainability.

INTRODUCTION

'Work' defines a person, and is described as an activity that involves mental and / or physical effort; performed to achieve a particular set of results (Acutt 2011, Snashall 2012). It is widely considered that work is good for one, and that a healthy working population is good for a country's economic and social development. However, certain types of work have the converse effect, and affect the fitness for work and impacts on personal health levels (Snashall & Patel 2012, Williams 2012). Absenteeism and ill-health are, sadly, synonymous with work, and is a costly result of poor health, work related or not. In many countries the actual costs, absenteeism and

⁵³ John.smallwood@nmmu.ac.za

early retirement levels are largely unknown (Brenner and Ahern 2000, Snashall 2012). The burden of disease, particularly occupationally related is enormous. The International Labour Organisation (ILO) cite 6 300 people as dying daily, 2.3 million deaths annually, and 337 million people off work, injured or ill as a result of occupational accidents or work-related exposure. The burden is particularly heavy in developing countries, where, for example, the death rate in construction is known to be 10 times higher than in developed countries (Snashall 2012).

LITERATURE REVIEW

Contractors are not required to provide organisation wide annual medicals as part of a formal medical surveillance programme in South Africa. However, better practice and the optimisation of the health and wellbeing of employees allude to the importance of such annual medicals and formal occupational health (OH) programmes. The overall practice of providing medical surveillance is common, and generally well managed in general industry, but is not pervasive in the construction sector. Issues in the construction sector lead to the perception that medicals and general surveillance are difficult to manage. Such issues include, inter alia, the peripatetic nature and varying duration of projects, high turnover of construction workers, the use of contractual labour, and a lack of OH services in the sector (Deacon, von der Marwitz, Smallwood, and Lapere 2004).

Historically, less effort is directed towards health issues in the construction sector (Deacon *et al.* 2004). One of the most obvious effects of health improvement on the working population are the reduction in lost working days due to sick leave and an increase in productivity. Stakeholders in the construction sector need to conceptualise possible intervention strategies for improving the wellbeing of all construction workers. This would contribute to their improved work performance and a reduction in absenteeism or lost-days (Haupt, Smallwood, Tjihuis, Deacon, & Major 2003).

Existing requirements relating to medical surveillance

The Occupational Health and Safety Act (OHSA), No 85 of 1995 (Republic of South Africa (RSA) 1995), and its Regulations, provide a broad legal framework for all sectors of the South African economy. H&S legislation in South Africa requires all organisations, as employers, to identify the health risks to which workers are exposed, and manage the risk accordingly (RSA 1995). The Construction Regulations (CRs) applicable at the time of the data collection were specific in terms of screening workers who worked at heights and plant operators (RSA 2003).

Medical surveillance and OH practices

Occupational health is simply defined by the WHO, as the promotion and maintenance of the highest degree of physical, mental and social wellbeing of workers in all occupations. Medical surveillance is defined as the ongoing systematic collection, analysis, and interpretation of health and exposure data (Deacon *et al.* 2004). Medical surveillance may be required at various times, and Davies (2012) lists the occasions when medicals could be required, namely: pre-placement; job transfer / redeployment; routine surveillance for high risk work; during or after sickness absence; H&S concerns; statutory requirements; performance issues, and to identify adjustment needs. Acutt (2011) cites Gardner and Taylor, who state that the objectives and responsibilities of an OH service can only be as good or as bad as whatever services a business provides. Successful programmes should be based on a sound

philosophy of health promotion, organisational needs, and identified health needs of the workers.

The principles of OH are embedded in the 'health for all (HFA)' concept adopted and published as a declaration by the World Health Organization (WHO) (1994). The HFA states that H&S at work is an important matter, and the general health and wellbeing of workers should be given due consideration at multiple levels. OH services should be multi-disciplinary and preventative in nature, and where appropriate, include curative and health promotion elements.

Occupational Health in Construction

There is a paucity or very little evidence of literature pertaining to South African OH interventions. Little is known about OH in the South African construction industry. Health care is perceived to be the provision of primary health care and first aid services to workers (Smallwood and Ehrlich 2001). The literature further indicates that it is mostly workers, and not the senior or professional employees that attend medical surveillance. Deacon *et al.* (2004) cite a number of South African studies where it was determined that a relatively low number of GCs conduct any form of medical surveillance to determine the existence and development of occupational diseases (OD). A study conducted among members of the South African Federation of Civil Engineering Contractors (SAFCEC) determined that health specific actions by their members were virtually zero, 55.6% never conducted pre-employment medicals, and 61.1% never conducted exit medicals.

Work and Wellbeing

Interest in the wellbeing of workers is increasing. The notion of good health, working conditions and access to services is noted by Williams (2012), yet remains an imprecise term, possibly as individuals' lives have multiple dimensions. The cause and effect relationship between physical hazards and injury is far easier to understand than the holistic or biopsychosocial approach needed to address a highly complex issue of health, work and wellbeing (Adishes 2012).

RESEARCH METHOD

Study objectives

The objectives of the study were to determine, inter alia: the importance of medicals to the various stakeholders, the extent to which medicals have impacted on various aspects; the purpose of the medicals, and the reason the company conducted the medicals.

Research method and sample stratum

The design was adapted so that the perceptions of a South African GCs employees' that had been subjected to annual medicals could be determined. Sixty-one (61) employees responded to the self-administered questionnaire. Given that all responded, the response rate equates to a 100%.

Analysis

The analysis of the data consisted of the calculation of descriptive statistics to depict the frequency distribution and central tendency of responses to fixed response questions to determine the extent of impact, and the degree of importance.

A close ended question with a five-point Likert scale, which also included an ‘unsure’ response option was used. Therefore, to rank fixed response items according to the central tendency of responses, mean scores (MSs) were calculated as follows:

$$MS = \frac{1n_1 + 2n_2 + 3n_3 + 4n_4 + 5n_5}{n_1 + n_2 + n_3 + n_4 + n_5}$$

The variables are referenced in Table 1.

Table 1: Definition of five-point Likert scale points and related variables

Likert scale point	Variable
Not	n ₁
Less than important	n ₂
Important	n ₃
More than important	n ₄
Very important	n ₅

However, a six-point Likert scale, which also included a ‘did not’ response option was used. In this case, MSs were calculated as follows:

$$MS = \frac{0n_0 + 1n_1 + 2n_2 + 3n_3 + 4n_4 + 5n_5}{n_0 + n_1 + n_2 + n_3 + n_4 + n_5}$$

The variables are referenced in Table 2.

Table 2: Definition of six-point Likert scale points and related variables

Likert scale point	Variable
Did not	n ₀
Minor extent	n ₁
Near minor extent	n ₂
Some extent	n ₃
Near minor extent	n ₄
Major extent	n ₅

Findings

Respondents were required to indicate their highest qualification. Analysis of the qualifications of respondents indicates that Grade 12 (41.8%), the highest level of secondary school education, predominates in terms of qualifications of respondents, followed by ‘other’ (38.2%), and then National Diploma (18.2%). ‘Other’ includes other than Grade 12, National Diploma, BTech, BSc, and BSc (Honours).

Respondents were then required to indicate their occupations. Respondents recorded a wide range of occupations that include, inter alia, management, supervisors, skilled and unskilled workers, students and Human Resources (HR). The range of

occupations is an indication that the organisation provides all employees with medicals, not only those traditionally selected doing physical labour or work that entails statutory required medicals.

Respondents were then required to indicate the length of time they have worked for their current employer. 41.6% of respondents have worked for their current employer for more than five years, 30% for more than a year, but not more than five years, and 28.3% for a year or less. Many GCs state that short-term employment and high labour turnover creates great difficulty in providing regular primary health services. However, these findings indicate that 71.6% have worked for their current employer for more than a year, which indicates a degree of permanency and retention.

Respondents were also required to indicate the length of time they have worked in construction. 56.9% of respondents have spent more than 5 years working in construction, 29.3% more than a year, but not more than five years, and 13.8% for a year or less.

Respondents were then required to indicate the number of medicals they have been subjected to while working for their current employer and while working in construction. The total number of medicals respondents had while working for their current employer is 174, which equates to an average of 3 per respondent. A total of 43 respondents (to the question) indicated that they had been subjected to medicals while working in construction. This equates to a total of 128 medicals and an average of 2.98 per respondent. Unfortunately there is no cross-correlation to indicate which of the respondents had had multiple medicals, length of employment, while working for the organization.

Respondents were then required to record the year of their first medical while in the employ of their current employer. 40.4% of respondents' first medical was conducted between 2007 and 2009, 38.5% during 2010 or thereafter, and 19.2% between 2004 and 2006. The findings thus indicate that the organisation has been exceeding minimum statutory requirements relative to medical surveillance, which is attributable to the focus being on primary health care.

The first non-demographics question required respondents to indicate the importance of medicals to the stakeholders related to the medicals on a scale of 1 (not important) to 5 (very important), and a MS ranging between 1.00 and 5.00. It is notable that all the MSs in Table 3 are above the midpoint score of 3.00, which indicates that in general the respondents deem the medicals as more than important, as opposed to less than important.

However, given that all the MSs are $> 4.20 \leq 5.00$, the respondents can be deemed to perceive the medicals to be between more than important to very / very important to all the stakeholders. The respondents (You) (MS = 4.75) are ranked first, followed closely by the other stakeholders. The importance to the three categories of organisational management is notable.

Table 3: Degree of importance of medicals to the stakeholders related to the medicals

Stakeholder	Response (%)						MS	Rank
	U	Not..... Very						
		1	2	3	4	5		
You	1.8	1.8	1.8	3.5	5.3	86.0	4.75	1
Company management	1.8	1.8	1.8	5.4	7.1	82.1	4.69	2
Company H&S management	1.8	1.8	0.0	5.3	17.5	73.7	4.64	3
Medicals service provider	5.4	1.8	0.0	7.1	12.5	73.2	4.64	4
Company HR management	1.8	0.0	0.0	9.1	18.2	70.9	4.63	5
Your family	1.8	1.8	0.0	7.0	26.3	63.2	4.52	6

The next question required respondents to indicate the extent to which the medicals have impacted on various aspects on a scale of 'did not' and 1 (not important) to 5 (very important), and a MS ranging between 0.00 and 5.00. It is notable that all the MSs in Table 4 are above the midpoint score of 2.50, which indicates that in general the respondents deem the medicals to have made more of a major than a minor impact.

Table 4: Extent to which the medicals have impacted on various aspects

Aspect	Response (%)							MS	Rank
	U	Did not	Minor..... Major						
			1	2	3	4	5		
Your awareness of specific health issues	0.0	1.7	3.4	0.0	3.4	24.1	67.2	4.47	1
Your awareness of general health issues	0.0	1.8	1.8	0.0	7.0	26.3	63.2	4.44	2
Perception of company as an employer	0.0	1.8	1.8	3.5	14.0	15.8	63.2	4.30	3
Personal health and well being	0.0	3.5	0.0	1.8	12.3	26.3	56.1	4.26	4
Self-esteem	0.0	7.0	0.0	5.3	12.3	17.5	57.9	4.07	5
Productivity of work	1.8	10.9	1.8	1.8	12.7	16.4	54.5	3.89	6
Work attendance	1.8	17.5	1.8	3.5	8.8	10.5	56.1	3.64	7
Frequency of ill health	1.8	14.0	14.0	3.5	15.8	10.5	40.4	3.18	8

The top four (50%) ranked aspects have MSs $> 4.17 \leq 5.00$, which indicates that the medicals have had between a near major to major / major impact on the aspects: your awareness of specific health issues; your awareness of general health issues; perception of the organization as an employer, and personal health and wellbeing. The 5th to 7th (37.5%) ranked MSs $> 3.34 \leq 4.17$, indicates that the impact is between

some extent to a near major / near major extent: self-esteem; productivity of work, and work attendance. The MS of frequency of ill health falls within the MS range

$> 2.51 \leq 3.34$, which indicates a near minor impact to some impact / some impact. The ranking and MSs of your awareness of specific health issues, your awareness of general health issues, and personal health and wellbeing confirm the personal benefits accruing from the medicals. This is also the case with respect to self-esteem, even though the MS is slightly lower than 4.20, the lower point of the uppermost MS range. Frequency of ill health is yet a further personal benefit, even though the MS is $> 2.51 \leq 3.34$. Perception of company as an employer, productivity of work, work attendance, and frequency of ill health confirm the organisation benefit accruing from the medicals. The latter three have a direct impact in terms of production, whereas perception of company as an employer is image related and positively affects internal public relations.

Respondents were also posed an ‘open ended’ question: “In your opinion, what is the purpose of the medicals?” The responses presented in Table 5 indicate that H&S management (69%) predominates, followed distantly by the other purposes.

Table 5: Respondents’ perceptions regarding the purpose of organizational medicals

Purpose	Response (%)
H&S management	69.0
Productivity management	15.0
Creation of awareness	13.0
Employer’s wellness programme	10.0
Regulations compliance	7.0

Respondents were also requested to provide comments regarding medicals in construction. These are:

- “There’s a lack of service providers in rural areas. Different service providers tend to offer different feedback”;
- “Some service providers utilised for medicals do not actually have a medical background”;
- “The service providers utilised need to be recognised / accredited”;
- “Regular check-ups have improved the health and wellbeing of employees”;
- “Medicals in construction are important”;
- “Medicals should extend to the workers’ families”;
- “Besides the need of medicals being more private and extensive, the results are usually returned after a long period of time”, and
- “Attention is not given to health issues workers generally face such as ergonomics”.

The comments further reinforce the importance of the medicals to employees, and also a need for a review of the work that workers in particular undertake. The latter indicates and confirms the degree of overlap between occupational and primary health issues. Then, clearly the integrity of the providers of the medicals is being questioned.

CONCLUSIONS

The medicals are perceived to be important to all the stakeholders related to the recipients of the medicals, including the recipients, the organisation's management, organisation's H&S management, organisation's HR management, medicals service provider, and the recipients' families. Therefore, it can be concluded that the medicals have a wide ranging impact in terms of stakeholders.

The medicals have had a major as opposed to a minor impact on a range of aspects. These include awareness of specific and general health issues, perceptions of the organisation as an employer, personal health and well-being, self-esteem, productivity of work, work attendance, and frequency of ill health. Therefore, it can be concluded that medicals have a major role to play in terms of the maintenance of human resources, internal public relations, employee's health and well-being, overall performance within the organisation, and the image of the organisation.

Organisations reap further benefits when workers are treated equally, all levels of workers attend medical surveillance, irrespective of their level within the organisation. Labour turnover, furthermore can be kept to a minimum and therefore routine medical surveillance programmes can be implemented and maintained. Mobile service providers are available, and standards do exist in terms of professional and statutory requirements for professional OHPs, therefore the procurement process should assure that only accredited medicals service providers are appointed.

REFERENCES

- Acutt, J (2011) An overview of occupational health. In: J Acutt and S Hattingh (eds.) "Occupational Health management and practice for health practitioners". 4ed. Cape Town: Juta Publishers.
- Adishes, A (2012) Practising Occupational Health. In: D Snashall and D Patel (eds.) "ABC of Occupational and Environmental Medicine". 3ed. Oxford: Wiley Blackwell Publishers.
- Brenner, H and Ahern, W (2000) Patterns of Ill-Health in Irish Construction Workers. Dublin: The Construction Employees Health Trust.
- Davies, W (2012) Fitness for work. In: D Snashall and D Patel (eds.) "ABC of Occupational and Environmental Medicine". 3ed. Oxford: Wiley Blackwell Publishers.
- Deacon, C (2004) "The health status of construction workers" Magister Curationis (MCur). Unpublished Masters Dissertation. Faculty of Health Sciences. University of Port Elizabeth.
- Haupt, T, Smallwood, J, Tjihuis, W, Deacon, C, Major, V (2003) The Health and well-being of older workers in the construction industry". Unpublished Research proposal.
- Republic of South Africa (1995) The Occupational Health and Safety Act. No. 85. Pretoria.
- Republic of South Africa (2003) Construction Regulations. Regulation R. 7721 in terms of the Occupational Health and Safety Act (Act No. 85 of 1993). Pretoria.
- Smallwood, J and Ehrlich, R (2001) Occupational health in the South African construction industry: Management and worker perceptions. "African Newsletter on Occupational Health and Safety", 11(1), 10-12.
- Snashall, D. & Patel, D (2012) Preface. In: D Snashall and D Patel (eds.) "ABC of Occupational and Environmental Medicine". 3ed. Oxford: Wiley Blackwell Publishers.

- Snashall, D. (2012) Hazards of Work. In: D Snashall and D Patel (eds.) "ABC of Occupational and Environmental Medicine". 3ed. Oxford: Wiley Blackwell Publishers.
- South African Society of Occupational Health Nurses (SASOHN) (2009) Position Paper: Medical Certificate of Fitness.
- Williams, N (2012) Health, Work and Wellbeing. In: D Snashall and D Patel (eds.) "ABC of Occupational and Environmental Medicine". 3ed. Oxford: Wiley Blackwell Publishers.
- World Health Organization (WHO) (1994) Declaration on Occupational Health for All. Geneva.

Reactive health and safety

THE COSTS OF CONSTRUCTION SITE ACCIDENTS TO AUSTRALIA'S BUILDING CONTRACTORS

Yingbin Feng⁵⁴, Peng Wu⁵⁵, Xiaohua Jin⁵⁶, Jian Zuo⁵⁷

¹ *University of Western Sydney, Locked Bag 1797, Penrith NSW 2751, Australia*

² *Central Queensland University, Rockhampton, QLD 4701, Australia*

³ *University of Western Sydney, Locked Bag 1797, Penrith NSW 2751, Australia*

⁴ *University of South Australia, Adelaide, South Australia 5000 Australia*

Abstract: Problem: Occupational accidents may incur considerable financial losses for companies. Purpose: The purpose of this study was to investigate the losses incurred by building contractors in Australia due to construction workplace accidents. Method: The research aim was achieved using a case study approach. A reputable Australian contracting firm, Kell & Rigby was the subject of the case study. Twenty-seven accidents were recorded at Kell & Rigby during the year 2011. The financial costs related to the twenty-seven accidents were estimated and recorded using a validated data collection instrument. The intangible costs incurred by the accidents were assessed by interviewing the top management personnel. Findings: The results show that the tangible costs and intangible costs of accidents account for 0.55% and 0.19% respectively of the company's 2011 annual turnover, or 11% and 3.8% respectively of the company's profit margin in 2011. The findings indicate that the costs of workplace accidents are significant as the total costs accounted for more than 14% of the company's profit margin in 2011. The results may be helpful for Kell & Rigby to take efforts to improve its safety performance. The methodology of this research may be useful for a similar study conducted with different companies.

Keywords: accident; construction; building contractor; costs; workplace safety.

INTRODUCTION

Various losses would be incurred by the injured worker(s) after the occurrence of a workplace accident. These losses may include costs to victims and their families, to employers and to society (Davies and Teasedale, 1994). It was estimated that the economic cost of workplace accidents was \$57.5B in 2005/2006 financial year, representing 5.9% of Australia's Gross Domestic Product (GDP) for that period (ASCC, 2010). Workplace accidents in construction industry may also cause considerable financial losses for individual contractors. According to Levitt et al. (1981), accidents costs in construction companies in USA were found to be as high as 3% of the total construction project costs (10% of labour costs). The costs of accidents have long been regarded as a motivating factor for improving safety performance

⁵⁴ Y.feng@uws.edu.au

⁵⁵ P.wu@cqu.edu.au

⁵⁶ Xiaohua.jin@uws.edu.au

⁵⁷ jian.zuo@unisa.edu.au

(e.g., Heinrich 1931; Levitt 1975; Lingard and Rowlinson 2005). U.S. Department of labor (1955) argued that the main driving force behind the industrial safety movement is the fact that accidents are expensive, and substantial savings can be made by preventing them. Thus, preventing workplace accidents should make good economic sense for contractors (Dorman, 2000). Adopting Rognstad's (1993) view that that the main incentive of any construction firm is to generate profit; it can be assumed that a better understanding of the costs associated with workplace injuries would provide better incentive for management to invest in accident prevention. Therefore, there is a need for an investigation of the true costs of accidents to construction firms. Previous studies have examined the costs of accidents in various industries and countries/areas (e.g. Miller, 1997; Söderqvist, Rundmo and Aaltonen, 1990; Head and Harcourt, 1997). These studies have significantly contributed to people's understanding of workplace incident costs. The findings of these studies indicate that the costs of accidents are significant and should be paid much attention to. However, it appears that very few studies were conducted to examine the costs of workplace accidents to contractors in the building construction context in Australia. Against this background, this study aims to examine the true costs of accidents to building contractors in Australia.

LITERATURE REVIEW

The study on costs of accident was pioneered by Heinrich (1931) more than 80 years ago. Heinrich (1931) classified the costs as direct and indirect costs, and concluded that indirect costs are significant as he found that indirect costs accounted for as much as four times of the direct costs of accidents. In the *Wealth of Nations* Adam Smith (1776) wrote that a man educated at the expense of much labour and time may be compared to one of those expensive machines. This view helps to shed light on the vast costs of workplace accidents. The concept of Human Capital developed by Schultz (1961), Mincer (1958) and Becker (1964) refers to the stock of skills and knowledge embodied in the ability to perform labour so as to produce economic value. The Human Capital concept indicates that the losses of skilled labour services due to injury or illness is likely to incur additional losses to employers and impact upon the competitiveness of the employers (Lingard and Rowlinson, 2005). Human Capital concept has been applied to the analysis of injuries and illnesses costs, and the Human Capital method was popularized by Rice (1967). This method also posits two broad categories of costs: direct costs and indirect costs.

Direct accident costs are those actual cash flows that can be directly attributable to or associated with injuries and fatalities (Everett and Frank Jr. 1996; Hinze 1997). The direct costs of injuries tend to be those associated with the treatment of the injury and any unique compensation offered to workers as a consequence of being injured (Hinze, 1997). Different definitions exist for the indirect costs of accidents, but in general they are regarded as consisting of all the costs that are not covered by worker's compensation insurance (Hinze, 1991). The categorization of accident costs into direct and indirect costs implies that focus on the direct costs may fail to reveal the true losses to employers due to an accident. Many of the losses incurred by an accident are "hidden" and difficult to quantify. These "hidden" costs may be significant, and some may be particularly prominent in construction industry. For example, there are heavy penalties for time-overruns on construction projects (Lingard and Rowlinson, 2005). Therefore, both direct and indirect costs of accidents need to be examined to reflect the true costs of accidents to an employer. The indirect cost

theory of workplace accident developed by Brody et al. (1990) suggests that the identification of indirect costs will motivate cost-minimizing firms to increase investments in accident prevention to improve safety performance of building projects. The Accident Cost Iceberg proposed by Bird (1974) showed that the proportion of hidden costs could be much larger than the costs directly related to the accident.

In addition to traditional classification of accident cost as direct and indirect costs, several researchers proposed different accident cost typologies based on the specific characteristics of the accident costs. For example, in the cost typology proposed by Riel and Imbeau (1996), health and safety costs are classified into three categories: insurance-related costs; work-related costs; and perturbation-related costs. They are also classified as quantifiable, irreducible and intangible costs in this typology. Rikhardsson and Impgaard (2004) argued that the traditional cost components are rather difficult for management to use, as it would require a number of definitions and clarifications before use including asset specifications and income definitions. Thus, they categorized accident costs as time, materials and components, external services and other costs. These categories reflect traditional accounting classifications in accounting systems, thus they are believed to be simpler to apply by managers. Despite the debates on various typologies of accident costs, the consequences or cost components of accidents seem to be consistent among literature. The various components of indirect costs originate from studies that have been focused on accident costs in various industries (e.g., furniture, forestry, chemistry, cleaning service, financial service, and manufacturing). Nonetheless, the components of indirect accident costs from various industries demonstrate strong similarities. Based on the review of 16 past studies on accident costs, a set of components of indirect accident costs in construction environment was identified. The indirect costs of accidents comprise the following 13 possible components: (1) lost productivity due to the injured worker (e.g., Heinrich, 1931; Simonds and Grimaldi, 1956; Hinze, 1991); (2) lost productivity due to crew of injured worker (e.g., Heinrich, 1931; Hinze, 1991; Monnery, 1999); (3) lost productivity due to other workers in vicinity of accidents (e.g., Heinrich, 1931; Laufer, 1987; Hinze, 1991); (4) losses due to replacement of the injured worker (e.g., Laufer, 1987; Everett and Frank Jr., 1996; Monnery, 1999); (5) lost productivity due to the investigation or inspections as a result of the injury (Simonds and Grimaldi, 1956; Head and Harcourt, 1997); (6) cost of supervisory or staff effort (e.g., Heinrich, 1931; Simonds and Grimaldi, 1956; Hinze, 1991); (7) losses due to damaged equipment or plant, property, material or finished work due to the accident (e.g., Heinrich, 1931; Brody et al., 1990; Hinze, 1991); (8) cost of transporting injured worker (e.g., Simonds and Grimaldi, 1956; Hinze, 1991; Monnery, 1999); (9) consumption of first-aid materials in this accident (Hinze, 1991; Head and Harcourt, 1997); (10) additional work required as a result of the accident (e.g. cleaning, additional barriers and so on) (e.g., Simonds and Grimaldi, 1956; Laufer, 1987; Everett and Frank Jr., 1996); (11) fines and legal expenses (Leopold and Leonard, 1987; Head and Harcourt, 1997); (12) losses due to Stop Work Orders (SWO) issued to the project (disruption of schedules) (Brody et al., 1990; Everett and Frank Jr., 1996); and (13) additional benefits to the injured worker beyond the Work Compensation Act (WCA) (Heinrich, 1931).

METHODS

A case study research design was adopted for this study. A case study is suited to those studies which involve an in-depth analysis of a common set of features, in a given pool of data, over a defined period of time (Neuman, 2003). The current study provides just this – an analysis of the various incident costs (tangible and intangible) for all accidents recorded in a construction company during the calendar year of 2011.

For this study, data were collected from the incidents reported by Kell & Rigby during the 2011 calendar year. Kell and Rigby is a successful private construction firm established in Sydney in 1910. At the time of this study Kell & Rigby had an annual turnover of \$70M and employed 150 workers. These characteristics lend themselves toward the assumption that Kell & Rigby is representative of a typical NSW construction firms and thus a suitable case study for this research. The 27 incidents recorded in Kell & Rigby's 2011 incident register form the basis of the incident cost data collection.

To collect data for this study, three different data collection methods were used; review of archival records, completion of carefully prepared questionnaires, and structured interviews with Kell & Rigby managers. The case study is conducted of Kell & Rigby's register for incidents that occurred during the 2011 calendar year – a total of 27 incidents. In order to understand the costs incurred as a result of each accident, two data collection instruments were used; a questionnaire and a structured interview.

The questionnaire was designed with the objective of exploring the costs of the 27 accidents in Kell & Rigby's 2011 incident register. The components of accident cost on construction sites identified by Teo and Feng (2011) were adopted by this study to develop the questionnaire. A pilot study was conducted with 3 construction health and safety professionals in construction firms in Australia to test and improve the instruments. The first section of the questionnaire included general information regarding Kell & Rigby as a company and the credentials of the respondent (the GSEM). Section 1 was completed on all 27 questionnaires before they were issued to the GSEM for completion. Section 2 sought to identify general information regarding the severity and nature of any resulting injury, details of the injured person (i.e. their trade, age, experience etc.). This section was completed by the GSEM, given their knowledge of all 27 incidents which they had actively played a role in investigating. The third and final section, Section 3, had the purpose of identifying the tangible incident costs from categories 1 to 12 (See Section 2.5). As with Section 2, this section was completed by the GSEM who had accounting information and knowledge of each incident to record the costs. It was anticipated that not all of the details requested in the questionnaire would be immediately available to the GSEM however, given the GSEM's experience, in such cases it can be justified that assumptions or approximations are acceptable.

The interview questions sought to identify the intangible costs discussed in previous studies by Brody et al (1990) and Rikhardsson and Impgaard (2004). Three structured interviews were conducted with three top managers from Kell & Rigby; the GSEM, a Director and a Senior Project Manager. The interviews were structured around carefully prepared open-ended questions that sought to identify the intangible incident costs to the company. During the interview, the interviewees were read each question and asked to estimate the potential intangible costs to the company for the year of

2011, given the incidents recorded in the 2011 incident register. Probing questions were used in order to maximise the accuracy of the interviewee's responses. Following the interviews, each interviewee had their responses read back to them and asked to confirm the accuracy of the recorded response. In some cases the responses were altered at the request of the interviewee. Each of the interviewees was promised a copy of the finished thesis upon completion as gratitude for their contribution to the study.

RESULTS AND DISCUSSIONS

Transport Costs

Transport costs were incurred in 18 of the 27 recorded incidents throughout the 2011 calendar year. The costs were quite consistent in value, being between \$50 and \$500 (a range of \$450). The majority of transport costs fell around the \$300 mark. This result may be because \$300 is the standard rate for an ambulance service within metropolitan areas. It is likely that the lesser costs recorded were for transportation of injured workers in work vehicles. Likewise, it could be assumed that the higher transport costs (above \$300) were for transport of injured workers from sites outside of the metropolitan areas.

Management's Time on the day of Incident

Costs incurred due to management's time lost in addressing the incident, on the day of the incident, occurred in 23 of the 27 cases. The costs incurred were not very consistent across all incidents – between \$150 and \$5,000 (a range of \$4,850). The majority of occurrences where management's time was lost on the day of the incident were between \$200 and \$500. In one case (Case No. 116) the cost of management's time was \$5,000, the reason being that this incident involved the physical assault of a site manager.

Management's Time on the days Following Incident

Costs incurred due to management's time lost in the days following the incident, occurred in 24 of the 27 cases. By far the most frequent cost encountered (mode) within this category was \$500. There were a number of incidents that incurred in excess of \$1,000 – interestingly all of which were for incidents that didn't involve an injury. A reason for this result may have been that the incidents (mainly near-misses) identified new areas of risk which were preventable and thus management spent time in risk mitigation activities.

Lost Productivity of Injured Worker

This incident cost category includes incident cases where an injured worker continues to work immediately following an incident, at a reduced rate of productivity as a result. This category was applicable to 14 of the 27 cases and resulted in an average of \$315 incurred by the contractor in each incident. The majority of incidents applicable to this category incurred less than \$300 in lost productivity of the injured worker. This equates to roughly 5hrs of lost productivity ($\$60/\text{hr} \times 5\text{hrs} = \300).

Lost Productivity of Fellow Workers

Lost productivity of fellow workers only occurred in 3 incidents and the cost impact was witnessed to be relatively insignificant when compared with other categories. The cost of this item was between \$200 and \$300 – a range of only \$100. It could be

assumed that this incident cost category was incurred in incidents where fellow workers to an injured worker, drop their regular duties to assist with helping the injured worker. In a case where a fellow worker has suffered shock after witnessing a severe incident, it could be expected that the cost in this category would be more significant as the fellow worker may require counselling sessions.

Lost Productivity of Returned Worker

This incident cost category occurred in 9 of the incident cases investigated. The category includes costs that are incurred by the contractor as lost productivity when an injured worker returns to work on light (restricted) duties. This category, as with other lost productivity categories, is calculated by multiplying the lost productive hours by the workers hourly rate. Costs witnessed within this category were between \$180 and \$600. It is likely that this range represents a loss of between 3 hours ($\$60/\text{hr} \times 3\text{hrs} = \180) and 1 full day ($\$60/\text{hr} \times 10\text{hrs} = \600). This result supports other findings in the research where no incidents resulted in serious injury. If more a serious injury had occurred where a worker suffered long-term or permanent impairment, then costs arising from lost productivity of the returned worker would be likely to be much more significant.

Lost Productivity of Replacement Worker

Costs in this category were only witnessed in 4 incident cases where a replacement worker was sourced to mitigate lost productivity of the construction project whilst an injured worker is recovering or receiving treatment for their injury. Similar to cost category 6 above, it is expected that costs in this category would be infrequent given that no serious incidents occurred where an injured worker was out of work for an extended period. The costs witnessed (\$500, \$500, \$1,000 and \$1,000) reflect that replacement workers were utilised for 1 or 2 days in each of the 4 cases (i.e. $\$50/\text{hr} \times 10\text{hrs} = \500 , and $\$50/\text{hr} \times 20\text{hrs} = \$1,000$).

Site Shutdown Costs

Site shutdowns only occurred in 6 of the 27 incident cases however, their cost impact was the most significant. The average cost of site shutdowns in this study was \$6,333 and the incident cost ranged between \$2,000 and \$20,000. It was advised during the research that these costs included lost productivity, liquidated damages, unutilised plant and machinery, and cancellation of deliveries and labour hire.

First Aid and Medical Expenses

First aid and medical expenses were evident in 16 incident cases. The average cost was \$207.50 per incident and the range \$50 to \$550. This cost category applies to First Aid accessories and medical costs (i.e. medical centre visit) that the contractor incurred as a result of an incident where a worker was injured. This category most frequently occurred in incident cases where an injury was suffered. The majority of first aid and medical costs witnessed were between \$50 and \$300 which in comparison to other cost categories is relatively minimal however, a first aid or medical cost was apparent in every incident involving injury and therefore are important to observe.

Damage to Equipment and Machinery

Damage to equipment and machinery costs occurred in 7 instances and were second only to site shutdown costs as incident costs with the greatest financial impact. The

average cost per incident was \$2,243. In two incidents involving damage to equipment and machinery – the total cost impact was \$5,000.

Lost company opportunities

The respondents gave varying interpretation of the effect they believe 2011's incidents would have on their opportunities for future work. All three respondents made reference to the government work that they currently held and the fact that their safety record is a very important factor in their selection for government projects.

Kell&Rigby undertook a large amount of government work in 2011 (30% of their project portfolio). It was advised by the interview respondents that in order to secure government projects, Kell&Rigby must have an almost flawless incident track record. It was deemed by the respondents that the 2011 incidents would contribute to a loss of some future government tenders and as a result, a lost opportunity to the business.

The average cost for structured interview 1 was \$1,500,000. This cost must then be rationalised to address the fact that only 5% (GSEM advised this Kell&Rigby's current profit margin) of 1.5m is recognised as profit. Therefore, the total annual lost opportunity is \$75,000 (i.e. $\$1,500,000 * 0.05$). The cost is then averaged across each incident recorded for 2011 (27 incidents) and a figure of \$2,778 per incident is realised (i.e. $\$75,000/27 = \$2,778$ per incident).

Damage to Work Cover Insurance Premium

In Australia, workers compensation insurance providers calculate their client's premium based on their safety record for the previous year/s. Premiums are charged at a percentage of the client's annual payroll. A poor safety record for one year will often result in the premium percentage being increased for the following year. All the respondents acknowledged the company's low premium for the previous year of 2.5%. All the three respondents were adamant that this premium would increase for the following year. The average estimate of the potential increase in the premium by the three respondents is \$57,800. This figure represents the estimated increase to Kell&Rigby's insurance premium for 2012. When this cost is then averaged across each incident recorded for 2011 a figure of \$2,141 per incident is realised (i.e. $\$57,800/27 = \$2,141$).

CONCLUSIONS

In summary, the total tangible incident costs were \$386,310 and 0.55% of Kell&Rigby's annual turnover, or 11% of profit margin across all 2011 projects. The total intangible incident costs were \$132,800 and 0.19% of the company's annual turnover, or 3.8% of profit margin across all 2011 projects. Then, the total incident costs for 2011 (both tangible and intangible) were \$519,110 and equivalent to 0.74% of Kell&Rigby's 2011 annual turnover, or 14.8% of the profit margin across all 2011 projects. The result may provide better understanding of the financial implications of construction accidents to the contractors and may motivate the contractors to voluntarily invest in workplace safety to minimise the losses incurred by the construction accidents. The limitation of this study needs to be highlighted. The findings were reached based on the data collected from a single construction company in Australia. Thus, the generalizations of the findings to other populations may be difficult.

REFERENCES

- Australian Safety and Compensation Council (2009). The costs of work-related injury and illness for Australian employers, workers and the community: 2005-2006. Commonwealth of Australia, Barton, ACT, Australia.
- Becker, G. S. (1964). *Human Capital* (1st ed.). New York: Columbia University Press.
- Bird, F.E. (1974). *Management Guide to Loss Control*. Atlanta: Institute Press.
- Brody, B., Letourneau, Y. and Poirier, A. (1990). An indirect cost theory of work accident prevention. *Journal of Occupational Accidents*, 13, 255-270.
- Everett, J.G. & Frank Jr., P.B. (1996). Costs of accidents and injuries to the construction industry. *Journal of Construction Engineering and Management*. 122(2), 158-164.
- Head, L. and Harcourt, M. (1997). The direct and indirect costs of workplace accidents. Proceedings of the 11th AIRAANZ Conference, 30 January – 1 February 1997, Brisbane, Australia.
- Heinrich, H.W. (1931). *Industrial accident prevention*. New York: McGraw-Hill.
- Hinze, J. (1991). *Indirect Costs of Construction Accidents. A report to the Construction Industry Institute, The University of Texas at Austin*.
- Hinze, J. (1997). *Construction Safety*. New Jersey: Prentice-Hall.
- Laufer, A. (1987). Construction accident cost and management safety motivation. *Journal of Occupational Accidents*, 8, 295-315.
- Leopold, E. and Leonard, S., (1987). Costs of construction accidents to employers. *Journal of Occupational Accidents*, 8, 273-294.
- Levitt, R.E., Parker, H.W. and Samuelson, N.M. (1981). *Improving Construction Safety Performance: The user's role*. Technical Report No. 260, Stanford University.
- Levitt, R.E. (1975). *The effect of top management on safety in construction*. Technical Report No. 196. The Construction Institute, Stanford University.
- Lingard, H. and Rowlinson, S. (2005). *Occupational Health and Safety in Construction Project Management*. New York: Spon Press.
- Miller, T.R. (1997). Estimating the costs of injury to U.S. employers. *Journal of Safety Research*, 28(1), 1-13.
- Mincer, J. (1958). Investment in Human Capital and Personal Income Distribution. *Journal of Political Economy*, 66, 281.
- Monnery, N. (1999). The costs of accidents and work-related ill-health to a cheque clearing department of a financial services organization. *Safety Science*, 31, 59-69.
- Neuman, W.L. (2003). *Social Research Methods: Qualitative and Quantitative Approaches*. Boston: Allyn and Bacon.
- Rice, D.P. (1967). Estimating the cost of illness. *American Journal of Public Health* 57(3), 424-440.
- Riel, P.F. and Imbeau, D. (1996). Justifying investments in industrial ergonomics. *International Journal of Industrial Ergonomics*, 18, 349-361.
- Rikhardsson, P.M. and Impgaard, M. (2004). Corporate cost of occupational accidents: an activity-based analysis. *Accident Analysis and Prevention*, 36, 173-182.
- Rognstad, K. (1993). Costs of occupational accidents and diseases in Norway. *European Journal of Operational Research*, 75, 553-556.

- Schultz, T.W. (1961). Investment in Human Capital. *American Economic Review*, March 1961, 1- 17.
- Simonds, R.H. and Grimaldi, J.V. (1956). *Safety Management: Accident Cost and Control*. Richard D. Irwin, Homewood, Ill.
- Smith, A. (1776). *The Wealth of Nations*. Random House, Inc.
- Söderqvist, A., Rundmo, T. and Aaltonen, M. (1990). Costs of occupational accidents in the Nordic furniture industry (Sweden, Norway, Finland). *Journal of Occupational Accidents*, 12, 79-88.
- Teo, A.L. and Feng, Y. (2011). Costs of construction accidents to Singapore contractors. *The International Journal of Construction Management*, 11(3), pp. 79-92.
- U.S. Department of Labor, Bureau of Labor Standards, (1955). *Safety subjects*. Bulletin No. 67. U.S. Government Printing Office, Washington, D.C.

NEAR-MISS REPORTING AMONG CONSTRUCTION WORKERS

Radhlinah Aulin¹ and Emma Linderbäck²

⁵⁸*Construction Management, Lund University, Sweden*

⁵⁹*Skanska, Skanska Sverige AB, Sweden*

In 2012, there were 11 000 accidents and near-miss reported of which most of it can be prevented. Though reporting and investigating injuries present a more detailed picture, this is still a lagging indicator — measuring after the event. Recording and investigating near misses, on the other hand, can be used as a positive indicator of performance tool to fix problems before injuries occur. Employers are obligated to inform about near-miss to the workers so that they are aware what a near-miss is, how to report a near-miss and whom to report to. By definition, near-miss leaves no injuries, nor property or equipment damage. They also leave little (or no) evidence that they even occurred and as such, easy to ignore. As a result, workers have no reason to believe reports will be viewed positively and acted on. This study aims to investigate how well informed construction workers are about near-miss reporting. Importantly, investigations will be performed to identify factors that influence workers' willingness to report near misses that they were exposed to or had observed. To achieve the aims, a deductive approach was adopted. Interviews were conducted with 37 construction workers from two districts, all within the same contractor's organisation. Although results indicated that majority of the interviewees are familiar with the definition of a near-miss and routines of reporting, the willingness to report near misses is still low. The study had also identified obstacles to reporting and proposed suggestions to address this issue. Results from this exploratory empirical investigation will be used as a basis for a more substantial empirical investigation.

Keywords: near miss, reporting system, resistance to reporting, construction, injuries

INTRODUCTION

The construction industry is constantly working to improve its incidents statistics. The use of accident data has been identified as an important practice in the preventions of accidents (Wu, Gibb & Li Q 2010). Recognising signals before an accident occurs offers the potential to design effective prevention strategies. Apart from the 'ex post' (accidents data) analysis, 'ex ante' (alerts, signals and prior indicators) focus on near-miss events that has the potential to be used as a tool, focusing on eliminating workplace incidents. Incidents (accidents, ill-health and near misses) are caused by unsafe acts or unsafe conditions that disrupt or have the potential to disrupt the workflow, regardless of whether the event causes injury or property damage (Phimister et al. 2004). Therefore, a near-miss should be regarded as an important warning that an accident may occur. The Swedish Work Environment Authority

⁵⁸ radhlinah.aulin@construction.lth.se

⁵⁹ emma.linderback@gmail.com

(SWEA) requires all employers to inform workers about near-miss and workers are aware what should be reported, how to report and whom to report to. All reported incidents and near-misses must be investigated, assessed, act upon and follow-up.

Based on the requirement by SWEA, it is interesting to know how well versed the workers are about near-miss. The research questions therefore are: why do many organisations struggle to make near-miss reporting a successful part of their safety culture? What factors discourage construction workers from reporting a near-miss? How can an organization encourage near-miss reporting? An exploratory empirical investigation was performed to seek these answers. Importantly, investigations will also be performed to identify factors that influence workers' willingness to report near misses that they were exposed to or had observed. Additionally, discussions will present how an organisation can improve their near-miss reporting system. The study adopted a deductive approach, which implies that it begins with a review of literature and previous research on the problem area. This will form the basis for the design of the empirical data collection. The study is conducted using a qualitative method where data is collected through interviews. 37 construction workers from two zones (the east and the south of Sweden) all within the same organisation participated in the study. The organisation under study employs traditional reporting mechanism including filling a form or reporting directly to the site supervisors. State-of-the art digital systems such as Ipad were not in use for reporting at the time the investigations were performed.

SWEDISH CONSTRUCTION INCIDENTS OVERVIEW

In Sweden, the increase of fatalities in construction since 2000 is worrying. A black month for the industry was in May 2011 when seven major accidents, including three deaths from falls, were reported (Nohrstedt, 2011). In 2012, the rate of accidents in the construction industry had receded to 11.4 accidents per 1000 workers from 11.7 accidents (Samuelsson, 2012). This is a reduction of 3% from the previous year. For occupational health, the positive downward trend continues with frequency decreased from 2.6 to 2.3 (events per 1000 workers). This is the lowest rate ever recorded. The presence of legal and regulatory requirements ensures that accident reporting is essential as produced in the annual occupational accident reports produced by the SWEA. In all accident cases, both identification and reporting are all but guaranteed (Phimister et al. 2003). These reports only discussed the forensic evaluation of accidents and ill-health data and not near-misses. In contrast, for near-miss incidents, many may occur unnoticed. Even for recognised near misses, the priority is low.

NEAR-MISS REPORTING

Near-miss definition

To begin with, there are is no disagreement among safety professionals on the need to report, record and assess near misses to improve safety. The only confusion is in deciding what counts as a near-miss. For an organisation to increase their near-miss reporting, it is vital to have a clear definition of the term. So what is a near-miss? The term itself is widely debated. Familiar alternative terms for these events are a “close call,” a “narrow escape” or in the case of moving objects, “near collision” or a “near hit.” Phimister et al. (2004) defined near-miss as an unplanned event that did not result in injury, illness, or damage – but had the potential to do so. Only a fortunate break in the chain of events prevented injury, fatality or damage; in other words, a miss that

was nonetheless significant and may have caused damage. SWEA defined near-miss as an undesired event or situation that could lead to health problems, illness or accident (ADI 306).

According to Cambraia, Saurin & Formosa (2010) the definition is far from precise, especially when seeking to differentiate near misses from other situations such as unsafe acts and unsafe conditions. The authors formulated near-miss definition in their study as "an instantaneous event, which involved the sudden release of energy and had the potential to generate an accident". Its consequence does not result in personal injuries or material damage, but only in the loss of time. They propose that near-miss be categorised as both reactive and proactive. Reactive information refers to near-miss event not leading to injuries or material damage, but rather a release of energy. On the other hand, the proactive nature of near-miss is linked to the information generated allowing actions to be performed to prevent injury in the future.

Jones et al. (1999) classified near-miss into two types: (a) extended near misses where the event could give rise to an accident, having an impact not only on individual but also communities and the environment; (b) where near misses are high risks situations that could result in individual accidents. Another scholar Reason (1997) had classified near-miss according to the type of feedback, whether positive or negative to safety management. In positive feedback, preventive measures function as per what was planned or the worker manages to regain control. In contrast, accidents in negative feedback do not occur by chance, since preventive measures do not work or do not exist. Employing the recording of near misses helps to strengthen safety culture (Glendon & Stanton 2000) hence motivating workers to identify, report, record and analyse the events (Reason 1997, Jones et al. 1999).

Near-miss reporting culture

Studies carried out by Heinrich et al. (1980), Bird and Germain (1966), Masimore, (2007) and Manuele, 2011 for example, had highlighted the importance of managing efficiently near-miss events in order to reduce incidents. Prevention needs to be aimed not only at events higher in the pyramid, which have serious consequences but also those at the lower levels including near misses (Konstandinidou et al. 2011). High risk industries such as civil aviation, nuclear power and chemical industry, use data from near misses as important indicators in the prevention of accidents (Cambraia, Saurin & Formosa 2010).

Figure 1 illustrates that near misses occur more frequently than accidents, thus, recording and investigating near misses, can be used as a positive indicator or as a performance tool to fix problems before injuries occur. Undeniably, Wu, Gibb & Li (2010) claimed that analysis of near misses has the potential to be a great supplement to the safety data set, especially where the concentration is on the high potential incidents. To create a reporting culture within an organisation, it requires active participation of workers and avoids assigning blame. As near-miss incidents often result in no injuries, no property or equipment damage, they tend to be overlooked or ignored as warning signs that an accident may occur. As such, Williamsen (2013) concluded that workers have no reason to believe that near-miss reporting will be viewed positively or acted upon. As a result, poor reporting culture lead to loss of opportunities to prevent incidents. Recognizing and reporting near-miss incidents can significantly improve workers safety and enhance an organisation's safety culture (Williamsen 2013).

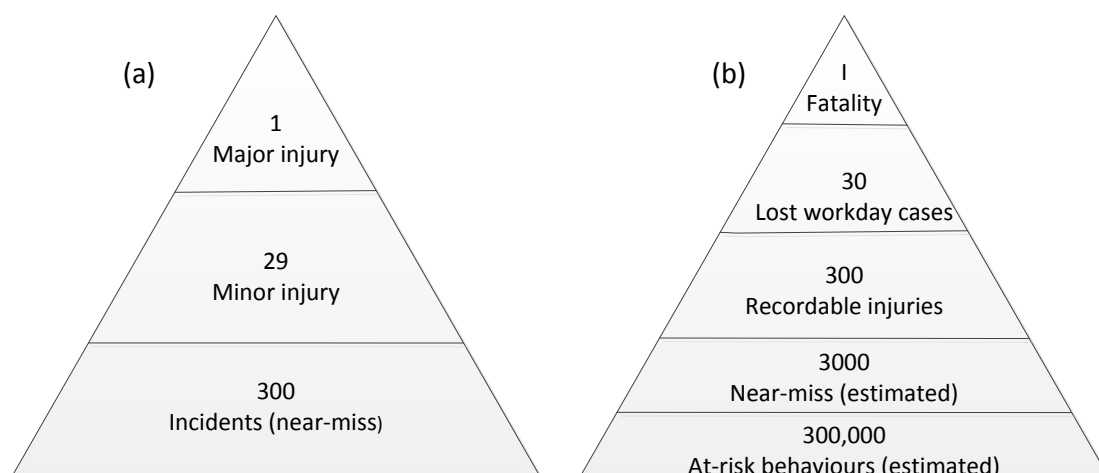

Figure 1 - At-risk behaviours proposed by Heinrich (a) and Massimore (b) (Gnoni et al. 2012)

Barriers to near-miss reporting

Figure 1 demonstrates a commonly accepted assumption that the number of near-miss event is higher than major accidents. Therefore, near-miss analysis requires a higher resource effort usually due to the huge volume of data to be analysed (Gnoni & Lettera 2012). Phimister et al. (2003) had identified seven critical stages for effectiveness for near-miss reporting: (1) identification of near miss, (2) reporting and prioritisation, (3) distribution of relevant information, (4) casual analysis, (5) identification of solutions to prevent recurrence, (6) dissemination of remedial actions and (7) resolution through tracking. It is important to understand the fundamental issues involved at each stage. For example, it is important to avoid cumbersome reporting forms, lengthy analysis for every near-miss, corrective actions that discourage future reporting and so forth. Any of these flaws could cause more harm than good to the overall safety process. Where a near-miss that is not reported, it cannot be concluded that the risk exposure is reduced. Nonetheless, where a near-miss that is identified but not reported, or identified and reported but not acted upon, will, have a modest impact on reducing site risk exposure (Phimister et al. 2003).

Building a reporting culture that includes identifying and reporting near misses faces many challenges. Among the contributing factors identified by Cambraia, Saurin & Formosa (2010) on workers' reluctance to report near-miss are: (a) fear of disciplinary action, as a result of blame-culture for the lack of safety; (b) the acceptance of risk that comes with the job and cannot be prevented; (c) the macho culture; (d) the lack of feedback from reported incidences and (e) the perception that data collection is difficult and time consuming. Halldin (2006) claimed that many workers viewed near-miss reporting as meaningless saying that reporting the event does not contribute any improvement or risk reduction in the work. Management seems to give limited feedback of near-miss analysis to workers (van der Schaaf & Kanse 2004; Halldin 2006). Workers are unclear about their organisation's definition of near-miss (Dunn 2003). Thus, a common agreement on how an organisation defines the term is crucial. In order to create a positive reporting culture, reporting must be easy and fast and reasons for reluctance removed or reduced. The reporting procedures must be made

known to all in the organisation (van der Schaaf & Kanse 2004). For projects that face time constraints, there is a huge possibility that reporting near-miss may be a burden or viewed as extra work (Dunn 2003).

There is also the issue of the macho-culture where risk acceptance is high among construction workers. Paradoxically, experience tends to reduce carefulness, while it increases confidence in one's ability to deal with eventuality increasing their risk acceptance. These workers view near-miss reporting as weak. Group pressure could also be a factor that discourages near-miss reporting (van der Schaaf & Kanse 2004). Simultaneously, there are fears among workers for disciplinary actions by the management (Dunn, 2003) and this will make the workers have a guilty conscience for any wrong-doing that cause a near-miss. According to Dekker (2012) reporting a near-miss may mirror that the worker had done something wrong and this might lead to loss of confidence by the management. Conversely, workers too may not have faith in the management when nothing is being done with near-miss reports. From the above discussions, the factors that may influence workers' willingness to report near-miss can be summarised in Table 1:

Table 1: Factors influencing workers' willingness to reporting near-miss

Factors	
Meaningless	Lack of feedback from reported incidences
Ignorance	Unclear on the definition of near-miss and why should it be reported
Practical reasons	Complicated and time consuming
High tolerance for risk /risk acceptance	Risk acceptance is high among construction workers
Fear	Faces disciplinary actions by management or mobbed by peer-group.
Lack of confidence for management	Lack of faith in the management when nothing is being done with near-miss reports
Guilty conscience	Near-miss incidents are linked with self- failure

NO-BLAME CULTURE

Organisations can effectively learn from experience and achieve improvements in performance outcome such as increase productivity and survival rate (Reason 1997). Organisation learning involves detection and correction of error. When the error and detection permits the organisation to carry out its present objectives, then that error, - detection -and correction processes is single-loop learning. Double-loop learning occurs when error is detected and corrected in ways that involve the modification of an organisation's underlying norm, policies and objectives (Provera, Montefusco & Canato 2005). One way to encourage single or double loop learning is to adopt the no-blame approach. Provera, Montefusco & Canato (2005) have studied how the term "no-blame" can be used as an organisational approach characterised by a positive vision of errors. This means that, by relying on a particular set of organisational tools, errors and near misses observed by or involving individuals while completing their tasks are used as a basis for organisational learning. Reporting near misses is a voluntary action by workers. Therefore, cultivating a no-blame culture is essential to

capture vital learning. A no-blame approach underpins a shift in the attention focus from the identification of blame as mismanagement of tasks at individual or group level, to its conceptualisation as an operational lesson which might enhance future performances. Based on the assumption that no system is entirely flawless, a no-blame system represents a structured approach to managing organisational errors. The aim of this approach is to inculcate a culture where human errors will not result in punishment rather as an organisational learning tool.

RESULTS AND DISCUSSIONS

Respondents & company's background

Face-to-face interviews were carried out in two districts - south Skåne (District A) and east Götland (District B) under the company 'X'. Company X is among the leading construction companies in terms of health and safety. One of the company's top visions is achieving an accident free work environment. The company management claimed that it has a well-defined reporting system which is applicable for both accidents and near-miss. Here, all accidents and near misses can be reported either verbally or written to the supervisors or project manager. Once the report is recorded, the safety manager then will classify the incident and perform the investigation. For near-misses, analysis will be performed based on the Swiss-cheese model by Reason (1997). The near-miss analysis model identified which safety system was breached or missing, using data accidents including events that did not result in an actual accident. In 2013, the company received an average of 20 near-miss reports every month which is a rise in comparison to 2011 when it was first introduced. Results from the analysis are notified to all district offices with the organisation.

In this study, a total of 37 workers were interviewed and 19 workers are from the District A and 18 workers from District B. The mean ages of the respondents are 44 years old while the mean years of work experience is 23 years. Only eight respondents have less than 10 years of work experience. Interestingly, only 16 respondents had some experience reporting near-miss incidents. To get good insight on the research questions, semi-structured interviews were performed that combined a pre-determined set of open questions (questions that prompt discussion) with the opportunity for the interviewer to explore particular themes or responses further. Semi-structured interviews are used to understand how interventions work and how they could be improved. It also allows respondents to discuss and raise issues that the study may not have considered (Patel and Davidson 2011).

Analysis and discussions

The following discussions are results from the interviews:

Q1: What is your understanding of the term near-miss?

When asked on their understanding of the definition of near-miss, majority of respondents said that "a happening that did not result in an accident because something stopped it". This means that a happening can be something unexpected or undesirable where no one is injured but the risk for an accident to happen is still there. The rest of the respondents had ambiguous descriptions of the definition but, after further probing had the same essence. For example one respondent said that near-miss is more like "oops!" whereas accident is "oh no!".

Q2: When were you informed about what a near-miss is and the routine to report it?

There are variations of responses to this question. However, all of the respondents were informed about near-miss reporting and aware of the routine involved. 7 respondents that have less than 10 years of work experience received this information during the introduction. The rest of the respondents were informed during recent years where the focus and attention on health and safety had increased. Since health and safety is among the top agenda during the organisation weekly meetings, information about near-miss incidents is conveyed during such occasions. There was a disagreement about what should be reported. A total of 13 respondents agreed that all type of near-miss whether major or trivial should be reported citing that this is important to help with prevention of accidents. On the other hand, six respondents claimed that only major near misses that could lead to injury should be reported and analysed. The rest of the respondents believe that was pure common sense on what to report or not.

Q3: Do you see the benefit of near-miss reporting?

All respondents agreed that reporting near misses would lead to 'learning from mistakes'. This organisational learning helps the company to design better preventive measures to reduce risks and stop undesired situations from repeating. Most respondents would like to see the published statistics on near misses and their analysis.

Q4: What are the barriers that hinder near-miss reporting?

For this section, the respondents were presented with a list of barriers (as in Table 1) that hinder the willingness to report near-miss. The results are presented in Table 2.

Table 2: Reasons for not reporting near misses at the workplace

	District A (no of respondents)	District B (no of respondents)
High tolerance for risk/ risk acceptance	13	13
Guilty conscience	9	13
Ignorance	7	9
Meaningless	7	6
Practical reasons	4	9
Fear	6	5
Lack of confidence	4	2

High tolerance for risk / risk acceptance and guilty conscience seems to dominate the response and alarmingly respondents with more than 20 years of working experience are in this category. For this cohort, experience tends to reduce carefulness, while it increases confidence in one's ability to deal with an eventuality. Here, workers were behaving on the basis of their estimate of personal risk and not of general risk and that they rate the risk lower for themselves than their peers, a tendency referred to as "comparative optimism" (Sjöberg, 2000). Additionally, majority of the respondents are aware and accept of the risks associated with their work.

Surprisingly, despite the respondents understanding of the definition of a near-miss, many respondents felt that they actually are unsure exactly what to report especially true in the case of District B group. Hence, it is not just about the knowledge on near-miss occurrences but rather the understanding and comprehension of its importance. One respondent suggested that near-miss reports should be discussed with all employees regardless of their severity to allow learning from the incidents. Less than half of the respondents felt that near-miss reporting is meaningless and do not contribute to any learning or improvement. They regards it is as insignificant to contribute to the reporting.

Despite the simple process of reporting (filling in a form or reporting directly to the site supervisors), 50% of respondents from District B felt that the routine is complicated and time consuming. This may be true in a stressful work environment where deadlines and piece rate work are significant. The response on fear to report is low in comparison to other barriers and shows compelling signs that this factor is less significant. The majority of respondents (70%) agree that using fear to avoid reporting is unacceptable in any work environment. The lowest score is for lack of confidence in reporting where 21% respondents claimed that they do have confidence with their project leaders thereby instilling unwillingness to report near-miss incidents.

Suggested measures to improve near-miss reporting

In general, all respondents agreed that the company is positively driven towards improving its health and safety performance. They welcome all measures to improve the work environment. In that respect, management need to be more active to constantly encourage workers to report any incidences. Benefits gained from near-miss analysis must be disseminated to all workers on site, within the wider organisation and externally. This mean that for every near miss analysis performed, all feedback, lessons learned, preventive measures identified and designed must be conveyed to all employees within and outside the project. Currently, only major near-miss events are being investigated, analysed and reported to all within the organisation. Nevertheless, near-miss analysis feedback from other projects is welcomed by workers perceiving it as a lessons learned. Here, respondents are in agreement that near-miss reporting is one way to identify risks and avoid failures and carelessness in the site work activity. Finally, without doubt, the role of management is important to implement an effective near-miss reporting routine. Apart from the routine, management must highlight that a 'no-blame' culture is the way forward. Management must encourage workers not to be pressured by group norms. Several respondents pointed out that there is a fear of being criticised when reporting near misses especially trivial incidents. They suggested that management need to work on this issue and inspiring a no-blame culture is the way forward.

CONCLUSIONS

Theoretically, near misses occur more frequently than accidents and should be regarded and treated as an important precursor to an accident. Near misses should be reported, investigated and communicated to the person involved and other workers exposed from the same risks. A study performed by Konstandinidou et al. (2011) on installation personnel demonstrated that by improving the reporting system and providing better training to the operators had helped to decrease the number of near misses which in turn has a synergy effect in decreasing the total number of accidents on the upper levels of the Bird's triangle.

The company under study has a system that encourages workers involved in or observing near misses to report. Majority of the interviewees are in agreement with the general understanding of concept of a near-miss and the routine of reporting it. For the company, the challenge is to create a culture where no level of incidents is accepted, hence encouraging construction workers to file near-miss reports. The main obstacle for reporting is that construction workers have a high tolerance for risk and accept risk in their work to the extent that it makes them blind to the near misses occurrences around them. They also feel guilty for doing something wrong. These two reasons have the highest impact on whether they choose to report the near-miss incidents. Other important reasons are uncertainty of what to report and that it is complicated to make the report (from District B). This suggest the organisation system for reporting is somewhat flawed. It is recommended that organisation introduce and implement a no-blame culture to encourage the workers to report. There is scope for improvement in achieving a common understanding about what a near-miss is, what to report and make the reporting procedure easier. Results from this study will be used to perform further investigation with wider samples and to include management perspectives.

REFERENCES

- Bird, F E, and Germain, G L (1966) "Damage Control". New York: American Management Association.
- Cambraia, F B, Saurin, T A, and Formoso, C T (2010) Identification, analysis and dissemination of information on near misses: A case study in the construction industry. "Safety Science", 48 (1), 91-99.
- Dekker, S (2012) "Just Culture: Balancing Safety and Accountability". 2ed. Ashgate Publishing Limited, Hampshire England.
- Dunn, D (2003) Incident reports - their purpose and scope. "AORN Journal", 78(1), 49-61.
- Gherardi, S and Nicolini, D (2002) Learning the trade: A culture of safety in practice. "Organization", 9(2), 191-223.
- Glendon, A L and Stanton, N A (2000) Perspective of safety culture. "Safety Science", 34(1-39), 193-214.
- Gnoni, M G and Lettera, G, (2012) Near-miss management systems: a methodological comparison. "Journal of Loss Prev. Process Ind", 25(3), 1-8.
- Halldin, B (2009) "Checklista för bra arbetsmiljö - uppnå certifieringskraven I OHSAS 18001 och inspireras till systematisk utveckling". Stockholm: SIS Förlag.
- Heinrich, H W, Petersoen, D, Roos, N R and Hazlett, S (1980) "Industrial Accident Prevention: A safety Management Approach. 5ed. New York: Mc-Graw Hill.
- Jones, S, Kirchsteiger, C and Bjerke, W (1999) The importance of near-miss reporting to further improve safety performance . "Journal of Loss prevention in the Process Industries", 12(1), 59-67.
- Konstandinidou, M, Nivolianitou, Z, Kefalogianni E and Caroni, C (2011) In -depth analysis of the casual factors of incidents reported in the Greek petrochemical industry. "Realibility Engineering and System safety", 96, 1448-1455.
- Linderbäck, E (2013) "Tillbudsrapportering ur yrkesarbetarens perspektiv" Masters thesis, Division of Construction Management, Lund University.

- Manuele, F A, (2011) Reviewing Heinrich dislodging two myths from the practice of safety. "Professional Safety", 52-61.
- Masimore, L (2007) "Proving the Value of Safety Justification and ROI of Safety Programs and Machine Safety Investment", (white paper) Rockwell Automation.
- Nohrstedt, L (2011) 3 döda på en månad. "Byggvärlden". 2011-06-16.
- Patel, R & Davidson, B (2011) "Forskningsmetodikens grunder - att planera, genomföra och rapportera en undersökning". Lund: Studentlitteratur AB.
- Phimister, J R, Oktem, U, Kleindorfer, P R, and Kunreuther, H (2003) Near-miss incident management in chemical process industry. "Risk Analysis", 23 (3), 445-459.
- Provera, B, Montefusco, A and Canato, A (2005) A no blame approach to organisational learning . In Gherardi, S & Nicolini, D (Ed.), "6th International Conference on Organisation Learning and Knowledge", University of Trento.
- Reason, J (1997) "Managing the Risks of Organizational Accidents". Aldershot, England: Ashgate Publishing Limited.
- Samuelsson, B (2012) "Arbets-skador inom byggindustrin". Byggindustrin Centrala Arbetsmiljöråd.
- Sjöberg, L (2000) Factors in risk perception. "Risk Analysis", 20, 1-11.
- Van der Schaaf, T and Kanse, L (2004) Biases in incident reporting databases: an empirical study in the chemical process industry. "Safety Science", 42 (1), 57-67.
- Williamsen, M (2013) Near-miss reporting: A missing link in safety culture. "Professional Safety", Retrieved from www.asse.org. (20/01/14)
- Wu, W, Gibb, A G F and Li, Q (2010) Accidents precursors and near misses on construction sites: An investigation tool to derive information from accident databases. "Safety Science", 48, 845-858.

Role of stakeholders

ANALYSIS OF DIFFERENCE/SIMILARITY BETWEEN CONSTRUCTION PROJECT PARTICIPANTS' WORK HEALTH AND SAFETY (WHS) RISK PERCEPTIONS

Peihua Zhang⁶⁰, Helen Lingard¹, Nick Blismas¹, Ron Wakefield¹, Brian Kleiner⁶¹

¹ *Centre for Construction Work Health and Safety Research, RMIT University, Australia*

² *Centre for Innovation in Construction Safety & Health, Virginia Tech, US*

This research aims to analyse the within- and between-group similarity/difference in WHS risk perceptions of construction project participants. This study employs Q-methodology with an innovative photographic data collection method to explore construction project participants' WHS risk perceptions. Specifically, a set of photos were selected to represent a range of commonly used construction methodologies/building systems. Participants invited from four professional groups were requested to 'sort' the set of photos according to their judgements of the likelihood and magnitude of WHS risks associated with constructing these different systems. This paper reports a preliminary analysis of the within- and between-group similarity/difference in WHS risk perceptions related to constructing different façade systems and roof systems. Nonparametric statistic methods, i.e. Kendall's Coefficient of Concordance (W) and Spearman's Rank Order Correlation (r_s), were used to analyse the data. This study finds that professional groups' risk perceptions can be influenced by the different levels of complexity inherent in constructing different building elements. Professional groups share lower within-group and between-group similarities in the judgement of likelihood of risks than in the judgement of severity of risks. Professional groups' risk perceptions are also largely affected by a wide range of social factors such as personal experience, attitude, beliefs and contextual environment. Therefore, participants from the same professional group may show different risk perceptions, while participants from different professional groups may share similar risk perceptions. This research provides the basis for developing an image-based tool in the planning and design stage of a construction project to engage all project team members in discussion about the WHS implications of their decision making. The tool will help construction participant groups to understand each other's WHS perspective. This will facilitate the development of a shared mental model of WHS within construction projects and create a strong and positive safety culture. This research is, to our knowledge, the first attempt to employ Q-methodology in studying construction participants' OSH risk perceptions. It provides a new starting point for other researchers to study risk perception in the construction management area.

Key words: work health and safety, risk perception, construction, Q-methodology

INTRODUCTION

The primary responsibility for site safety has traditionally been ascribed to general/principal contractors (Toole, 2002). Regulations and policies assign substantial obligations to contractors to plan for health and safety, and assess the risks

⁶⁰ rita.zhang@rmit.edu.au; helen.lingad@rmit.edu.au; nick.blismas@rmit.edu.au;
ron.wakefield@rmit.edu.au

⁶¹ bkliener@vt.edu

to their employees (Hare et al., 2006). Therefore, early efforts to improve construction work health and safety (WHS) performance have mainly targeted contractors. Though some recent improvements have been noticed, construction WHS performance is still relatively poor and more improvements are desired (Atkinson, 2010).

There is increasing recognition among researchers that WHS risks in the construction stage can be traced back to decisions made by project participants in the planning and design stage. For example, Cooke et al. (2011) found that a client's decision to changing the technical requirements of a constructed facility lead to WHS impact on construction workers. Behm (2005) reviewed 224 fatality investigation reports and found that 42% of the fatalities are linked to design decisions. The result is further confirmed in another study conducted by Gambatese et al. (2008). It is the design that determines how project components will be assembled and what construction tasks will be undertaken (Gambatese & Hinze, 1999). Recently, the concept of Construction Hazard Prevention through Design (CHPtD) has received much attention from researchers (see, for example, Toole & Gambatese (2008), Gangoellis et al. (2010)). There is therefore substantial opportunity for reducing WHS risk upstream by ensuring decision-makers take WHS considerations into consideration earlier in the process. They need to evaluate the potential impact of their decisions on WHS in the construction stage, and formulate appropriate strategies to control or eliminate WHS risks at sources.

In real practice, however, the WHS risks perceived by decision makers are sometimes markedly different from the perceptions of personnel involved in the construction process or what actually happens on site. The construction industry is highly fragmented and complex. Decision makers are usually organizationally and spatially distal from productive work, and decisions are usually made before commencement of construction works. The construction industry is also characterized by adversarial relationships between project participants, who usually pursue different project interests. In such an environment, it is difficult for decision makers to 'take the perspective' of persons whose WHS might be affected by their decisions. Practically, the fact that designers usually lack construction process knowledge, lack formal education of construction safety as well as have limited involvement in overseeing site safety create further barriers for them to consider WHS risks properly (Gambatese & Hinze, 1999; Toole, 2002).

AIM

This study is part of a research project that attempts to understand the similarity/differences between different professional groups' risk perceptions. This understanding will inform each professional group of other groups' perspectives, and help in establishing a shared mental model in terms of risk perceptions. This paper reports preliminary findings of within- and between-group similarity/difference in project participant groups' risk perceptions.

RISK PERCEPTION

Risk perception is an individual's subjective judgement about the frequency and severity of hazards associated with an activity or an event (Baradan & Usmen, 2006; Hallowell, 2010). Risk perception is subjective in nature because it is influenced by a large number of sociotechnical factors, including individuals' personal beliefs, attitudes, occupation, perspectives, experience, etc. (see for example, Flin et al.

(1996); Holmes et al. (1998)). Risk perception is an antecedent to safety-related decisions and behaviours. Surry's (1979) decision model of accident occurrence illustrates that risk perceptions provide sensory cues to individuals, who then cognitively process the sensory cues, and decide the response to the cues by applying decision making rules. Previous research has reported the strong link between individual risk perception and one's behaviour toward the risk. For example, Arezes & Miguel (2008) find that industrial workers who have better recognition of noise related risks tend to use hearing protection devices (HPDs) more consistently. On the contrary, any biases in risk perception can cause misinterpretations of potential risk impact, which then lead to inappropriate risk behaviour.

At the risk management level, risk perception provides the basis for the conceptualization of risk control/mitigation strategy. If a decision-maker can't perceive a risk accurately then 'safe' decisions are unlikely to eventuate. In circumstances where multiple participant groups are involved, conflicts in risk perceptions would result in subsequent conflicts in risk control strategy. In an occupational health and safety (OHS) study conducted by Iavicoli et al. (2011), researchers report that there are gaps between stakeholders' (including employers, trade unions and government institutions) perceptions regarding psychological risks and work related stress in the European Union (EU), and the perception gaps cause consequent difficulty in implementing shared prevention/correction strategies. Similarly, the discrepancy between construction project participants' understanding of the nature of WHS risks and/or opportunities for control may significantly hinder the effectiveness of WHS risk management in a construction project. Therefore, it is imperative to study how different participant groups perceive risks and seek opportunities to inform each other's risk perspectives. This would help to promote 'perspective taking' in project decision-making, especially when the decisions have significant impact on WHS in the construction stage.

RESEARCH DESIGN

Q-methodology

An innovative photographic data collection method based on Q-methodology was used to explore construction professional groups' WHS risk perceptions. Q-methodology is recommended to be a suitable technique to study cognitive structure, attitude, and perceptions of people (Anandarajan et al., 2006). Q-methodology requires participants (named as P-set) to put a sample of objects (known as a Q-set) into a rank order according to a condition of instruction. When the objects are arrayed into categories, the resulting pattern is called a Q-sort (Brown, 1980). A Q-sort is a reflection of a person's subjective view about a phenomenon, suggesting this person's conception of the way things stand.

The Q-set can take different forms, such as statements of opinions, photos, or other stimuli. In this study, photographs representing the construction processes implicit in different building systems were used as stimuli. Photographs are effective and straightforward in depicting a construction scenario, yet maintain the richness of information needed to assess WHS risks. Photographs have been effectively used as stimuli for Q-sorting in landscaping studies (see, for example, (Green, 2005), (Fairweather et al., 1998)), and also successfully used as experimental stimuli in construction hazard identification (Kleiner and Hallowell, 2012). The detailed processes of developing the photographic tool have been introduced in Zhang, et al.

(2013). As the current paper mainly focuses on reporting the results from a preliminary study by utilizing the photographic tool, only a brief description to the tool development is provided here.

Q-set generation

Q-methodology requires researchers to generate a Q-set which is broadly representative of the issues under investigation (Stenner et al., 2008; Watts & Stenner, 2005). Photographs representing different but commonly used construction methodologies/building systems to four building elements (i.e. façade, roof, structure, and building service) were specifically selected. Those photographs were presented to industrial practitioners and subjected to a pilot validation to ensure that photos are indeed representative and provide sufficient information for participants to make judgements. Finally, eight photographs were retained for each building system. Figure 1 shows sample photographs used in this study.

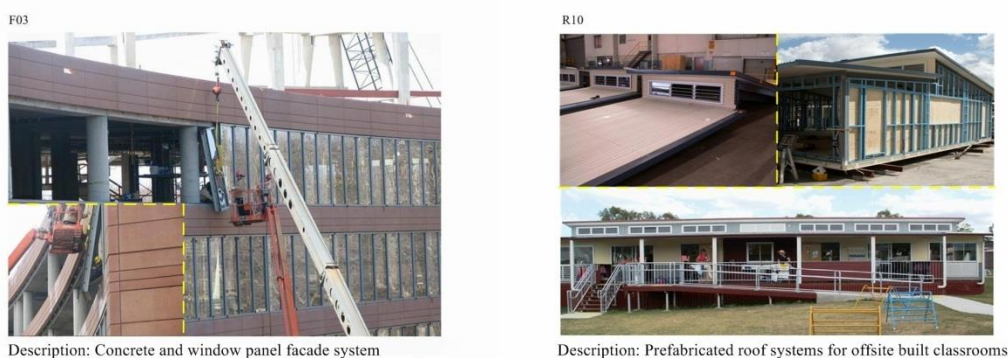

Figure 1: Sample photographs

P-set selection

Among various participants involved in a typical construction project, four participant groups were selected as participants, namely architects, engineers, constructors, and occupational health and safety (OHS) professionals. The underlying rationale is that they either participate in decision making concerning selecting a particular system/methodology (e.g. architect, engineers) or respond to the decision made (i.e. constructors, OHS professionals). In other words, these four participant groups have the most influence on or are most impacted by WHS risks implicit in design decisions. Q-methodology doesn't require a large number of participants as it aims to capture main viewpoints that are shared by a group of people (Watts & Stenner, 2005). The main study will have 20 participants from each group giving a total of 80 participants. For this preliminary study, 10 participants are involved for each group.

Condition of instruction

The 'Condition of Instruction' establishes the rules by which participants are asked to perform the sorting task. In this study, participants were requested to perform two rounds of photograph sorting for each building element. Participants were firstly instructed to sort the photographs into a grid according to their evaluation of the likelihood of an accidental injury arising when a depicted construction methodology is used. The grid contains five columns with a rating scale ranging from '-2 Rare' to '+2 Almost certain'. Then participants were asked to sort the photographs into another grid based on their judgements of the severity of consequential injury should an

accident occur. The rating scale ranges from ‘-2 Minor’ to ‘+2 Catastrophic’. After each round of sorting, respondents were asked a number of open questions to explain the reasons underlying the sorting patterns.

DATA ANALYSIS METHOD

This preliminary study provides a quick view to construction project participants’ risk perceptions. Nonparametric analysis methods were used to reveal the within and between group similarity/difference in risk perceptions related to the selected building systems. In this paper, two building elements were used as examples to present the data analysis results, namely façade and roof.

The within-group risk perception similarity/difference is assessed by the Kendall’s Coefficient of Concordance (W), which indicates the level of agreement regarding the ranking of photographs among participants of the same group. The between-group risk perception similarity/difference is measured by the Spearman’s Rank Order Correlation (r_s), which indicates the level of association between photo rankings ranked by different groups. The photo ranking was determined by the mean scores, which were derived from the ranking scores (i.e. -2 to +2) assigned to the photographs by participants of each group. The data analysis was processed with the statistic software of SPSS 21.0.

DATA ANALYSIS RESULTS

Within-group similarity/difference in risk perceptions

Table 1 shows the photo ranking and Kendall’s Coefficient of Concordance (W) within each professional group based on participants’ risk judgements for different façade systems. The results indicate that only the constructor group shows significant levels of within-group similarity ($W = 0.367$; $p = 0.001$) in the perceptions of the likelihood of risks associated with construction of the different façade systems. The other three groups have much discrepancy in the likelihood component of risk perceptions for the façade systems. Regarding the perception of the severity of any consequential injury in constructing the different façade systems, all four groups show significant levels of within-group similarities.

Table 1: Photo ranking and Kendall’s Coefficient of Concordance (W) for each professional group – Façade systems

	Façade – Likelihood							
	OHS		Constructor		Engineer		Architect	
	Mean score	Rank	Mean score	Rank	Mean score	Rank	Mean score	Rank
F01	.30	5	.10	5	-.20	1	.10	5
F02	.10	1	.40	8	.00	4	.00	4
F03	.60	8	.10	5	.20	6	.20	6
F04	.10	1	-.50	2	-.20	1	-.20	1
F05	.10	1	-.50	2	-.10	3	-.20	1
F06	.30	5	-.20	4	.10	5	.20	6
F09	.50	7	.30	7	.40	7	.30	8
F10	.10	1	-1.00	1	.40	7	-.20	1
Kendall’s Coefficient of	.128		0.367		.192		.082	

Façade – Severity								
	OHS		Constructor		Engineer		Architect	
	Mean score	Rank	Mean score	Rank	Mean score	Rank	Mean score	Rank
F01	1.70	7	1.20	7	1.00	3	1.20	5
F02	1.70	7	1.40	8	1.40	7	1.40	8
F03	1.10	3	1.10	6	1.40	7	1.20	5
F04	.90	2	.30	2	.80	2	.70	3
F05	1.10	3	.60	4	1.10	4	.90	4
F06	1.10	3	.80	5	1.10	4	1.20	5
F09	1.10	3	.50	3	1.10	4	.60	2
F10	.60	1	-.60	1	.20	1	-.70	1
Kendall's Coefficient of Concordance (W)	.309		.302		.326		.473	
Sig. (p)	.003		.004		.002		.000	

Table 2 indicates that all four professional groups show significant levels of within-group similarity in terms of likelihood and severity components of risk perceptions for different roof systems. The results indicate high level group homogeneity in risk perceptions regarding construction of alternative roof systems.

Table 2: Photo ranking and Kendall's Coefficient of Concordance (W) for each professional group – roof systems

Roof – Likelihood									
	OHS		Constructor		Engineer		Architect		
	Mean score	Rank	Mean score	Rank	Mean score	Rank	Mean score	Rank	
R01	-.10	4	.10	6	.40	5	.70	8	
R02	-.90	1	-.90	2	-.60	1	-.50	1	
R03	.10	5	-.20	4	.30	4	.50	7	
R04	.50	6	-.70	3	.70	6	.30	5	
R05	1.00	8	1.10	8	1.00	7	.10	3	
R06	.80	7	1.00	7	1.00	7	.30	5	
R09	-.40	3	-.20	4	-.10	3	.20	4	
R10	-.90	1	-1.00	1	-.50	2	-.50	1	
Kendall's Coefficient of Concordance (W)	.627		.642		.587		.332		
Sig. (p)	.000		.000		.000		.002		

Roof – Severity								
	OHS		Constructor		Engineer		Architect	
	Mean score	Rank	Mean score	Rank	Mean score	Rank	Mean score	Rank
R01	.80	3.00	.80	5	1.50	8.00	1.40	6
R02	-.70	1.00	-1.00	1	-.50	1.00	-.70	1
R03	1.00	5.00	.60	4	1.10	5.00	1.40	6
R04	.90	4.00	.20	3	.60	3.00	.60	4
R05	1.50	7.00	1.10	6	.90	4.00	.40	3
R06	1.60	8.00	1.70	8	1.30	6.00	.80	5
R09	1.00	5.00	1.10	6	1.40	7.00	1.40	6
R10	.20	2.00	-.70	2	.30	2.00	-.40	2
Kendall's Coefficient of Concordance (<i>W</i>)	.693		.606		.484		.672	
Sig. (<i>p</i>)	.000		.000		.000		.000	

Between-group similarity/difference in risk perceptions

Table 3 lists the results of Spearman's Rank Order Correlations between groups regarding risk perceptions related to construction of alternative façade systems. It shows that only the OHS group and Architect group share significant levels of similarity in the likelihood component of risk perceptions ($r_s = 0.902$; $p \leq 0.01$). No significant correlation is found between other groups regarding the likelihood judgement. The results suggest a high level of between-group difference in the likelihood judgement for risks associated with constructing the different façade systems.

Table 3 also shows that professional groups share much similarity in the severity judgment for risks associated with constructing the façade systems. Significant correlations were identified for OHS group and Constructor group ($r_s = 0.932$; $p \leq 0.01$), OHS group and Architect group ($r_s = 0.811$; $p \leq 0.05$), Constructor group and Engineer group ($r_s = 0.712$; $p \leq 0.05$), and Constructor group and Architect group ($r_s = 0.952$; $p \leq 0.01$). Surprisingly, no significant correlation was found between Engineer group and Architect group, which belong to the same functional group of designers. Nor was any significant correlation found between the OHS group and Engineer group.

Table 3: Spearman's Rank Order Correlations between groups – risk judgement for façade systems

Façade – Likelihood				
	OHS	Constructor	Engineer	Architect
OHS	1.000	.472	.368	.902**
Constructor	.472	1.000	.061	.677
Engineer	.368	.061	1.000	.422

Architect	.902**	.677	.422	1.000
Façade – Severity				
	OHS	Constructor	Engineer	Architect
OHS	1.000	.932**	.606	.811*
Constructor	.932**	1.000	.712*	.952**
Engineer	.606	.712*	1.000	.704
Architect	.811*	.952**	.704	1.000

** . Correlation is significant at the 0.01 level (2-tailed).
* . Correlation is significant at the 0.05 level (2-tailed).

Table 4 indicates that high similarity is shared between OHS group and Constructor group ($r_s = 0.807$; $p \leq 0.05$), OHS group and Engineer group ($r_s = 0.964$; $p \leq 0.01$), and Constructor group and Engineer group ($r_s = 0.819$; $p \leq 0.05$) regarding the likelihood judgement for risks related to construction of the selected roof systems. It is noticeable that the Architect group does not share any similarity with any of the other three groups.

Regarding the severity component of risk perceptions for the roof systems, significant correlations were noticed between the Constructor group and OHS group ($r_s = 0.898$; $p \leq 0.01$), Constructor group and Engineer group ($r_s = 0.755$; $p \leq 0.05$), Engineer group and Architect group ($r_s = 0.903$; $p \leq 0.01$). Correlations for other pairs of groups were not significant.

Table 4: Spearman's Rank Order Correlations between groups – risk judgement for roof systems

Roof – Likelihood				
	OHS	Constructor	Engineer	Architect
OHS	1.000	.807*	.964**	.412
Constructor	.807*	1.000	.819*	.461
Engineer	.964**	.819*	1.000	.467
Architect	.412	.461	.467	1.000
Roof – Severity				
	OHS	Constructor	Engineer	Architect
OHS	1.000	.898**	.503	.442
Constructor	.898**	1.000	.755*	.565
Engineer	.503	.755*	1.000	.903**
Architect	.442	.565	.903**	1.000

** . Correlation is significant at the 0.01 level (2-tailed).
* . Correlation is significant at the 0.05 level (2-tailed).

DISCUSSION OF RESULTS

The preliminary study has revealed some interesting findings in terms of professional groups' risk perceptions related to construction of a range of façade systems and roof systems.

It is found that participants share different levels of within-group similarities in risk perceptions for different building elements, i.e. they show more agreement on risk judgements for roof systems than for façade systems. A possible reason is that the construction process for façade systems is inherently more complicated than that of roof systems. Complicated construction processes introduce more variables or perspectives for participants to consider when making risk judgements. More variables or perspectives further lead to high discrepancy in participants' risk judgements. The result implies that professional groups' risk perceptions can be influenced by the different levels of complexity associated with the construction processes of different building elements.

The results of risk perception relating to constructing different façade systems revealed that there is no absolute within-group homogeneity in risk perceptions. Participants from the same professional group may view risk differently. This result is in accordance to previous researchers' arguments that risk perception is socially constructed, thus would be influenced by a wide range of factors (e.g. personal beliefs, attitudes and experience, contextual environment) apart from professional background (Pidgeon, 1998). The Constructor group is the only group that showed high level similarity in this round of judgement. This is because constructors are those who are actually engaged in the construction process, and therefore have a better understanding of the risks associated with constructing the façade systems than other groups.

The results of risk perceptions for façade systems also show that professional groups show more within-group difference in the likelihood component of risk perceptions than in the severity component of risk perceptions. One possible reason is that participants consider far more attributes/factors in the likelihood judgement for risks than in the severity judgement for risks. This was confirmed in participants' answers to the open questions, which were designed to explore why participants sort the photographs in a particular way. When judging the likelihood of risk, participants consider many attributes, including complexity of a system, level of machinery required, level of labour force involved, number of trades involved, the location of installation (e.g. external or internal), level of familiarity with a specific system, etc. However, when judging the consequence of risk, the main attributes considered are the impacts of a potential risks (e.g. first aid, hospitalization, single fatality, multiple fatalities).

Similar patterns were found for the between-group similarities/differences in risk perceptions, i.e. professional groups share higher between-group similarity in risk perceptions for the façade systems than for the roof systems, and they show more between-group difference in the judgement of likelihood of risks than in the judgement of severity of risks. The results could also be explained by the reason that construction of façade systems is more complex than construction of roof systems, and more factors can be taken into account for judgement of the likelihood of risks than for judgement of the severity of risks. It is also evident that the Architect group does not share significant levels of similarity with any other group in the likelihood

judgement for risks associated with constructing the selected roof systems. It is recommended that more risk-related communication should be conducted between architect groups and other professional groups. The input of other professional groups' risk perspectives will enable architects to have better understanding of potential impact of their design decisions on WHS in the construction stage, and thus better reduces or even eliminate risks at the design stage.

CONCLUSION AND FUTURE STUDIES

This study reported a preliminary analysis of within- and between-group similarity/difference in project participants' risk perceptions. An innovative photographic data collection method based on Q-methodology was designed for collecting data from four construction professional groups. Participants were requested to make risk judgements against the likelihood of any accidental injury relating to construction of a range of selected building systems as well as the severity of consequence should any accident happen. The research found that there is no absolute within-group homogeneity in participants' risk perceptions, which is indicated by the low Kendall's Coefficient of Concordance (W) values for ranking the façade systems in terms of the likelihood of accidental injuries. Nor distinct between-group difference was found, which was suggested by a number of significant correlations between groups regarding ranking the likelihood and magnitude of risks associated with constructing the building systems. The research results suggest that individual risk perceptions are not only shaped by knowledge, practice, and norms associated with a specific profession, but also influenced by a wide range of personal and social factors such as personal characteristic, belief, attitude, experiences and contextual environment. Therefore, participants from the same professional group may show different risk perceptions, while participants from different professional groups may share similar risk perceptions.

The understanding that risk perceptions are influenced by various factors suggests a multidisciplinary approach to risk management in the construction industry. Technical approach to risk analysis is inadequate to reflect the complete picture of risk. Risk should be interpreted as the integral of perceptions, social construction and object outcomes (Renn, 1998). In the construction project environment, risk management strategies need to consider the risk perceptions of all participant groups, whose have an impact or who could be impacted by risk assessment and control decisions. The results also have implications for the practical application of the concept of 'design for safety' in construction project. It is possible that a design solution perceived to be safe by one participant group may be perceived to be associated with high chance of injury by another participant group. It is recommended that all relevant project participants' risk concerns be communicated and considered in the design stage to achieve equitable and satisfactory WHS risk control outcomes.

In future, more comprehensive analysis will be conducted on a larger sample to provide a more robust insight into project participant groups' risk perceptions. For example, factor analysis with PQ-method will be conducted to categorize participants into different groups, within which participants share similar sorting patterns. Further, participants' responses to open questions will be systematically coded to reveal the various attributes/factors that participants used to make risk judgements. The coding results will also be used to characterize the groups identified from factor analysis.

REFERENCES

- Anandarajan, M., Paravastu, N., & Simmers, C. A. (2006). Perceptions of Personal Web Usage in the lace: AQ-Methodology Approach. *CyberPsychology & Behavior*, 9(3), 325-335.
- Arezes, P. M., & Miguel, A. S. (2008). Risk perception and safety behaviour: A study in an occupational environment. *Safety Science*, 46(6), 900-907.
- Atkinson, A., & Westall, R. (2010). The relationship between integrated design and construction and safety on construction projects. *Construction Management & Economics*, 28(9), 1007 - 1017.
- Baradan, S., & Usmen, M. A. (2006). Comparative Injury and Fatality Risk Analysis of Building Trades. *Journal of Construction Engineering & Management*, 132(5), 533-5339.
- Behm, M. (2005). Linking construction fatalities to the design for construction safety concept. *Safety Science*, 43(8), 589-611.
- Brown, S. R. (1980). *Political subjectivity: Applications of Q methodology in political science*. New Haven: Yale University Press.
- Lingard, H., Cooke, T., Blismas, N. & Kleiner, B. (2011). A socio-technical systems analysis of OSH decision-making in the early stages of construction projects', in Jack Davis (ed.) *Proceedings of CIB W099, Prevention: Means to the End of Construction Injuries, Illnesses, and Fatalities*, Washington DC, USA, 24-26 August 2011, pp. 1-16.
- Fairweather, J. R., Swaffield, S. R., & Simmons, D. G. (1998). Understanding visitors' experiences in Kaikoura using photographs of landscapes and Q method Tourism Research and Education Centre (TREC) report no. 5. Tourism Research and Education Centre, Lincoln University.
- Flin, R., Mearns, K., Gordon, R., & Fleming, M. (1996). Risk perception by offshore workers on UK oil and gas platforms. *Safety Science*, 22(1-3), 131-145.
- Gambatese, J. A., Behm, M., & Rajendran, S. (2008). Design's role in construction accident causality and prevention: Perspectives from an expert panel. *Safety Science*, 46(4), 675-691.
- Gambatese, J., & Hinze, J. (1999). Addressing construction worker safety in the design phase: Designing for construction worker safety. *Automation in Construction*, 8(6), 643-649.
- Gangoellis, M., Casals, M., Forcada, N., Roca, X., & Fuertes, A. (2010). Mitigating construction safety risks using prevention through design. *Journal of Safety Research*, 41(2), 107-122.
- Green, R. (2005). Community perceptions of environmental and social change and tourism development on the island of Koh Samui, Thailand. *Journal of Environmental Psychology*, 25(1), 37-56.
- Hallowell, M. (2010). Safety risk perception in construction companies in the Pacific Northwest of the USA. *Construction Management & Economics*, 28(4), 403 - 413.
- Hare, B., Cameron, I., & Duff, A. R. (2006). Exploring the integration of health and safety with pre-construction planning. *Engineering, construction and architectural management*, 13(5), 438-450.

- Holmes, N., Gifford, S. M., & Triggs, T. J. (1998). Meanings of risk control in occupational health and safety among employers and employees. *Safety Science*, 28(3), 141-154.
- Iavicoli, S., Natali, E., Deitingner, P., Maria Rondinone, B., Ertel, M., Jain, A., & Leka, S. (2011). Occupational health and safety policy and psychosocial risks in Europe: The role of stakeholders' perceptions. *Health policy*, 101(1), 87-94.
- Kleiner, B.M. and Hallowell (2012). Progress Report. Construction Industry Institute, University of Texas, Austin, TX.
- Pidgeon, N. (1998). Risk assessment, risk values and the social science programme: why we do need risk perception research. *Reliability Engineering & System Safety*, 59(1), 5-15.
- Stenner P, Watts S, and Worrell M (2008) "Q Methodology", In C Willig, and W Stainton-Rogers (Eds.), *The SAGE Handbook of Qualitative Research in Psychology*, Sage Publications Ltd, London.
- Surry, J. (1979) *Industrial Accident Research: A Human Engineering Appraisal*, Ontario Labor Safety Council, Toronto.
- Toole, T. M. (2002). Construction site safety roles. *Journal of Construction Engineering and Management*, 128(3), 203-210.
- Toole, T. M., & Gambatese, J. (2008). The Trajectories of Prevention through Design in Construction. *Journal of Safety Research*, 39(2), 225-230.
- Watts, S., & Stenner, P. (2005). Doing Q methodology: theory, method and interpretation. *Qualitative Research in Psychology*, 2(1), 67-91.
- Zhang, P, Lingard, H, Blismas, N, Wakefield, R and Kleiner, B (2013), Application of Q-methodology in studying construction stakeholders' perceptions of OSH risks - An introduction to the preliminary stage, in John V McCarthy AO, Stephen Kajewski, Karen Manley, Keith Hampson (ed.) *Proceedings of the 19th Triennial CIB World Building Congress, Brisbane, Queensland, 5-9 May 2013*, pp. 1-12.

OWNER VIEWS ON DESIGNER PARTICIPATION IN CONSTRUCTION SAFETY

Nicholas Tymvios⁶² and John A. Gambatese²

¹ *Dept. of Engineering Technology & Construction Management, University of North Carolina-Charlotte, 9201 University City Blvd, Charlotte, NC 28223-0001, USA*

² *School of Civil and Construction Management, Oregon State University, 101 Kearney Hall, Corvallis, OR 97331-2302, USA*

A major stakeholder in the construction industry is the owner. Owners have the drive, both conceptually and financially, to bring construction projects from the idea to reality. Construction owners can also greatly impact the safety performance on a project during construction through the methods and priorities with which they base their decisions when selecting contractors and designers. A study of construction industry owners was conducted using the survey method to investigate, identify, and rank criteria which owners use to select designers and contractors. These criteria included, among others, the contractor's safety record and the designer's active involvement in construction worker safety. The owners were also asked to provide their opinion on various topics regarding knowledge of Prevention through Design (PtD), the dangerous nature of the construction industry, and owner and designer participation in construction safety. The owner group selected for the study was universities in the US. Universities commonly construct, operate, and maintain many different types of construction projects including buildings and civil infrastructure. A total of 121 participants responded to the survey. The respondents are key personnel involved in the supervision, design, and construction of buildings on university campuses in 29 US states. The universities represented varied according to type of ownership (public and private) as well as in size. Initial analysis of the survey results reveals that there is an association between the ranking of the selection criteria and the organization's participation in construction safety. In addition, an association exists between the criteria ranking and the university's willingness for designers to be involved in construction safety. The study findings provide evidence of an owner's impact on construction safety, and in particular, implementation of the PtD concept. The findings indicate that further efforts are needed to involve owners in the diffusion of the PtD concept.

Keywords: construction, design, owners, prevention though design, safety, universities.

INTRODUCTION

To bring a construction project from concept to completion, several stakeholders need to participate and commit a large amount of time and effort. These stakeholders include owners (private or public) who provide the need for the project and the funding capabilities; the designers (architects, engineers, consultants, etc.) who turn guidance from the owners and into guidelines, drawings, and specifications for the

⁶² ntymvios@uncc.edu

constructors, the third major construction industry stakeholder, who in turn bring projects from design to completion.

The above description, though overly simplistic, has traditionally defined the responsibilities of each individual stakeholder group. Construction site safety, according to traditional US contracting methods, falls under the responsibilities of the construction contractors and their subcontractors, with minimal input from the other groups. In other countries, through guidelines and/or legislation, the responsibility for addressing construction site safety has been expanded to include owners and designers. Such efforts fall under the theme of Prevention through Design (PtD). According to Manuele (2008), PtD is defined as a process that integrates hazard analysis and risk assessment during the design and engineering stages of a construction project, by taking the necessary actions to reduce the risks of injury and damage to levels that are acceptable. Examples of government legislation enacted to promote PtD are the Construction Design and Management (CDM) regulations in the UK (Government 2007) and Spain's Royal Decree 1627/1997 (INSHT 1997). The governments of Spain and the UK brought about these regulations as part of a European Union (EU) initiative to curb the increasing number of work site accidents in all industries (EEC 1989; EEC 1992).

The introduction of PtD in the US construction industry occurred when the Construction Industry Institute (CII) sponsored a research project in the 1990's (Gambatese et al. 1997; Toole 2013). Since then the National Institute for Occupational Safety & Health (NIOSH) has started efforts to generate interest in the US and the PtD concept was incorporated in the National Occupational Research Agenda (NORA), a research program developed to encourage innovative research for improved workplace practices (CDC 2013). Even with all these efforts for PtD promotion, the US construction industry still remains unaware of the concept, and furthermore, some industry individuals seem to be set against the concept's implementation (Toole 2013).

To gain additional momentum in the promotion of PtD, the industry group that has been traditionally left marginalised on the topic of construction site safety needs to be informed on the topic. That group is the construction owners. Reasons for their lack of involvement in safety include an owner's lack of expertise and personnel to supervise construction. Owners would normally hire the project designers to supervise construction and these designers act as the owners' agents (Hinze 2001). Furthermore, owners also consider contractors and subcontractors to be the liable parties for safety during construction since they have the primary control of the construction site (Nwaelele 1996). Recent litigation proceedings though, have shown that increasingly owners can also be held accountable for accidents that occur on work sites (Nwaelele 1996; Hinze 2006; Huang et al. 2006).

PtD is a method for owners to increase their involvement in construction safety, as observed by the CDM regulations (Government 2007). Owners can also promote designer involvement in construction safety by requiring the designers who undertake their projects to also be actively involved. The research outlined in this paper describes the efforts that took place to identify what owners think of the PtD concept, their willingness to support PtD in the US construction industry, and their support of designer involvement in construction safety. These views were linked to criteria

owners use to select designers and construction contractors, and a profile of an owner that would be supportive of increased safety involvement was developed.

METHODOLOGY

Through the use of a survey, owners were asked to rank the criteria with which they select construction contractors and designers, and then answer several questions on the PtD concept, their views on construction safety, as well as their views on obstacles and enablers for the implementation of PtD in construction by designers in the US. To distinguish PtD efforts in construction from PtD efforts in other industries, the concept was introduced to the survey participants as Design for Construction Worker Safety (DCWS).

Owner group selection

Attempts were made to distribute the survey to several owner organizations in the US, but the groups contacted did not allow its dissemination to their members. This forced the research to concentrate on a particular type of owner. The researchers selected universities and colleges as the owner group because:

- They construct a variety of buildings such as educational buildings, office buildings, laboratories, athletic facilities, medical facilities, civil, retail, power generating facilities, etc.
- They use a variety of procurement methods which include Design-Bid-Build, Design-Build, Construction Management, and Construction Management at Risk. They also self-perform small projects.
- US universities are both privately and publicly funded, and both of these types were included in the study.
- Contact information for individuals responsible for design, supervision, and construction within the various universities can easily be obtained through internet searches. These individuals would have the necessary knowledge and expertise to answer the survey.

Individuals selected to respond to the survey were representatives from the various facility services, or equivalent departments within each university, who have the responsibility for administration, design, and supervision of the various construction projects.

To ensure geographic diversity in the selected universities, the states were grouped together according to the nine divisions established by the US Census Bureau, as shown in Figure 9. Within each group, at least half of the states were randomly selected. The 29 selected states used for the study are shown highlighted in Figure 10, and they are: Alaska, Arkansas, Colorado, Connecticut, Delaware, Georgia, Idaho, Illinois, Kansas, Kentucky, Maryland, Missouri, Maine, North Carolina, Nebraska, New Hampshire, New Mexico, Nevada, New York, Ohio, Oklahoma, Oregon, Pennsylvania, South Carolina, South Dakota, Tennessee, Virginia, Washington and Wisconsin.

The universities within each state were identified using the Peterson's Student Edge Website (Peterson's 2011), which maintains a directory of all universities in the US. The website stratifies the institutions as private and public, as well as in size according to their student population. The website lists 4 different sizes:

- Large Universities: more than 15,000 students
- Mid-Sized Universities: between 5,000 – 15,000 students
- Small Universities: between 2,000 – 5,000 students
- Very Small Universities: less than 2,000 students

For this research study, very small universities were not surveyed because the researchers considered very small universities to not have frequent or extensive construction projects.



Figure 9: US Census Bureau Grouping of US States

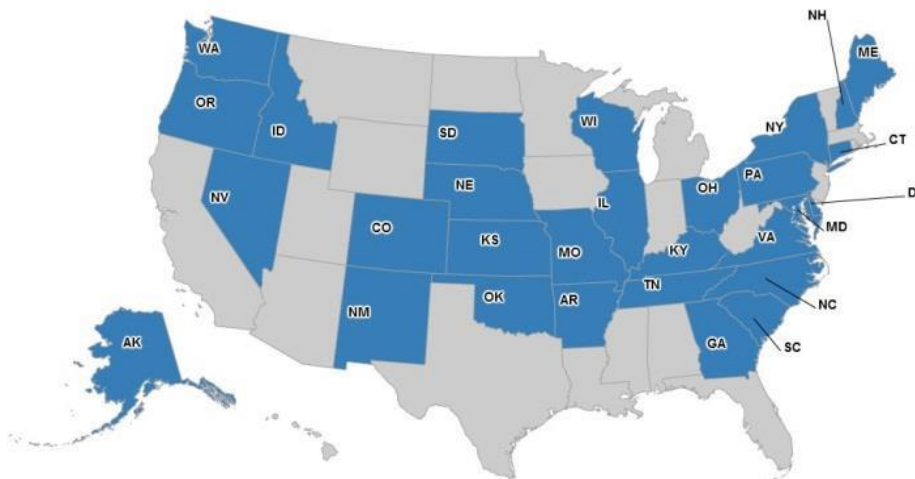

Figure 10: Selected States

Survey questions and distribution

The survey had four sections. The first section contained questions aimed at identifying the types of buildings the universities construct and the types of project delivery methods that they use. In addition, the university representatives were asked to rank, from a list provided, the criteria with which their universities select

construction contractors and designers. The list was developed based on a literature review and contained typical selection criteria used by owner organizations in the construction industry, such as bid price, past experience, safety record, etc.

The second section of questions aimed at identifying any previous knowledge participants had on the DCWS concept, as well as any participation their organization might have had in DCWS on the projects they completed.

The third section of the survey consisted of a series of Likert-type questions where responders were asked to identify their level of agreement or disagreement with statements regarding designers, owners, and safety in the construction industry. These statements addressed the level of understanding of each group on construction site operations, hazards to construction workers, capabilities and opportunities for education in construction safety, their possible involvement in construction safety, and their possible support of DCWS legislation.

The fourth and final section also included a series of Likert-type questions where responders were asked to state their level of agreement or disagreement to the existence of possible obstacles and enablers for designers to participate in DCWS that are currently in place in the US construction industry.

The survey was administered using the online survey tool "Limesurvey", which is a freeware computer program, administer by the Oregon State University College of Engineering. All the survey responses were stored on university servers and downloaded for analysis. All identifying information from participants was stripped from the responses prior to data analysis.

RESULTS

Survey responses

Five hundred and fifty four universities were identified in the 29 surveyed states, and individuals from 346 (62%) of these universities were identified and contacted. One hundred and twenty one individuals responded to the survey, providing a response rate of 35.1%. The distribution of the responses among the various states is shown in Figure 11. The distribution of university responses according to their size and ownership is shown in Table 9.

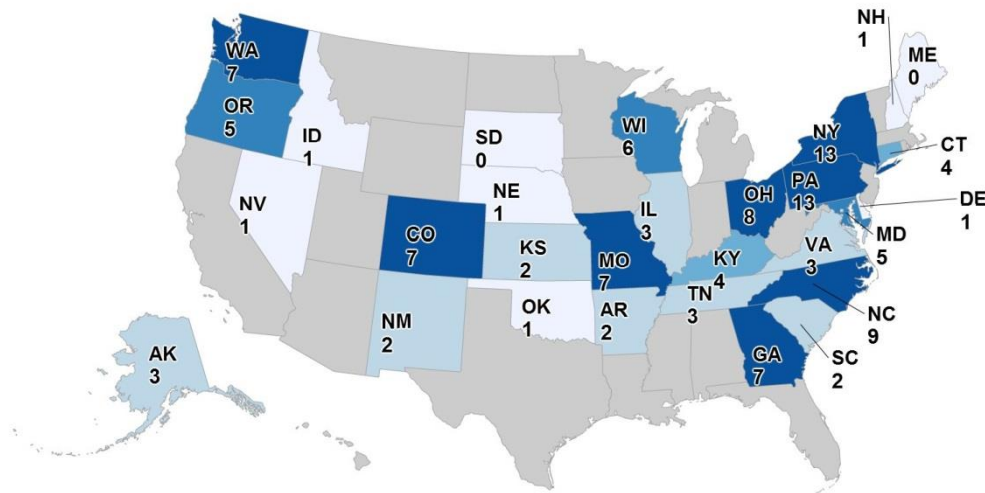

Figure 11: Distribution of survey responses

Table 9: Distribution of university responses according to size and ownership

	Small	Medium	Large	Total
Public University	17	46	24	87
Private University	21	13	0	34
Total	38	59	24	121

The data collected from the survey responses was analysed using SPSS. The ranking given by the respondents to the criteria for the selection of construction contractors and designers was of interest and in particular how the ranking relates to the responses to other questions.

The ranking of the criteria for construction contractor selection is summarized in Table 10 and designer selection criteria are summarized in Table 11. The numbers in the table indicate the participants selecting each criterion in ascending order. For example, the criterion "Project bid price" in Table 10 was ranked 1st by 50 participants, 2nd by 20 participants, 3rd by 13 participants, and so on. The "Mean Rank" column shows the average ranking of each criterion. As observed, in Table 10, the criterion with the highest rank was "Satisfaction with work from past project experience" with a rank of 2.5. The criterion with the second highest rank was "Project bid price" with a rank of 2.7. The criterion "Contractor safety record" was ranked 6th with an average rank of 5.1.

Table 10: Ranking criteria for selecting construction contractors by owners

Criterion	1st	2nd	3rd	4th	5th	6th	7th	Mean Rank
Satisfaction with work from past project experience	28	28	31	17	2	3	1	2.5
Prequalification requirements	25	26	22	11	9	10	5	3.0
Project bid price	50	20	13	9	13	13	2	2.7
Long-term contracting agreements	0	3	2	6	9	12	64	6.3
Contractor safety record	0	2	9	19	34	28	11	5.1
Technical ability of contractor	13	26	23	27	10	8	1	3.2
Trust in contractor personnel	5	10	11	17	28	24	9	4.5

Similarly for the criteria for the designer selection in Table 11, the criterion with the highest rank was "Satisfaction with work from past experience" with a value of 2.1. The criterion with the second highest ranking was "Prequalification requirements" with a mean rank of 2.4. The criterion "Designer's active involvement in construction safety" was ranked last (7th) with a mean rank of 5.9.

Table 11: Ranking criteria for selecting designers by owners

Criterion	1st	2nd	3rd	4th	5th	6th	7th	Mean Rank
Satisfaction with work from past project experience	42	39	18	13	2	0	0	2.1
Prequalification requirements	48	18	22	13	10	3	0	2.4
Design fees	2	11	18	16	31	16	9	4.4
Long-term contracting agreements	3	4	8	4	12	28	41	5.7
Designer's active involvement in construction safety	0	0	2	10	17	32	33	5.9
Technical ability of contractor	19	28	26	21	9	7	1	3.0
Trust in contractor personnel	5	15	18	30	20	9	8	4.0

To examine if there is a relationship between the ranking of the various criteria and the other questions within the survey, a chi-squared test using ordered contingency tables (2xk) was used as is described in the text by Le (1998). A similar treatment of data in safety surveys was performed by Camino López et al.(2008) and by López Arquillos et al. (2012). The ordered variables considered in this analysis were the ranking frequencies of each criterion, and these were compared against "Agreement" or "Disagreement" to the statements in the rest of the survey. Of interest were the criteria regarding safety, and these were "Contractor safety record" for construction contractor selection and "Designer's active involvement in construction safety" for designer selection.

Some of the more significant results regarding the ranking of the contractor's safety record included the following;

Contractor's safety record

Owners who ranked "contractor safety record" high in their selection criteria were also likely to state that their organization actively participates in construction worker safety ($p = 0.0011$). These owners were also likely to state that their "organization knows how construction site operations take place" ($p = 0.0107$), and agree that members in their organization have adequate capacity and opportunities to be educated in construction worker safety ($p = 0.0253$).

The same owners were also likely to state that the construction industry is a hazardous industry ($p = 0.04565$), and disagree that construction contractors are the only group currently involved in construction safety ($p = 0.02636$). They were also likely to agree that decisions made before ($p = 0.0304$) and during design ($p = 0.0183$) can eliminate construction site hazards.

Regarding obstacles to designers practicing DCWS, owners who ranked contractor safety records high in their selection criteria were likely to agree that there are "Ethical" ($p = 0.0440$) and "Cultural" ($p = 0.0298$) obstacles. Similarly they were also likely to state that there are "Regulatory" ($p = 0.0475$), "Economic" ($p = 0.0051$) and "Contractual" ($p = 0.0067$) incentives for designers to practice DCWS.

Designer's involvement in safety

Owners who ranked "Designer's active involvement in construction worker safety" high in their criteria for selecting a designer were likely to agree that decisions made before ($p = 0.0103$) and during design ($p = 0.0181$) can eliminate construction site hazards.

Regarding obstacles to designers practicing DCWS, owners who ranked designer's involvement in construction safety high in their criteria were likely to disagree that there are "Economic" ($p = 0.0117$) obstacles. Similarly they were also likely to state that there are "Regulatory" ($p = 0.0335$), and "Contractual" ($p = 0.0011$) incentives for designers to practice DCWS. Finally regarding support to legislation for DCWS, owners who ranked designer's involvement high also were more likely to state that their organization would be supportive of legislation that would require designers to practice DCWS ($p = 0.0092$).

CONCLUSIONS

The ranking of the criteria for the selection of both the construction contractors and the designers showed that safety is not the primary criterion for their selection by the owners. For contractors, their safety record was ranked sixth with a mean rank of 5.1, while for designers; their involvement in construction safety was ranked seventh with a mean rank of 5.9.

Owners who ranked safety high though, showed some characteristics that can be used to identify more progressive owners willing and able to promote DCWS and PtD in general. These owners would more likely be actively involved in safety in the construction projects they undertake, and employ personnel who are aware of how construction site operations and procedures take place. Such involvement might be through the use of personnel to supervise construction or requirements for contractors and designers to follow during the design and construction of a project that relate to

safety. Owners who have a high awareness of safety would also be providing opportunities for their employees to be educated in construction worker safety. A description of other examples that outline methods of how owners can be involved in safety can be found in a paper by Gambatese (2000).

Safety perception is also important in identifying owners who are willing to participate and promote PtD. Such owners would be aware that the construction industry is a hazardous industry. Because of this perception, they would also be aware that decisions made prior to the construction operations, such as prior to and during the design phases, can also affect safety. This correlation was identified both through the contractor and designer selection criteria. Regarding obstacles and enablers for designer PtD participation, owners identified that there are "Ethical" and "Cultural" obstacles, but also identified that there are "Regulatory" and "Contractual" enablers.

FURTHER RESEARCH

Lacking legislation requiring its implementation, to promote a more widespread implementation of PtD it is important to gain support for the concept by more industry participants. Owners are an important group to bring aboard, since they have the drive and motivation to generate construction projects through their needs and with the financial capabilities. Ultimately owners financially support designers and contractors, and if they see the value of implementing PtD in their facilities, they will request that their consultants design these facilities with PtD in mind. Methods to generate PtD interest for owners need to be identified and that can be achieved through the use of focus groups comprised of members who are aware of the PtD concept and see the value of its practice in construction.

REFERENCES

- Camino López, M. A., D. O. Ritzel, et al. (2008). "Construction industry accidents in Spain." *Journal of Safety Research* **39**(5): 497-507.
- CDC. (2013). "CDC - National Occupational Research Agenda (NORA)." Retrieved May 11, 2013, from <http://www.cdc.gov/niosh/nora/about.html>.
- EEC (1989). Council Directive on the introduction of measures to encourage improvements in the safety and health of workers at work. 89/391/EEC. EEC. Brussels, Belgium, EEC. **89/391/EEC**.
- EEC (1992). Council Directive on the implimentation of minimum safety requirements at temporary or mobile construction sites. 92/57/EEC. EEC. Brussels, Belgium, EEC. **92/57/EEC**.
- Gambatese, J. A. (2000). Owner Involvement in Construction Site Safety. Construction Congress VI: Building Together for a Better Tomorrow in an Increasingly Complex World, Orlando, FL, ASCE.
- Gambatese, J. A., J. W. Hinze, et al. (1997). "Tool to Design for Construction Worker Safety." *Journal of Architectural Engineering* **3**(1): 32-41.
- Government, H. M. s. (2007). The Construction (Design and Management) Regulations 2007. London, Her Majesty's Stationery Office.
- Hinze, J. (2001). Construction Contracts. New York, McGraw Hill.
- Hinze, J. (2006). Construction Safety, 2nd edition, Pearson Education, Incas Prentice Hall Inc.

- Huang, X. and J. Hinze (2006). "Owner's Role in Construction Safety." Journal of Construction Engineering and Management **132**(2): 164-173.
- INSHT (1997). REAL DECRETO 1627/1997, de 24 de octubre, por el que se establecen disposiciones mínimas de seguridad y salud en las obras de construcción. I. N. d. S. e. H. e. e. Trabajo. Madrid, Spain, Ministerio de Presidencia - Departamentos implicados.
- Le, C. T. (1998). Applied Categorical Data Analysis. New York, NY, John Wiley & Sons.
- López Arquillos, A., J. C. Rubio Romero, et al. (2012). "Analysis of construction accidents in Spain, 2003-2008." Journal of Safety Research **43**(5-6): 381-388.
- Manuele, F. A. (2008). "Prevention through Design (PtD): History and Future." Journal of Safety Research **39**(2): 127-130.
- Nwaelele, O. D. (1996). "Prudent owners take proactive approach." Professional Safety **41**(4): 27-29.
- Peterson's. (2011). "StudentEdge." Retrieved 11/8/2011, 2011, from <http://www.studentedge.com/studentedge/>.
- Toole, T. M. (2013). "Prevention through design, Concept." Retrieved May 11, 2013, 2013, from <http://www.designforconstructionsafety.org/concept.shtml>.

OWNERS' ROLE IN SAFETY PERFORMANCE IMPROVEMENT: A CASE STUDY OF CHINESE HIGH- SPEED RAILWAY CONSTRUCTION

Chunlin Wu ¹, Dongping Fang ¹, Feng Wang ², Minglai Xu ²

⁶³*(Tsinghua-Gammon) Construction Safety Research Center, Department of Construction Management,
School of Civil Engineering, Tsinghua University, Beijing 100084, China*

⁶⁴*Shanghai Railway Bureau, 80 Tianmu East Street, Shanghai 200071, China*

China has experienced almost a decade of large-scale high-speed railway (HSR) construction, in which onsite safety is one of the biggest challenges, especially in the earlier stage. Recent years have seen a significant improvement in HSR onsite construction safety, i.e. an obvious decrease of safety fatalities. A pilot investigation on several HSR construction sites by the authors found that commitment and input of the owner's senior management plays a dominant role in construction safety management. This paper aims to further justify owners' role in improving safety performance. Extensive structured interviews and focus group meetings are conducted to discover good safety management practices and institutions from the owner, the contractors, and the third-party supervisors. These practices and institutions actually came into effect after safety management was strengthened by the owner in recent years. Some key good practices are elaborated to analyse mechanisms in which they can improve construction safety performance. A managerial chain showing how owners can be fully and effectively engaged in project safety management is depicted. Results show that by providing human resources and institutional basis, implementing in-depth controlling of onsite safety and offering incentives and disincentives to stakeholders, the owner can make a difference in construction safety performance, as well as lead the contractor to increasingly stronger safety management capabilities. The findings will be of help for practical construction safety management to mitigate safety risks, or more specifically, to serve as a reference for the involvement of (senior) management in pursuing excellent safety performance.

Keywords: Safety; the owner; senior management; high speed railway construction.

⁶³ wuc11@mails.tsinghua.edu.cn

INTRODUCTION

The construction industry is reported, in the majority of countries, as having one of the highest occupational injury rates (Abudayyeh et al., 2006; Cameron and Duff, 2007; HSE, 2012; U.S. Bureau of Labor Statistics, 2012). In China, the number of occupational fatalities in construction increased significantly year by year. In 2011, 2634 people died of occupational accidents in construction, exceeding the death toll of any other industry, including coal-mining, which made it the most unsafe industry.

In recent years, the high-speed railway (HSR) construction scale in China is more and more considerable, much more than any other country in the world. HSR is a system consisting of rolling stock and infrastructure which normally operate at a speed of at least 250 km/h on new tracks, or 200 km/h on existing (conventional) tracks (UIC, 2010). It has various economic and social benefits, like passenger time savings, increase in passenger comfort, reduction in congestion, delays, traffic accidents and environmental externalities, thus attracting more and more investments. Currently, China is constructing more than 9000 km of HSR, even more than the total of the rest of the world (UIC, 2013). HSR is regarded as an indicator of technology advancement, both in the construction and operation stages. Due to the significantly greater train speed, HSR has higher and special requirements for its construction. Various features of HSR construction include more application of innovative skills, technologies and equipment, high proportions of viaduct & tunnel construction⁶⁵, considerable investment and tight schedule, and more concurrent processes, etc., most of which can lead to safety risks for the workforce. For example, there is considerable application of innovative technologies and equipment which are not familiar to ordinary construction teams, especially the migrant rural workers, and any improper operation can lead to safety and quality hazards. The higher proportion of viaduct construction results in more lifting and working at heights with large construction equipment, which increases the probability of such major safety accidents as falls from height and equipment overturns. In addition, more concurrent processes resulting from high project complexity requires excellent construction organization. If construction is not well planned or organised, the site will easily be out of control, which in turn leads to safety incidents.

However, despite such a large scale and high complexity, Chinese HSR construction has a fairly good occupational safety performance in the past few years, contrary to the generally negative safety situation over the whole Chinese construction industry. From 2007 to 2012, the number of fatalities in HSR construction declined by 63.5%. What are the drivers, or root causes, of this safety performance improvement? This is a very interesting research issue, and its results may have the potential to provide useful reference and implications for the whole construction industry to mitigate safety risks.

A PILOT INVESTIGATION

In order to discover the root causes of safety performance improvement in Chinese HSR construction, we carried out a pilot investigation on some Chinese HSR

⁶⁵The reason of the high proportion of viaduct & tunnel construction is that HSRs usually have to go through very rough terrains, like mountainous and hilly regions, because of the curvature demand. The curvature should be set at very low levels in order to keep the trains at high speeds, so the line directions cannot be freely changed. Numbers of ups and downs should also be critically controlled along the line. Because of this, viaducts and tunnels are very popular in HSRs.

construction projects. These projects belong to a single governmental institution, i.e. Shanghai Railway Bureau (SRB), which is in charge of railway construction and operation within Yangtze River Delta Economic Zone, the most developed and populous area of China. SRB has many branches, namely project management organisations (PMOs⁶⁶) of railway construction and operation, and thus can be seen as the HSR owners' headquarter. Till July 1st, 2013, SRB has completed and is operating 2191.8 km HSR, 22.5% of the national total scale. Despite such a large construction scale, SRB has still made very significant progress in HSR construction safety in the past few years. In 2007, there were 37 deaths in its HSR construction, but in 2012, the number was 0. SRB's construction safety progress is even more significant than that of the whole national industry.

The pilot investigation included several focus group meetings and semi-structured interviews involving major members of various HSR construction projects in the charge of SRB. Participants of our pilot investigation include senior management of SRB and its PMOs, project managers of the contractors, onsite supervisors and average workers. They are asked to list their perceived key factors of construction safety performance improvement and the most significant management features shared by SRB HSR projects.

In the focus group meetings and interviews, most participants pointed out one common factor influencing safety performance of their projects; that is, the full engagement of the owner's senior management, especially from the SRB headquarter. Since 2007, by the emphasis and promotion of the senior management, a series of effective safety management measures and initiatives were implemented, reinforced safety monitoring risk mitigation, and effectively prevented the occurrence of safety accidents. The most significant management features of SRB projects is the detailed and comprehensive safety management of the owner in the project level that is mentioned most frequently. Most participants, especially the contractor party, revealed the fact that in order to combat the high safety risks brought by the unprecedentedly considerable HSR construction in recent years, senior managers of SRB displayed a strong and constant management commitment and input to HSR construction safety. The leading role of the owners in construction safety management in turn developed a strong safety culture all through HSR projects of SRB, promoted a series of effective and innovative management measures, and enhanced workers' safe behaviour and onsite environment.

A number of previous studies validated the significance of the owners' involvement to project safety performance (Gambatese, 2000; Huang and Hinze, 2006a; Huang and Hinze, 2006b; CURT, 2012). It is generally assumed that during construction the contractor shoulders most of the responsibility for worker safety. If a contractor has been carefully selected, with safety as a criterion, and if the contract contains provisions that stress the importance of safety, the continued involvement of the owner need not be extensive. However, the owner's involvement in the safety effort will continue if worker safety is truly the objective of the owner. That involvement is especially important when the construction firm, i.e. the contractor, is not fully committed to safety. At present, the Chinese HSR industry is still at its early stage. Compared with high social and economic demands, construction capabilities of construction enterprises, i.e. contractors, relatively lag behind. Onsite safety is one of

⁶⁶The PMO is the actual owner of a HSR construction project.

the biggest challenges, and construction firms generally lack the competency to effectively deal with safety issues. Because of their deepest and most comprehensive understanding of project features and specifications, owners have the most abundant resources (especially human resources) and information to lead safety management development of the whole industry. Therefore, it is possible that the owners' engagement in project safety management can make up for the managerial deficiency of the contractors, and lead them to be more competent for HSR construction safety management.

This study aims to explore the owners' functions in influencing construction safety performance by a case study on Chinese HSR construction projects. It is to collect specific safety managerial measures promoted by the owners, and preliminarily analyse how these measures improve safety performance. Findings of this research can provide useful implications for management practices of the construction industry.

METHOD

The major aim of the paper is to establish the role of owners in improving project safety performance in the construction industry. Based on the pilot study, the formal study aimed to establish good safety management practices from SRB's HSR construction projects.

Procedures

In order to fully understand HSR construction safety management practices of SRB, so as to extract their theoretical contributions, we made a thorough investigation on almost all branches, or PMOs of SRB, to discover good safety management practices from HSR construction projects. Based on the pilot investigation, we found out that it is the new safety management practices generated by SRB managers since the year of 2007 that mainly led to the significant safety performance improvement of high-speed railway construction projects. Good practices we discovered met the following three principal criteria: 1) are effectively applied in, and significantly improve safety performance of the investigated SRB HSR construction projects, 2) have not been put into practice in previous HSR construction projects in China, and; 3) can be borrowed from other kinds of projects than railway construction, and have been successfully used in the investigated projects. As supplementary conditions, good practices can arise from previous practices which have been improved, reinforced or integrated, and produce much better management effects than before.

Good practices are discovered in three layers. The first layer is the construction management of SRB, which means safety management policies and measures initiated by SRB headquarter, or behavioural practices of SRB top management. Those policies, measures, and behavioural practices cover all HSR construction projects of SRB. The second layer is PMOs, which can carry out innovative safety management practices adapting to specific conditions of their own projects. The third layer is the contractors and third-party supervisory engineers of HSR construction projects. They are the main force of the engineering construction, and only with their efforts can the owners' policies and measures be put into real practice. By learning about onsite real implementation, we can have an unbiased understanding of the functioning mechanisms and final effects of good safety management practices we discovered. Moreover, based on the owner's safety management policies and requirements,

contractors and third-party supervisory engineers can also promote their own managerial innovations.

A safety management system (SMS) framework was built to make our investigation as complete and structured as possible. The framework contains nine categories of safety management, i.e. leadership and culture; policies, strategies, and objectives; organisation, documents and resources; safety risk management; planning; human resource management; working with contractors and third-party supervisors; implementation and monitoring; auditing and reviewing. The structure of the framework and interrelationships within are shown in Figure 1 (CURT, 2012).

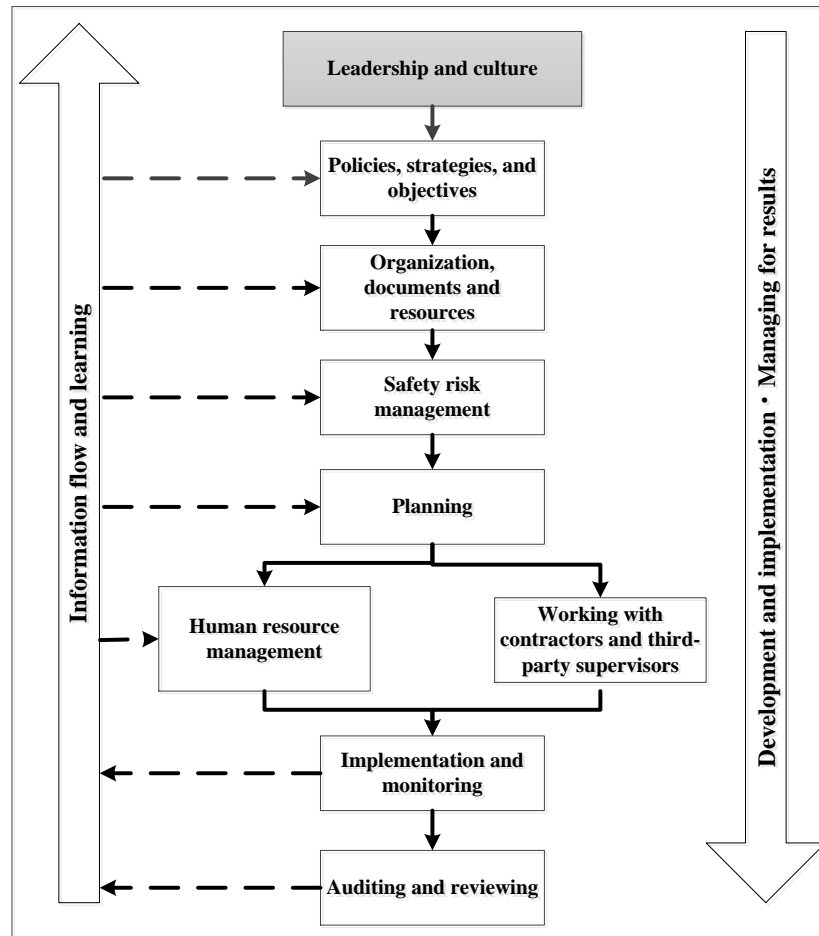

Figure 1: Framework for the discovery of good construction safety management practices

Research tools

Various research tools were used to discover HSR construction good safety management practices, including archival studies, focus group meetings, questionnaire surveys, structured and semi-structured interviews, and site observations, which were applied on different levels of management in different project stakeholders, i.e. the owners, the contractors (including subcontractors), and third-party supervisors. In particular, in the structured interviews, a suite of interviewing questions for each category shown in Figure 1 was designed. For instance, in the category of leadership and culture, interviewing questions include “Does the management (especially the senior management) positively and actively involved in safety management activities.

If it is the case, give some examples”, “what is the priority of safety when it is compared with cost and time; what is your attitude toward cost increase brought by extra safety promotions?”, etc. In the category of safety risk management, interviewing questions examples include “are there any practical onsite approaches to make safety risk management policies and requirements more feasible and effective, especially among the labour force, which tend to have poor safety knowledge and awareness?”, “are there fixed procedures to constantly update safety risk evaluation results, and how to respond to new safety risk factors and mitigating approaches?”. More than 100 questions were designed to deeply discover good safety management practices we want.

Participants

Table 1 shows the positions and numbers of the participants in our investigation. Almost all key personnel in charge of safety management in the three project stakeholders were involved. A total of 77 managers in key positions, including senior management, superintendents and foremen of different stakeholders, participated in our focus group meetings and questionnaire surveys, or were interviewed face to face by us. Discovery of good safety management practices lasted from October 2012 to May 2013.

Table 1: Participants in the phase of discovery of good practices

Stakeholder	Name of organisation	Position	No. of participants	Sub-total
Owners	SRB	Director in charge of construction	1	50
		Head and deputy heads	6	
	Construction department of SRB	Members	5	
		Senior management	7	
	PMOs	Chief engineers	3	
		Head of the department of HSE	16	
		Head of the department of construction management	2	
		Members of the department of HSE	10	
Contractors	Contractors	Project managers	6	16
		Onsite safety managers (superintendents)	6	
		First-line supervisors and foremen	4	
Third-party supervisors	Third-party supervisors	Chief supervising engineers	6	11
		Supervising engineers	5	

RESULTS AND DISCUSSION

A total of 60 good construction safety management practices were established and synthesised, after as long as eight months’ comprehensive investigation on SRB’s HSR construction projects. Each of these good practices was carefully screened according to the criteria we mentioned above. These good practices had come into project management practice for a long time, been accepted and taken in by the personnel with fixed procedures and regulations. They can significantly improve

safety performance, even though they may have more or less negative effects on cost, schedule, or other kinds of project performance. In the following part, we elaborate some key good practices and their implications for the owners' on-site safety management, in order to understand what have led to safety performance improvement, and how they took effect.

Safety commitment of the senior management

One of the main good practices we discovered can be expressed as “the senior management sets safety as the first priority of SRB, and guarantee this priority by considerable safety commitment and input”. This is the theme and guiding principal of SRB's HSR construction safety management. Management commitment is one of the most common dimensions of safety culture/climate, and ranks the first in the safety culture/climate factor structure (Fang et al., 2006; Fang and Wu, 2013; Guldenmund, 2000), so it plays a crucial role in safety performance improvement. Under the influence of the senior management's charisma and strong appeal to high safety performance level and the well-being of subordinates, the staff on all organisational levels, including front-line workforce, can focus on the endeavour of safety promotion, and have strong beliefs in and awareness of working safely. “Defending the health and safety of the staff” is the principal initiative promoted by SRB's senior management, and in order to put it into real practices, the senior management took various measures by themselves. For example, they ensure their regular and substantial visibility on the site during the execution of the project. Especially at the time of kick-offs, the senior managers of SRB and its PMOs must be present on the site, and hold all-personnel meetings, in which safety objectives and requirements are stressed out. The senior management guarantees a safety responsibility system taking effect in the very beginning of project execution and taking care of all weak links of safety controlling afterwards. Due to the special construction time arrangement of HSR projects, night work cannot be avoided. Compared with daytime, night is when construction accident rates increase significantly, due to the natural exhaustion of workers, poor light conditions, and general absence of supervisors. In view of this weak link of safety controlling, the senior management takes the so-called “midnight actions”, i.e. making sudden and unexpected visits to the construction sites to inspect safety risks and hazards at that time. This measure can not only discover construction unsafe factors effectively, but also remind the onsite personnel of the importance of safety precautions and controls at the special time. The successful display of owners' management safety commitment to the frontline workforce of contractors can motivate voluntary safety involvement and participation, which have more significant and profound impacts on safety performance than simple safety compliance (Griffin and Neal, 2000; Griffin and Hu, 2013).

Owners' full engagement in project safety management

All stakeholders, including workers, bear responsibility for creating and maintaining safe construction workplaces. Owners can play a key role in influencing the safety performance that is ultimately realised on construction projects. As the Construction Users Roundtable (CURT) (2012) believe and promote, in safety management, construction owners hold the greatest leverage, which is the leadership and authority to influence the behaviour and regulations of the others. For this reason, owners are the best candidates to lead the construction industry toward consistent achievement of safe projects. To the Chinese HSR industry, compared with high social and economic

demands, construction capabilities of construction enterprises, i.e. contractors, relatively lag behind. Because of their deepest and most comprehensive understanding of project features and specifications, owners have the most abundant resources (especially human resources) and information to lead safety management development of the whole industry. Thus, in the current days, owners' full engagement in project safety management not only is crucial to safety performance improvement, but also drives safety management innovation of their stakeholders, and eventually improves the management level of the whole industry. Figure 2 show how the owners are fully engaged in project safety management driven by their strong safety commitment (rectangle boxes refer to good practices; circles and in-between arrows depict the managerial chain implicated by interrelated good practices).

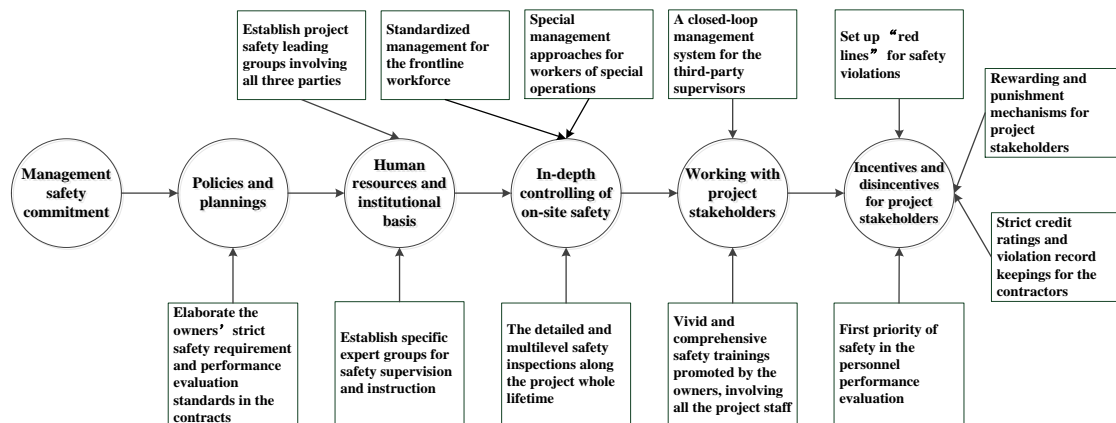

Figure 2: Owners' full engagement in project safety management

The nature of role played by owners begins with the establishment of a clear objective concerning safety. By elaborating their strict safety requirements and performance evaluation standards, owners can convey this clear objective to the contractors and third-party supervisors. With significant managerial advantages over other parties, owners can give the project a secure human resources and institutional basis by bringing in expert groups and designing new organisational structures. With the established policies, planning, and human resources and institutional basis, owners can carry out in-depth controlling of on-site safety either by themselves or by working with stakeholders, i.e. contractors and third-party supervisors, as shown in Figure 2. This managerial chain ends up with incentives and disincentives for project stakeholders, which are important contractual means for performance management.

CONCLUSIONS AND FUTURE RESEARCH

Safety has gradually been accepted as the top priority of construction project organisations, but many construction firms cannot fulfill their promises for safety because of their incompetency in reconciling contradiction between safety and cost. In this situation, the role of owners is of vital importance to project safety performance improvement. Results of the pilot investigation on HSR construction projects of a single owner headquarter (SRB) reminded us that owners' safety initiatives is the major factor leading to safety performance improvement. We then made a considerable investigation for the discovery of good safety management practices to

find out specific ways in which the owners can engage in project safety management, like displaying strong safety commitment, setting very specific safety goals and expectations in the contractual files, providing excellent human resources and favorable institutional basis, implementing in-depth controlling of onsite safety by themselves or by working with contractors and third-party supervisors, and offering incentives and disincentives for project stakeholders, etc. Our study revealed that an owner can make a difference in contractor safety performance, as well as lead the contractor to increasingly stronger safety management capabilities.

It should be noted that the generation and successful implementation of good safety management practices have to be largely attributed to the strong leadership of people in major positions of SRB. Most participants of our investigation mentioned that in order to combat the high safety risks brought by the unprecedentedly considerable HSR construction in recent years, senior managers of SRB displayed a strong safety leadership by making constant and intense management commitment and providing input to HSR construction safety. Such good practices as “the senior management sets safety as the first priority of SRB, and guarantees this priority by considerable safety commitment and input” which embody safety leadership, were also regarded as the driving factor of the other good practices. Thus, it is also of great significance to probe into the fundamental role of safety leadership in SRB’s HSR construction safety management. Future research can further explore how leadership from owners improves project safety performance by promoting specific safety management measures. This issue is evidently more casually precedent than what is researched in this study.

ACKNOWLEDGEMENTS

Acknowledgments are addressed to the Natural Science Foundation of China (Grant Nos. 71172013 and 50978155) and the China Ministry of Education (Grant No. 20090002110044), and Shanghai Railway Bureau (SRB) of China, its staffs, its project management organisations, its contractors, subcontractors and third-party supervisors for their support and participation in the consulting project.

REFERENCES

- Abudayyeh, O, Fredericks, T K, Butt, S E, Shaar, A (2006) An investigation of management’s commitment to construction safety. “International Journal of Project Management”, 24, 167-174.
- Cameron, I, Duff, R (2007) A critical review of safety initiatives using goal setting and feedback. “Construction Management and Economics”, 25, 495-508.
- Fang, D, Yang, C, Wong, L (2006) Safety climate in construction industry: A Case Study in Hong Kong. “Journal of Construction Engineering & Management”, 132(6): 573-584.
- Fang, D, Wu, H (2013). Development of a Safety Culture Interaction (SCI) model for construction projects. “Safety science”, 57, 138-149.
- Gambatese, J A (2000) Owner involvement in construction site safety. In: “Construction Congress VI @ Building Together for a Better Tomorrow in an Increasingly Complex World”, February 2000, ASCE, 661-670.
- Griffin, M A, Hu, X (2013) How leaders differentially motivate safety compliance and safety participation: The role of monitoring, inspiring, and learning. “Safety Science”, 60, 196-202.

- Griffin, M A, Neal, A (2000) Perceptions of safety at work: a framework for linking safety climate to safety performance, knowledge, and motivation. "Journal of Occupational Health Psychology", 5, 347-358.
- Guldenmund, F W (2000) The nature of safety culture: a review of theory and research. "Safety science", 34(1), 215-257.
- Health and Safety Executive (2012) "Construction: Work related injuries and ill health", available at: <http://www.hse.gov.uk/statistics/industry/construction/construction.pdf> (accessed October 2012).
- Huang, X, Hinze, J (2006a) Owner's role in construction safety. "Journal of construction engineering and management", 132(2), 164-173.
- Huang, X, Hinze, J (2006b) Owner's role in construction safety: Guidance model. "Journal of Construction Engineering and Management", 132(2), 174-181.
- UIC (2010) "General definitions of highspeed", available at: www.uic.org/spip.php?article971 (accessed 19 January 2011).
- UIC (2013) "High speed lines in the world", available at: <http://www.uic.org/spip.php?article573> (accessed 1 November 2013).
- U.S. Bureau of Labor Statistics (2012) "Numbers of nonfatal occupational injuries and illnesses by industry and case types", available at: <http://www.bls.gov/iif/oshwc/osh/os/ostb2815.pdf> (accessed 29 March 2012).

SME-MICRO ENGAGEMENT WITH OCCUPATIONAL SAFETY AND HEALTH (OSH) - THE ROLE OF THE OWNER-MANAGER.

Aoife Finneran⁶⁷, Elaine Yolande Gosling¹, Alistair Gibb¹, Phil Bust¹

¹ *School of Civil and Building Engineering, Loughborough University, Loughborough, United Kingdom*

The heterogeneous nature of Medium, Small and Micro enterprises (SMEs and Micros) means that standard definitions of what they are may be difficult to use in practice; this in turn complicates data collection. The standard definition used by the European Communities for headcount can facilitate data collection in order to classify the enterprise size as Medium, Small or Micro. In addition to the definition of size, access to participants in SME-Micros can also be difficult. This paper reviews current literature investigating the role of the Owner-Manager and factors that facilitate and inhibit SME-Micros engagement with OSH, including access to and translation of OSH information. This paper presents emerging findings from a study investigating OSH engagement among SME-Micros (≤ 250 employees). Emerging findings reveal issues with OSH information and legislation translation; the different OSH information needs of SME-Micros and the importance of the Owner-Manager.

Keywords: SMEs, Micros, Owner-Manager, OSH

INTRODUCTION

SME-Micros continue to be a major economic contributor globally, yet little is known about how they interact with occupational safety and health (OSH) information and knowledge. Research in this area is difficult for several reasons; including defining the SME-Micro and access to relevant cohorts. This paper investigates the definition of SME-Micros. Using qualitative methods (interviews and focus groups) researchers will investigate OSH engagement among SME-Micros across several sectors including construction, to help develop present sources of guidance and facilitate them in being more relevant to SME-Micro enterprise needs. Through research funded by the Institution of Occupational Safety and Health (IOSH), results will be compared across industries to develop best practice guidelines for OSH engagement for SME-Micros.

Definition

In May 2003 the Commission of the European Communities issued a document to standardize the definition of SME-Micros across the European Union (European Commission, 2003). This was based on the idea that the existence of different definitions could create inconsistencies in relation to legal standing, or cause distortion when structural or research funds were allocated. The Commission defined an enterprise as “any entity, regardless of its legal form, engaged in economic

⁶⁷ a.m.finneran@lboro.ac.uk

activities, including in particular entities engaged in a craft activity and other activities on an individual or family basis, partnerships or associations.”

To help define SME-Micros the Commission offers criteria in terms of staff headcount and financial turnover, the economic thresholds are subject to scaling and updating. However, staff headcount is undoubtedly the most important and should be observed as the main criterion. Walters (2001) also classified enterprises according to size with the same numerical values as the commission.

Table 1 European Communities Criteria for SME s and Micros

Enterprise category	Headcount: Annual Work Unit (AWU)	Annual turnover	Annual balance sheet total
Medium-sized	<250	≤€50 million	≤€43 million
Small	<50	≤€10 million	≤€10 million
Micro	<10	≤€2 million	≤€2 million

However, there are further criteria to determine if an enterprise fits into one of these categories, for example, it must be autonomous, it cannot be considered an SME-Micro if 25% or more of its voting rights are directly or indirectly controlled by one or more public bodies. The composition of staff headcount is also important, for example, part-time and seasonal workers may be considered in headcount, but those on internships or student placement may not. However, while several criteria are given and the European Commission definition has legal standing within Europe, there is no universal definition of what constitutes an SME-Micro (Legg et al., 2009). There are a number of reasons for this lack of consensus: SME-Micros are found across the entire spectrum of enterprise activity and so cannot necessarily be defined by a singular industrial sector. Moreover, SME-Micros can adopt several characteristics which may make them difficult to define legally. One distinguishing characteristic for SME-Micros is that they are often managed by the owner (Great Britain Committee of Inquiry on Small Firms, 1971). The concept of Owner-Management usually forms the basis of most definitions of the SME-Micro. This concept may be used to consider the terms Owner-Managed and Owner-Manager. The first, Owner-Managed, describes a situation where the owner takes on several roles within the enterprise and will often not seek specialist advice unless there is an inherent need. Where advice is supplied this is often through an external consultant who may have no pre-existing relationship with the enterprise (Lansdown et al., 2007). The latter, Owner-Manager may, for example, refer to a franchisee where the owner may have access to resources, guidance and management practices from a larger enterprise. Owner-Manager may also refer to a subcontractor working within a larger project network. Eakin et al., (2000) have also touted the term Owner-Operator, a theme common in construction as workers often own their own tools. However, the definition may also be extended to healthcare or logistics, for example; in healthcare a physiotherapist who owns their own equipment or in logistics, a driver who owns their own vehicle. The heavily subcontracted nature of the construction industry may confound OSH responsibility and render the worker’s employment status ambiguous and force them to take on the responsibility of Owner-Operator. The Owner-Manager can be viewed as the key person in an SME-Micro as it is their values and views that determine the approach to OSH management (Antonsson, 2007; Hasle and Limborg, 2006; Baldock et al., 2006).

SME-Micros in construction have proportionally more accidents than larger enterprises (Waters, 2001; Brace et al., 2010), leading many to the conclusion that SME-Micros are not engaging with OSH. However, Crawford et al., (2013) argue that this reputation of SME-Micros is undeserved as there are signs of good and bad OSH performance and engagement. Lansdown et al (2007) identified three types of smaller companies each requiring differing interventions to stimulate engagement with OSH knowledge: unaware-inactive, anxious-active and confident-active. However, Brace et al, 2009 argued that many micro organisations are really glorified DIY workers who perceive that they have little time or resource to engage with OSH at all, even if they knew how to access the information on good practice. This study of fatal accidents in construction argued that micros were often 'risk acceptors' and were particularly difficult to reach through normal OSH dissemination channels. The work proposed that access through Builder's Merchants or the LA Building Control Officers may provide new and effective channels of communication.

OSH Knowledge in SME-Micros

Workers in SMEs want to be safe at work and trust their own safety knowledge developed over years of work (Wadick, 2007). There is also evidence that Micros have more freedom-authority, autonomy and opportunity to choose good working methods. Wrnieniewski and Dutton (2001), highlight that it may be necessary to take advantage of this to help Micros manage their safety knowledge more efficiently. However, Wadick (2007) also argues that Micros, in the construction industry, have a poor understanding and appreciation of OSH legal requirements and accept that the work is inherently dangerous, tending to think of safety as 'common sense' and blaming the injured worker for not being careful enough. Hasle et al., (2012) cite that most Owner-Managers take a positive approach to OSH, but also try to talk down risk and criticise regulation as bureaucracy, as well as pushing part of the responsibility on to employees. However, Hasle et al., (2012) highlight that the Owner-Manager is important in terms of defining OSH culture, it may not be that at the Owner-Manager is taking a common sense approach; instead they try to follow what they experience as a generally acceptable standard for the working environment among stakeholders in a given sector. Reasons for the downgrading of risk and a push of social responsibility onto the workers can be found in the close social relationships and the identity process of the Owner-Manager with their business. Given the close working relationships Owner-Managers generally try to act as responsible people and thus avoid personal guilt and blame if employees should get injured. However, if employees are close friends or family members it is also possible that they may be more accepting of a more ad hoc approach to OSH. There is also evidence to suggest that Owner-Managers seek to recruit more diligent workers whom they trust (Hasle and Limborg, 2006), and that the close physical proximity of the work can allow the Owner-Manager to detect risky behaviour (Pedersen et al., 2011). Knuckey et al., (2002) suggest that as the enterprise becomes larger the lines of communication and operating procedures automatically become more formal. It has also been suggested that once an enterprise begins to employ more than 20 employees it takes on a more formalised management structure (Wilkinson, 1999; Heddal, 2002). However, Legg et al., (2009) suggest that need for more formalised structures may come at a cut-off point of as low as 10 to 12 employees. In terms of the European Communities this would imply that Micros may have an informal management style.

The SME-Micro sector is vastly different from that of larger enterprises, even if some of the hazards are the same. Legg et al. (2009) highlight that it may be unwise to take view SME-Micros as 'mini larger' enterprises, or that they might evolve into larger enterprises. SME-Micros by their nature are heterogeneous in terms of; employment sector, management processes, and outputs (Breakwell & Petts, 2001). Business processes in SME-Micros are complex and intertwined. Owner-Managers take on several critical business roles which, in larger enterprises, may be delegated to specific and/or specialised staff. There is little evidence to suggest that interventions modelled around good practice in larger enterprises are applicable in SME-Micros (Lansdown et al., 2007). This could lead to a number of shortcomings, such as poor 'offer of intervention' timing, inappropriate stage of development for the enterprise, poor relevance, and/or a lack of marrying the needs of business and type of intervention (McKinney, 2002). SME-Micros may be less likely to have performance protocols in place to measure the effect of interventions (Lansdown et al., 2007): it may be that Owner-Managers have other work critical issues to oversee and as such OSH issues are not high, or high enough, on the agenda (Crawford et al., 2013) and it has also been reported that Owner-Managers are highly susceptible to stress and burnout (Hasle and Limborg, 2006). Failure to implement and monitor interventions is exacerbated in SME-Micros by lack of fiscal capital, work/job knowledge and human resources (Garengo, Baize, & Biotitic, 2005). Mayhew (1997) proposes that SME-Micros may also have difficulty translating legislation, not just in terms of how a complex set of text can be enacted, but also how it fits in with business processes (Toone, 2005). For SME-Micros industry specific language used by regulators and professionals can prevent access to understanding this information (Crawford et al., 2013). This is a particularly worrying finding as SME-Micros tend to use this information as it is easy to access, freely available and from a trustworthy source. For Micros there are further concerns in terms of the use and flow of knowledge of information. Some OSH documentation, for example written policy statements, are not required for businesses with five or less staff. This raises a particular problem when investigating this subset of Micros as, having no need for a written policy statement, may translate into less formal business practices. Lansdown et al., (2007) recommend that sensitivity is considered in the classification and investigation of Micros.

There is clearly a difference between large (≥ 251 employees) and SME-Micro (≤ 250 employees) enterprises in terms of business structure, culture and available resources. However, findings from Crawford et al., (2013); Lansdown et al.,(2007) and emerging findings from an Institution of Occupational Safety and Health (IOSH) funded Knowledge Project, run by researchers at Loughborough University reveal interesting similarities in terms of the flow, translation and enactment of OSH knowledge for construction companies. For example, the amount of time spent implementing OSH and tailoring communication methods for specific audiences is important to the success of OSH knowledge retention. Moreover, regardless of size of the large enterprise size, face-to-face communication appears to be one of the most effective methods of getting work related information across to workers, with particular note given to the message conveyor. Trust in the source of information is seen as important, as is where people choose to access information. Respondents were also more likely to access information if it was freely available, for example from IOSH or the Health and Safety Executive (HSE). Intermediaries such as the National Health Service (NHS) and the HSE are seen as a crucial part of transferring OSH information

to SME-Micros so as to influence their engagement with OSH and effectiveness of any subsequent interventions (Walters, 2001). Hasle and Limborg (2006) highlight at this point of contact trust, experience and cost-effectiveness are important. Legg et al., (2009) also use external consultants, training agencies and industry associations as examples of intermediaries. The authors suggest that intermediaries are one of the most critical ways to engage with workers in SME-Micros. The ability of SME-Micros to develop contacts in this area is important as is the intermediary's ability to understand the unique workings of the SME-Micro. Barriers to transferring information were perceived to be; time constraints, workplace culture, literacy and language issues, lack of appropriate management and support, as well as the inability to get groups together due to shifts or geographical location. In construction debate has focussed on the presence and extent of trickle down of good practice and knowledge appropriation from large organisations to SMEs working as subcontractors to SMEs working alone to micros working alone. Brace et al, 2009 hypothesised that since the 1980s bad practice has gradually been replaced by good practice first in large companies then in medium companies working as subcontractors, then on their own and then to smaller companies, but with very little impact on micros. This view was also supported by Corr Willbourn (2009) where 'Ex Big Site Conformists' move to run small sites and apply good practices learnt elsewhere.

METHODOLOGY/COHORT

Study aims and objectives

Building on previous literature, a study was developed to meet the following objectives:

1. Investigate the perceptions of OSH among SMEs and Micros.
2. Consider barriers to access that may derive from the values and attitudes of Owner-Managers.
3. Define present sources of guidance.
4. Examine the relationship between sources of knowledge and guidance.
5. SME-Micro definition used in study as per European Communities Criteria for SME s and Micros.

Methodology

Eliciting data from the SME-Micro sector is a notoriously difficult and problematic process (Barrett et al., 2005; Landsdown et al., 2007; Crawford et al., 2013). Breakwell and Peets (2001) advise caution and careful planning when eliciting information from SMEs and low response rates to surveys and questionnaires have been cited throughout the literature (Storey, 1994; Breakwell and Peets, 2001). Effective stakeholder participation requires consideration of a) the power, reward and punishment capability of the contacting organisation, b) the complexity, embeddedness, and repetition of the communication, and c) the response requirements (awareness, compliance, behavioural change). Direct and personal approaches were shown to be more effective than general contact. This finding will be exploited; face-to-face and telephone interviews are the primary methods for data collection supported by an online version, presented as a questionnaire. The online questionnaire will follow the same objectives and augment the cohort. The interviews and online questionnaire (same inventory) have been designed to take 10 – 15minues to complete. Given the heterogeneous nature of SME-Micros, The European

Communities Criterion (headcount) for SME-Micros will be used to facilitate data collection and distinguish between SMEs and Micros. The researchers will work across several industries, with a specific focus on construction, logistics and healthcare. Data collected will be analysed to meet the aims and objectives listed above.

Data collection

Cohort

The eventual aim is to collect data from 230 participants across three industries; construction, healthcare, logistics as well as to other industries (see Table 2). Participants will be Owner-Managers of or working in SME-Micros (using the European Communities criterion for guidance,) as well as working inside and outside of larger established networks. Currently, data has been collected from 69 participants across from enterprises sized Medium, Small and Micro who work both inside and outside networks. Current data collection results across participating enterprises types can be seen in Table 3.

Table 2 Industry representation

Industry	(n)
Accommodation	2
Administration	0
Agriculture	20
Construction	10
Food	5
Healthcare	10
Hospitality	1
Logistics	1
Maintenance	1
Mining	5
Rail	7
Retail	3
Transport	1
Other	3

Table 3 Current data collection count

	Micro (n)	Small (n)	Medium (n)	Total (n)
In networks (n)	6	10	6	22
Not in networks (n)	43	3	1	47
Total (n)	49	13	7	69

RESULTS (EMERGING FINDINGS)

Practical use of the definition

The European Communities Criterion for SME-Micros definition is useful from a research perspective to categorise the cohort of participants when categorising the enterprises participating in this study. However, asking workers to recall headcount

can be difficult. Reasons for this include; seasonal variations in employee numbers and volunteers, different people making up the enterprise by including and excluding departments. In addition, some have self-employed people who work for them but are not viewed as employees, in terms of their responsibility for these people or for professional development and OSH, but are relied upon for the running of the enterprise. As such, this 'blurred' line of employee headcount can mean that enterprises categorise themselves differently to each other, or indeed how they stand in relation to the European Communities Criterion headcount.

In addition to the headcount being used to categorise the enterprises this does not account for industry variables. For example, in construction an enterprise with 200 – 250 direct employees would be considered large. It is common for companies in the construction industry work as subcontractors on large builds; however, these workers are not necessarily included in the headcount as they are not employed by the contractor even though, when onsite, the contractor has overall responsibility for the OSH of all workers, directly and indirectly employed.

Another issue with the definition is the use of the annual turnover and balance sheet total. Preliminary discussions with SME-Micro owners suggested this would be difficult to ascertain for several reasons, including; the turnover is sensitive in nature and some enterprises would not want to provide this information and the study could lose out on potential participants, the numbers are not known, or not known accurately, so would not be reliable and finally asking for this data would add additional time onto an interview that was being conducted in a short time frame. As such, it was decided that this question would not be used to categorise enterprises.

Factors influencing OSH knowledge engagement

Industry specific legislation - Workers described different factors influencing their OSH knowledge, including industry specific legislation. For example, people working with food were knowledgeable about food hygiene, reportedly through information provided by the Environment Agency however knowledge of how to be healthy and safe at work has been gathered through 'experience'. Participants, in authority of others who work for them; the 'Owner' and/or 'Managers', report understanding their position implies responsibility of OSH for their workers, however, this again appears to depend on what activities are being conducted. Much of this is based on experience and there is little detail given as to the specific information with regards to OSH legal requirements, unless this has been made clear to the participant through some external body; professional membership, including, amongst others, the HSE.

Enterprise size - The size of the enterprise and industry seem to affect how people view OSH. For Medium industries the use of consultancies for OSH appears 'common' however this is not the case for the Small and Micro enterprises. Industries, regardless of size, that are perceived to be high hazard; mining, rail, construction and for high hazard activities for example; working at height the serious risk to health and safety to workers and/or public is acknowledged. However the perceived lower risk activities; moving on-site/picking-up and carrying/dust exposure were not always discussed. That is not to say they are not seen relevant nor as issues to participants, but given the short duration of the interviews there is not enough time to gather in-depth data relating to all of these potential influences on workers OSH. As such it could be assumed that the activities that cause the most immediate risk to health are discussed. Based partly on data from other projects conducted at the University, in larger

enterprises there seems to be a more defined structure in terms of who provides, or is expected to provide OSH guidance and training, however, the sample is too small to draw conclusions regarding this at present.

Relevance of information

Participants were asked if the OSH information they had access to, was relevant to their job, some said that the information from legislation, professional or regulatory bodies such as the HSE was not relevant to their jobs or the way that they do their jobs. Participants noted that searching for guidance themselves improved the relevance of the information; search methods included using the internet or asking a colleague. The ability to search themselves appears, to users, as a reliable filter to remove unnecessary and irrelevant information whereas 'official information' can be, at times, redundant as there can be an abundance of information. This may, however be related to their ability to translate the information.

The role of the Owner-Manager

The role of the owner-manager is hard to define and, as such, interviews are being used to explore how enterprises are structured, this has shown that several of the participating enterprises have board members or more than one Owner-Manager. Currently the sample is too small to draw firm conclusions. The only time when it is clear who the Owner-Manager is, is when the enterprise is formed of one person who is self-employed or if there is only one Owner-Manager.

PRELIMINARY CONCLUSIONS

Caveat – These conclusions are drawn from preliminary data collection of a larger study. Where possible the paper has been written to address the aims and objectives as part of the larger study. These findings are generalised across all of the industries investigated, but are also relevant to construction.

The European Communities Criterion for SME-Micros offered a viable point to define cohorts for data collection. However, the heterogeneous nature of SME-Micros implies that the definition takes careful application in practice.

The literature suggests that Owner-Managers play an important role in OSH engagement. However, in practice SME-Micros may find it difficult to define Owner-Managers. This will be investigated further.

Available OSH information may not suit the working context of SME-Micro enterprises. Moreover, this information, especially legislation may be difficult for SME-Micro, specifically those with ≤ 5 employees, to interpret in line with their business needs.

SME-Micros are not 'mini larger' enterprises and so have different and unique OSH information needs.

A lack of capital and resources may limit the ability of SME-Micros to implement and maintain interventions.

REFERENCES

Antonsson, A.-B. (2007). Strategies for success? Managing chemical risks in small workplaces: A review of Swedish practice (Draft Research Report: B1717). Stockholm: Swedish Environmental Research Institute.

- Baldock, R., James, P., Smallbone, D., & Vickers, I. (2006). 'Influences on small-firm compliance-related behaviour: The case of workplace health and safety'. *Environment and Planning C: Government and Policy*, 24 (6), 827–846.
- Barrett, J. H., Haslam, R. A., Lee, K. G., & Ellis, M. J. (2005). Assessing attitudes and beliefs using the stages of change paradigm – case study of health and safety appraisal within a manufacturing company. *International Journal of Industrial Ergonomics*, 35, 871 - 887.
- Brace C., Gibb A. G. F., Pendlebury M., Bust P. D.(2009). Health and safety in the construction industry: underlying causes in construction fatal accidents – External research. Sudbury: HSEBooks, 2009.www.hse.gov.uk/construction/resources/phase2ext.pdf.
- Breakwell, G. M., & Petts, J. (2001). Stakeholder participation methods: scoping study (Contract Research Report No. 317/2001). Sudbury: Health and Safety Executive.
- Corr Willbourn (2009) Report of qualitative research amongst 'hard to reach' small construction site operators, HSE Research Report RR719.
- Crawford, J.O., Davis, A., Cowie, H., Ritchie, P., (2013) OSH Landscape Project. Using knowledge and information in occupational safety and health. Final report of an on-line survey of workers involved in OSH. Institute of Occupational Medicine Report.
- Eakin, J., Lamm, F., & Limborg, H.J. (2000). 'International perspective on the promotion of health and safety in small workplaces'. In K. Frick, P.L. Jensen, M. Quinlan & T. Wilthagen (Eds.), *Systematic occupational health and safety management: Perspectives on an international development*. Oxford: Pergamon.
- European Commission. Official Journal of the European Union (2003). Commission Recommendation of 6 May 2003 concerning the definition of micro, small and medium-sized enterprises. (notified under document number C(2003) 1422. (2003/361/EC)
- Garengo, P., Baize, F., & Biotitic, U. S. (2005). Performance Measurement Systems in SMEs: A review for a research agenda. *International Journal of Management Reviews*, 7(1), 25 -47.
- Great Britain Committee of Inquiry on Small Firms. (1971). *Small firms: Report of the Committee of Inquiry on Small Firms*. Chairman: J.E. Bolton. London: HMSO.
- Hasle, P., & Limborg, H.J. (2006). 'A review of the literature on preventive occupational health and safety activities in small enterprises'. *Industrial Health*, 44 (1), 6–12.
- Hasle, P., Limborg, H.J., Kallehave, T., Caroline Klitgaard, C., Andersen, T.R., (2012). The working environment in small firms: Responses from owner-managers. *International Small Business Journal* 2012 30: 622
- Hedal, L. (2002). *Små virksomheder og Internet - et markedsføringsperspektiv* (1st ed.). Odense: Denmark.
- Knuckey, S., Johnston, H., Campbell-Hunt, C., Carlaw, K., Corbett, L., & Massey, C. (2002). *Firm foundations: A study of business practices and performance in New Zealand*. Wellington, New Zealand: Ministry of Economic Development.
- Lansdown, T.C., Carolyn Deighan, C., Brotherton, C., (2007) Health and Safety in the Small to Medium -sized enterprise Psychosocial opportunities for intervention. Health and Safety Executive (HSE) Research Report RR578.

- Legg, S., Battisti, M., Harris, L-A., Laird, I., Lamm, F., Massey, C., Olsen, K., (2009). Occupational Health and Safety in Small Businesses. NOHSAC Technical Report 12
- Mayhew, C. (1997). Barriers to implementation of known occupational health and safety solutions in small businesses. Sydney: Division of Workplace Health and Safety and National Occupational Health and Safety Commission.
- McKinney, P. (2002). Expanding HSE's ability to communicate with small firms: A targeted approach (No. 420/2002). Sudbury, United Kingdom: HSE.
- Pedersen, B.H., Hannerz, H., Christensen, U., and Finn Tüchsen, F. Journal of Occupational Medicine and Toxicology 2011, 6:11
- Storey, D. J. (1994). Understanding the small business sector. London: Routledge.
- Toone, B. (2005). Protect your people -and your business. The practical one-stop health and safety toolkit. Wigston: IOSH.
- Wadick, P. (2007) Safety culture among subcontractors in the NSM housing industry. Journal of Occupational Health and Safety –Australia and New Zealand 23(2), 143-152.
- Walters, D. (2001). Health and safety in small enterprises -European strategies for managing improvement: P.I.E. Peter Lang.
- Wilkinson, A. (1999). 'Employment relations in SMEs'. Employee Relations, 21 (3), 206–217.
- Wrnieniewski, A. and Dutton, J.E. (2001), Crafting a job: reinvisioning employees as active crafters of their work, Academy of Management review, 26, 171-201

Technology and OHS

AN AGENT-BASED FRAMEWORK FOR MODELING CONSTRUCTION SAFETY RELATED BEHAVIORS

⁶⁸Zhongming Jiang, ¹Dongping Fang and ¹Tao Wang

*¹(Tsinghua-Gammon) Construction Safety Research Center, Department of Construction Management,
School of Civil Engineering, Tsinghua University, Beijing, 100084, China*

The pervasive unsafe behaviors of workers are the causes of accidents on construction sites, and meanwhile the safety related behaviors of management have an indirect but significant effect on the safety performance of workers. With inspiration from the complexity theory, the research regards construction accidents as an emergent consequence of behaviors and interactions among management and workers on construction sites. Agent-based modeling is a simulation-based technology aiming at analyzing a complex system by using virtual agents to imitate the behaviors and interactions of individuals in the system. A three-level agent-based framework for modeling construction safety related behaviors is proposed. On system level, the system structure, goal, information, resource and environment ought to be defined, and the approach of system dynamics is introduced to explore, summarize and depict the cause effect relationships among factors in a dynamic system consisting of management and workers; on agent interaction level, project manager, middle managers, safety professionals, supervisors are regarded as different types of management agents, and based on the safety responsibilities of each, the interactions among such managers and workers are discussed; on worker behavior level, a five-stage cognitive process for the analysis of workers' safety related behaviors is introduced, based on which worker behavior rules are established. The proposed agent-based modeling framework can stimulate simulation analyses on construction safety related behaviors, and the AnyLogic platform is suggested to perform the modeling. Through sensitivity analyses, control variables and scenario comparison in future research, the characteristics and patterns of construction safety related behaviors especially of unsafe behaviors can be revealed.

Keywords: agent-based, behavior, construction, safety, modeling.

INTRODUCTION

The construction industry has long been criticized for its poor safety performance. In the United States, 775 fatal injuries were reported from construction industry in 2012, a number substantially higher than other industries (US Bureau of Labor Statistics 2012). Although the construction industry in Britain accounts for 5% of the employees, it accounts for 27% of fatal injuries to employees and 10% of reported major injuries (UK Health and Safety Executive 2012). In China, the reported number of fatal injuries on construction sites reached 2437 in 2012, which exceeded that of the mining industry and became the most dangerous industry nationwide (China State Administration of Work Safety 2012).

⁶⁸ jzm10@mails.tsinghua.edu.cn

A construction project's complexity is often attributed to its characteristics such as large construction scale, numerous participants, and various interdependencies and interrelations (Jiang et al. 2008; Vidal and Marle 2008). Due to the complexity, traditional research methods in accident investigations and studies follow a linear process of "root-cause analysis", and ignore the effect of feedback and complex interactions between various factors of a system (Qureshi 2007), so the causations of construction accidents are still not well understood. Since failures are seen as an emergent property of complexity (Dekker et al. 2011), and construction workers' unsafe behaviors are often the immediate cause of accidents on construction sites (Haslam et al. 2005), with inspiration from the complexity theory, the research regards construction accidents as an emergent consequence of the behaviors and interactions on construction sites.

Simulation techniques are especially effective when the research problems are complex and contain uncertainty (AbouRizk 2010). Agent-based modeling tries to solve such complex problems by using agents' collaborative and autonomous properties (Park and Sugumaran 2005). This research proposes an agent-based framework for modeling construction safety related behaviors.

AGENT-BASED MODELING REVIEW

Ashworth and Carley (2007) compared 28 organizationally oriented simulation models, and found that agent-based models outnumbered other simulation types and were growing at a faster rate. Agent-based modeling is a simulation-based technology aiming at analyzing a complex social and economic system by using virtual agents to imitate the behaviors and interactions of individuals in the system (Twomey and Cadman 2002). An agent is generally used to denote an entity that possesses the following properties: (1) autonomy: agents control over their actions and internal states; (2) social ability: agents interact with other agents in a social context; (3) reactivity: agents can perceive and respond to the environment; (4) proactiveness: agents are to reach their own goals (Wooldridge and Jennings 1995). Agent's such capabilities make agent-based modeling more attractive than traditional simulation approaches.

A social-economic system manifests its complexity through the complexity of human behaviors, social structure, interactions and environmental context. In agent-based models, agents are especially able to show adaptive behaviors when in a complex adaptive system (Anderson 1999). Agent-based modeling is a "bottom-up" approach beginning from the depiction of the behaviors and features of the micro units which compose the whole system, and through the expression of such units' interdependent relationships and their evolutionary behaviors, reveals the emergent macro level operation mechanisms. Therefore, the emergent non-equilibrium, dynamical behavior of a system is usually one of the most interesting outputs of agent-based models (Twomey and Cadman 2002).

Park and Sugumaran (2005) introduced the architecture development processes for agent-based modeling. In the process of problem analysis, system boundary is set up and the goals of the system ought to be recognized; in the process of agent modeling, the classification of agents and their relationships are to be identified; and in the process of architecture development, the rules of agents' coordination and agent's autonomy are to be specified.

In the construction industry, agent-based modeling is utilized to study organizational problems (Min and Bjornsson 2008). Watkins et al. (2009) used the approach to represent the construction site as a system of complex interactions and study the relationships between congestion and labor efficiency. El-adaway and Kandil (2010) created a multi-agent system for construction dispute resolution, where solicitor, case librarian, case assistants, barristers, experts and judge were all developed as agents. Unsal and Taylor (2011) simulated the impact of the holdup problem in project networks.

FRAMEWORK FOR MODELING BEHAVIORS

A three-level agent-based framework for modeling construction safety related behaviors is shown in Figure 1.

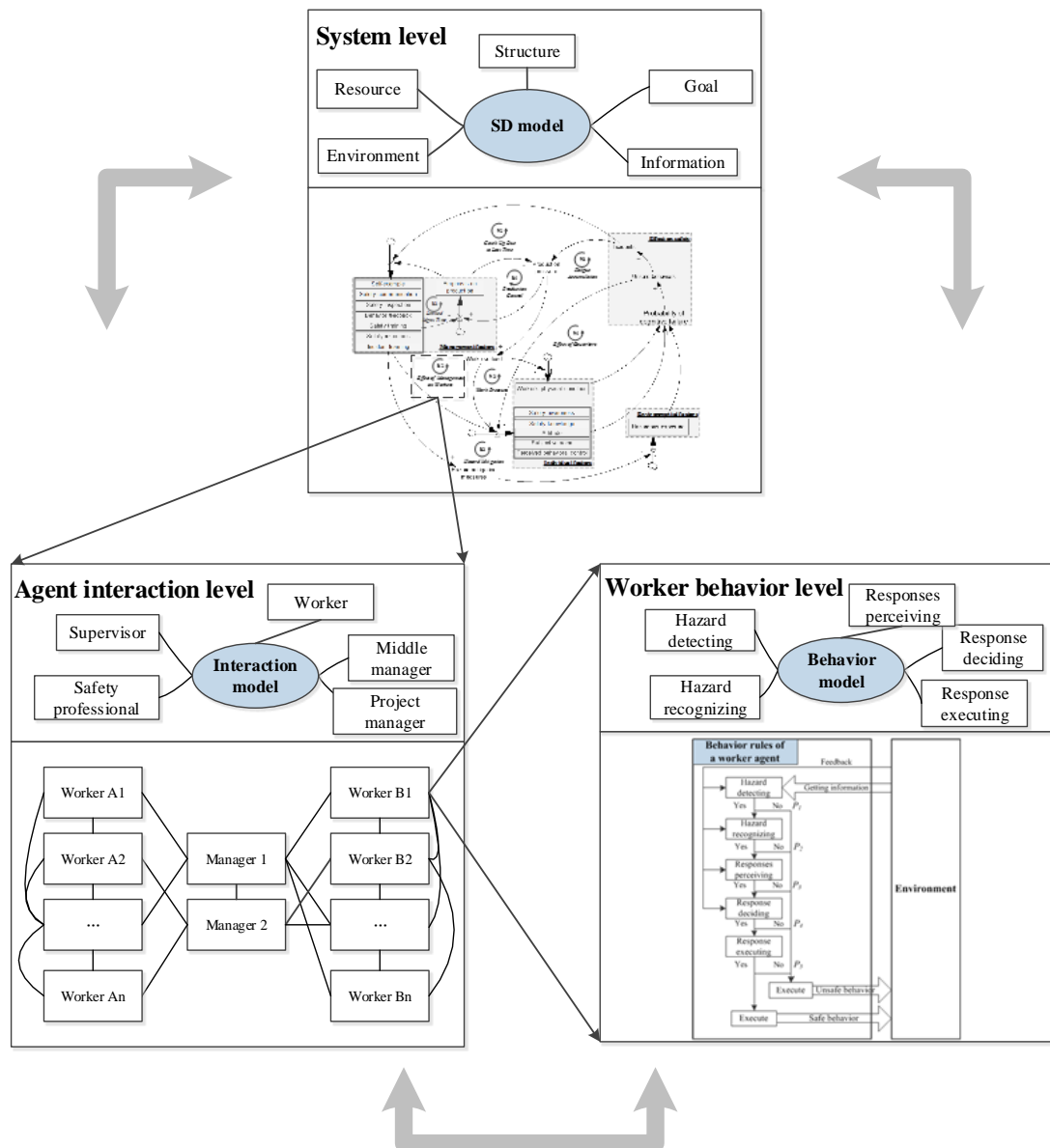

Figure 1: The agent-based framework

System level's main focus is in defining the overall properties of the project under study, which include system structure, system resource, system goal, system environment and system information; agent interaction level mainly focuses on the interaction among workers and managers, and in this research supervisors, safety professionals, middle managers and the project manager are regarded as different types of managers; worker behavior level defines the safety related behavior rules of each worker. The structure, resource, goal, environment and information of both agent interaction level and worker behavior level are obtained from the system level, and in return, the outcome of both levels provides feedback to the system level.

System level

The establishment of system level serves as a starting point for agent-based modeling. All agents behave and interact in certain social contexts. The organizational structure determines the way of task allocation, coordination and supervision. Besides, how many safety resources (e.g. budget, materials, etc.) are available on site? Is the site environment tidy and normalized? What are the major goals of the system? What are the endogenous factors that included in the system boundary and what are the exogenous factors out of the system boundary? Such problems should be solved on the system level.

The approach of System Dynamics (SD) is able to characterize the relationships among various factors. The dynamic variation of factors in the SD model can be regarded as the system variables for agent interaction modeling and worker behavior modeling. Based on targeted questionnaire investigation and project survey, the relationships in the causal loop diagram can be determined. Take a reinforcing loop "safety investment" for example. As shown in Figure 2, "safety investment" (SI) can enforce "safety education" (SE), purchase "safety facilities" (SF) and build "safety management system" (SMS), which together form the construction project's "safety competency" (SC). The enhancement of safety competency and the reduction of "number of accidents" (NA) can lower the "accident loss" (AL), and the saving cost can increase the project's "available fund" (AF), which further assures the safety investment. The definition equations are:

$$SI(t) = \int_0^t f_{AF}(AF(t))dt + SI_{t=0};$$

$$SE(t) = SI(t) * \alpha_{SE};$$

$$SF(t) = SI(t) * \alpha_{SF};$$

$$SMS(t) = SI(t) * \alpha_{SMS};$$

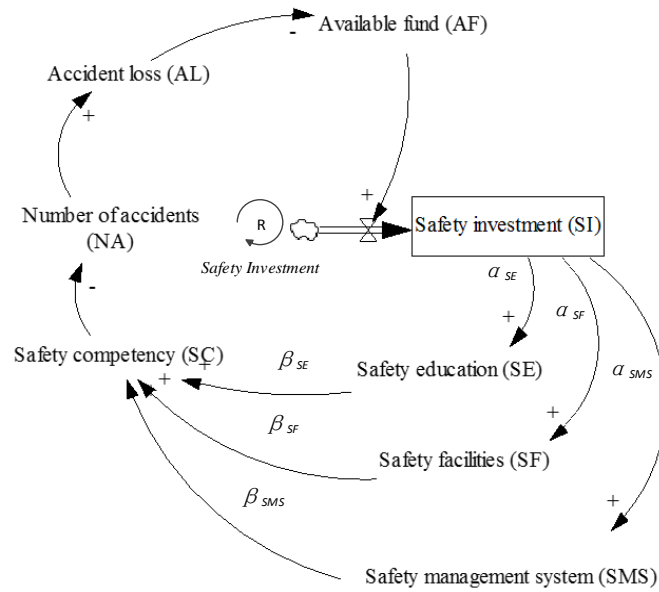

Figure 2: Reinforcing loop “safety investment”

$$SC(t) = f_{SE}(SE(t)) * \beta_{SE} + f_{SF}(SF(t)) * \beta_{SF} + f_{SMS}(SMS(t)) * \beta_{SMS};$$

$$NA(t) = f_{SC}(SC(t));$$

$$AL(t) = f_{NA}(NA(t));$$

$$AF(t) = f_{AL}(AL(t));$$

Here, X(t) is the value of variable X at time t, $f_X(X(t))$ is the specific function of X(t), α and β are model parameters.

Agent interaction level

The accomplishment of the project is the result of participants’ cooperation (Figure 3). In terms of safety management, managers exert important influence on workers by behaviors. If workers are informed when the site environment is changed, are encouraged when they are actively involved in the discussion on safety issues, or are corrected when their unsafe behaviors are observed, they would be more willing to conduct safe behaviors.

Different levels of management have different safety responsibilities, and have different effects on individual’s actions (Reason 1997). This research defines project manager, middle managers, safety professionals, supervisors as different types of agents, and describe the interactions between such managers and workers, based on the safety responsibilities of each discussed in the literature, as well as the regulations and rules from targeted site surveys on management practice.

As senior management, the project manager should focus on the cultivation of a successful safety culture (Ismail et al 2012). Whether the project manager’s safety commitment is visible to frontline workers, whether there are clear safety policies, procedures and effective communication of safety objectives, are among the project

manager's essential safety responsibilities. Wu et al. (2010) discussed three major roles for senior management: ensuring middle management's safety performance (accountability); ensuring the quality of safety management (quality control); and personally participating in safety activities (visibility).

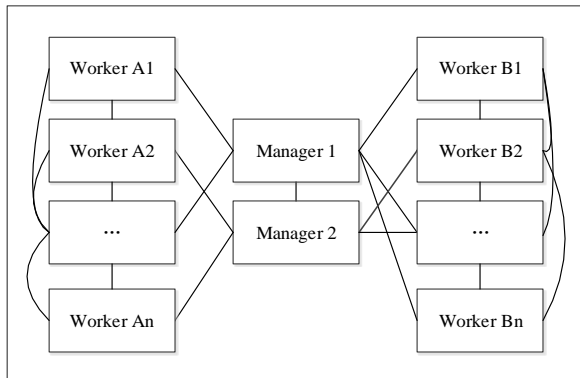

Figure 3: Interactions among managers and workers

Middle managers are the main implementers of the organization's safety policies. They should act as role models for workers, participate in safety meetings and other forms of communication, review and give feedback to workers' safety related behavior, perform safety monitoring, and participate in incidents investigation. They represent the department, and obey certain safety responsibilities. They are safety decision-makers, who are devoted to the implementation of safety procedures through work planning and resource allocation (Wu et al. 2010).

Safety professionals are the main executors of specific safety tasks. Virtually, upper management rely on their expertise for valid and reliable safety performance measurement (Wu et al. 2010). In order to fulfill their safety responsibilities, safety professionals must perform such duties: (1) keep records of safety related incidents; (2) make regular safety inspections to ensure safe working jobsite and behaviors; (3) keep up-to-date on safety regulations; (4) be involved in worker safety training; (5) keep regular communication on safety issues with superiors and subordinates; and (6) enforce incident investigations (Hinze 2006).

Supervisors are direct monitors to worker behaviors (Ismail et al. 2012). As the mediators between upper management and workers, supervisors play an important role in guiding workers' behaviors. Simard and Marchand (1994) found that participative supervisors were more effective in the improvement of safety performance. Since supervisors are direct superiors to frontline workers, and they have also the most frequent contact with workers, they are regarded as the key influential agents for workers. Typical safety roles of supervisors are (1) act as a good example towards safety; (2) make sure that workers receive adequate and appropriate equipment needed; (3) frequently communicate with workers on safety and check whether they obey safety rules; (4) give positive feedback to workers when they accomplish tasks safely; (5) give concern on workers; and (6) give serious consideration on the ideas offered by workers (Hinze 2006; Zohar and Luria 2005).

Worker behavior level

From the perspective of accident investigation, construction workers' unsafe behaviors are often the immediate causes of accidents. Zhang and Fang (2013) has introduced a five-stage cognitive process for the analysis of workers' safety related

behaviors. As Figure 4 shows, before a worker conducts a safe behavior, he or she gets information from the environment, and sequentially experiences: (1) detects a surrounding hazard; (2) realizes the possibility of injury due to the hazard; (3) retrieves memory or look at others to perceive safe responses; (4) selects the safe response; and (5) correctly executes the safe response. The cognitive failure in any of the above stages could result in unsafe behaviors. And the worker's attributes, such as safety awareness, safety knowledge, attitude, subjective norm, perceived behavioral control, physical condition, are the factors that could affect the cognitive processes.

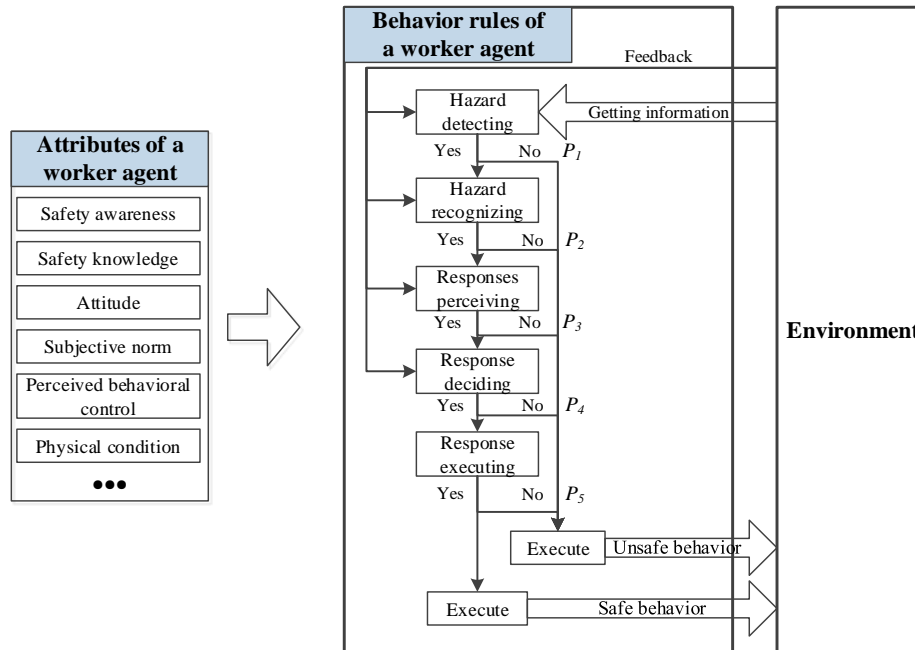

Figure 4: Worker behavior modeling

Suppose the factors affecting the cognition in stage i are $X_{i1}, X_{i2}, \dots, X_{in}$, thus whether a worker's cognition fails in this stage (dependent variable) and the relevant attributes of the worker (independent variable) can be obtained by questionnaire survey and in-depth interview, and based on linear regression, the coefficients $a_0, a_1, a_2, \dots, a_n$ for the estimation of the probability of cognitive failure in stage i (P_i) can be derived:

$$P_i = a_0 + a_1X_{i1} + a_2X_{i2} + \dots + a_nX_{in}$$

Thus, the probability of conducting an unsafe behavior by the worker is

$$P = P_1 + \sum_{j=2}^5 \prod_{i=1}^{j-1} (1 - P_i) * P_j$$

It is worth noticing that, the environment is affected by the constantly produced safe and unsafe behaviors throughout the project period, and in turn, such behaviors provide feedbacks to the later process of worker cognition.

DISCUSSION

Based on the agent-based model, simulation analyses on construction safety related behaviors can be realized. Through sensitivity analyses, control variables and scenario comparison, the characteristics and patterns of construction safety related behaviors especially of unsafe behaviors can be revealed. Researchers can regard the behavior related factors, including safety management behaviors (e.g. safety communication between managers and workers, safety investment) and workers' individual safety

related factors (e.g. educational level, safety awareness) as input parameters, and through the sensitivity analyses on such parameters, the characteristics of different types of construction safety related behaviors can be revealed. If one parameter's slight fluctuation can cause a major difference on the output, the parameter is a sensitive factor. Researchers can conduct computational experiments on the potential factors affecting behaviors, and find out the patterns upon which the factors exert influence on such behaviors. Researchers can conduct various simulation experiments under different scenarios and focus on the specific scenarios when undesirable results (i.e. relatively more unsafe behaviors) are achieved. Through variables comparison and analysis, a full picture of the influential factors can be obtained. The AnyLogic platform (<http://www.anylogic.com/>) is suggested to simulate the agent-based modeling, see Figure 5.

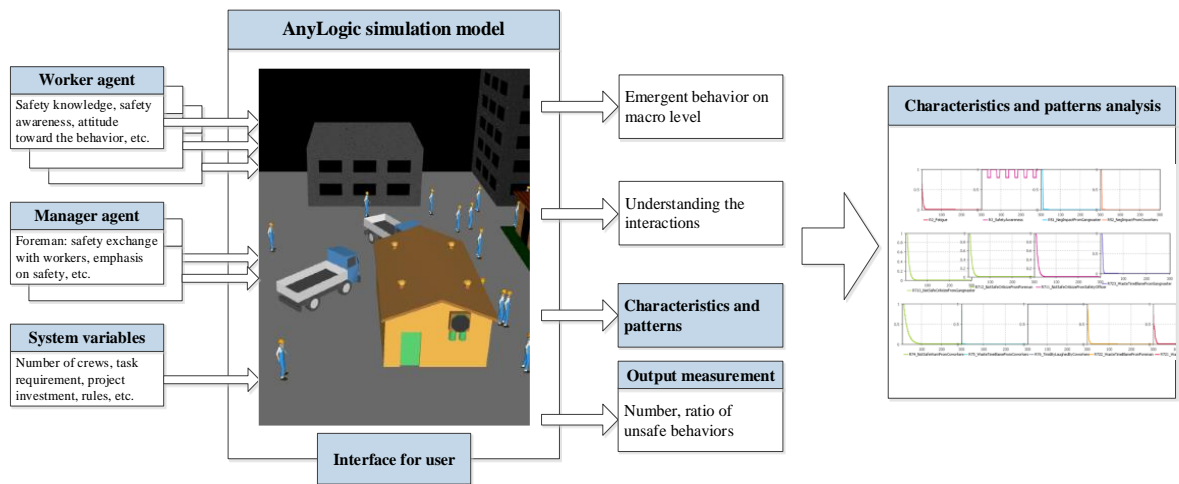

Figure 5: Simulation analysis through the agent-based model

CONCLUSION

This research proposes a three-level agent-based framework for modeling construction safety related behaviors. Analogous to the ANSYS software in structure engineering, the simulation model to be built can be used as an experiment platform for both fundamental research and practical use on construction safety related behaviors. Through amounts of computational experiment and observing the emergent behavior on the macro level, it is useful to examine the effectiveness of current practice, or unveil new phenomenon and patterns. A further application-oriented management tool can be developed upon specific demands. The process of constructing the simulation model, can further deepen the systematic analysis of unsafe behaviors and the understanding of the interactions among management and workers.

ACKNOWLEDGEMENT

This research was supported by Natural Science Foundation of China (Grant no. 51378296) and Specialized Research Fund for the Doctoral Program of Higher Education (Grant no. 20090002110044).

REFERENCES

- AbouRizk, S (2010) Role of simulation in construction engineering and management. "Journal of Construction Engineering & Management", 136(10), 1140-1153.

- Anderson, P (1999) Complexity theory and organization science. "Organization Science", 10(3), 216-232.
- Ashworth, M and Carley, K (2007) Can tools help unify organization theory? Perspectives on the state of computational modeling. "Computational & Mathematical Organization Theory", 13(1), 89-111.
- Chen, Y and Wang, B (2012) A study on modeling of human spatial behavior using multi-agent technique. "Expert Systems with Applications", 39(3), 3048-3060.
- China State Administration of Work Safety (2012) Available at: <http://www.chinasafety.gov.cn/newpage/kzzb/kzzb.htm>.
- Dekker, S, Cilliers, P and Hofmeyr, J (2011) The complexity of failure: Implications of complexity theory for safety investigations. "Safety Science", 49(6), 939-945.
- El-adaway, I and Kandil, A (2010) Multiagent system for construction dispute resolution (MAS-COR). "Journal of Construction Engineering and Management", 136(3), 303-315.
- Haslam, R A, Hide, S A, Gibb, A G F, Gyi, D E, Pavitt, T, Atkinson, S and Duff, A R (2005) Contributing factors in construction accidents. "Applied Ergonomics", 36(4), 401-415.
- Hinze, J (2006) "Construction safety". 2ed. Prentice-Hall, Englewood Cliffs, NJ.
- Ismail, F, Baharuddin, H, Hashim, A and Ismail, R (2012) Shared perceptions on safety practices among key personnel within construction companies. "Procedia - Social and Behavioral Sciences", 50, 361-368.
- Jiang, L, Qi, E and Du, B (2008) Study of the characteristics of large-scale construction projects with the viewpoint of complexity. Wireless Communications, Networking and Mobile Computing, "4th International Conference on IEEE", 2008.
- Min, J and Bjornsson, H (2008) Agent-based construction supply chain simulator (CS 2) for measuring the value of real-time information sharing in construction. "Journal of Management in Engineering", 24(4), 245-254.
- Park, S and Sugumaran, V (2005) Designing multi-agent systems: a framework and application. "Expert Systems with Applications", 28(2), 259-271.
- Qureshi, Z H (2007) A review of accident modeling approaches for complex socio-technical systems. Proceedings of the 12th Australian Conference on Safety-Related Programmable Systems, Adelaide, Australia, 2007.
- Reason, J (1997) "Managing the risks of organizational accidents". Ashgate Aldershot.
- Simard, M and Marchand, A (1994) The behaviour of first-line supervisors in accident prevention and effectiveness in occupational safety. "Safety Science", 17(3), 169-185.
- Twomey, P and Cadman, R (2002) Agent-based modelling of customer behaviour in the telecoms and media markets. "Info", 4(1), 56-63.
- UK Health and Safety Executive (2012) Work related injuries and ill health in construction. Available at: <http://www.hse.gov.uk/statistics/index.htm>.
- Unsal, H and Taylor, J (2011) Modeling interfirm dependency: game theoretic simulation to examine the holdup problem in project networks. "Journal of Construction Engineering and Management", 137(4), 284-293.
- US Bureau of Labor Statistics (2012) Fatal occupational injuries by industry and event or exposure. Available at: <http://www.bls.gov/home.htm>.

- Vidal, L and Marle, F (2008) Understanding project complexity: implications on project management. "Kybernetes", 37(8), 1094-1110.
- Watkins, M, Mukherjee, A, Onder, N and Mattila, K (2009) Using agent-based modeling to study construction labor productivity as an emergent property of individual and crew interactions. "Journal of Construction Engineering and Management", 135(7), 657-667.
- Wu, T, Lin, C and Shiau, S (2010) Predicting safety culture: The roles of employer, operations manager and safety professional. "Journal of Safety Research", 41(5), 423-431.
- Wooldridge, M and Jennings, N (1995) Intelligent agents: Theory and practice. "Knowledge Engineering Review", 10(2), 115-152.
- Zhang, M and Fang, D (2013) A cognitive analysis of why Chinese scaffolders do not use safety harnesses in construction. "Construction Management and Economics", 31(3), 207-222.
- Zohar, D and Luria, G (2005) A multilevel model of safety climate: cross-level relationships between organization and group-level climates. "Journal of Applied Psychology", 90(4), 616-628.

A CONSTRUCTION SAFETY EDUCATION SYSTEM BASED ON INTERACTIVE VIRTUAL REALITY

Akeem Pedro¹ and Chan Sik Park²

⁶⁹*Akeem Pedro 1 Department of Architectural Engineering, Chung-Ang University, Seoul, South Korea*

⁷⁰*Chan Sik Park 2 Department of Architectural Engineering, Chung-Ang University, Seoul, South Korea*

Construction accidents, injuries and fatalities have not declined significantly, despite arduous efforts of researchers, safety professionals and strongly enforced safety laws. Safety education is crucial in promoting safe and healthy construction work environments; however current pedagogical methods and tools at the university level are unable to provide students with hands-on practical experience. Studies have verified the strengths of virtual environments in facilitating hands-on learning in construction training and education. However, majority of these consider construction safety in isolation, whereas in reality, safety matters are intertwined with various activities, methods, machines and materials. This paper aims to address the problem by proposing a novel approach which integrates construction materials and methods with safety education. A prototype system is developed, using smart devices to connect to virtual construction site scenarios through textbook based QR codes. The system comprises of three sequential modules: (1) Safety and Hazard Lecture (SHL) phase which enhances traditional lecture materials with virtual jobsite scenarios; (2) Hazard Identification Game (HIG) phase which gives students an opportunity to practice identifying and responding to hazards in a virtual game environment; and (3) Student Evaluation (SE) phase which utilizes virtual scenarios in testing students safety knowledge and hazard identification abilities. The pedagogical suitability of the system is evaluated by a series of trials where the students interacted with instructors. Interim results indicate that the system offers an innovative medium for improving hazard identification ability, transferring safety knowledge and engaging students. Insights from applying virtual reality and matching safety with construction methods are also discussed in the paper.

Keywords: Construction Safety, Hazard recognition, Safety Education, Virtual Reality.

INTRODUCTION

Construction jobsites are among the most dangerous workplaces with fatalities and recurring accidents still plaguing the industry. These occur for various reasons; however one underlying causes relates to deficiencies in the education and training of construction project personnel (Guo et al, 2012). Effective safety training programmes have the potential to improve safety performance by preventing accident occurrence. Safety training also improves behavioral attitudes and makes accidents more predictable. Currently, at the industry level, typical safety training programmes are

⁶⁹ ianrepedro3@gmail.com

⁷⁰ cpark@cau.ac.za

delivered through on-site workshops. However, a large proportion of these have proven ineffective in sufficiently preparing workers and graduates for the work site. On the other hand, at the tertiary institution level, construction curricula vary in their approaches to safety education; with some programmes including safety topics in their curricula and others not. Furthermore, majority of the programs that do consider site safety matters tend to be passive, boring and not sufficiently motivating for students. As stated by Perdomo et al. (2005), the teaching tools in construction education are unable to sufficiently include complex details, realistic scenarios and construction problems that can enhance learning. This is further emphasized by Perry (2009) who states that a conundrum exists between construction principles taught in the classroom, and an applied understanding of what actually happens on construction jobsites. As a result, many graduates enter the construction industry with inadequate construction safety experience and knowledge. In attempts to improve tertiary education, Virtual Reality (VR) technologies have been applied and proved beneficial in various disciplines (Sampaio, Henriques et al. 2010). The medical, engineering and manufacturing disciplines have successfully used VR to create innovative learning environments which simulate realistic physical spaces (Reiner and Harders, 2012). Similarly, the construction industry has had its share of virtual reality systems with research efforts in construction worker training (Li. et al, 2012); (Xie et al, 2007) and site safety management (Park and Kim, 2012). Despite these studies, accident rates in construction remain high. Few studies have focused on the application of these technologies to safety education at the tertiary institution level.

Hence, this study aims to enhance construction education by adding site safety content to current curricula. It proposes a Virtual Safety Education System (VSES) which focuses on engraining safety knowledge into students during higher education. Through the use of VR, it aims to create immersive, captivating learning environments which will prepare students for the risks and hazards encountered on real construction sites. VR is adopted as a cognitive learning platform allowing learners to examine virtual site environments, identify hazards, and perceive the direct consequences of their actions virtually, without any detrimental real life consequences.

RELATED WORKS

The following section conducts a review of recent trends, research and developments in construction safety training and education, as well as the visualization technologies that have been adopted in the discipline.

Issues in Construction Safety Training and Education

Safety training and education have been proven to affect safety performance on construction jobsites. Through safety education and training, project personnel can become more aware and knowledgeable of potential construction site hazards and appropriate mitigation measures. Thus, effective safety education and training provide knowledge which helps reduce injuries and fatal accidents on construction jobsites. This safety knowledge is usually gained through safety toolbox meetings, specialized training programs, safety courses in universities, and through on-the job experience (Gambatese, 2004). Nowadays majority of safety training programs take place on construction jobsites, making use of educational presentations and videos which usually span over many hours. These training programs provide workers with detailed information about site risks and hazards, as well as safe behavior and practices. However, workers play a passive role in these programmes, hence finding them boring

and insufficiently engaging. In many cases, these programs are ineffective because they do not motivate trade workers and project personnel enough to learn about safety and health matters. Furthermore, training programs are usually delivered over relatively short periods of time, ranging from a day to a few days. Learning over such short time frames has limited potential to influence long term worker behavior. As noted by Lucas et al. (2008), knowledge acquired from typical training methods without reflection, experience and application may be quickly forgotten and the learning potential of the training lost. Safety training programs need to help project personnel develop efficient communication and full cognition of site safety and hazards (Topf, 2000). Without this, safety training is ineffective in improving site safety performance.

It is also essential that future construction managers, project managers and other project personnel involved in supervisory and managerial roles acquire an understanding of construction site safety. Even though they may not perform actual fieldwork, their safety knowledge and interactions with workers and other site personnel have a significant influence on jobsite safety (Gambatese, 2004). Tertiary safety education creates an opportunity to prepare future project personnel for the construction jobsite and it can be used to supplement on-site training. Some construction management curricula already include safety; however it is generally not considered a high priority (Jaeger, 2012). Most of the construction programs that include safety education have it as an individual course. However, in reality safety matters are often interwoven into other activities. Site safety is related to the construction methods, materials, and machinery being utilized on the project. Hence, ideally safety matters should be integrated with their corresponding subject areas.

A further limitation of construction education is limited student engagement and motivation. Moreover, due to the nature of construction work, safety training and education has to take place in hands-off off-site environments, where learners can only listen and watch without actively participating. Most construction safety courses use two-dimensional images and videos to represent site environments. However students cannot interact with video environments, hence they often play a passive role in their learning. To date, very few studies have taken advantage visualization technologies in order to improve construction safety education (Jaeger, 2012). Thus, there is currently a need to improve construction safety education by incorporating recent technological advances.

Visualization Technology and Mobile Devices in Construction Education

Computer technologies have significant impacts on student achievement, with benefits such as increased instructor-student interaction, cooperative learning, problem-solving and student inquiry skills (Behzadan and Kamat, 2011). Computer, information and visualization technologies have recently been advocated to provide support for construction safety education (Guo et al, 2012). Studies have shown the potential of game based learning in engaging and motivating students and reinforcing cognitive skills. As noted by Park (2012), educational games emphasize learning by doing, reflection and frequent feedback among students and teachers. Furthermore, students have been observed to show higher levels of concentration and grasp new concepts faster when exposed to 3D materials (Bamford, 2011). Nowadays countless games make use of immersive virtual environments allowing users to explore 3D interactive environments in real time (Sampaio et al, 2010). VR has been extensively utilized for

training professionals in high risk occupations such as pilots and nuclear power plant operators.

Several studies have considered VR as a tool to compliment traditional construction education. Perdomo et al. (2005) addressed the impact of 3D visualization and its advantages over traditional construction education approaches. Sampaio et al (2010) also explored the potential and applicability of VR, CAD and 3D modeling in architectural, engineering and construction education. Lin et al, (2011) conducted a pilot study of a walk-through based 3D game environment for construction safety education. These studies and others have confirmed that VR and serious games integrated into construction education processes can create authentic, meaningful tasks and activities. Furthermore, by providing engaging simulated environments, virtual reality and gaming can provide an opportunity to stimulate deeper learning among students. However, studies have not delved deeply into how gaming and virtual reality can be incorporated into existing construction safety course contents at higher education institutions. To date, most research focus on game development and applying virtual reality in isolation, without considering their actual practical applicability alongside other classroom activities.

Over the past few years, the advent of multimedia capable mobile technologies such as iPhones, iPads and PDAs has stimulated substantial interest in various industries. However broad perceptions of mobile technologies have remained centered on social communication, with limited consideration for mobile learning as a pedagogical activity in higher institutions. As stated by Fuertes, De Jong et al. (2008) mobile learning enables the application of theoretical knowledge learned in a practical scenario and reflection on the applied knowledge. Educators and developers have begun considering the implications of mobile devices on teaching and learning environments; however limited studies have done so for construction education. Mobile and smart devices can serve as powerful tools for educators in higher education, making information more accessible, delivery more efficient and personal (El-Hussein and Cronje 2010).

Against this backdrop, there is a noteworthy need for a construction safety education which would: (1) improve site environment perception and spatial cognition; (2) motivate and engage students; (3) Provide experience which resembles that on real construction sites. To address these needs, a construction safety education system which takes advantage of the aforementioned benefits of VR, Game Based Learning and smart devices is proposed.

VR-BASED CONSTRUCTION SAFETY EDUCATION SYSTEM

The following section describes the process adopted in developing a VSES prototype and the system features and functions incorporated to enhance construction safety and methods education.

VSES Framework

A 5 step process was adopted in developing the prototype safety education system. Initially, a literature review was carried out and interviews were conducted with students and educators from various countries in order to assess the state of construction safety education. Accident cases were analyzed, confirming the need for improved hazard identification capabilities in the construction industry. Based on these reviews and analyses, the required educational contents for the proposed system were identified. Subsequently, educational contents relevant to the Korean construction industry were

acquired through the Korean Occupational Safety and Health Agency (KOSHA) rules and regulations and KOSHA's Standard Risk Evaluation Model.

In order to develop virtual scenarios for the full VSES, several additional steps are required. As illustrated in figure 1, various contents will have to be matched. Firstly, accident cases, construction methods textbooks and KOSHA training documents will be analyzed. Based on the analysis, a suitable hazards classification will be determined for the VSES. Subsequently, safety rules, regulations, hazards and accident cases will be matched with textbook sections. Afterwards, the VSES virtual scenarios will be developed. The virtual scenarios will be stored in 3 web based databases, namely the 1) Lecture Scenario Database 2) Game Scenario Database and 3) Test/Exam Scenario Database. QR codes will be generated and embedded in their respective locations for each virtual scenario.

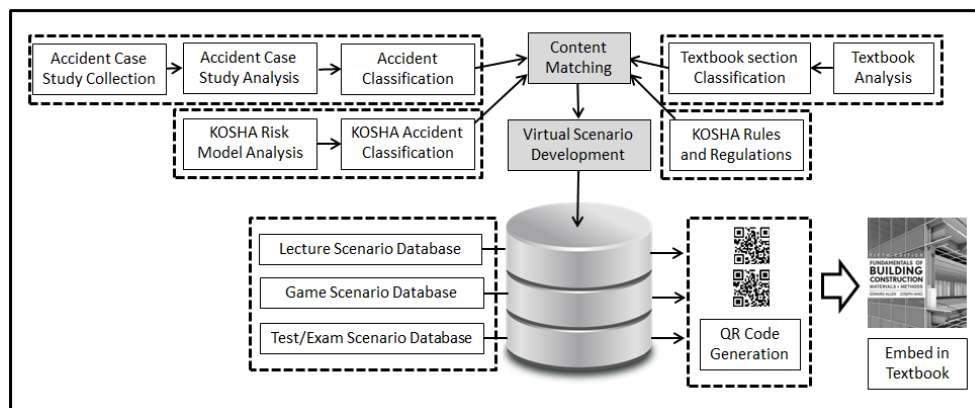

Figure 1: Virtual Scenario Development Process for Full VSES

VSES Modules

A system comprising of three modules is proposed, namely: (1) the Safety and Hazard Lecture (SHL) module; (2) Hazard Identification Game (HIG) module; and (3) Student Evaluation (SE) module. Each module is described as follows:

Safety and Hazard Lecture (SHL) Module

The purpose of the SHL phase is to introduce the safety topic, e.g. hazards related to concrete work. Students point their smart devices at the QR codes in their textbooks in order to access virtual scenarios. These allow learners to clearly visualize the type of jobsite environment being considered. Principles and approaches to safety and hazard mitigation are taught. Relevant safety rules and regulations are considered and conventional materials are supplemented with VR scenarios. These visualizations show ideal work methods based on KOSHA training documents and accident cases. With an educator's guidance, learners discuss conditions that are pre-cursors to accidents in example cases. To conclude the phase, students participate in group discussions and reflect on the safety and hazard topics covered. Lastly, students are given an opportunity to ask the lecturer questions about what they have learnt. After the lecture, students should be aware and knowledgeable of hazards associated with the types of construction work under consideration.

Hazard Identification Game (HIG) Module

The HIG is designed to give students an experiential opportunity to practice identifying and responding to hazards on construction sites. The development of these skills is

crucial because site safety performance is dependent on construction personnel and their ability to identify and respond to hazards. Learners use their smart devices to connect to a virtual construction site scenario comprises of two core activities: (1) Hazard identification activity and (2) Hazard response activity. For the first activity students are instructed to work in teams and explore the virtual site and recognize all the hazards before any accidents occur. If students do not identify the hazards on time, accidents occur in the virtual scenario. With the touch screen functions of tablet and smart devices, students can virtually explore and move through site environments, and click on various virtual elements such as workers, materials, machinery and work areas. After a scenario component is clicked, a list is displayed and students click the option that best describes the hazard in the scenario being viewed. The game is successfully completed when all the hazards are identified on time, and no accidents occur. Next, learners are required to describe how they would respond to the observed hazards. Students are encouraged to communicate clearly and describe what actions are necessary to prevent accidents and injuries. Lastly, the lecturer checks and confirms the students' answers and responses for both activities. Furthermore, feedback is given regarding students' performance in the game. Students also have an opportunity to ask questions and clarify any uncertainties and issues encountered.

Student Evaluation (SE) Module

The student evaluation phase is designed to ensure that construction students have the ability to apply their safety knowledge to realistic site scenarios. Learners are evaluated with a novel approach using VR based tests, exams and assignments, whereby students can view 3D simulations of construction site processes. Three types of questions are proposed for this phase: 1) Multiple Choice Questions (MCQs): Include written questions just like traditional tests and exams, however potential answers are provided using QR codes rather than written text. 2) Site Management Scenario Questions: These questions are more detailed than the aforementioned MCQs. Students are required to inspect a complex building site with numerous activities taking place simultaneously. A picture of the entire building site is provided, enhanced with QR codes, which link to detailed virtual scenarios of specific areas on the site. Students are required to identify hazards, describe their nature and mitigation strategies. 3) Job Safety Analysis (JSA) Review Questions: Students are required to view a virtual site environment and compare it to its corresponding JSA document and assess whether all the hazards and risk have been correctly defined and appropriately considered.

VSES PROTOTYPE DEVELOPMENT

Virtual Content Development

The prototype VSES involved the deployment of a virtual environment and animation for the SHL phase; and a virtual game scenario for the HIG phase. Majority of the virtual contents were developed using “Blender”, a free and open-source computer graphics software product with features including 3D modeling, UV unwrapping, texturing, rigging, animation and a built in game engine. The study implemented this software primarily because it is fast, relatively easy to use, and has a diverse range of features comparable to mid-high range commercial and proprietary software. The prototype development process began with modeling a building under construction and a surrounding site and background (Figure 2).



Figure 2: Model of construction site and background

Virtual Scenario Development

Concrete Works Scenario

In evaluating the SHL phase, two virtual scenarios focusing on concrete work were developed. Concrete work was chosen since it is one of the most commonly used building materials, playing an indispensable role in modern building, design and construction. Through smart devices, learners accessed virtual animations portraying laborers pouring cement for columns. As illustrated in figure 3, one animation depicts work without the required Personal Protective Equipment (PPE); while the second illustrates the ideal situation with appropriate PPE. The focal point of these visualizations is teaching students about common hazards and the importance of protective wear in conjunction with the relevant concrete construction methods.



Figure 3: Animations illustrating workers with and without PPE

Temporary Works Scenario

The HIG is designed to comprise of several virtual scenarios, with each one focusing on a specific area of a virtual site. The scenarios depict various situations giving students an opportunity to practice applying their knowledge of hazard identification. In order to evaluate the HIG phase, a virtual scenario involving temporary works was developed. Temporary works were chosen since many accidents involve work on temporary structures such as formwork, temporary bridges, etc. The site scenario displays two workers carrying a formwork panel away from a cured concrete column. Along the laborers walk path, there is a partially protected opening, an electric cable and bricks lying around. Students are required to explore the virtual environment, identify all the hazards, click on the relevant elements, and select the right hazard description before an accident occurs.



Figure 4: Visualizing Consequences of actions in HIG

If hazards are correctly identified no accidents occur, whereas if hazards are incorrectly or incompletely identified, an accident occurs on the virtual site (figure 4). Through this, learners can perceive the outcomes of their actions. Subsequently learners explain the hazards and appropriate elimination and mitigation strategies (type of guardrails, barriers and fall protection required to make the work area safe). Figure 5 (left) depicts a learner participating in the HIG after connecting through a worksheet QR code. The image on the right portrays the student clicking on options that pop up after he clicks a virtual site component. A green tick mark appears next to options that have been selected on the game interface.



Figure 5: Connecting to the HIG through QR codes and clicking options

EVALUATION

System Evaluation

A team from the Construction Technology Innovation Laboratory carried out a preliminary evaluation of the VSES with a group of 10 learners from the Chung Ang University School of Architectural Engineering in South Korea. The evaluation participants were given a brief introduction and some background information on the study. The volunteering students used “Qrafter” freeware on an Apple iPad Mini to connect to the SHL animations and participate in the HIG scenario. After this, the students provided feedback on their learning experiences. Discussions were also held with a few professors, and some feedback and recommendations were received. The entire evaluation process took around 10 minutes per learner, and through a 5 point Likert scale satisfaction survey, the systems effectiveness was assessed in terms of its potential to integrate safety with construction methods education, transfer safety knowledge, and improve hazard identification ability and accessibility to safety information. Other evaluation criteria considered the systems potential in facilitating active learning, outcome perception, virtual environment interaction and engaging and

motivating learners. Students were also encouraged to provide any additional comments, recommendations and feedback.

Results

As portrayed in table 1, the VSES satisfied all its effectiveness criteria. Learners and educators recognized the systems potential especially in improving hazard identification ability and improving accessibility of safety information. Furthermore, it was found effective in supporting active learning, motivating and engaging students. The two lowest scoring criteria were “interaction with virtual environment”, and “integrating safety with construction methods”. Possible reasons for these lower scores are provided in the discussion and conclusion.

Table 1: VSES evaluation results

Effectiveness Criteria				Other Criteria				
Improving Hazard Identification ability	Transferring Safety Knowledge	Integrating Safety with Construction Methods	Improving accessibility to safety information	Active learning	Captivation and engagement	Motivation	Outcome Perception	Interaction with virtual environment
4.32	3.9	3.5	4.5	4.3	4	4.3	3.9	3.5

Even though preliminary results are promising, a noteworthy amount of further work is required in the evaluation of the system. A performance based comparison will be implemented, assessing learner’s safety test scores prior to traditional safety education and the proposed virtual safety education. Differences between the before and after education scores will be calculated, and the significance of the differences will be validated through T-tests. Immediate and 6 month safety knowledge retention levels will also be evaluated.

DISCUSSION AND CONCLUSION

This study developed a prototype safety education system for university students, utilizing virtual reality and smart devices to enable access to virtual site scenarios through textbook based QR codes. The system comprises of three phases: (1) Safety and Hazard Lecture (SHL), (2) Hazard Identification Game (HIG), and (3) Student Evaluation (SE). Feedback from system trials and interviews suggests the VSES would improve hazard identification ability, improve accessibility to safety information and support the transfer of safety knowledge. However, a few participants considered the approach only slightly effective in integrating safety with Construction methods. This could be due to the small number of prototype scenarios, which limited learner’s perceptions of the whole envisaged system. Also, interaction with the virtual environment was considered somewhat neutral in the prototype game. This was due to limitations in time for the development of a fully functional multi-scenario game. The next stages of the VSES development will involve matching safety rules, hazards and accident cases with textbook sections. The HIG will be developed with full interactivity and functionality and additional case studies and hands-on system trials will be conducted in order to further explore and confirm the system applicability, and provide assurance of its pedagogical benefits. In conclusion, the authors believe that VR and smart devices would bring immense benefits to construction education at the university

level. This study has shed light on how VR can enhance and facilitate the integration of construction methods and safety education.

REFERENCES

- Bamford, A. (2012) The 3D in Education White Paper.
- Behzadan, A.H. and V.R. Kamat. (2011) Integrated information modeling and visual simulation of engineering operations using dynamic augmented reality scene graphs. *Journal of Information Technology in Construction*
- Dickinson, J. K., Woodard, P., Canas, R., Ahamed, S., & Lockston, D. (2011). *Journal of Information Technology in Construction*. 16: p. 119-133.
- El-Hussein, M.O.M. and Cronje, J.C. (2010). Defining Mobile Learning in the Higher Education Landscape. *Educational Technology & Society*,. 13(3): p. 12-21
- Fuertes, A., De Jong, T., Specht, M., & Casals, M. (2008). Mobile learning in a Real-World Construction Engineering Scenario.
- Gambatese, J.A. (2003) Safety emphasis in university engineering and construction programs. *Construction safety education and training. A global perspective*.
- Guo, H., Li, H., Chan, G., Skitmore, M. (2012) Using game technologies to improve the safety of construction plant operations. *Journal of Accident Analysis and Prevention*. 48: p. 204-213.
- Jaeger, M. and Adair D. (2012) Construction Safety Simulations and Students' Perception of Stress. *Engineering Education*. 23: p. 26.
- Le, Q.T., and Park, C.S.(2012). Construction safety education model based on second life. *Teaching, Assessment and Learning for Engineering (TALE), IEEE International Conference*.
- Li, H., G. Chan, and M. Skitmore (2012) Visualizing safety assessment by integrating the use of game technology. *Automation in Construction*. 22: p. 498-505.
- Lin, K.Y., Son, J.W., and Rojas, E.M. (2011) A pilot study of a 3D game environment for construction safety education. *Journal of Information Technology in Construction*. 16: p. 69-83.
- Lucas, J., Thabet, W., and Worlikar, P. (2008) A VR-based training program for conveyor belt safety. *Journal of Information Technology in Construction*. p. 381-407.
- Park, C.S., and Kim, H.J. (2013) A framework for construction safety management and visualization system. *Automation in Construction*. 33(0): p. 95-103.
- Perdomo, J.L., Shiratuddin, M.F., Thabet, W., Ananth, A. (2005) Interactive 3D visualization as a tool for construction education. *Information Technology Based Higher Education and Training. ITHET 2005. 6th International Conference*.
- Perry, F. (2009) The Construction Game-Using Physical Model Making to Simulate Realism in Construction Education.
- Sampaio, A. Z., Ferreira, M. M., Rosário, D. P., & Martins, O. P. (2010). 3D and VR models in Civil Engineering education: Construction, rehabilitation and maintenance. *Automation in Construction*, 19(7), 819-828
- Sampaio, A., Henriques, P., and Martins, O. (2010) Virtual Reality technology used in civil engineering education. *Open Virtual Reality Journal*. 2: p. 18-25.

- Shiratuddin, M.F. and Fletcher, D. (2007) Utilizing 3d games development tool for architectural design in a virtual environment. 7th International Conference on Construction Applications of Virtual Reality
- Topf, M.D. (2000) A look at demographic and social challenges facing the new breed and the old guard of safety professionals. *Occupational Hazards*,. 62(11): p. 49-52..
- Vinodkumar, M. and M. Bhasi. (2009) Safety climate factors and its relationship with accidents and personal attributes in the chemical industry. *Safety Science*. 47(5): p. 659-667.
- Xie, H., Tudoreanu, E., and Shi, W. (2006) Development of a Virtual Reality Safety-Training System for Construction Workers. *Digital library of construction informatics and information technology in civil engineering and construction*, 2006.

SKILL DECAY OF WIND TURBINE TECHNICIANS IN THE USE OF RESCUE AND EVACUATION DEVICE DURING EMERGENCY

Billy Hare¹, Kenneth Lawani² and Iain Cameron³

¹*Billy Hare 1 School of Engineering & Built Environment Glasgow Caledonian University
Cowcaddens Road Glasgow UK G4 0BA*

²*Kenneth Lawani 2 School of Engineering & Built Environment Glasgow Caledonian University
Cowcaddens Road Glasgow UK G4 0BA*

³*Iain Cameron 3 School of Engineering & Built Environment Glasgow Caledonian University
Cowcaddens Road Glasgow UK G4 0BA*

The management of wind farms consists of the operation, maintenance and administration of structures either onshore or offshore. Therefore, management must take into account the competency of the technicians since they are the initial responders in times of emergency rescue and evacuation. The aim of this paper is to explore and establish the occupational health and safety challenges in the wind energy industry in relation to wind technicians' skill decay in the use of a rescue and evacuation device during an emergency. The study reported here evaluated the effectiveness of the retention interval set by the training standards, the impacts of training on refresher and fresher trainees and their rates of 'forgetting' over a three-month period. Thirty trainees participated in the study with assessments at one and three-month intervals. While the performance level of all the participants improved during acquisition, there was observed decline in the performance level of the refresher and fresher trainees over a period of 28 and 90 days. In accessing the relative costs and benefits of sustaining procedural skills, it is considered that extra training will enhance retention regardless of whether it is during initial training or conducted as a refresher course afterwards. It is recommended that fresher trainees receive earlier refresher training to improve their proficiency. Although this project is on-going, these initial findings seem to be in conformity with previous skill decay research.

Keywords: acquisition, emergency rescue, retention, skill decay, wind technicians.

INTRODUCTION

The management of wind farms consists of the operation, maintenance and administration of structures either onshore or offshore. Within the last few years, the development and ownership of wind farms has experienced a global trend towards public utilities and independent power producers (IPP). Factors which have contributed to growth in the wind energy sector include financial confidence, innovation in technology, public and self-awareness, and legislative support from the local governments, (EU-OSHA, 2013). Planned and efficient wind farm management strategies can maximise both energy generation and operational performance and

⁷¹ B.Hare@gcu.ac.uk

financial output of wind farms. With the growth of the wind energy, new dimensions of challenges will begin to emerge. As the number of technicians employed in the industry continues to increase, issues of occupational health and safety will become an integral part of the work life cycle. The introduction of new innovations in the industry in terms of working processes will also trigger new hazards which will require a combination of appropriate skills to deal with them, (EU-OSHA, 2013). The management of wind farms must therefore take into account the competency of those working on the structures in the same way other industries do.

There is a regulatory requirement that operational wind farm have a secured and effective emergency response to incidents/accidents affecting persons on an onshore/offshore wind farm installation or engaged in activities in connection with it, and which have the potential to require evacuation, escape and rescue, e.g., Management of Health and Safety at Work Regulations 1999, (Reg. 8); Maritime and Coastguard Agency (MGN 371)- Offshore Renewable Energy Installations (OREIs) - Guidance on UK Navigational Practice, Safety and Emergency Response Issues – Annex 5; MCA – Offshore Renewable Energy Installations, Emergency Response Co-operation (ERCoP) for Construction and Operations Phase, and Requirements for Emergency Response and SAR Helicopter Operations; Search and Rescue (SAR) Framework Document for the United Kingdom of Great Britain and Northern Ireland; (Health and Safety Executive, 1997) etc. Currently, there is no strategic amalgamation of emergency response units within the UK wind industry. Therefore, the initial response in times of emergency rescue and evacuation will have to come from the technicians themselves. Such skills make up part of the basic training the technicians receive.

The GWO, (Global Wind Organisation Standard, 2013) has been involved in developing a common training standard for the wind energy sector. This has resulted in the development of a standard for basic safety training which covers areas such as first aid, manual handling, working at heights, fire awareness and offshore sea survival⁷². Within the UK, (RenewableUK, 2014), in consultation with members and key industry stakeholders, have developed industry training standards, such as working at height and rescue and marine safety training at national level in order to enhance the basic skills and knowledge of anyone working in the wind energy sector. These training standards by RUK have otherwise been formulated to make it compatible with that of GWO standards⁷³.

The aim of this paper is to explore and establish the occupational health and safety challenges in the wind energy industry in relation to wind technicians' skill decay in the use of a rescue and evacuation device during an emergency situation.

The hypothesis of the research reported in this paper is that after the initial training/acquisition received by wind technicians and due to the infrequent nature of practically carrying out on-the-job rescue and evacuation roles, there is a likelihood of skill and knowledge decay in times of significant emergencies except where there is a support system available to the technicians. One of the objectives of the research is to investigate and quantitatively demonstrate if wind turbine technicians are capable of retaining knowledge and skills learned within a 24 month period, being the current

⁷² <http://www.ewea.org/policy-issues/health-and-safety/gwo-standards/>

⁷³ <http://www.renewableuk.com/en/our-work/health-and-safety/training/index.cfm>.

validity period before they undergo any retraining/refresher sessions and if cued recognition/recall test can impact on their rate of retention.

The significance of a wind farm technician to be trained, competent and respond to initial onshore/offshore rescue emergency situations cannot be overemphasised. Wind technicians are exposed to hazards and risks and as such it is expected that they be trained in safety and emergency procedures above the basic competency level which is set out by the regulating bodies. The basic competency level encompasses Health & Safety training for any employee undertaking a defined role or task on any wind project, and covers all life cycle phases, (RenewableUK, 2014). The scope and application primarily take into account the specific risks that the individual is exposed to in addition to any company or project requirements. The main legislation relevant to Health & Safety training covered by these guidelines includes but not limited to the following: Health & Safety at Work etc. Act 1974, Confined Spaces Regulations 1997, Construction (Design and Management) Regulations 2007, Electricity at Work Regulations 1989, Regulatory Reform (Fire Safety) Order 2005, Health & Safety (First Aid) Regulations 1981 (as amended), Lifting Operations and Lifting Equipment Regulations 1998 (LOLER), Management of Health & Safety at Work Regulations 1999, Manual Handling Operations Regulations 1992 (as amended), Work at Height Regulations 2005, Provision and Use of Work Equipment Regulations 1998 and Control of Substances Hazardous to Health Regulations 2002. It is therefore the legal requirement of employers to ensure that suitable information, instruction and training is provided to employees and others who may be exposed to risk, (RenewableUK, 2014). The Management of Health & Safety at Work Regulations 1999 clarify an employer's responsibility for ensuring employees are provided with adequate health & safety training and are deemed competent to perform the work they are required to carry out. In any situation whereby employees are exposed to new or increased risks, training must be recurrent periodically to take account of any new or changed risks to the health & safety of the employees concerned. Much of Britain's health and safety law originated in Europe and proposals from the European Commission may be agreed by member states that are responsible for making them as part of their domestic law, (Health and Safety Executive, 2003). To fulfil the requirements of the legislation, suitable and sufficient risk assessments and training-needs analysis (TNA) should be conducted and this involves the employer assessing training needs, prioritising training, delivering the training effectively and reviewing and assessing the effectiveness of such training.

There are no mandatory training schemes or standards that specifically apply to large wind projects in the UK, (RenewableUK, 2014). However, standards and schemes that have been developed and supported through industry consensus (e.g. RenewableUK standards) are likely to be regarded as a 'benchmark of good practice'⁷⁴. Within the wind industry, benchmark standards have been developed by the industry to address significant risks specific or particular to the wind sector and these are supported by suitable third party accreditation systems like RenewableUK Training Standards and Global Wind Organisation – Basic Safety Training. There are some fundamental principles of occupational safety and health which are adopted by the ILO such as the Occupational Safety and Health Convention, 1981(No. 155) and its Protocol of 2002 which identifies the need for the adoption of a coherent national occupational health and safety policy, the Safety and Health in Construction Convention, 1988 (No. 167)

⁷⁴ <http://www.hse.gov.uk/risk/theory/alarp2.htm>

which provides for detailed technical preventive and protective measures which are requirements related to safety of workplaces, machines and equipment used and work at height⁷⁵.

This research explores the “skill decay” of wind turbine technicians in procedural use of a standard rescue and evacuation device, (type RG9A, see Fig. 1). A wind turbine safety, rescue and evacuation training program is a critical component of efforts to improve the reliability of technicians because skill decay in this area can lead to underperformance in times of rescue and increased likelihood of further accidents. Though past research has highlighted the significance of refresher training, there has been some debate concerning the appropriate content and frequency of such training, (Teachout, et al., 1993).

The concept of skill theory focuses primarily on cognition and intelligence as it deals with aspects of learning and problem solving. According to (Fischer, 1980), this concept deals with several key issues: the relation between organism and environment in cognitive development and the issues of sequence and synchrony. Fischer (1980) also stated that skills develop step by step through a series of 10 hierarchical levels divided into three tiers. These tiers specify skills of vastly different types: sensory-motor skills, representational skills, and abstract skills. Skill theory, therefore, provides a mechanism for predicting and explaining the development of skills in specific task domains, and it also gives a general portrait of how populations of skills change with development. This skill theory concept may be applicable to areas as diverse as language development, social development, and learning. According to (Watson & Fischer, 1977), skill theory should be able to predict the development of memory skills, and it has already been used as a tool for uncovering some new memory phenomena, such as a relation between recall success and skill level. Skill is different from competence, ability, or capacity, skill is a concept that is context-based and task-specific, (Fischer & Yan, 2002). It is a unit of behaviour composed of one or more sets. Behavioural research has shown repeatedly that task factors have potent effects on most kinds of behaviour in people. The Health and Safety Executive (1999) guide highlights that people can cause or contribute to accidents or mitigate the consequences in a number of ways. Through a failure a person can directly cause an accident but however, people tend not to make errors deliberately. Such failures do occur by the way our brain processes information, by our training, through the design of equipment and procedures and even through the culture of the organisation we work for. With regards to organisation, the concept of organisational accident and the Swiss cheese model (Reason, 1990) is an accepted theory which influences safety science thinking. Designing tasks, equipment and workstations to suit the user can reduce human error, accidents and ill health and failure to observe ergonomic principles can have serious consequences for individuals and for the whole organisation.

Skill decay is the progressive deterioration of knowledge when they are not put into use over extended periods of time. As more time elapses, there comes more decay (Arthur Jr., et al., 1998, Arthur, et al., 2007). According to Tarr (1986) in (Kim, et al., 2007), surveys have shown that personnel in technical jobs perform mostly procedural tasks. Procedural tasks are those that involve a number of coherent steps that may

⁷⁵ <http://ilo.org/global/standards/subjects-covered-by-international-labour-standards/occupational-safety-and-health/lang--en/index.htm>

include any combination of cognitive and motor skills. Konoske & Ellis (1991) noted that many procedural tasks can be viewed as an ordered sequence of steps or operations which are performed on a single object or in a specific situation to accomplish a goal. Reports by (Hurlock & Montague, 1982) showed better retention of continuous tasks. They stated that tasks with a meaningful organisation or coherence of steps tend to be remembered better. A well-organised task may include cues for the next step, allowing for recognition of the next step. Shields et al, (1979) found that soldiers tended to forget the steps in a procedure that were not cued by the previous step, for example, forgetting safety steps not intrinsic to the process. Consequently, the objective in relation to emergency rescue was to study skill decay (retention) using cued recognition and recall processes and observe the skill decay path and impacts on the research participants. Retention, which is the outcome of successful learning, seems to be a straightforward concept, one that is typically measured by having the learner recognize, recall, repeat or reproduce what they have acquired. Retention of a subject matter can be assessed both directly and indirectly, by employing recognition tests and priming paradigms respectively, (Schacter 1992, Fischer & Yan 2002). Though complex procedural tasks have been found in general to be more fragile, the importance of intrinsic cues, in overcoming this problem, is illustrated by (Shields, et al., 1979). Healy et al, (1998) also reviewed studies that found both good and bad retention of procedural skills by putting forward the proposal of procedural reinstatement. Procedural reinstatement (Healy, et al., 1998), contributes to the recall of complex tasks.

The tests for retention typically involve using the recall test or recognition test. Current literature highlights that recall and recognition tests are in various cases autonomous processes such that an individual's ability to recognise an event has no relationship to their ability to recall it (Flexer & Tulving, 1978). Different retention measures can yield different degrees of superficial retention, with recall tests usually of lower scores than the recognition tests (Farr, 1986). The aim of the research therefore was to design this study by blending cued recognition/recall techniques and pictographic displays as the tool of assessment and monitor the rate of skill decay within an interval of one and three-month after skill acquisition, (Hancock 2006, Meador & Hill 2011).

RESEARCH QUESTIONS

The following research questions will be addressed in this paper.

1. Is a 24 month retention interval too long?
2. What is the magnitude of procedural skill and knowledge decay over a three-month non-practice period and its safety implications?
3. Does forgetting over the three-month period occur at different rates for refresher⁷⁶ and fresher⁷⁷ participants?

Valid and reliable performance data will be needed to answer these questions.

⁷⁶ Those returning for training

⁷⁷ First time learners

METHOD

Participants

The research participants were those registered to undergo the basic RUK/GWO approved height safety and rescue training course- either refreshers or those attending for the first time (fresher). To achieve this representation, voluntary consent of the wind technicians was the standardised method of selection of those who agreed to participate. The study recruited 82 wind technicians/engineers in total over a three month period of data collection process, 27 participants in phase-1 from 22-26 July, 2013; 26 participants in phase-2 from 9-13 September 2013; and 29 participants in phase-3 from 30 September – 4 October 2013. The research participants with varying years of on-the-job experience were representative of the wider population which the study may wish to extrapolate.

Materials

The research implemented a longitudinal design approach for data gathering in order to track changes over time and establish the sequence in which events took place. Questionnaires were designed based on job knowledge inventory test (JKT) (Teachout, et al., 1993). This was used for the entire knowledge appraisal, from pre-acquisition to retention measurements. Hands-on practical scenarios were used during the pre-acquisition and acquisition stages for the skill assessment using the automatic constant rate descender (CRD) RG9A, (see Figure 1). Skill retention assessment was conducted online using situational judgment test (SJT) (Lievens, et al., 2008), with cued recognition/recall and pictographic displays.

The rescue device (type RG9A) is designed for emergency situations where rapid evacuation is required, (see Fig. 1). It can also be used for self-rescue or for the rescue of others. CRD's can be used for single or repeat descents for 1 or 2 person loads. The mechanism can work in either direction, allowing each subsequent evacuee to use the alternate end of the rope during consecutive descents. The device is fitted with a handle which can be used to raise casualties a short distance. The handle parks away into the device hub for descent operation; this is safety critical to avoid injury to the rescuer as the handle can freely spin when the device brake is not applied.

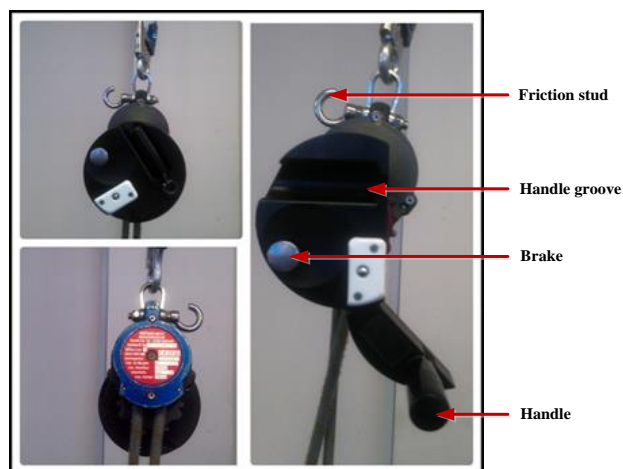

Figure 12: Automatic constant rate descender (CRD) RG9A

Design

One of the most commonly used and well known method for assessing the effectiveness of, or need for training is a job knowledge inventory test (JKT), (Lievens et al., 2008, Paulin et al., 2002). JKT is straightforward to develop and administer. They require individuals to answer multiple-choice questions related to on-the-job knowledge, skills, and abilities. JKT is very useful in the measurement of fundamental knowledge of technical information, (Teachout, et al., 1993) such as those used in the height safety, rescue and evacuation training course. Good JKT serves as a platform for providing an assessment of the degree to which the trainees possess the factual knowledge covered in a training course required to perform a task. They are useful as a job and training performance predictors and can also be used as criterion measures. For initial skill assessments, hands-on practical scenario was used during the pre-acquisition and acquisition stages. The trainees were required to procedurally use RG9A device to perform hands-on rescue and evacuation of a casualty by taking turns alternately. This was a full task training where trainees were instructed to focus on the whole process of rescue and not parts of the task. The training/acquisition also involved group facilitation which was an important motivational factor in group and team-based training protocols and conditions as observed by (Bandura, 1986). The skill retention assessment was presented online as written description of realistic job situations using cued recognition and recall with pictographic displays. Situational judgment tests (SJTs) are a type of psychological test which present the participants with realistic, hypothetical scenarios and ask the individual to identify the most appropriate response or to rank the responses in the order they feel is most effective and operational, (Lievens, et al., 2008). All the research participants were required to evaluate the randomized written performance description and the associated picture by rearranging the correct sequence of procedurally executing the use of RG9A for rescue and evacuation. Situational judgment tests tend to determine behavioural tendencies, assessing how an individual will behave in a certain situation, and knowledge instruction, which evaluates the effectiveness of possible responses (Muchinsky, 2012). In contrast to most psychological tests, the SJT was designed as an assessment tool adapted to appropriately suit the individual role requirements of the wind technicians after the rescue and evacuation training.

Procedure

The assessment for wind technicians involved procedure-based and system-based training where each group received averagely 6-8 hours of intensive training over two sessions. The Day-1 session involved mostly theoretical explanation (procedure-based) of all the methods that make up the training requirements e.g. elements of a safe system of work, equipment selection and inspection, use of tools, risk assessment, method statements and emergency procedures. The Day-2 session covered practical application (system-based) of all the procedures with emphasis on emergency rescue, how to approach rescue situations in wind turbine generators (WTG) and use rescue equipment efficiently. All participants were trained in exactly the same way, with an average of four trainees to an approved trainer. With consent from the training providers, the knowledge pre-acquisition test was administered before the training session and the acquisition test after Day-1 training in collaboration with the training instructors. The second wave of knowledge acquisition test was administered at the end of Day-2 training. Retention measures using job knowledge inventory test (JKT)

was conducted online at retention intervals of one and three-month bringing the sum total of assessment times to five sessions.

The pre-acquisition skill assessment was conducted using hands-on practical scenario based on performance in the use of RG9A for rescue/evacuation (refresher participants only). Data for skill acquisition was collected for all participants (refresher and fresher) after Day-2 training session. The acquisition assessment for skill was conducted after the participants had undergone training and attained some level of proficiency in the use of the rescue/evacuation device. This involved stepwise procedural performance of a rescue and evacuation process (lifting and lowering casualty) using the approved rescue device. Subsequently, follow-up of skill retention using situational judgement tests (SJT) was conducted online using cued recognition and recall with pictographic displays instigating the participants to correctly work out the step-by-step sequence/procedures of using the RG9A rescue device. The use of cued recognition and recall assessment with the aid of pictographic display better afforded the participants the opportunity to make use of their cognitive resources. Kanfer & Ackerman (1989) suggested that individuals have limited cognitive resources that are very important during initial skill acquisition.

PRELIMINARY RESULTS

Sample Characteristics

The preliminary analysis is based on a total of 30 participants that responded all through the three-month assessment (12 refresher and 18 fresher participants). This averages at 36.6% out of a total of 82 initial research participants. For most studies involving performance data expressed in error terms and that are positively or negatively skewed, such performance data undergo a square-root or log-transformation to reduce the skewness of the distribution. For these initial results, data presented have not been transformed.

Test of Normality

Interpretation of the test of normality using Shapiro-Wilk statistics was used to assess the normality of the distribution scores, (Shapiro & Wilk 1965, Razali & Wah 2011). The null hypothesis for this test of normality is that data are normally distributed. The null hypothesis is rejected if the p-value (sig) is below 0.05 of the distribution, which is statistically significantly different and not normally distributed. However, if the p-values (sig) are above 0.05, the null hypothesis is kept. The Kolmogorov-Smirnov test and the Shapiro-Wilk test most often give different p-values but the Shapiro-Wilk test is considered a more reliable alternative in the test of normality. The interpretation of skewness and kurtosis measures should be as close to zero as possible. The skewness and kurtosis z-values should be somewhere in the span of -1.96 to +1.96, however, data are often skewed and kurtotic. A small departure from zero is not much of a problem as long as the measures are not too large compared to their standard errors (SE), (Doane & Seward 2011, Cramer & Howitt 2004).

Table 1: Test of Normality (Refresher Skill)

	Kolmogorov-Smirnov ^a			Shapiro-Wilk		
	Statistic	df	Sig.	Statistic	df	Sig.
Skill Test score T ₀ pre-acquisition @ day 1	.172	19	.142	.888	19	.029
Skill Test score T ₁ acquisition @ day 2	.189	19	.073	.886	19	.027
Skill Test score T ₂ retention @ 1 month	.216	17	.035	.886	17	.040
Skill Test score T ₃ retention @ 3 months	.199	12	.200 [*]	.903	12	.174

*. This is a lower bound of the true significance.

a. Lilliefors Significance Correction

The normality of the skill test (refresher) scores for the data (see Table 1), and visual inspection of the histograms and normal Q-Q plots show that the sig-values for T₀ (.029), T₁ (.027) and T₂ (.040) are below the p-value 0.05 of the distribution. Therefore, they are statistically significantly different and not normally distributed and the null hypothesis of a normal distribution is rejected. The sig-value for T₃ (.174) is above the p-value 0.05, thus the null hypothesis is kept, indicating an approximately normally distributed data. The skewness and kurtosis values and measure of standard errors (SE) for the refresher participants are shown in the descriptive statistics as - skewness: T₀ = 0.675, SE = 0.524; T₁ = -0.738, SE = 0.524; T₂ = -0.320, SE = 0.550 and T₃ = -0.209, SE = 0.637. The kurtosis values are: T₀ = 0.037, SE = 1.014; T₁ = 0.264, SE = 1.014; T₂ = -1.160, SE = 1.063 and T₃ = -1.427, SE = 1.232.

Table 2: Tests of Normality^a (Fresher Skill)

	Kolmogorov-Smirnov ^b			Shapiro-Wilk		
	Statistic	df	Sig.	Statistic	df	Sig.
Skill Test score T ₁ acquisition @ day 2	.236	22	.003	.900	22	.029
Skill Test score T ₂ retention @ 1 month	.139	19	.200 [*]	.937	19	.234
Skill Test score T ₃ retention @ 3 months	.259	18	.002	.853	18	.009

*. This is a lower bound of the true significance.

a. Skill Test score T₀ pre-acquisition @ day 1 is constant. It has been omitted.

b. Lilliefors Significance Correction

Assessing the normality of the skill test (fresher) scores for the data (see Table 2), and a visual inspection of the histograms and normal Q-Q plots show that the sig-values for T₁ (.029), T₃ (.009) both fall below the p-value 0.05 of the distribution. Therefore, they are statistically significantly different and not normally distributed and the null hypothesis of a normal distribution is rejected. The sig-value for T₂ (.234) is above the p-value 0.05, thus the null hypothesis is kept, indicating an approximately normally distributed data. The skewness and kurtosis values and measure of standard errors (SE) for the fresher participants (skill) are shown in the descriptive statistics as - skewness: T₁ = 0.816, SE = 0.491; T₂ = 0.048, SE = 0.524 and T₃ = 0.072, SE = 0.536. The kurtosis values are: T₁ = 0.394, SE = 0.953; T₂ = -0.623, SE = 1.014 and T₃ = -1.693, SE = 1.038.

Table 3: Tests of Normality (Refresher Knowledge)

	Kolmogorov-Smirnov ^a			Shapiro-Wilk		
	Statistic	df	Sig.	Statistic	df	Sig.
Knowledge Test score T ₀ pre-acquisition @ day 1	.189	19	.072	.924	19	.134
Knowledge Test score T ₁ acquisition @ day 1	.270	19	.001	.748	19	.000
Knowledge Test score T ₂ acquisition @ day 2	.257	19	.002	.830	19	.003
Knowledge Test score T ₃ retention @ 1 month	.237	17	.012	.923	17	.167
Knowledge Test score T ₄ retention @ 3 months	.256	12	.029	.910	12	.214

a. Lilliefors Significance Correction

The assessment of the normality of knowledge test (refresher) scores for the data (see Table 3), and a visual inspection of the histograms and normal Q-Q plots show that the sig-values for T₁ (.000) and T₂ (.003) fall below the p-value 0.05 of the distribution. Therefore, they are statistically significantly different and not normally distributed and the null hypothesis of a normal distribution is rejected. The sig-value for T₀ (.134), T₃ (.167) and T₄ (.214) are all above the p-value 0.05, thus the null hypothesis is kept, indicating an approximately normally distributed data. The skewness and kurtosis values and measure of standard errors (SE) for the refresher participants are shown in the descriptive statistics as - skewness: T₀ = -1.018, SE = 0.524; T₁ = -2.110, SE = 0.524; T₂ = -0.522, SE = 0.524; T₃ = -0.753, SE = 0.550 and T₄ = 0.337, SE = 0.637. The kurtosis values are: T₀ = 1.782, SE = 1.014; T₁ = 4.943, SE = 1.014; T₂ = -0.918, SE = 1.014; T₃ = 1.828, SE = 1.063 and T₄ = -0.731, SE = 1.232.

Table 4: Tests of Normality (Fresher Knowledge)

	Kolmogorov-Smirnov ^a			Shapiro-Wilk		
	Statistic	df	Sig.	Statistic	df	Sig.
Knowledge Test score T ₀ pre-acquisition @ day 1	.132	22	.200	.953	22	.367
Knowledge Test score T ₁ acquisition @ day 1	.174	22	.083	.872	22	.008
Knowledge Test score T ₂ acquisition @ day 2	.437	22	.000	.603	22	.000
Knowledge Test score T ₃ retention @ 1 month	.197	19	.050	.927	19	.152
Knowledge Test score T ₄ retention @ 3 months	.230	18	.013	.870	18	.018

a. Lilliefors Significance Correction

Assessing the normality of the knowledge test (fresher) scores for the data (see Table 4), and a visual inspection of the histograms and normal Q-Q plots show that the sig-values for T₁ (.008), T₂ (.000) and T₄ (.018) are below the 0.05 of the distribution. Therefore, these three values are statistically significantly different and not normally distributed and the null hypothesis of a normal distribution is rejected. The sig-value for T₀ (.367) and T₃ (.152) are above the p-value 0.05, thus the null hypothesis is kept, indicating an approximately normally distributed data. The skewness and kurtosis values and measure of standard errors (SE) for the refresher participants are shown in the descriptive statistics as - skewness: T₀ = 0.009, SE = 0.491; T₁ = -1.509, SE = 0.491; T₂ = -1.660, SE = 0.491; T₃ = -0.383, SE = 0.524 and T₄ = -0.166, SE = 0.536. The kurtosis values are: T₀ = -0.481, SE = 0.953; T₁ = 3.077, SE = 0.953; T₂ = 1.687, SE = 0.953; T₃ = -0.657, SE = 1.014 and T₄ = -1.581, SE = 1.038.

RESULTS

Is a 24 month retention interval too long?

Figure 2 show the mean percentage performance scores for the skill assessment from pre-acquisition to retention. It highlights scores for both refresher and fresher participants. Both set of participants experience an increase in performance score from pre-acquisition to acquisition, peaking at 88% and 81% respectively. The development of skills is induced by the environment, and only the skills induced most consistently will typically be at the highest level that the individual is capable of. Analysis of skill structures plus control of environmental factors such as practice and familiarity allow the prediction of special instances of near-perfect synchrony, as well as predictions of various degrees of synchrony under differing circumstances, (Fischer, 1980). The refresher participants show 15.9% decline in performance level between the acquisition and 28-day retention, and 22.7% decline in performance level at the end of three-month. The fresher participants show 18.5% decline in performance level from

acquisition and 28-day retention, and 29.6% decline in performance level at the end of three-month. Figure 2 show refresher participants outperforming the fresher participants from acquisition to retention periods which suggest the probable influence factor might be as a result of previous training and experience. The participants have an optimal level which indicates the best performance they can achieve and which is presumably a reflection of both practice and the upper limit of his/her processing ability.

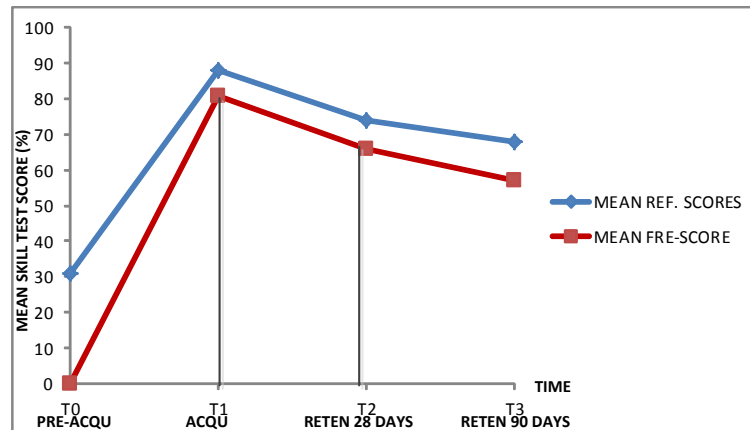

Figure 2: Mean score for skill assessment for refresher and fresher participants

Figure 3 show the mean percentage scores for the knowledge assessment across the assessment period from pre-acquisition to retention for both refresher and fresher participants. Both sets of participants display steady increase in knowledge score from pre-acquisition to acquisition averaging at 95% and 98% at acquisition. The refresher participants show 8.42% decline in performance level between the acquisition period and 28-day retention and 10.53% decline in performance level at the end of three-month. The fresher participants display an 18.4% drop in performance level from acquisition period and 28-day retention, and 21.4% drop in performance level at the end of three-month. Though this study reveals that at acquisition, both refresher and fresher participants can attain almost the same level of peak performance which in this case averages out at 95% and 98%, over the retention periods, the probable impact of previous training and experience of the refresher participants seem to enhance their ability to retain some knowledge longer than fresher participants. It shows that development is relatively continuous and gradual, and the participants are never at the same level for all skills, (Fischer, 1980).

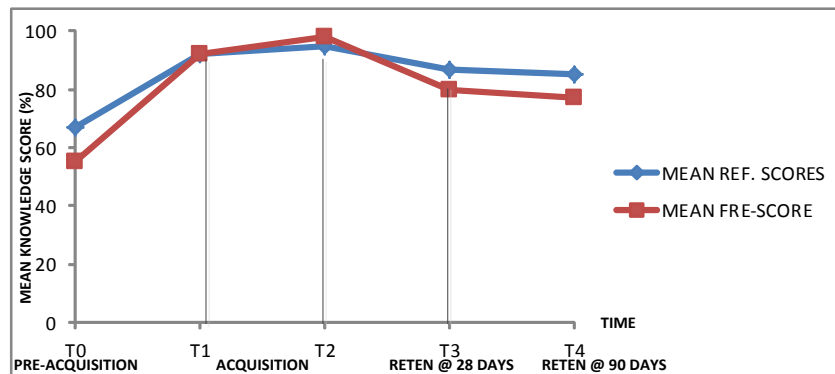

Figure 3: Mean score for knowledge assessment for refresher and fresher participants

What is the magnitude of procedural skill and knowledge decay over a three-month non-practice period and its safety implications?

The education sector has a history of setting 75% as the benchmark for passing score (McKnight, 1999). The magnitude of procedural skill and knowledge decay are shown (see Tables 5 & 6). The refresher participants show an average of 15.9% decline in skill performance score after 28-day and 22.7% after a period of three-month while the fresher participants show an 18.5% and 29.6% decline in skill performance level. The magnitudes of knowledge decay for refresher participants was 8.4% after 28 days retention and 10.5% after three months while that of the fresher participants are 18.4% and 21.4% respectively, (see Tables 5 & 6). Extrapolated results for skill and knowledge decay at 24 months was based on the initial performance of refresher participants assessed before undergoing the height safety and rescue training, (see Fig. 4).

Table 5: Magnitude of skill decay over one and three month period – Skill assessment

Time	Skill performance (%)		Magnitude of decay (%)	
	Refresher	Fresher	Refresher	Fresher
T ₀	30	0		
T ₁	88	81		
T ₂	74	66	15.9	18.5
T ₃	68	57	22.7	29.6
*T _{24M}	*30	*	*65.9	*

*T = extrapolated time at 24 months

Table 6: Magnitude of knowledge decay over one and three month period – Knowledge assessment

Time	Knowledge performance (%)		Magnitude of decay (%)	
	Refresher	Fresher	Refresher	Fresher
T ₀	67	55		
T ₁	92	92		
T ₂	95	98		
T ₃	87	80	8.4	18.4
T ₄	85	77	10.5	21.4
*T _{24M}	*67	*	*29.5	*

*T = extrapolated time at 24 months

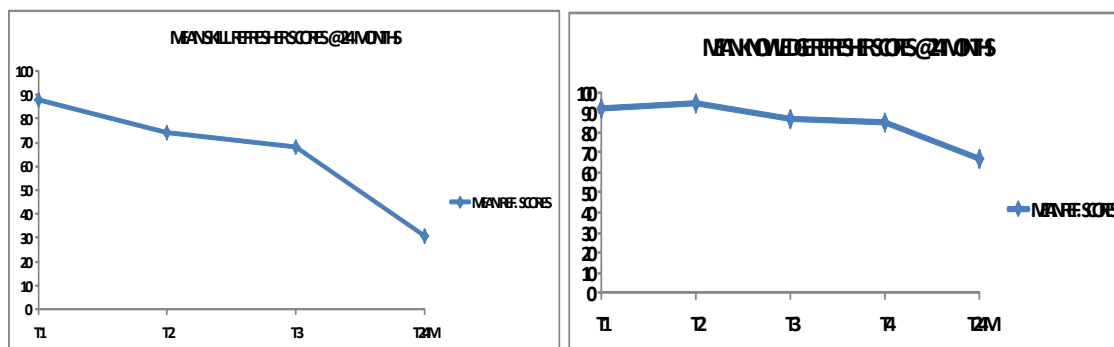

Figure 4: Extrapolated means for skill & knowledge score for refresher participants at 24 months

Does forgetting over the three-month period occur at different rates for refresher and fresher participants?

Figures 2 & 3 indicate that ‘forgetting’ for refresher and fresher participants occurred at different rates over the three-month period. The refresher participants over the course of the assessment session had a better performance level than the fresher participants in the skill and knowledge tests. Tables 5 & 6 also replicate the raw mean scores for both set of participants over the assessment period and the differential rates of decay.

DISCUSSION

Firstly, the preliminary results show that skill and knowledge retention of wind technicians in the use of rescue device (type RG9A) for emergency rescue and evacuation declined rapidly within 28-day after acquisition and moderately towards the three-month retention interval. This result show some similarity with the works of (McKenna & Glendon, 1985), whose report revealed that less than a 25% of their trained personnel were skilful at performing the procedural task six months after training. Wisher et al., (1991), also found in their reports that knowledge about job decayed mostly within 6 months while skills decayed mostly after 10 months; though they did not quantify how much decay. Although (Marmie & Healy, 1995) recorded significant decline in retention rate from their studies within one-month and six-month retention test, they stated it was statistically significant. Another study by Osborne et al., (1979), cited in (Hagman & Rose, 1983) found that with uncued steps at the beginning and end of a process, as well as those addressing safety and those judged to be "difficult", they are least likely to be recalled. There are conflicting results from literature in the consideration of the rate of retention of cognitive/procedural skills. Some studies have found that these skills are less prone to decay (Arthur Jr., et al., 1998) however this is in contrasts to report by (Driskell, et al., 1992) who found that they deteriorate quicker than motor skills. Wisher et al., (1999) stated that cognitive skills "tend to be stable for long periods over time however people do exhibit forgetting". One of the main factors, whether direct or an intervening variable, is the time interval between training and performance. It is therefore not a surprise that the longer the time between practice and performance, the greater will be the skill loss. Studies have consistently found skill loss over time where performance decreases rapidly soon after training then occurring at an increasingly slower rate, which seem to be the case for this study, (Arthur Jr. et al., 1998, Wixted & Ebbesen, 1991).

According to (Driskell et al., 1992, Wixted & Ebbesen, 1991), this pattern appears to be consistent across a variety of skills and tasks.

Secondly, the magnitude of skill and knowledge retention appeared to decline rapidly within the first three-month, though this is most significant in skill than knowledge. A common argument regarding this is based on the feedback the trainees received during acquisition. When such feedback contains information about the magnitude and direction of performance errors, then it directs the trainees towards ways of correcting the error and improving performance. The impact of skill decay or knowledge loss has also been associated with infrequent or the total absence of feedback (Hurlock & Montague, 1982, Driskell et al., 1992). The kinds of feedback provided to the trainees during acquisition affect retention, depending on the content of the information. Thirdly, 'forgetting' over the three-month period occurred at different rates for refresher and fresher participants. The refresher participants tend to perform better on average than the fresher participants. This is shown in the mean scores for both skill and knowledge tests (see Figures 2 & 3, Tables 5 & 6), where the refresher participants outperform the fresher participants in both skill and knowledge retention tests. It should be noted that the degree of successful performance of an individual on any of these tests is largely dependent on the learning experience, or the type of practice and instruction received. Shields et al., (1979) identified amongst other factors accountable for most of the differences in retention that most task steps that are forgotten tend to be those that are not suggested by the previous sequence of steps or by the equipment. The initial level of learning which is obviously related to the amount of initial training is one of the most important factors in determining retention (Hurlock & Montague, 1982). An individual's level of initial proficiency has a direct relationship with the level of skill retention, and relation between recall success and skill level (Watson & Fischer, 1977).

CONCLUSIONS

In accessing the relative costs and benefits of sustaining procedural skills, extra training enhances retention regardless of whether it is during initial training or conducted as a refresher course afterwards. It is recommended that fresher participants receive earlier refresher training to improve their proficiency based on these results. At the moment, there is no consideration of this factor. These could be simulation-based, which has been found to increase the retention rates over a longer time frame. Feedback during the acquisition of skills which highlights the magnitude and direction of performance errors should be embedded in training as it is found to impact retention rate negatively when absent. Forgetting over a three-month period was also found to vary between the refresher and fresher participants. This effect can be related to the level of initial learning which is obviously related to the amount of initial training received by the refresher participants. Further work will have to be done to determine a desirable failure threshold for the trainees involved in the use of the rescue and evacuation device during emergency situations. This is amongst the pressing questions that the future investigation will be attempting to define.

REFERENCES

- Arthur Jr., W., Bennett Jr., W., Stanush, P. L. & McNelly, T. L., 1998. Factors that influence skill decay and retention: A quantitative review and analysis. *Human Performance*, 11(1), pp. 57-101.
- Arthur, J. W. et al., 2007. *Decay, Transfer, and Reacquisition of a Complex Skill: An Investigation of Practice Schedules, Observational Rehearsal, and Individual Differences*, Woburn, MA: Aptima, Inc..
- Bandura, A., 1986. *Social foundation of thought and action: A social cognitive theory*. Englewood Cliffs, NJ: Prentice Hall.
- Cramer, D. & Howitt, D., 2004. *The SAGE dictionary of statistics*. London: SAGE.
- Doane, D. P. & Seward, L. E., 2011. Measuring Skewness. *Journal of Statistics Education*, 19(2), pp. 1-18.
- Driskell, J. E., Willis, R. P. & Copper, C., 1992. Effect of overlearning on retention. *Journal of Applied Psychology*, Volume 77, pp. 615-622.
- EU-OSHA, 2013. *European Agency for Safety and Health at Work*. [Online] Available at: <https://osha.europa.eu/en/publications/reports/green-jobs-foresight-new-emerging-risks-technologies> [Accessed 22 January 2014].
- EU-OSHA, 2013. *Occupational safety and health in the wind energy sector - European Risk Observatory*, Luxembourg: European Agency for Safety and Health at Work.
- Farr, M. J., 1986. *The long-term retention of knowledge and skill: A cognitive and instructional perspective*, Alexandria, Virginia: Institute for Defense Analyses.
- Fischer, K. W., 1980. A Theory of Cognitive Development: The Control and Construction of Hierarchies of Skills. *Psychological Review*, 87(6), pp. 477-531.
- Fischer, K. & Yan, Z., 2002. The Development of Dynamic Skill Theory. In: R. Lickliter & D. Lewkowicz, eds. *Conceptions of development: Lessons from the laboratory*. Hove, UK: Psychology Press, pp. 279-311.
- Flexer, A. J. & Tulving, E., 1978. Retrieval independence and recall. *Psychological Review*, Volume 85, pp. 153-171.
- Global Wind Organisation Standard, 2013. *Basic Safety Training (BST) (Onshore/Offshore)*, s.l.: Global Wind Organisation Standard.
- Hagman, J. D. & Rose, A. M., 1983. Retention of military tasks: A review. *Human Performance*, 25(2), pp. 199-213.
- Hancock, R. A., 2006. *Decay in AN/PSS-14 Operator Skill at 30, 60, & 90 Days Following Training*, Aberdeen, MD: U.S. Army Research Laboratory .
- Health & Safety Executive, 2007. *Development of a working model of how human factors, safety management systems and wider organisational issues fit together - RR543*, London: HSE.
- Health and Safety Executive, 1997. *Successful health and safety management - (HSG65)*, London: HSE - ISBN 978 0 7176 1276 5.
- Health and Safety Executive, 1999. *Reducing error and influencing behaviour - HSG48*, Surrey: HSE.

- Health and Safety Executive, 2003. *Health and safety regulation - a short guide*. [Online] Available at: www.hse.gov.uk/pubns/hsc13.pdf [Accessed 2 April 2014].
- Healy, A. F. et al., 1998. *The Long-Term Retention of Knowledge and Skills*, Alexandria, VA: U.S Army Research Institute.
- Hurlock, R. E. & Montague, W. E., 1982. *Skill retention and its implications for navy tasks: An analytical review*, San Diego, California 92152: Navy Personnel Research and Development Center.
- Kanfer, R. & Ackerman, P. L., 1989. Motivation and cognitive abilities: An integrative/aptitude-treatment interaction approach to skill acquisition. *Journal of Applied Psychology*, 74(4), pp. 657-690.
- Kim, J. W., Koubek, R. J. & Ritter, F. E., 2007. *Investigation of Procedural Skills Degradation from Different Modalities*. Oxford, UK, Taylor & Francis/Psychology Press, pp. 255-260.
- Konoske, P. J. & Ellis, J. A., 1991. Cognitive factors in learning and retention of procedural tasks. In: *Instruction: Theoretical and applied perspectives*. New York: Praeger, pp. 47-70.
- Lievens, F., Peeters, H. & Schollaert, E., 2008. Situational judgment tests: a review of recent research. *Personnel Review*, 37(4), pp. 426 - 441.
- Marmie, W. R. & Healy, A. F., 1995. The long-term retention of a complex skill. In: *Learning and memory of knowledge and skills: Durability and specificity*. Thousand Oaks, CA: Sage Publications, pp. 30-65.
- McKenna, S. & Glendon, A., 1985. Occupational first aid training: Decay in cardiopulmonary resuscitation (CPR) skills. *Journal of Occupational Psychology*, Volume 58, pp. 109-117.
- McKnight, A. J., 1999. *Guidelines for Knowledge and Skills Testing*, USA: American Association of Motor Vehicle Administrator.
- Meador, D. P. & Hill, R. R., 2011. Modeling Training Effects Using a Human Performance Taxonomy. *Human Factors and Ergonomic Society* 53(4), pp. 391-402.
- Muchinsky, P. M., 2012. *Psychology Applied to Work*. Tenth ed. Summerfield, NC: Hypergraphic Press.
- Paulin, C., McKee, A. F., Hanon, M. A. & Hedge, J. W., 2002. *Development of criterion measures to assess retention and decay of aerospace physiology knowledge and skills*, Mesa, AZ: Huamn Effectiveness Directorate.
- Razali, N. M. & Wah, Y. B., 2011. Power comparisons of Shapiro-Wilk, Kolmogorov-Smirnov, Lilliefors and Anderson-Darling tests. *Journal of Statistical Modelling and Analysis*, 2(1), pp. 21-33.
- Reason, J., 1990. The contribution of latent human failures to the breakdown of complex systems. *Philosophical Transaction of the Royal Society London, Series B*, 327(1241), pp. 475-484.
- RenewableUK, 2014. *Entry- and Basic-Level Health & Safety Training and Competence Standards: Scope and Application to Large Wind Projects*, London: RenewableUK.
- Schacter, D. L., 1992. Priming and multiple memory systems: Perceptual mechanisms of implicit memory. *Journal of Cognitive Neuroscience* 4(3), pp. 244-256.
- Shapiro, S. S. & Wilk, M. B., 1965. An analysis of variance test for normality (complete samples). *Biometrika*, 52(3/4), pp. 591-611.

- Shields, J. L., Goldberg, S. L. & Dressel, D. J., 1979. *Retention of basic soldiering skills*, Alexandria, VA: U. S. Army Research Institute for the Behavioural and Social Sciences.
- Teachout, M. S., Winston, B. J. R., Barham, B. & Phalen, W. J., 1993. *Determining Intervals for Aerospace Physiology Refresher Training: An Approach for Research*. Williamsburg, Virginia, s.n., pp. 456-461.
- Watson, M. W. & Fischer, K. W., 1977. A developmental sequence of agent use in late infancy. *Child Development*, Volume 48, pp. 828 - 835.
- Wisher, R. A., Sabol, M. A., Sukenik, H. K. & Kern, R. P., 1991. *Individual Ready Reserve (IRR) Call-Up: Skill Decay*, Arlington, VA: The US Army Research Institute for Behavioural and Social Sciences.
- Wisher, R. A., Sabol, M. A., Ellis, J. & Ellis, K., 1999. *Staying Sharp: Retention of Military Knowledge and Skills*, Arlington, VA: US Army Research Institute for Social and Behavioral Research.
- Wixted, J. T. & Ebbesen, E. B., 1991. On the form of forgetting. *Psychological Science*, 2(6), pp. 409-415.

NANOPARTICLES – ARE THEY SAFE AND WHY SHOULD WE CARE ANYWAY? INTRODUCING A NEW RESEARCH INITIATIVE

Gibb, A.G.F.⁷⁸, Bust, P.D.¹, Goodier, C.I.¹ and Song, M.²

¹ *School of Civil & Building Engineering, Loughborough University, UK*

² *Department of Materials, Loughborough University, UK*

A wide range of nano-scale particles, around a thousand times smaller than the thickness of a human hair, are being manufactured to revolutionise existing technologies and products producing step-changes in performance. They are widely used throughout society: medicine, medical treatments, cosmetics, food preparations and the built environment. In the built environment, they are found in self-cleaning glass, high strength bolts and welds, self-healing paint – basically any product that has delivered step change performance in the last few years. Some are probably benign but there is significant research showing that some are hazardous to health and carbon nanotubes are particularly cited. They are probably ‘safe’ when they remain bonded into the product or material, but, if they become bioavailable they have inhalation, ingestion and dermal pathways into humans. Some construction, maintenance, refurbishment and demolition activities could make the particles bioavailable. We do not know what types of nanoparticles are incorporated in which building products and we do not know where they are anyway. The immediate challenge is to find out where they are and record the information – probably in the project’s Health and Safety File that is passed on to the building or facility owner/operator. This paper describes a new research project by the authors aiming to work out what nano is where, and how the nanoparticles can become bioavailable to then to produce pragmatic guidance for practitioners.

Keywords: nanotechnology, health risk, new research.

INTRODUCTION

Nanotechnology is an exciting, innovative area, promising great benefits to many areas of life, industry and commerce, including construction and the built environment. Particles, a thousand times smaller than the thickness of a human hair are now manufactured and incorporated within many products used on a day to day basis. Nano-enabled products include cosmetics, food supplements, and computer hardware components. Built environment examples include self-cleaning glass, special concretes, extra strength bolts and welds, and special paints.

The nano-revolution seems impossible to stop. Notwithstanding, there remain significant evidence-based concerns about health impacts from nanotechnologies that should not be ignored. Despite much rhetoric, governments world-wide are advising prudence but actually doing nothing to facilitate a prudent approach. Despite thousands of research projects, there appears to be no pragmatic evidence-based

⁷⁸ a.g.gibb@Lboro.ac.uk – *cib W099 Construction Health & Safety Conference, Lund, Sweden 6 14*

advice on the hazards and on what precautionary measures would be effective. As humankind, we do not know which materials contain nanoparticles; we do not know which particular nanoparticles are present; we do not know how easily they could become bioavailable; and we do not know what to do if they do become bioavailable.

Nanotechnology has now been coined by economists as the dawn of a new industry for the 21st century which could rank it alongside the automobile and microelectronics industries (Guiot et al, 2008). In the early years the image of this new industry was coloured by the references in science fiction literature to ecophagy (the literal consumption or destruction of an ecosystem) with doomsday scenarios of nanobots, using all carbon life forms on earth to self-replicate resulting in the Grey Goo outcome (Freitas, 2000). These worries have not materialised and the industry has flourished, but the speed of growth and the small particle sizes have led to comparisons with asbestos, both as a wonder material and the resultant health problems. Unfortunately the evidence has not yet dispelled these concerns as there is a lack of toxicology data on engineered nanoparticles. Therefore it is not possible to adequately assess the risk of the use of nanomaterials and there have been calls for a precautionary halt to nanoparticle development (Oberdörster et al, 2005). This has not happened and it is necessary for the epidemiology research to 'play catch up' with nanoparticle development.

Nanoparticles are not a single group of objects but a multiplicity of shapes, sizes and compounds – the definition for a nanoparticle is that one of its dimensions must be less than 100nm. Figures 1 and 2 show carbon nanotubes that are manufactured by rolling up a nano-scale sheet of graphene. It is hard to grasp the small size of nanoparticles. Figure 3 is one effort to illustrate their relative size.

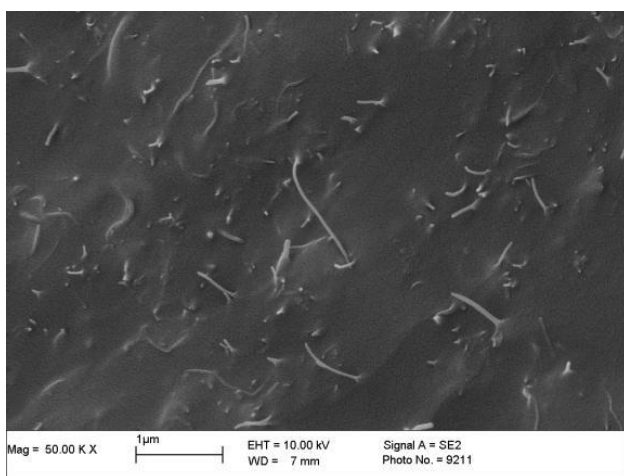

Figure 1 Carbon nanotubes in

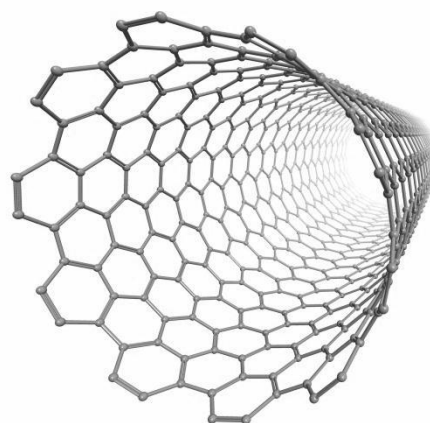
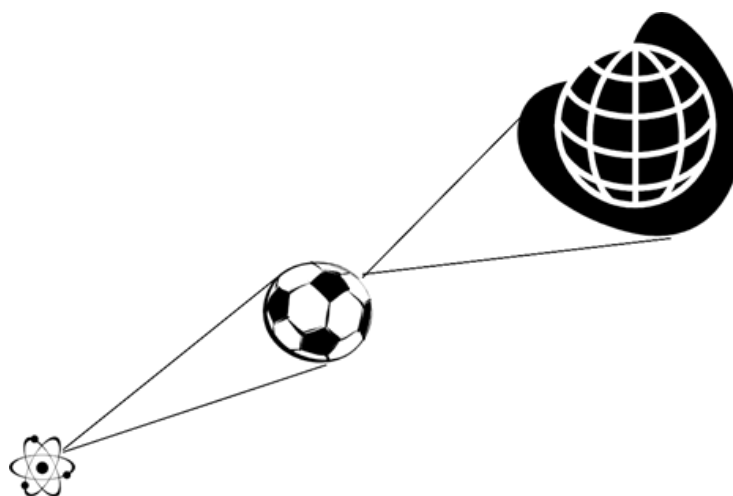

Figure 2 Artist's impression of a thermosetting material (much magnified!) single-walled carbon nanotube (©Dreamstime with permission)

A unifying feature of nanoparticles is that they are smaller than the materials they replace, and have larger surface area per unit mass. These parameters increase the toxic potential of a material (HSE, 2004). Nanoparticle use in an ever increasing number of industries grows each day. They are manufactured by many new companies and added to existing materials such as coatings and adhesives or used with other materials to create new products. In 2006 there were 212 consumer products or product lines incorporating nanomaterials, but, by 2011, there had been a

521% increase (1,317) in nano-enabled products available from more than 24 nations (NIOSH, 2014). This means that they are currently being manufactured, stored, transported, used and probably discarded as waste, thus increasing the possibility of the particles being released into the environment. Some balance between risk and



opportunity is required: “this new industry can develop dynamically only if the safety issues are solved during all the life cycle of the nano products: from fabrication to the end of life through usage” (Guiot et al, 2008).

Figure 3 Dimensions at the nanoscale (Elvin, 2007)

This paper describes a new research project by the authors aiming to work out what nano is where, and how the nanoparticles can become bioavailable to then to produce pragmatic guidance for practitioners.

POTENTIAL IMPLICATIONS FOR OCCUPATIONAL HEALTH

There is increasing concern about the lack of research into potential impacts of nanoparticles on workers’ health (e.g. Gibson et al, 2009). A European report on health and consumer protection describes the potential release of nanoparticles. The European Commission report on the fate of nanoparticles in the environment (EC, 2005) identifies the trigger as “deliberate or accidental release in one or more environmental compartments”. This leads to photochemical change; binding to other particles or surfaces and altered surface characteristics. This, in turn, leads to further dispersal in water, air or soil and uptake by biological organisms which may include sources of human food. This could result in bioaccumulation in the food chain; biodegradation and other adverse effects (ecotoxicological hazards). The report finds that there is minimal literature on the effects of nanoparticles on environmental species and only a few studies investigated species used for ecotoxicological testing (EC, 2005).

The likelihood of nanoparticles or nanotubes being released from products in which they have been fixed or embedded (e.g. composites) is expected to be low, but it is recommended that manufacturers assess this potential exposure risk throughout the product lifecycle and make their findings available to the regulatory bodies (RS-RAEng, 2004). There appears to be little evidence of this happening in that there is no evidence of this in the relevant reports (e.g. NIOSH, 2014; EEA, 2013, HSE, 2013). Led by the biomedical and electronic industries, construction is seeking ways of improving the performance of conventional materials using nanomaterials to improve

strength, durability and lightness, endow useful properties (e.g. heat-insulating, self-cleaning and antifogging) and function as key sensing components to monitor construction safety and structural health (Lee et al, 2010). The term “greater risk than previously thought” is now appearing in articles concerning production and use of products containing nanoparticles. Kipen and Laskin (2005) refer to studies suggesting that workers exposed at the current permissible exposure level may risk developing pulmonary fibrosis.

Currently, legislation is aiming at a moving target as technology accelerates. It is important to catch up with new innovations in product design and manufacture and this research endeavours to set a standard for product testing for nanoparticle release. A recent European Environment Agency report (EEA, 2013) states that “there remains a developmental environment that hinders the adoption of precautionary yet socially and economically responsive strategies in the field of nanotechnology.”

NANOTECHNOLOGY IN THE BUILT ENVIRONMENT

Table 1 has been developed by the authors to indicate the probable nano-type for some common construction and built environment products and materials, from data gathered from the National Building Specification (NBS, 2014) and supplemented by the authors’ previous research studies and experience. The different types of nanoparticle are believed to present different levels of hazard.

Table 1 Probable nano-type for some common construction products and materials

Product/Material	Carbon Nanotube	Graphene	Clay	TiO2	Silver	Polymer	ZnO	Al2O3	SiO2
Nano-cement	X						X	X	X
Self-healing concrete	X								
High strength composites	X	X	X			X			
Steel cables with copper nano	X								
High-strength bolts	X								
High-strength welded joints	X								
Fire protection	X	X	X			X			
Self-cleaning				X	X				
‘Paint’ coatings – e.g. Wi-Fi block		X	X	X	X	X			
Flexible solar panels	X	X							
Water filters				X					X
Aerogel insulation						X			
Electronics	X	X							
Ceramics	X	X		X	X		X	X	X

There is a plethora of recent research on nanotechnology. For example, the Organisation for Economic Cooperation and Development (OECD, 2014) lists 729 recent research projects in the field (<http://webnet.oecd.org/nanomaterials>). However, whilst a number refer to health concerns, very few world-wide are starting to consider implications on construction. One example is the EU's 'Scaffold' initiative (Scaffold, 2014): innovation strategies, methods and tools for occupational risks management of manufactured nanomaterials in the construction industry. This is a new initiative and is still to 'gather steam', but they acknowledge that "occupational exposure to these emerging risks may be accidentally or incidentally produced at different stages of the construction industry life cycle". They also concur that scientists are only just starting to understand the risks and that "detailed information about the product composition and their possible nano-specific health and safety issues is generally lacking... as a consequence, for the average construction company it will be very difficult to conduct a proper risk assessment and organise a safe workplace for its employees" (Scaffold, 2014).

Notwithstanding the extent of research in the field, there is still an almost complete lack of awareness of the use of nanotechnologies in the built environment. In a survey of 332 UK designers and design OSH (Occupational Safety & Health) advisors by the authors in 2012 demonstrated that, although a few had heard of the term nanotechnology, almost none believed that they had ever specified nano-enabled products on their projects. Their shock was almost measurable once they were presented with a list of the types of products that contain nanoparticles.

However, a considerable number of discussions involving the authors suggest that interest is growing rapidly. This is further evidenced by the attendance of more than 100 construction professionals at the webinar on the subject organised by the Institution of Occupational Safety and Health (IOSH, 2014).

IOSH-FUNDED NANO-HEALTH RESEARCH

Research project background and aims

It was mentioned previously that there has been little nano research relating to the built environment. However, the Institution of Occupational Safety and Health (IOSH), that represents OSH practitioners across all industry sectors, has recently commissioned research into nano and the built environment, focussing on demolition and recycling activities. This research is timely and relevant for the built environment in the 21st century, taking a step forward in an area with massive potential but also significant risks that are largely going unnoticed or ignored across the world.

The project will:

Catalogue products used in the built environment that incorporate nanoparticles

Catalogue the type(s) of nanoparticle in each product

Equate the types of nano with the relevant hazard and risk based on published data

Establish the likely demolition and recycling techniques for such products

Test selected samples of such products to establish the bioavailability of the nanoparticles from likely demolition and/or recycling techniques.

Produce guidance for IOSH practitioners and industry stakeholders on nanotechnologies in the built environment

Research Methods

Desk study, procurement of samples and determination of testing criteria

A systematic review of the key international medical and scientific publications on what is an emerging field of information will contribute directly to the deliverables and enable interview protocols to be established. Particular focus will be on the types of nanoparticle that are more hazardous, on materials and components that contain these particles and on the mechanisms for particles to become bioavailable, particularly those activities that are likely to be used in demolition and recycling.

An extensive product search will establish the range of materials, components and products used in the built environment that contain nanotechnologies – this is expected to be predominantly a web-based search. This will identify candidate products for the experiments.

The qualitative methods of face to face interviews and focus group sessions with construction industry professionals (n=50) will collect qualitative data on existing knowledge on the range and types of products in use in the life-cycle of the built environment and on methods of handling, installation, maintenance, refurbishment, demolition and recycling of materials and components containing nanotechnology. The interviews and focus groups will illicit information to provide a foundation for the preparation of communication tools (text and multimedia) for industry guidance on the management of potentially hazardous materials. Interviews with demolition and recycling experts will inform the test regime for nanoparticle release.

Samples of candidate materials will be obtained, where possible from collaborating companies, but most probably by direct purchase. This will be necessary since it is unlikely that samples would be provided free of charge by manufacturers once the nature of the research is declared in accordance with the ethical procedures.

Materials testing methods

Construction, repair, renovation and demolition could result in the release of nanoparticles from some (or all) of the nanomaterials. A full assessment of this release of particles for each stage is beyond the scope of this project as a number of tests require considerable time to complete and this has led to a more specific focus on the demolition phase.

The products and materials will be studied first to establish their chemistry and then identify the presence and type of nanoparticles. They will then be subjected to a series of processes to be finally agreed with demolition experts from the Institute of Demolition Engineers (IDE) to mirror techniques likely to be used in future demolition and recycling of such components. These are expected to include but not be limited to: fracture, distortion, grinding and burning. The term ‘fractured surface’ is used to represent all of the resultant surfaces following demolition or recycling interventions irrespective of the methods employed.

The following are the main experimental procedures:

- DSC Differential Scanning Calorimetry
- TGA Thermogravimetry

- Raman A form of spectroscopy to determine chemical structure
- FTIR Fourier Transform Infrared Spectroscopy
- SEM Scanning Electron Microscopy
- XRD X-ray diffraction

Identification and characterisation of nanomaterials

Thermal analysis (DSC, TGA), Raman and Fourier transform infrared spectroscopy (FTIR), scanning electron microscopy (SEM), transmission electron microscopy (TEM), and X-ray diffraction (XRD) will be used to identify what nanoparticles are present in the selected products and materials. This will include chemical information of the nanoparticles, nanoparticle size and loading quantity, dispersion of the nanoparticles in the matrix, interaction between nanoparticles and the matrix.

For identification of nanomaterials, the size of samples will be very small: DSC: 10-20mg; Raman and FTIR: 1-5g; TGA: 20mg, SEM/TEM: 1-5g. Tests will include: chemical structure (FTIR and Raman), size and distribution of nanoparticles in the matrix (SEM/TEM), and percentage of nanoparticle in the matrix (TGA).

Understanding the control of the release and migration of nanoparticles

Based on the investigation of effects of temperature, pressure, humidity, particle-matrix interactions on the release and migration of nanoparticles, the tests will optimise the processing conditions for minimisation of the release and migration of nanoparticles from the matrix.

Breaking by force, cutting using mechanical grinders and general burning of materials will be used in specimen preparation. The size of specimen will be different in the testing of the release of nanoparticles from the fracture surface (including coating surface): Experimental conditions will include: different temperatures (-30 -40°C), pressures (low to high), water flows and surface frictions (designed and controlled) to simulate demolition practices and different thermal ageing stages. These effects on nanoparticle release will be quantitatively assessed. SEM, TAG, assessment of weight loss will be carried out.

Release of nanoparticles from fractured surface including coating surface

SEM, TGA, XRD and FTIR will be used to observe the release of nanoparticles from the fractured surface. The release against temperature, time, pressure and humidity will be assessed. Due to the different interaction strengths of nanoparticles with matrixes, the release rate of nanoparticles from the fractured or damaged surface will be different. The effect of interaction strength on the release of nanoparticles will also be assessed.

The release of nanoparticles from matrices could become easy at high temperature due to the high mobility of nanoparticles. Two factors: the change of density and weight loss can be used to assess the nanoparticle release. The change of the density on the fractured surface can be observed by means of microscopy techniques. The weight loss can be monitored by weighing methods. A release- temperature time relationship curve for each particular construction manufactured nanomaterial can be established.

In addition to demolition and recycling interventions, wind, sand and rain could cause an external abrasive force on the surface which will lead to the release of nanoparticles from matrices. This would have occurred prior to demolition. Therefore, some assessment on the nanoparticle release is also necessary. For

stimulation of the process, a simple experimental instrument with controlled water flow capacity will be used to investigate the environmental effect on nanoparticle release.

Nanoparticle release rate with water flow, pressure, time and temperature: Due to material ageing (in this stage will focus on thermal), the interactions between nanoparticles and the matrix will become weak which will lead to acceleration of nanoparticle release. The research result could be valuable for demolition involving manufactured nanomaterials. The assessment methods on material ageing will be adopted directly. Effect of material ageing on nanoparticle release can be obtained. The nanoparticle release rate with material ageing will be established.

Additional tests will be developed following input from demolition and recycling experts to simulate the likely situation during the end of a building's life.

For the migration of release of nanoparticles from the matrix, the size of specimen will be 1 x 10 x 10cm and 10 x 10 x 10 cm. Experimental conditions will include different temperatures and pressures. FTIR, SEM and XRD will be used to monitor the change of concentration of nanoparticles in the surface.

SEM, TAG, XRD, FTIR and Raman methods will be used to assess the effects of temperature, pressure, humidity and particle-matrix interactions on the migration of nanoparticles.

Concentration of nanoparticles in air due to the release of nanoparticles from fractured surfaces will be assessed by means of FTIR, Raman, SEM and absorption methods. The effects of temperature, pressure, humidity, particle-matrix interactions and gravity will be investigated.

CONCLUSIONS

As mentioned previously, nanotechnologies are a reality for the built environment – the issue for safety and health of both workers and the public is one of effective management of the technologies. If the comparison with asbestos is valid only in a minor way or only with reference to part of the nanotechnology spectrum, then this project will be making a massive step in the improvement of safety and health and in the saving of many lives.

Even if the project does no more than identify the significant products that incorporate nanoparticles then this, in itself, will provide the opportunity for these items to be noted and their location recorded, for instance in the facility's health and safety file. This will enable future maintenance, demolition and recycling workers to take appropriate precautions, remembering that, with asbestos, the most difficult situation is when its location is unknown.

It may even be possible through the use of technological advances using nanotechnology to improve occupational health for countless number of workers worldwide. By considering the demolition stage of the construction process and the likely release of nanoparticles this work will enable others to complete life cycle assessments on the introduction of the increasing number of opportunities for novel products and technological solutions using nanomaterials.

This project will also develop a method for assessment of nanoparticle release in construction manufactured nanomaterials.

This project will assist in the understanding of exposure of workers to engineered nanoparticles by providing a catalogue of materials used in the construction process containing the particles together with information pertaining to the release of the particles through typical operations used in the demolition and recycling processes. This would then be able to be incorporated into research by those who are assessing the occupational health effects of engineered nanomaterials and arguing for a clear need to gather experimental, clinical and epidemiological data for the purpose of characterizing the relationship between exposure and health outcomes.

REFERENCES

- EC: European Commission Health & Consumer Protection DG (2005) Scientific Committee on Emerging and Newly Identified Health Risks on the appropriateness of existing methodologies to assess potential risks associated with engineered and adventitious products of nanotechnologies.
- EEA: European Environment Agency (2013) Late Lessons from Early Warnings: Science, Precaution, Innovation. EEA Report No. 1/2013.
- Elvin, G (2007) Nanotechnology for Green Building, Green Technology Forum, http://esonn.fr/esonn2010/xlectures/mangematin/Nano_Green_Building55ex.pdf [accessed 30/01/14].
- [Freitas](#), R (2000) Some Limits to Global Ecophagy by Biovorous Nanoreplicators, with Public Policy Recommendations, <http://lifeboat.com/ex/global.ecophagy> [accessed 29/01/14].
- Gibson, R M, Adishes, A, Bergamaschi, E, Berges, M, Bloch, D, Hankin, S, Lynch, I. & Riediker, M (2009) Strategies for assessing occupational health effects of engineered nanomaterials. Report submitted to The European Network on the Health and Environmental Impact of Nanomaterials under the European Commission's Seventh Framework Programme.
- Guiot, A, Luana Golanski, L, & Tardif, F (2008) Measurement of nanoparticle removal by abrasion. Nanosafe 2008: International Conference on Safe production and use of nanomaterials. IOP Publishing. "Journal of Physics" Conference Series 170 (2009) 012014.
- HSE (2004) Nanoparticles: an occupational hygiene review, HSE, Caerphilly UK.
- HSE (2013) HSG272, Nanomaterials at work, www.hse.gov.uk/pubns/books/hsg272.pdf [accessed 05/01/14].
- IOSH (2014) Nanotechnology webinar, www.iosh.co.uk/nanowebinar [accessed 20/04/14].
- Kipen, H & Laskin, D (2005) Smaller is not always better: nanotechnology yields nanotoxicology, *AJP Lung Cell Mol Physiol*, 289.
- Lee, J, Mahendra, S & Alvarez, P (2010) Nanomaterials in the Construction Industry: A Review of Their Applications and Environmental Health and Safety Considerations, *ASCNANO*, 4(7), 3580-3590.
- NBS (2014) National Building Specification, www.thenbs.com [accessed 05/01/14].
- NIOSH (2014) Current Strategies for Engineering Controls in Nanomaterial Production and Downstream Handling Processes (NIOSH Pub. 2014-102), National Institute of Occupational Safety & Health, USA.
- Oberdörster, G, Oberdörster, E & Oberdörster, J (2005) Nanotoxicology: An Emerging Discipline Evolving from Studies of Ultrafine Particles. "Environmental Health Perspectives", 113(7).

OECD (2014) Organisation for Economic Cooperation and Development, Research project database, www.oecd.org [accessed 05/01/14].

OECD (Organisation for Economic Cooperation and Development (2014) Database on research into the safety of manufactured nanomaterials, <http://webnet.oecd.org/nanomaterials> [accessed 29/01/14].

RS-RAEng (2004) Nanoscience and nanotechnologies: opportunities and uncertainties, Royal Society & Royal Academy of Engineering.

Scaffold (2014) Innovative strategies, methods and tools for occupational risks management of manufactured nanomaterials (MNMs) in the construction industry, <http://scaffold.eu-vri.eu> [accessed 29/01/14].

WOULD THE TIME-DELAY OF SAFETY DATA MATTER? REAL-TIME ACTIVE SAFETY SYSTEM (RASS) FOR CONSTRUCTION INDUSTRY

Ruwini Edirisinghe⁷⁹, Helen Lingard, Nick Blismas and Ron Wakefield

*¹RMIT University, School of Property, Construction and Project Management, GPO Box 2476,
Melbourne VIC 3001, Australia*

Construction is a safety critical industry. Safety-related indicators can be used as efficient accident/incident precursors. However, delays between indicator data collection and reporting can undermine any possible advantages. The usefulness of indicator data diminishes within a fairly short period due to the dynamism of the construction process. To date, no research has sought to evaluate the efficacy of real-time collection, processing and delivery of safety-relevant data to appropriate persons within a construction safety context.

We argue that it is crucial to monitor predictors of future safety performance levels in real-time. This paper proposes an innovative real-time safety monitoring system for construction health and safety based on a safety indicator framework. The proposed safety monitoring system incorporates project specific indicators as physical hazard indicators, management and perception leading indicators. The system integrates the dynamic nature of the construction site by measuring constructor safety leadership performance through a live on-site data capture mechanism. The system alerts appropriate persons where attention needed based on benchmarked and predicted analysis of safety measures. This enables a step-change in the use and effectiveness of leading indicators in construction safety, with a resultant improvement in workplace safety and health.

Keywords: real-time monitoring, leading indicators frame-work, construction safety performance measure.

INTRODUCTION

Safety critical construction industry

"Throughout the world construction industry is a hazardous industry" (WHSQ 2013: pp 6).

The construction industry records high fatal and or non-fatal accident rates compared to other industries. In Europe more than one in four (26.1 %) fatal accidents at work in 2009 took place within the construction sector (European Commission 2012). In 2012, the USA construction industry reported about one fifth (19.6%) of worker fatalities (OSHA 2013).

Construction-related fatalities in the Australian industry between 2008/9 and 2010/11 equated to 4.26 fatalities per 100,000 workers, which is nearly twice the national fatalities rate of 2.23. Over the same period, the Australian construction industry accounted for 11% of all serious workers' compensation claims, whilst employing 9%

⁷⁹ ruwini.edirisinghe@rmit.edu.au

of the Australian workforce. This accounts for an average of 39 claims each day from employees who required one or more weeks off work because of work-related injury or disease. Also, in 2009–2010, the Australian construction industry recorded the highest number of compensated fatalities accounting to 21% of all compensated fatalities. Unsurprisingly, given this poor record, the Australian Work Health and Safety Strategy 2012-2022 establishes construction as a priority industry for improvement (Safe Work Australia 2012).

Measuring Work Health and Safety performance

Due to the poor safety performance, it is vital to monitor work health and safety (WHS) in the construction sector. Various measures such as lagging indicators, leading indicators and safety climate measures have been suggested in the literature. The limitations of using traditional lagging indicators alone to effectively measure safety performance, has encouraged the use of leading indicators and safety climate surveys to improve safety. Lingard et al. (2013) argue that safety climate models derived from a combination of safety climate surveys, leading and lagging indicators can provide in-depth information about the root causes of WHS problems and these models are considered to be useful diagnostic tools in contrast to using the traditional lagging or leading indicators alone. Safety indicators have been widely debated in the 'safety science' research domain. Hopkin's (2008) critic on the lead-lag distinction in HSE guide (HSE 2006) initiated this debate. Hopkin's arguments such as 'lead or lag is ultimately little consequence' and focus on 'more frequently occurring precursor event' have been criticised (Dyreborg 2009, Grote 2009) in responses. Also, it is argued that understanding of 'causal relationships between indicators and outcome measurements' with respect to a 'time window' (Dyreborg 2009) and 'cause-and-effect relationships' (Grote 2009) are rather significant. Whilst it is not the focus of this paper to review this debate or to argue on the lead, lag or intermediate indicators (Hale 2009) we agree that 'time window' (Dyreborg 2009) or 'time dimension' is vital in analysing causality of events in time sequence (Hale 2009).

In this paper we argue that construction safety monitoring should be done in real-time, enabling up-to-date safety data analysis and reporting to achieve better safety performance. Challenges exist despite the exponential advancements in Information and Communication Technologies (ICT) because the construction industry lags other industries in technology adoption (Ruddock 2006, Hosseini et al. 2012).

BACKGROUND

This section reviews the literature on real-time systems in construction domain. The literature review classified the existing work in to two: real-time information systems and real-time monitoring systems as discussed below.

Real-time Information

Some specific characteristics of the construction industry might be influencing the slow adoption of technology, in particular the use of real-time information systems. The nature of construction projects are such that there are no long-term working relationships beyond the scope of the project. Navon and Sacks (2007) argue that no long-term working relationships in construction projects are one of the reasons that traditional manual processes continue to be used. Further, in construction projects the typical duration of an activity is in the range of days and traditionally the average frequency of reporting is monthly, which also contributes to the absence of real-time

information systems (Navon and Sacks 2007). Navon and Sacks (2007) present the need to move towards Automated Project Performance Controls (APPC) for the construction sector. Three improvements were suggested: (1) monitoring labour is as important as monitoring materials; (2) reports are to be available to subcontractors and suppliers with sufficient frequency and level of detail and (3) more frequent reporting in control systems. Nevertheless, in the recent past, a new vision for construction has emerged as the 'construction site of the future', which has real-time context awareness embedded in construction applications (Carbonari et al. 2011).

The iHelmet (Yeh K. et al. 2012) extends the safety helmet into a real-time information retrieval and projecting device. An iPod and a projector are attached to the safety helmet of a worker in order to retrieve the Building Information Modelling (BIM) information for the worker given that the user location is entered, and the information is projected onto nearby a plane/wall. Recent research on benchmarking safety climate called Automated Safety Climate for Construction (ASCC) suggests that benchmarked quick feedback safety climate data, ideally real-time, gives clients and construction companies the opportunity to rectify any safety issues immediately (Edirisinghe et al. 2014b). In this study the safety climate was analysed at multiple levels, specifically: the client, the principal contractor and across the sub-contractors with the results being reported to the client who would feed these onto the principal contractor. Any safety problems reported immediately to the main contractor were subsequently fed into the feedback loops of sub-contractors to resolve any safety issues in a timely manner.

iHelmet (Yeh K. et al. 2012) and ASCC (Edirisinghe et al. 2014b) are supporting construction sector to embrace the real-time information processing technologies.

Real time tracking/monitoring systems

In addition to the real-time information retrieval solutions discussed above, a number of real-time tracking/monitoring applications have been proposed for the construction industry.

The use of RFID (Radio Frequency Identification) tags in construction is not new. RFIDs have been used in construction sites for tracking tools (M. et al. 2005) and materials (Jeselskis et al. 2003). More recently RFID has been integrated with other technologies, such as 'GPS' to improve blind lifting and loading crane operations (Li et al, 2013) and, 'Zigbee' to track near-miss incidents (Wu et al, 2010). Khoury and Kamat (2009) evaluated three position tracking technologies for user localisation in indoor construction environments: WLAN, Ultra-Wide Band(UWB) and Indoor GPS positioning systems. The proposed indoor GPS system is composed of laser and Infra-Red (IR) light. The precision of each system was evaluated and the technical criteria, logistic issues and cost were discussed. They concluded that the decision on technology should be based on important technical criteria such as calibration and line of sight in addition to other logistic issues such as availability, the prevailing legal situation (e.g. permitted bandwidth) and the associated implementation cost. More recently an UWB based virtual fencing system was proposed to improve WHS on construction sites (Carbonari et al. 2011). This warning system identifies whether predefined danger areas have been accessed by workers. The system was implemented on a construction site at a ground level projection of moving suspended loads. Despite the economic limitations of implementing the UWB system on-site and tagging

workers/assets; the field testing on a loading/unloading area verified the applicability of the system. However, the precision data was not reported.

Ubiquitous location tracking systems to deliver context specific information have been proposed for construction sites using integrated Wireless Local Area Network (WLAN) and Global Positioning System (GPS) as the base technologies (Behzadan et al. 2008). The proposed tracking application can automatically switch between the positioning technologies based on the user's jobsite configurations: indoor or outdoor. Despite the practical limitations of wearing bulky devices by construction workers, the proposed project is a viable approach to deliver context-specific information based on the user's location within the construction site. Pradhananda and Teizer (2013) implemented a GPS-based tracking and analysing system for construction site operations. In addition to the speed analysis of single-system equipment, the system allows proximity analysis of multiple sources which is useful for determining risks on job-sites. Applications would be particularly useful in situations where multiple mobile plants are in operation. WLAN based tagging applications for indoor construction sites were developed and tested by (Woo et al. 2001) on a shield tunnel construction site. The labour tracking application was accurate within 5m of error in which the RFID tag was attached to the safety helmet of the construction worker. More recently labour tracking concepts were extended to monitor productivity (Cheng et al. 2013) and Ergonomics analysis on construction sites (Migliaccio et al. 2013). Cheng et al.(2013) propose a system that analyses workers' task-level activities automatically. The system uses fusion of real time location sensors (RTLS) and thoracic posture data (PSM). Productivity analysis is based on the tagged worker's activities which are coded as material handling, idle and travel on various zones including work zone, storage zone and rest zone. Despite the fact that the experiments were conducted in a controlled environment the technology provides promising potential for the future. Migliaccio et al.(2013) use the same technology combination of RTLS and PSM to analyse the ergonomics of construction workers with a view to detecting unsafe behaviour in materials handling. An innovative device free detection and localisation technique has also been proposed for construction sites (Edirisinghe et al. 2014a). In this study, the Wi-Fi signal processing technique mitigates the multi-path effect caused by moving construction workers, thus enabling the detection of worker presence within hazardous zones.

The monitoring techniques discussed above play a significant role in capturing two types of safety indicators real-time: (1) any accident precursor indicators-the characteristics of the physical work environment (such as the presence and movement of mobile plants, weather conditions and work crew interfaces, risk exposures, etc.) and (2) any safety related events (such as accidents, minor incidents, near misses, etc.). These indicator data types are further discussed in the next sections.

NEED FOR THE REAL-TIME SAFETY DATA FOR CONSTRUCTION INDUSTRY

Accident causation models and safety indicators

Heinrich accident triangle (Heinrich 1931) categorised safety data according to the causal type. The basic concept in the model is that more severe the accident the less there are and that taking care of the smaller accidents or accident components /unsafe conditions will reduce the chance of bigger less frequent accidents (Bellamy 2014). Because, leading indicators are theoretically positioned as antecedents to (rather than

outcomes of) WHS, theories about how WHS is created determine what indicators are chosen (Mohaghegh and Mosleh 2009). However the predictive validity of leading indicators are unknown (Øien et al. 2011). In light of the leading indicator debate on safety science research, studies investigated the causality links. Recently, (Bellamy 2014) examined different hazard bow-ties and concluded that the analysis of accidents can help in addressing major ones proving it is restricted to the same hazard type. This supports the concept of Heinrich accident triangle. Neither the static Heinrich accident triangle nor Bellamy's (2014) study considered the time dimension in analysing causations.

It is essential to consider the time dimension in causality analysis in order to undertake an evaluation of the time-sensitivity of the different types of WHS indicators.

Safety indicator data types for construction industry

The construction accident causality (ConAc) framework (Halsam et al 2003) identifies WHS-relevant factors at three levels: (1) originating influences (e.g. client requirements, design of the permanent works and the prevailing safety culture and risk management approach), (2) shaping factors (e.g. communication, supervision, site constraints, the state of workers' health and fatigue), and (3) immediate circumstances (e.g. suitability, usability and condition of tools and materials, the behaviour, motivation and capabilities of individual workers and features of the physical site environment). While ConAc model is also static, it is one of the few systemic accident causation frameworks developed specifically for the construction industry.

We argue that revealing the time sensitivity of WHS indicators in the dynamic construction project environment is critical. This is important because, without understanding time-sensitivities associated with WHS indicators, an appropriate frequency of useful data capture and reporting cannot be determined. Indeed, there is a risk that valid (i.e., predictive) leading indicators of WHS outcomes might even be dismissed as irrelevant if the lag between data capture and analysis is too great.

The proposed safety indicator framework for construction industry.

Despite the lead-lag indicator debate, we use the terminology 'leading indicators' for the accident precursors including holes in Swiss cheese model. In our interpretation hole is still a precursor with respect to the 'time-window' of a particular accident. Hence regardless of whether it is an output of an input leading indicator we consider the 'hole' as a leading safety indicator.

We identified four types of safety indicators to be measured real-time as follows.

- The occurrence of WHS events, (e.g. accidents, near misses, first aid treatment incidents etc.),
- Physical hazard indicators: characteristics of the physical work environment (i.e. the presence and movement of mobile plant, weather conditions and work crew interfaces). These may include sensor data captured through the real-time monitoring mechanisms discussed earlier, such as GPS, Wi-Fi, RFID, Zigbee or any other technology and or fusion method.
- Management leading indicators : data pertaining to on-going WHS management activity (e.g. the number of safety walks, inspections, training sessions, hazard reports, time to address safety issues arising etc), and

- Perceptions leading indicators: workers' perception data measured periodically (e.g. data reflecting workers perceptions of the quality and effectiveness of the WHS management effort or safety climate data).

Figure 1 depicts these safety performance indicators with respect to the 'time-window' of an accident (assuming causality is already identified which is out of focus of this paper). Perception and management indicator measurement frequencies vary typically from weeks to quarters depending on the practical limitations, resources, etc. These indicators have a limited ability to detect any potential hazards real-time. Hence, we argue that it is vital to monitor physical hazard indicators on-site real-time. However, perception and management indicators enable identification of holes if any. Swiss cheese model indicates the way the holes (which are negative outputs of input leading indicators) intensify during the period from the hazard to the harm. We argue that permitting that in construction industry is dangerous.

We suggest: (1) Using the real-time captured leading indicators as hazard precursors: perception and management indicators, (2) Executing appropriate actions without a delay if holes are identified: this might be based on real-time causality analysis and benchmarked zooming effects at micro level (Hopkins 2008) and (3) Capturing of real-time hazards for immediate actions to avoid the holes being intensified.

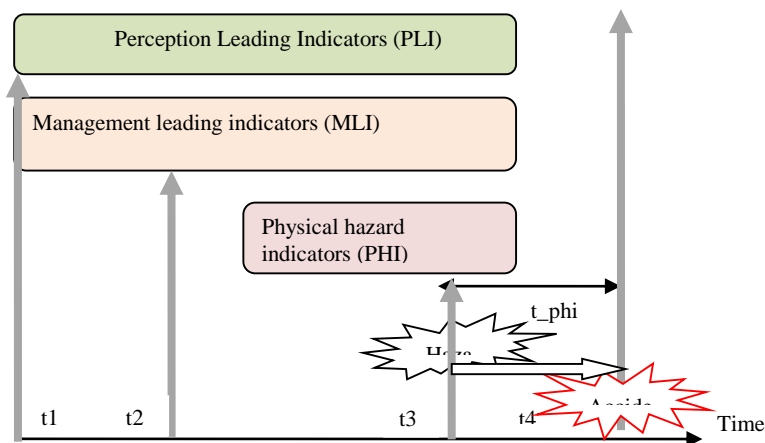

Figure 1. Safety Performance indicators Vs. Time

Leading indicator lifespans

We define the term lifespan as "the time period the indicator remains useful relative to a potential incident". We argue that the usefulness varies according to the type of indicator. Physical hazard indicators have the shortest (t_{phi}) lifespan hence should be collected immediately (real-time) to derive any safety performance evaluations or actions. Management and perception leading indicators have longer lifespans.

We also argue that the usefulness of safety data diminishes with time (Figure 2). Time-delay is the time elapsed between from data collection, through data processing to action on the processed data.

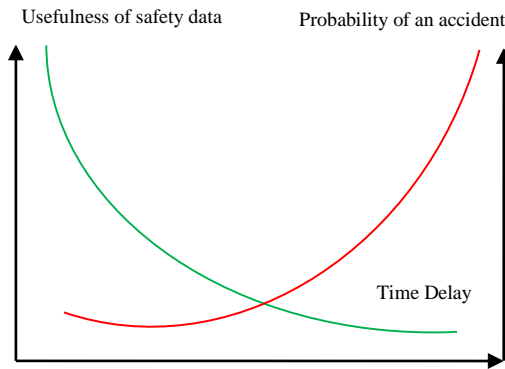

Figure 2. Usefulness of safety data (left-green) and Probability of an incident (right-red) Vs. Time Delay

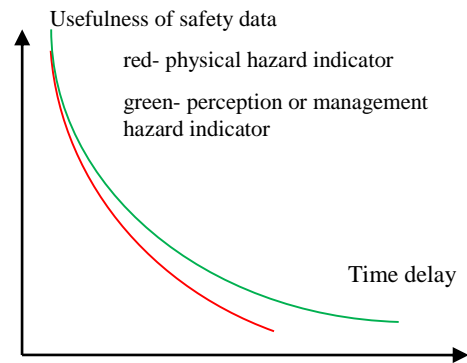

Figure 3. Usefulness of safety data Vs. Time Delay of indicator types

Figure 2 illustrates how increasing time-delays in data processing diminishes the usefulness of the data resulting in a simultaneous increase in the likelihood that a potential hazard or risk will not be detected, increasing the probability that an incident may occur.

It is further speculated that the time-sensitivity of safety data varies according to the life-span attributed the different types of data outlined above. Figure 3 illustrates that the perception or management leading indicators have a lower rate of decrease and the physical hazard indicators have the highest rate of decrease.

Real-time system for safety data

Without the use of advanced technology there is often a significant time-lag between occurrence of change in an indicator and the recording of data reflecting this change. Hence, real-time capture and recording of leading indicators or safety climate is vital due to the dynamism of the construction industry. Regardless of the type of the safety data being collected there is a need for these to be processed immediately in order to undertake an evaluation of the time-sensitivity of the different types of WHS indicators, to enable identifying safety problems immediately and to predict any safety issues proactively. Real-time collection and processing of safety data enables proactive reporting and feedback to the relevant authorities to rectify any hazardous circumstances.

To the best of our knowledge there is no complete real-time system developed to capture, analyse and disseminate work health and safety (WHS) information for construction projects.

REAL-TIME ACTIVE SAFETY SYSTEM (RASS)

We propose a Real-Time Active Safety System (RASS) as a complete system for real-time collecting, analysing and reporting safety data for the construction industry. As depicted in Figure 4, the system is composed of four main modules: (1) Data Acquisition, (2) Analysis, (3) Reporting and Alerting, and (4) Management Actions. These are further discussed below.

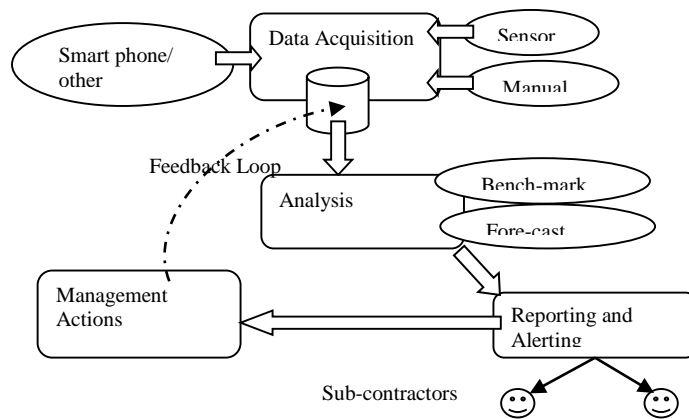

Figure 4. Proposed Real-Time Active Safety System (RASS)

Data Acquisition

The Data Acquisition module captures safety data from various sources and this data is held in a central repository. The sources of safety data could be smart phone or other electronic device such as third party software/hardware, sensors or manual entry.

Examples for data capture through Smart phone/other electronic include any context rich safety information captured by project personnel at a particular site location, safety climate survey data captured from the construction workers (perception leading indicators), frequency and number of safety checks done by contractor safety representative and client's safety representative (management leading indicators).

Sensor data capture applications feed location and any other relevant information to the system. The sensing technology could be RFID, IR, GPS, UWB, Wi-Fi, blue tooth, video camera or any combination. The information about materials, tools, equipment, workers or the site location could be fed into the system. Examples include any hazardous activities or risk exposure captured by the real-time tracking system (physical hazard indicators) and photographic location-based incidents (occurrence of WHS events).

Any safety data entered into the system manually can also be recorded within the central repository. For example, any information captured in hard-copy format can likewise be fetched into the system.

Analysis

The data analysis module of the system will analyse the safety data in real-time. The analysis takes place at multiple levels, such as client, principal contractor and across sub-contractors, at supervisory, co-worker and individual levels. Further, longitudinal analysis is continually undertaken as the project progresses throughout its life cycle. Two types of data analysis would be undertaken, the first being benchmarking. The safety performance would be benchmarked across work groups (Edirisinghe et al. 2014b), projects, organisations and sectors (Lingard et al. 2013). The second type of analysis is forecasting, which would include time series and trend analysis to identify deviations from normal conditions. This would enable the prediction of any potential future risks or safety issues and the rectification of problems before incidents or accidents occur.

Reporting and Alerting

The reporting and alerting module enables reporting to various management and organisational levels of a project and generating alerts where necessary. As Navon and Sacks (2007) highlighted, reporting to subcontractors with sufficient frequency and at sufficient level of detail is vital. The system provides real-time reports to the subcontractors enabling fixing of any safety issues without delay. Management is provided with micro and macro-level reporting. This enables visualising micro-level safety performance of the local site. Macro-level reporting facilitates managers with safety performance data in a multi-site portfolio of projects. These reports could further be available within a quick and easy to access "dashboard" format.

Management Actions

Finally the reporting and alerting mechanism enables and recommends management actions, highlighting any actions that need immediate attention with high priority. Any records of management actions undertaken can be further recorded and fed-back into the central repository to become themselves part of the database of safety data.

RASS vs. the Traditional system

The primary advantage of the RASS is that it consists of an up-to-date central repository of safety information in contrast to the obsolete data/information sitting in a number of unlinked pieces of data sources. Current systems typically have data residing in repositories at numerous distributed administrative units of an organisation such as human resources, engineering, procurement, etc. or within a number of distinct organisations such as clients, consultants, contractors, sub-contractors, and suppliers. This central cohesive linked system avoids any information redundancies, inconsistencies, and improves efficiency in data collection, and more importantly makes up-to-date data available. Traditionally project managers spend considerable amounts of time collecting data from multiple sources before analysing these to compile reports. The proposed system enables automatic reporting without any delay. With the complex analysis (such as causality links) methods available in the system it is possible to generate reports at a number of levels including the sub-contractors.

CONCLUSIONS

Construction is a dangerous industry. In order to prevent accidents, work health and safety (WHS) performance needs to be monitored so that early warning signs of the escalation of WHS risk are identified and can be acted upon. Cause-consequence models and strength & nature of the relationships of leading indicators to the accidents are unknown yet. Also, current methods of monitoring WHS in construction are extremely limited, and may even be flawed. We argue that the safety indicators should be monitored and analysed real-time considering 'time dimension' as a vital element. We propose a safety indicator framework and a real-time active safety system for the construction industry. The future work of this research includes implementation of this proposed system. The future work also includes revealing the time-sensitivity of safety indicators and causality models considering time sequence of events.

REFERENCES

- Behzadan, A. H., A. Z., A. C.J. and K. V.R. (2008). "Ubiquitous Location Tracking for Context-Specific Information Delivery on Construction Sites." *Elsevier Journal of Automation in Construction* 17(6): 737- 748.
- Bellamy, L. J. (2014). "Exploring the relationship between major hazard, fetal and non-fetal accidents through outcomes and causes." *Safety Science* in press.
- Carbonari, A., A. Giretti and B. Naticchia (2011). "A proactive system for real-time safety management in construction sites. ." *Automation in Construction* 20(6): 686–698.
- Cheng, T., J. Teizer, G. C. Migliaccio and U. C. Gatti (2013). "Automated task-level activity analysis through fusion of real time location sensors and worker's thoracic posture data." *Automation in Construction* 29(2013): 24-39.
- Dyrborg, J. (2009). "The causal relation between lead and lag indicators." *Safety Science* 47(2009): 474-475.
- Edirisinghe, R., N. Blismas, H. Lingard, D. Dias and R. Wakefield (2014a). Device free Detection to improve Construction Safety. In proceedings of the CIB W078 Conference on IT in Construction. Florida, USA(Accepted).
- Edirisinghe, R., R. Zhang, H. Lingard and F. Boukamp (2014b). The development of an automated multi-level safety climate benchmarking tool for construction projects. In proceedings of the CIB W099 Conference on Achieving Sustainable Construction Health and Safety, Lund, Sweden. (under Review).
- European Commission (2012).
- Grote, G. (2009). "Response to Andrew Hopkins." *Safety Science*. 47(2009): 478.
- Hale, A. (2009). "Why safety performance indicators? ." *Safety Science* 47(2009): 479-480.
- Heinrich, H. W. (1931). *Industrial Accident Prevention, a scientific Approach*. . New York,, McGraw Hill.
- Hosseini, M. R., N. Chileshe, J. Zuo and B. Baroudi (2012). "Approaches of Implementing ICT Technologies within the Construction Industry." *Australasian Journal of Construction Economics and Building Conference Series* 1(2).
- HSE (2006). *Developing process safety indicators: a step-by-step guide for chemical and major hazard industries*. H. a. S. Executive. Sheffield.
- Khoury, H. M., V. R. Kamat and V. R. Kamat (2009). "Evaluation of position tracking technologies for user localization in indoor construction environments." *Automation in construction* 18(2009): 444–457.
- Lingard, H., R. Wakefield and N. Blismas (2013). "If you cannot measure it, you cannot improve it": Measuring health and safety performance in the construction industry. the 19th Triennial CIB World Building Congress, Queensland University of Technology,, Brisbane, Queensland, Australia.
- M., G. P., M. M.A. and A. Durfee (2005). "The application of active radio frequency identification technology for tool tracking on construction job sites." *Automation in Construction* 15(2006): 292 – 302.
- Migliaccio, G. C., T. Cheng, U. C. Gatti and J. Teizer (2013). *Data Fusion of Real-Time Location Sensing (RTLS) and Physiological Status Monitoring (PSM) for Ergonomics Analysis of Construction Workers*. the 19th Triennial CIB World Building Congress, Brisbane, Queensland, Australia.

- Mohagheh, Z. and A. Mosleh (2009). "measurement techniques for organizational safety causal models: Characterization and suggestions for enhancements,." *Safety Science* 47(1398-1409).
- Navon, R. and R. Sacks (2007). "Assessing research issues in Automated Project Performance control(APPC)." *Automation in construction* 16(2007): 474-484.
- Øien, K., I. B. Utne, R. K. Tinmannsvik and S. Massaiu (2011). "Building safety indicators: Part 2 – Application, practices and results." *Safety Science* 49(162-171).
- OSHA (2013). *Commonly Used Statistics*, United States Department of Labor.
- Pradhananga, N. and J. Teizer (2013). "Automatic spatio-temporal analysis of construction site equipment operations using GPS data." *Automation in Construction* 29(2013): 107–122.
- Ruddock, L. (2006). "Ict In The Construction Sector: Computing The Economic Benefits." *International Journal Of Strategic Property Management* 10: 39-50.
- Safe Work Australia (2012). *key statistics*.
- WHSQ (2013). *Construction Industry Report.*, Workplace Health and Safety Queensland.
- Woo, S., S. Jeong, E. Mok, L. Xia, C. Choi, M. Pyeon and J. Heo (2001). "Application of WiFi-based indoor positioning system for labor tracking at construction sites: A case study in Guangzhou MTR." *Automation in Construction* 20(2011): 3-13.
- Yeh K., M. Tsai and S. Kang, *The iHelmet: An AR-enhanced Wearable Display for BIM Information. Mobile and Pervasive Computing in Construction*, First edition, edited by Anumba C. J. and Wang, X., John Wiley & sons, Ltd. (2012). *The iHelmet: An AR-enhanced Wearable Display for BIM Information. Mobile and Pervasive Computing in Construction*, John Wiley & sons, Ltd.

VIRTUAL CONSTRUCTION SITE SAFETY MONITORING (V-SAM)

Edward J. Jaselskis¹, Michael Behm², Matthew Stimpson³, and Cordelia Nelson⁴

⁸⁰*Jimmy D. Clark Distinguished Professor, North Carolina State University, Department of Civil, Construction, and Environmental Engineering, 224 Mann Hall, Raleigh, NC, 27695-7908*

⁸¹*Associate Professor, East Carolina University, Department of Technology Systems, 231 Slay Hall, Greenville, NC 27858*

⁸²*Director of Assessment, College of Engineering, North Carolina State University*

⁸³*Faculty Support Coordinator, College of Engineering, Campus Box 7547, Raleigh, NC 27695-7547*

A novel approach, Virtual Safety Monitoring (V-SaM), is described to perform construction site safety inspections using streamed video and audio from mobile cameras anywhere on a construction site to safety inspection experts located off-site. The underlying premise of this research is that at least a part of the construction project safety program can be managed remotely and can ultimately result in enhanced job site safety and health performance. A pilot case study on an actual construction project is discussed that demonstrates the promise of using this virtual safety inspection approach. Based on the success of the pilot test, a more rigorous research methodology is described to more scientifically validate this approach. The planned research methodology includes: (1) comparing and measuring the effectiveness of an on-site inspection versus one that involves the V-SaM approach in a controlled laboratory environment, (2) evaluating the V-SaM approach using actual projects to determine its efficacy and utility, (3) further refining and improving the virtual safety inspection protocol to improve its accuracy and applicability to a wide range of construction projects, and (4) disseminating information about this approach. Achieving these specific research objectives and communicating the research results to the construction industry, individual organizations, construction trade organizations, and NIOSH will help to promote practices that lead to a reduction in safety hazards that can cause injuries and fatalities experienced on construction sites. It is anticipated that application of the results of the research in the construction industry will improve worker safety and health performance in the industry.

Keywords: virtual safety inspections, remote monitoring, mobile video cameras

INTRODUCTION

Virtual Safety Monitoring (V-SaM) is a novel approach for performing construction site safety inspections allowing for reduced site-based safety personnel, the ability to obtain expert opinion without physical site presence, and potential to completely

⁸⁰ ejjasels@ncsu.edu

⁸¹ behmm@ecu.edu

⁸² mtstimps@ncsu.edu

⁸³ dede_nelson@ncsu.edu

oversee the safety aspect of a project from a remote location. The idea involves streaming live video and audio from mobile cameras (as opposed to fixed webcams) anywhere on a construction site to team members located off-site. Bonded wireless air card technology is used, permitting sufficient bandwidth, to send high quality video and audio transmissions. Remotely located team members visually instruct and guide the operator of the portable video camera equipment around the site to accomplish their duties in a tele-present or virtual fashion.

Benefits of the V-SaM approach are numerous:

- Addresses several overarching National Occupational Research Agenda (NORA) goals.
- Eases the anticipated shortage of OS&H professionals due to the graying workforce, expected retirements, and employer hiring needs over the next five years (McAdams, et al., 2011). Retired safety inspectors who still want to contribute can do so without the need to be physically present on a construction site.
- Assists in the training of new inspectors by having a virtual expert communicating directly with the new inspector on the jobsite.
- Allows for disabled people to perform safety inspections. The Labor Department recently set new requirements for federal contractors in recruiting and hiring veterans and people with disabilities (ENR, 2013)—this system can provide job opportunities for inspectors who are unable to physically visit construction sites.
- Makes consultation with other virtual experts readily available to the field team.
- Allows for more frequent and/or random inspections leading to greater accountability (Jaselskis, et al., 1996 found that more safety inspections leads to improved safety performance).
- Reduces travel requirements of safety inspectors thus reducing cost and inspector fatigue.
- Transfers readily to other industries such as manufacturing, forestry, and agriculture.

LITERATURE REVIEW

Although not common within the construction industry, tele-presence is a relatively new technology that has been researched in fields such as tele-medicine (The National, 2011; Novartis Foundation, 2012) and tele-engineering for reachback support (ERDC, 2011). Within the construction field, research has been conducted to develop a communication framework based on tele-presence (Anumba, et al., 2000) and perform virtual construction site monitoring using fixed webcams (Silva, et al., 2009; Jaselskis, et al., 2010a). The lead author previously conducted research that shows that it is technically possible to conduct jobsite surveillance from a remote location via a streaming video connection and real time two-way audio (Jaselskis, et al., 2010b). An antenna was mounted on a construction site to create a WiFi interface to the internet; using Adobe Connect video conferencing software and portable video and audio equipment, the lead author was able to stream live broadcasts of the jobsite to students in a classroom 200 miles away, allowing for interactive two-way communication. The virtual project tour concept was also pilot tested using Mifi (personal hotspot) technology on many different projects, including building projects

in Des Moines, Kansas City, and Phoenix; transportation work zones in Iowa; and two projects on the Iowa State University campus (Jaselskis, et al., 2010a; Jaselskis, et al., 2011; Becker, et al., 2012). Video quality ratings of the virtual tour concept were generally lower due to bandwidth fluctuations and signal strength variations from high network demand and physical obstructions (Becker, et al., 2012).

In order to overcome the bandwidth limitations and signal fluctuations symptomatic of using one MiFi device, the first author pursued a new technology which is capable of bonding multiple air cards. A Streamer™ provided by Mushroom Networks expanded the streaming bandwidth and delivered a continuous high-quality video to the users. Several pilot tests were conducted using the Streamer™ to better understand its capabilities. Tests were conducted on housing projects, a student center addition, and bridge and roadway projects. Virtual progress monitoring, training, punchlist preparation, and erosion control inspections were conducted on these projects with positive feedback from participants (Yousif, 2012; Dyayasankar, 2013). A Tele-Engineering and Management (TEAM) Laboratory was developed at North Carolina State University (NC State) to facilitate this testing. This laboratory contains three high-end computers with the necessary software to allow for initial reception and rebroadcasting of the live stream to multiple parties.

CASE DEMONSTRATION OF A VIRTUAL SAFETY INSPECTION

A virtual construction site safety inspection pilot study was performed by the first author as part of the above pilot tests using the Streamer™ on the Talley Student Center remodel and addition project (Dhayasankar, 2013). The main objective of this test was to identify the prospects of using the proposed virtual management idea on a safety inspection and obtain feedback from the safety coordinator to determine the potential benefits and drawbacks. The safety coordinator for the general contractor first performed the virtual inspection with the assistance of a graduate student carrying the video camera and Streamer™; this was followed by the safety coordinator walking the jobsite to observe if any safety infractions were undetected from the virtual inspection. The company safety coordinator was able to verify many safety aspects from his office-site location where he received the live stream from the jobsite, such as workers being properly tied off, handrails installed appropriately, site-made ladders built properly and tied off, and gas cylinders stored appropriately with functional gauges. The portable camera's zoom capabilities made it easier for the inspector to see these issues and increased the distance between the camera operator and the potential infraction. In general, this initial pilot test demonstrated the potential value of the V-SaM approach. More of the details of this pilot test follow.

Virtual Safety Inspection Observations

Personal Protective Equipment (PPE): The safety coordinator was able to see clearly if the workers were tied off with the fall protection system and also determine if they were using their safety harness and other PPE (see Figure 1).

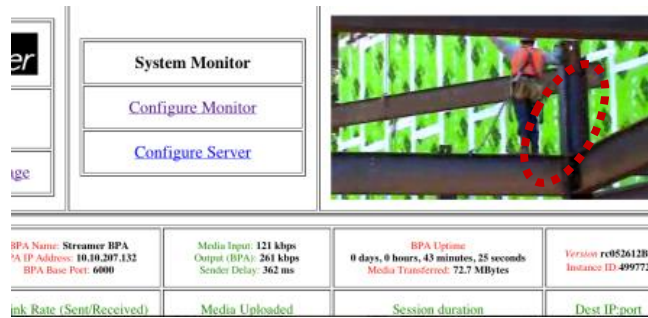

Figure 1. Photograph Showing Worker Properly Tied-off

Handrails: The virtual tour gave sufficient detail to assess if the handrails placed for safety protection on the higher levels were in place. However, one concern was the ability to see smaller detailed items like protruding nails.

Column Bolts on the rebar: The quality on the video was better using the zoom capabilities on the camera, which provided a clearer and larger image of the bolts and the bolt tightening activity.

Gauges: A closer view on the gauges attached to the oxy-acetylene cylinders provided sufficient information to check if they were within the permissible pressure range; another benefit was that the company safety coordinator could make out if the glass panel for the gauge was present and without damage.

Ladders: The job made ladders were to be secured at the top and bottom as per OSHA requirements--the virtual feed could help the company safety coordinator to make out if they were in place as per the standards (refer to Figure 2).

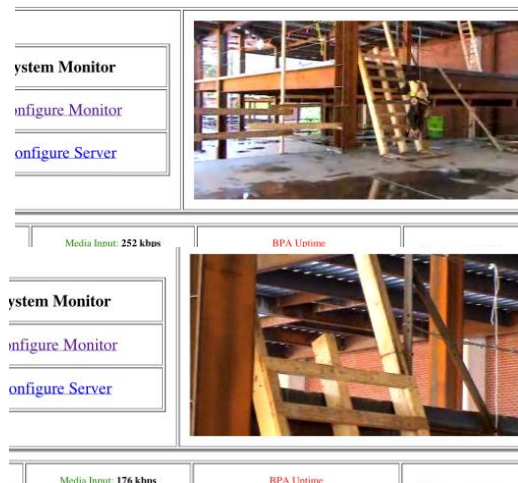

Figure 2. Ability to View Ladder Safety

Rebar bent: The ends of the rebar were to be bent at the edges for protection and the company safety coordinator could satisfactorily view that on the incoming live feed.

Workers Opinion: In general, workers tend to be more cautious if the site inspector is physically present at the site during the inspections. This makes them aware of the fact that they are being watched and tends to put the workers on a more heightened state in regards to the use of good safety procedures. With the virtual approach, workers are viewed in a more natural state.

Time and Cost: The idea of virtual presence at the site can be beneficial especially when stakeholders need to travel long distances amidst their busy schedules.

Challenges

Tunnel Vision: Although the idea of virtual inspection can save time and cost, the tunnel vision through the camera may not be as good as the physical presence of the individual. However, this could be improved by the use of a camera with a wide angle lens.

Familiarity: The idea may be difficult for project participants who access the site virtually for their first time due to lack of familiarity. In such cases, a thorough review of the site plans a head of time will be beneficial.

Ropes: There were ropes lying around in the job site, which could not be viewed by the company safety coordinator when he was viewing the site virtually. This needs to be improved by the attentiveness of the camera operator who needs to know what the virtual participant is looking for.

Concrete Slab: The shadow of the existing Talley center created a problem to the virtual viewers, as they could not make out if an object was water or a shadow. A different angle on the camera could have given a better picture.

Concluding Remarks on the Pilot Test

Overall, it appeared that the virtual safety inspection worked out well for the most part and the safety coordinator could identify what he was looking for. A few more inspections in this area could help determine other possible advantages or requisites for improvement of the proposed idea.

ESTABLISHING THE EFFICACY OF VIRTUAL SAFETY INSPECTIONS

The next portion of this paper describes a proposed research methodology to verify that virtual safety inspections can be just as effective as ones that involve physical presence--with appropriate funding, the authors will be able to perform this portion of the research. The research plan involves using a controlled laboratory setting simulating typical safety issues found on construction projects. This laboratory will make it easier to evaluate the effectiveness of this concept without the distractions and continual changes that normally occur on actual construction sites. Second, the plan includes conducting case studies using the V-SaM approach on at least three actual construction sites and two nonconstruction applications. In both phases, robust data will be collected to support or reject the hypothesis that V-SaM can be just as effective as physical safety inspections. Assuming V-SaM is proven to be an effective means of conducting safety inspections, then the researchers plan to develop a strategy for companies to implement this innovative approach. The third step in the methodology is to disseminate the findings of its efficacy and utility in appropriate conferences, journal publications, and internet media.

Prior to initiating this research project, an advisory panel will be formed to assist in creating a meaningful simulated construction laboratory, identifying safety inspector participants to perform on-site or virtual safety inspections, and providing overall guidance. Four construction safety and health experts will be assembled at the start of this research project. Researchers will utilize guidance on construction safety and health expert panel selection as described by Hallowell and Gambatese (2010). These expert panel members will validate the safety issues developed in the simulated construction site environment and will help in choosing inspection tools and checklists to be utilized during the experimental safety inspections.

Research Questions

Research questions for this exploratory project designed to evaluate the effectiveness of V-SaM are as follows:

- When controlling for age, level of experience, educational background, and certifications, is there a difference in the accuracy of V-SaM compared to traditional site safety and health inspections in laboratory controlled settings?
- Is there a difference in the amount of time spent conducting an inspection via V-SaM and traditional site safety and health inspections?
- How does the use of V-SaM influence the progression (path) of a safety and health inspection?
- How do participants perceive the use of V-SaM to conduct safety and health inspections?
- What are the barriers and incentives to convincing industry management teams and site safety inspection firms to adopt V-SaM?
- What is the best method for training safety inspectors and camera operators on using V-SaM?
- How do site workers, supervisors, and management teams perceive the use of V-SaM prior to its use?
- How do workers, supervisors, and management teams perceive the use of V-SaM after its use?
- How effective do site safety inspectors feel V-SaM is on an active construction site?
- How effective do site safety inspectors feel V-SaM is on active non-construction locations?

In order to answer these research questions, this research project will assess V-SaM in a controlled laboratory environment and on active sites and projects outside of the construction industry.

Phase I – Assessment of V-SaM in a Controlled Laboratory Environment

A laboratory will be created simulating a construction site where both the on-site and virtual inspections are performed and results compared. For the on-site inspections, inspectors will be physically present in the laboratory recording the identified safety issues. Since the virtual inspections will take place with the inspector located in a remote off-site location, a graduate student will operate the mobile portable camera equipment within the laboratory while taking directions from the inspector (such as “move forward about 10 feet and stop”, “zoom in on the worker’s safety harness”, “move the camera to the right”, etc.). The Streamer™ technology used by the first author in previous research will provide high quality video imagery and audio to the virtual inspector.

Task 1: Design and build construction site simulation laboratory

A suitable laboratory space (2,000 to 3,000 SF) will be needed to conduct both virtual and on-site inspections. The advisory panel will assist in ensuring that the laboratory is as realistic as possible in simulating an actual construction site. The plan is to include approximately 25 safety issues typically found on construction sites that involve the inspector’s visual, tactile, auditory, and olfactory senses. A standardized

safety inspection checklist validated by safety experts will be used to record the findings of the safety inspections by both virtual and on-site inspectors.

The research team plans to track the path of the inspectors in the laboratory to help determine metrics such as total path length to accomplish the inspection task and the inspector's proximity to each infraction. Researchers might find that the virtual inspectors do not need to get as close to the safety infraction due to the 20x zoom capabilities on the video camera. Researchers can also study how long it took for each inspector to assess each safety issue. In short, these data will help the research team understand the efficiency characteristics of the virtual versus the physical approach to performing safety inspections. Several positioning system technologies exist to track inspector location and include the following: RFID tags using pervasive WiFi, ultrasonic tags, and ultrawide band tags. After carefully studying our options it was decided to use an ultrawide band indoor positioning system developed by Zebra Technologies—a global leader in asset location and management solutions. The laboratory will be outfitted with a dense network of at least four low-range receivers arranged in a grid pattern. A special RFID tag will be carried by the camera operator (for the virtual tours) and will be placed on the safety inspector during the on-site inspections. It is anticipated that x and y data will be collected every 1-3 seconds from the tag.

Task 2: Obtain participation from construction safety and health professionals

This task involves the selection of construction industry safety and health professionals to provide the virtual and on-site safety inspections in the laboratory. Researchers will ensure that these professionals have sufficient technical knowledge and experience to conduct construction safety audits.

Sample

The study design specifies a single laboratory where safety inspectors will interact through a traditional on-site method or via the V-SaM approach. In order to control for costs and time, two separate samples will be constructed. One sample will be inspectors residing in close proximity to the laboratory and will complete the traditional on-site method of safety inspection. The second sample will be inspectors residing further away and will complete the safety inspection via the virtual safety monitoring approach. Limiting participants in this fashion will reduce costs and increase the likelihood of obtaining participants. The researchers recognize this sampling method has the potential to limit the generalizability of the results. However, the researchers have no reason to suspect that local inspectors are substantively different from counterparts residing in other areas of the country.

Study participants will possess a Construction Health and Safety Technologist (CHST) certification or be a Certified Safety Professional (CSP) or a Safety Trained Supervisor (STS). CSP and STS qualified individuals will also have construction site safety inspection experience. Administrators with the Board of Certified Safety Professionals assisted in estimating population sizes of all three classifications in NC, VA, and the U.S.

Sample Size

The researchers strive for a 10% margin of error and a 95% confidence interval, believing this strikes an appropriate balance between obtaining enough participants to allow for generalization and managing associated costs. Additionally, researchers

estimate the variation in responses to be 50%, allowing for the maximum amount of variation. Using the following equation, we estimate sample sizes for the traditional on-site safety and V-SaM inspection to be 86 and 95 participants, respectively.

(Dillman, p. 206): $N_s = \frac{(Np)(p)(1-p)}{(Np-1)\left(\frac{B}{C}\right)^2 + (p)(1-p)}$ where $N_s =$ sample size, $Np =$

size of population, $p =$ expected variation in responses, $B =$ target sampling error, $C =$ Z statistic with associated confidence level

Sample Selection

Participants will be selected at random for participation in the study. Due to the unequal probabilities of selection between the two samples, we will use sampling weights, allowing for more accurately estimated measures. Individual weights will be specified by (Thomas, Heck, & Bauer, 2005): $W_{ij} = \frac{1}{p_i}$, where $W_{ij} =$ sampling weight of person i in sample j , $p_{ij} =$ probability of selection for person i in sample j .

Task 3: Data Collection

Safety Inspection Performance

The safety inspector participants will complete a detailed construction safety checklist to report their findings. We will develop a preliminary checklist utilizing existing OSHA construction inspection checklists from the South Carolina Department of Labor's office of OSHA Voluntary programs and North Carolina's Department of Labor 2013 publication, A Guide to Construction Jobsite Safety and Health. Our expert advisory panel will review the checklist, and we will modify as recommended. The pared down checklist used for this study will be based on recommendations of the expert advisory group. Care will be taken to ensure that the checklist simulates an authentic workplace situation, in that there will be some items included that do not apply to the specific safety issues in the laboratory setting. The instrument will be designed to request a yes/no response to each listed safety concern.

A response of "no" indicates an area of safety concern. Moreover, inspectors will provide a rationale for the concern. Safety issues will have point values representing difficulty of detection. Point values will be derived with the assistance of the advisory panel. Each inspector will receive a score representing performance on the safety inspection. This score, the Safety Inspection Performance Measure (SIPM), will range in value from 0 to 100.

Geo-spatial Data

An indoor position system will record a participants' path of progression and time spent at each infraction. These data will allow for an understanding of the amount of time participants spend conducting the safety inspection, as well as distance travelled during the inspection. Using these data we will also examine patterns in site safety inspection progression. Using an independent samples t-test, we will examine if there are any statistically significant differences in the amount of time spent conducting the inspection and amount of distance travelled based on inspection method.

Qualitative Data

Participants in the V-SaM sample will complete a follow-up semi-structured interview to gather participant perceptions and opinions of the V-SaM process. We will conduct

interviews either via video conference or by phone, and interviews will be recorded for purposes of transcription.

Demographic and Work History Data

Participants will complete a brief online survey (Qualtrics) prior to conducting the safety inspection and will include: Name, date of birth, contact information, company name, company address, employer/supervisor contact name and address, years working in safety inspection, educational background, and certifications held.

Task 4: Data Analysis

Safety Inspection Performance Measure

Evaluating the efficacy of V-SaM begins by examining mean scores of the SIPM based on inspection method. Using an independent samples t-test, we will examine if there is a statistically significant difference in mean scores of the on-site and V-SaM inspectors. The alpha level will be set to .05, and we will calculate Cohen's D (an effect size measure) for any significant differences. Cohen's D is useful in examining the magnitude of the variation in scores where statistical significance is observed. Using a weighted least squares (WLS) regression, we will examine if SIPM varies significantly by inspection method when controlling for age, level of experience, educational background, time spent conducting inspection, and certifications. Level of experience will be defined as years of experience working in construction and as a site safety inspector and number of site safety projects on which an individual has worked. Educational background represents the level of education of a participant (e.g., high school, some postsecondary education, bachelor's degree, or graduate degree). Certifications include CHST, CSP, and STS training, as well as asking participants to provide other safety inspection relevant certifications held.

The WLS regression model we will fit is: $SIPM_{ij} = b_0 + b_1(age) + b_2(experience) + b_3(education) + b_4(certifications) + b_5(time) + b_6(inspection\ method) + e_{ij}$

Qualitative Data

Using a deductive and inductive approach described by Rossman and Rallis (2012), we will transcribe and then code semi-structured interviews conducted with participants using the V-SaM approach. This process requires that transcripts undergo multiple iterations of coding, to identify the broad categories and themes first, and then narrow themes and findings in subsequent coding iterations. This approach provides researchers an opportunity to glean both macro and micro level findings related to the study phenomenon.

Phase II – Examine the feasibility of implementing V-SaM in industry

In Phase II, we employ a case study approach to study the feasibility of implementing V-SaM in industry and have conceptualized the implementation of V-SaM as having three critical components: adoption of V-SaM by the management team, training site safety inspectors and camera operators on the use of V-SaM, and using V-SaM to conduct site safety inspections. While Phase I focused on the efficacy of V-SaM relative to a traditional site based inspection method, Phase II is concerned with the feasibility of deploying V-SaM on actual construction sites. Additionally, in Phase II we seek to expand the use of V-SaM to areas beyond construction, believing that V-SaM is applicable to safety inspections occurring across industries. The external advisory board members will facilitate selection of appropriate and diverse

occupational sites to test the V-SAM approach for site inspection. Due to space limitations, this phase is not detailed within the proceedings.

CONCLUSIONS

This paper has described an innovative approach to performing construction site safety inspections using streamed video and audio from mobile cameras anywhere on a construction site to safety inspectors located off-site. A pilot test was performed to demonstrate this virtual safety monitoring (V-SaM) approach with promising findings. A subsequent research methodology is described to evaluate the effectiveness and efficacy of the V-SaM method. If proven to be effective, this new safety inspection method can have a significant impact on the construction industry. This novel approach is anticipated to compliment, as opposed to replace, the current on-site safety inspection process.

REFERENCES

- Dillman, D. (2007). *Mail and internet surveys: The tailored design method* (2nd ed.). Hoboken, NJ: John Wiley & Sons, Inc.
- ENR (2013). Contractor groups blast Labor Department contractor regulation. (2013, September 9). *Engineering News Record*, p. 9.
- ERDC (2011). *U.S. Army Engineering Research and Development Center*. Retrieved from http://www.erd.usace.army.mil/pls/erdcpub/www_fact_sheet.capability_page?ps_capability_num=52027&tmp_Main_Topic=&page=BENEFITS&page=TEAM#BENEFIT
- Hallowell, M., & Gambatese, J. (2010). Qualitative research: Application of the Delphi Method to CEM research. *Journal of Construction Engineering and Management*, 136(1), 99-107.
- Jaselskis, E. J., Anderson, S. D., and Russell, J. S. (1996). Strategies for achieving excellence in construction safety performance. *Journal of Construction Engineering and Management*, 122(1), 61-70.
- Jaselskis, E. J., Janaka R., Becker, T., Silva, L., Jewell, P., & Floyd, E. (2011). Innovation in construction engineering education using two applications of internet-based information technology to provide real-time project observations [Special Issue]. *Construction Engineering: Opportunity and Vision for Education, Practice, and Research*, 137(10), 829-835.
- Jaselskis, E. J., Jewell, P., Floyd, E., Jahren, C., & Becker T. (2010a, May). *Virtual construction site field trips using remote classroom technology*. 2010 Construction Research Congress, Calgary, AB.
- Jaselskis, E. J., Ruwanpura, J., Becker, T., Silva, L., Jewell, P., & Floyd, E. (2010b, September). *Innovation in construction engineering education using two applications of internet-based information technology to provide real-time project observations*. NSF Construction Engineering Conference, Blacksburg, VA.
- McAdams, T M., Kerwin, J. J., Olivo, V., & Goksel, H. A. (2011). *National assessment of the occupational safety and health workforce*. Rockville, MD: Westat.
- Novartis Foundation for Sustainable Development (2012). *Telemedicine project in Ghana*. Retrieved from: <http://www.novartisfoundation.org/page/content/index.asp?MenuID=652&ID=1980&Menu=3&Item=44.2>

- Omwiegbizoe, A. J., & Teddlie, C. (2003). A framework for analyzing data in mixed methods research. In A. Tashakkori & C. Teddlie (Eds.), *Handbook of mixed methods in social & behavioral research* (pp. 351-384). Thousand Oaks, CA: Sage Publications.
- Rossmann, G. B. & Rallis, S. F. (2012). *Learning in the field: An introduction to qualitative research*. Thousand Oaks, CA: Sage Publications.
- Silva, L. P., Ruwanpura, J. Y., & Hewage, K. N. (2009). *Virtual supervision in construction projects*. Proceedings of the ASCE 2009 Construction Research Congress, Seattle, Washington, 487–496.
- The National (2011). *Telemedicine Center offers Dubai patients virtual consultations*. Retrieved from <http://www.thenational.ae/news/uae-news/health/telemedicine-centre-offers-dubai-patients-virtual-consultations>
- Thomas, S. L., Heck, R. H., & Bauer, K. W. (2005). Weighting and adjusting for design effects in secondary data analysis. In P. D. Umbach (Ed.), *Survey Research Emerging Issues*. New Directions for Institutional Research, No. 27, (pp. 51 – 72). San Francisco: Jossey-Bass.
- Yousif, A. (2012) Real-time monitoring of construction site operations using virtual project management techniques. Unpublished master's thesis, North Carolina State University.

SAFETY ASPECT IN CONSTRUCTABILITY ANALYSIS WITH BIM

Kristiina Sulankivi ⁸⁴, Matti Tauriainen ², and Markku Kiviniemi ¹

¹ *VTT Technical Research Centre of Finland, B.O. Box 1300, Tampere, Finland*

² *Aalto University, School of Engineering, Department of Civil and Structural Engineering,
P.O. Box 12100, Espoo, Finland*

Constructability assessment and safety planning is mostly based on 2D-drawings and other paper documents, but use of BIM (Building Information Modelling) for both of these are increasing trends. The purpose of this paper is to describe the most promising possibilities of using BIM in improving both constructability review and safety planning processes, and to clarify the relationship of constructability and safety. The paper is a result of analysis made related to previous work carried out by two research teams, one focusing previously on developing BIM-based safety planning, and the other one clarifying the concept of constructability and possibilities of BIM, as well as developing BIM-based constructability review process and co-operation between designers and contractors. Using the new approach the common targets and means of using BIM for safety or constructability purposes were identified, as well as common development needs and possibilities in order to use models more efficiently in the future. Construction safety has been found to be one attribute of constructability, safety of precast concrete frame assembly being one of the most important issues. A common hypothesis is that BIM can be used to promote site safety improving also constructability, and vice versa. BIM can be used for design, planning and review purposes carried out by one party, but also to measure constructability and to support team work between design and construction parties. BIM enables visualization of schedule including installation of permanent building parts and temporary safety arrangements before the real construction process. The results provide information to the building construction industry about the possibilities of BIM in promoting both constructability and safety, and as a result improving and streamlining the site processes especially in the frame construction phase.

Keywords: Buildability, Building Information Modelling, Construction Safety, Constructability.

INTRODUCTION

Previous research abroad have established a direct association of constructability with lowering cost and time, increasing quality and safety, and reducing amount of changes in construction projects (RYM Oy 2014a). In Finland, the concept of constructability is not well known, and as a result, not either the relationship of safety and constructability. Additionally, the main method for evaluating constructability in building construction projects is still visual review of the drawings, even Building Information Modelling (BIM) provides possibility to develop more systematic, detailed, and concrete methods for evaluating and improving constructability. One of

⁸⁴ Kristiina.Sulankivi@vtt.fi

the first steps toward use of BIM is taken by Aalto University in their research concerning possibilities of BIM as intensifying technology to improve constructability (Tauriainen et. al. 2012). In their research, attributes of constructability were studied, and occupational site safety was found to be one of the most important factors.

Occupational site safety has been identified to remain a worldwide problem and BIM found to be potential tool for promoting it. Possibilities of BIM for safety purposes has been studied during recent years from different kind of perspectives. For example, purely from the viewpoint of safety planning in construction planning phase by e.g. VTT Technical Research Centre of Finland and Georgia Tech US, and from the viewpoint of possibilities of taking safety into consideration already in the design phase by e.g. Philadelphia University and California State University US, and University of Reading UK. According to Kasirossafar & Shahbodaghlou (2012) BIM-based visualization tools have more positive effects on improving construction safety in comparison to the other current tools for design for safety concept (DfS).

A natural step forward is to broaden the scope and investigate possibilities of BIM to improve both safety and constructability considering them alongside. Limiting examination to purely safety planning or purely constructability of design solutions, for instance, does not bring full potential to eliminate problems proactively. Correlation between constructability and safety and BIM is ignored in previous research, and this study aims to fill this gap by clarifying the relationship of constructability and safety in general, and by describing the most promising possibilities of using BIM in improving both of them, as well as by highlighting some prerequisites for modelling process to be able to advantage BIM more efficiently in the future.

PREVIOUS RESEARCH

Constructability is an approach that links the design and construction processes. The concept of constructability (buildability in United Kingdom) emerged in the late 1970's, and evolved from studies into how improvements can be achieved to increase cost efficiency and quality in the construction industry. The concept optimized the use of construction knowledge and experience in project planning, design, engineering, procurement, and construction to achieve overall objectives.

Constructability concepts and attributes or key factors are categorized in several studies (Adams 1989, Fischer & Tatum, 1997, Pulaski & Horman, 2005, Tabesh & Staub-French, 2006, Wong et al. 2006, Mydin et al. 2011) and guides (CIIA 1996, CII 2006). Typically the categorization of attributes is organized in conceptual planning, design and procurement and site operation stages. Construction safety issues are often included in the key factors at the design stage. According to the constructability concepts of Construction Industry Institute (CII), it is important to secure and enable an effective and safe project progress during construction and examine opportunities that can lead to safer site and work processes. Safety attributes mentioned by Wong et al (2006), for example, are the designing of: safe construction below ground, visualization of finished work, temporary equipment anchorages in permanent structures, sizes and weights of material are safe for workers to handle using commonly available equipment, allowing sufficient working space, enabling efficient site layout, storage and access, and allowing flexibility in erection works.

According to Grilo & Jardim-Goncalves (2009) 3D models facilitate the study of alternative design solutions through the improved ability to visualize design proposals in the early stage of project and make the assessment of spaces and structures. The growing implementation of BIM in construction industry is changing the procedures of safety planning and analysis. Virtual Design and Construction (VDC) simulate various stages of the construction process and help designers and contractors visualize and resolve the schedule of works, risks and safety hazards prior to the problematic conditions arise in the project. (Zhang et.al. 2012). On the whole, the previous research experience in utilizing BIM for safety include: 1) BIM-based site layout plans and crane reach visualizations related to lifting work and risk of crane collapse 2) visualization of demolition work procedures and sequences 3) modelling of e.g. safety railings and floor covers into a BIM-based fall protection plan 4) 4D-visualization of workflow including safety aspect, such as precast concrete frame construction, or floor form work together with needed fall prevention solution 5) expert analyses with the aid of virtualised construction site 6) automatic safety analysis using BIM technologies, and 7) site safety communication with help of BIM (Kiviniemi et.al. 2011), as well as 8) testing automated fall protection planning (Sulankivi et. al. 2013). Additionally, research and test trials has been carried out bringing designers and builders together to promote active discussion and engagement with safety issues using detailed digital design models and 3D stereo displays in a digital laboratory (Whyte et. al. 2013).

RESEARCH METHOD

Results are based on cooperative analyses of two research teams concerning relationship of BIM-based safety planning and BIM-based constructability review processes, as well as potential of BIM to support both of these more efficiently. For this analysis, a lot of previous experience and knowledge has been advantaged including information found in literature, numerous interviews, and several previous case studies carried out mainly 2011-2013 concerning the constructability study, and 2008-2013 related to utilization of BIM for improving site safety. To get an insight into the comprehension of constructability of Finnish building and construction professionals (architects, structural and building services designers, building contractors' site and line managers, engineered-to-order and building material producers, and other professionals and researchers) at the total of 45 semi-structured and structured interviews had been carried out by the other research group. In the case studies the industry representatives has been involved, which has provided change to collect ideas and feedback as well, especially concerning the most useful ways of using BIM for special purposes of safety and constructability.

RESULTS

Safety - an attribute of Constructability

Interviewed designers described constructability as a process to discover, together with other project parties, that the project can be executed according to the design solutions. The drawings must be prepared so that the design solutions can be built without interruptions, fast and effectively. Contractors' site and line managers described constructability as the efficiency of construction work. Engineered-to-order (ETO) producers, as a steel fabricator and prefabricated concrete producer, described constructability through the cost efficiency of product fabrication.

Attributes affecting constructability can be categorized in eight groups, which are: building economy; building process management; design solutions; BIMs, drawings and specifications; standardization and prefabrication; assemblies; construction works; and health and safety. On site, construction health and safety is considered as an important constructability factor. The communication of safety plans for subcontractors and site workers is under the responsibility of the main contractor. Relating to BIM-based safety planning, designers should be informed as early as possible about the aim to use BIM for safety purposes, and the process to produce the safety model should be organized properly. On site, safety documents including lifting plan and instructions, and fall protection plan, as well as site layout plan are obligatory. Until recently, the documents have been the combination of written instructions and 2D drawings. According to the interviews, the communication of safety plans for subcontractors and workers is challenging, and in some cases it was stated that the visual nature of BIM helped to analyse safety issues on site.

Structural and building service designing have critical roles performing good constructability and safety. The designing work should be carried out so that the flexibility of changes of building materials and systems in the procurement phase is still possible. The requirements of construction work should be taken care and visualized both in the building information models and in drawings. Clashes between structures and building service systems and the differences between the contents of models and drawings should be minimized. The models should be prepared so that use of them in the procurement and construction phase is made possible for contractors and material providers, when special production models based on structural and building service models are to be used for the analyses and simulations related to scheduling, site logistics and construction safety.

In the interviews it was stated repeatedly that the importance of construction safety has increased significantly recently. In structural design, the safety of a structural framework was taken care of both in design of the main load bearing systems and in precast detailing, as well as in structural assembly and safety plans. The assembly plan of frameworks must be carefully prepared including safe assembly schedule, the safety of the lifting of elements and the arrangements of temporary scaffoldings and assembly studs. Also the details for safety railings and fall protection must be designed as well as demolition works, and the use of materials and substances, which are harmful to health and the environment. In the prefabricated elements lifting anchors and anchors for temporary studs and safety equipment must be designed. Building service designers take care of the design of fall protection in the vertical service system shafts and the horizontal installations at high in the room space.

Most promising ways of using BIM for improving Safety and Constructability

The most promising opportunities identified for using BIM to promote both safety and constructability are listed in Table 1. Part of these possibilities is already being used by the leading companies. Some of them have been tested in e.g. research projects and they are in use by few contractors only. The rest has been found to be potential based on the research, but needs pilot testing, or are to be developed further before they can be used by the industry. Maturity of each use case of BIM is evaluated and listed in the table.

Table 1: Use of BIM in promoting safety and constructability.

Means of using BIM	Maturity	Examples of utilization
1. Visual examination of BIM	In use	<ul style="list-style-type: none"> - Viewing architectural model - Viewing structural and MEP model before/while construction planning - Viewing details (if modelled) on site from the structural model
2. Clash detection using combined model	In use	<ul style="list-style-type: none"> - Eliminating clashes between MEP and structural parts
3. BIM-based construction planning	Limited use in leading companies, under development	<ul style="list-style-type: none"> - 3D site layout planning - Fall protection planning - 4D scheduling of permanent building parts (safety usually not included in practice) - Automated BIM-based safety planning
4. Visualization in 3D or 4D	Limited use in leading companies, under development	<ul style="list-style-type: none"> - Static 3D visualizations (of e.g. planned safety solutions) for use in communication with client, site workers and safety authorities - Dynamic 4D visualizations of planned construction workflow / site status on specific date
5. BIM as a tool for co-operation	Under development (Case studies/ test trials have been carried out)	<ul style="list-style-type: none"> - BIM supporting discussions between e.g. contractor, structural and MEP engineer, target being in improving safety and constructability
6. BIM-based checking, analysis, appraisal and measurement of safety or constructability	Under development (Case studies/ test trials have been carried out)	<ul style="list-style-type: none"> - Constructability assessment or review, based on structural model - Automated safety checking

1. Visual examination of BIM

First, BIM can be used for visual examination of constructability, without any specific tool, but just using previous professional experience. This has been done previously by reviewing 2D-drawings and other design documents, but visual nature of BIM can facilitate this task remarkable. Viewing a 3D architectural model gives a general understanding of the complexity of the building, and construction professionals may identify certain special features in design causing constructability risks (e.g. inadequate space reservations for MEP systems). Safety professionals, in turn, may identify safety risks as a result of complex structures in high level, for instance. However, the structural model of the project describes the real construction assemblies, parts, and details, and provides the most important bases for BIM-based constructability review. Relevant issues to review in a structural BIM are dimensions of frame elements and assemblies, connections between parts, size and position of openings, and unusual structures, for instance. They all have influence on the complexity of the construction work at site, and occupational safety of the work. As an example of benefit of BIM and virtual environment, Whyte et. al. (2013) described a case where experienced safety professionals identified, that using prefabricated

building components would reduce or eliminate the hazards to workers that would be posed by working at height to form and pour cast-in-place concrete components.

2. Clash detection using combined model

One basic prerequisite for good constructability is correct and accurate design solutions in 2D structural drawings (Tauriainen et. al. 2012). In BIM-based structural engineering this means, that there aren't errors in the model from which the drawings also are produced. The most common way to eliminate errors is to combine models of various design disciplines in IFC file format and carry out semi-automatic clash detection for eliminating conflicts between e.g. various structural parts and HVAC design. The key issue and benefit from clash detection is that as a result of careful checking most of the problems related to design errors can be eliminated before the real work on site. As a result, there are fewer disruptions on construction site and less ad-hoc decisions and solutions, which are known to increase safety hazards beside e.g. time schedule problems.

3. BIM-based construction planning

BIM-based construction sequence planning means that building elements and assemblies of the structural model are connected with corresponding construction tasks. Additionally, the order and timing of these tasks are defined, bringing us to BIM-based 4D planning, which is carried out by leading contractors. Constructability and safety can be improved in frame construction phase by this kind of BIM-based pre-planning. However, currently it's not common to include safety in 4D, even the selected fall protection solution has influence in frame constructability. It's important to include both the permanent building parts and the needed temporary safety structures/equipment in the same model to maximize the potential of BIM to promote safety and constructability in the future. An example of this is presented in figure 1.

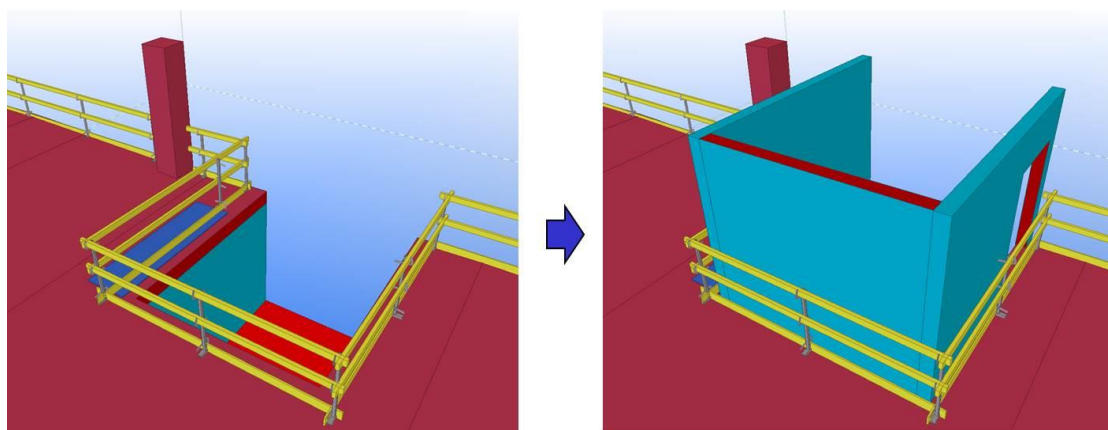

Figure 1: Example of BIM-based fall protection planning supporting constructability.

In this case, the modelled railing type was selected and position planned far enough from the slab edge, to leave room for installation of the precast wall panels and to avoid removing the guardrail until the wall panels have been installed and risk of fall from height eliminated (BIM Safety project 2011).

4D-BIM makes it also possible to develop automated safety checking and planning such as fall protection planning. This kind of prototype solution has been developed and described by Georgia Tech (Zhang et. al. 2011) and tested in a real project (Sulankivi et. al. 2013). That tool is not available for contractors yet, but as the final

goal it is considered, that with help of BIM-based tools the safety planning is part of the standard building construction planning process in the future (RYM Oy 2014b).

4. Visualization in 3D or 4D

Visualizations which can be produced from BIM as a static 3D views or 4D construction status visualizations can both be used for supporting safety and construction work related communication. By a 3D model view one can visually present the aimed design solution, safety solution to be used, or connections between structural parts etc. From the viewpoint of safety, 4D means a possibility to present needed safety protection in certain moments of time together with the building parts permanently installed to the building as in Figure 2.

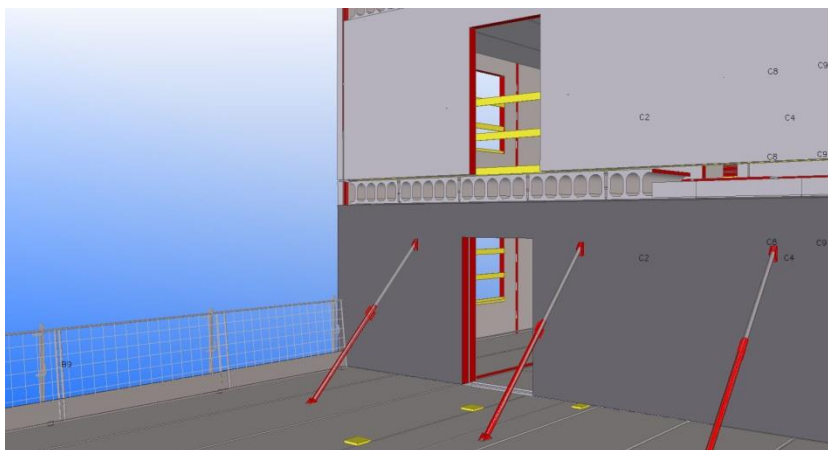

Figure2: Demonstration of 4D planning including safety.

5. BIM as a tool for co-operation related to safety and constructability

Interviewed industry practitioners found the development of constructability by means of collaboration between e.g. designers and building contractors problematic. Several issues arose including design and construction agreement types, contractors' defective participation to manage and control constructability objectives in the early design stage, the timing of the inspection and assessment of drawings and building information models, tight design time schedule from designers' point of view, and the lack of the constructability assessment method. On the other hand the use of BIM in design and modelling meetings between designers and contractor site and line managers was found to visualize constructability issues better than the use of drawings only, and "BIM-based constructability assessment" is suggested to be included in the agenda of these meetings. Whyte et. al. (2013), in turn, found the relationship between safety and design complex, but found models to facilitate conversations between builders and designers. However, they identified the need to carefully build rich models that direct attention to relevant aspects, as well as to allow professionals to probe and discover further contextual information about the project, and to see it within the context of the site and the construction process.

6. BIM-based checking, analysis, appraisal and measurement of safety or constructability

From the viewpoint of constructability and occupational site safety, BIM-based checking and analysis may mean a lot more than just clash detection. In the research work carried out by Aalto University a BIM-based constructability assessment methods were piloted (RYM Oy 2014a). A BIM-based tool for calculating a numeric value for constructability, the constructability score, was developed. The assessment

method was simulated and constructability score calculated in seven cases by the researchers. The results support the assumption about the assessment method being applicable in the BIM-based constructability analysis of structural frames. At the same time a visual analysis is needed particularly for an architectural and building service models. In the test cases also early design development stage architectural models were used and seen applicable for the calculation of constructability score, but at the moment, building service models can be analysed only visually. In the future, clash checking tools could be used after development of rules for constructability assessment.

Development needs and proposals related to modelling and BIM-based workflow

In general, building information models are currently utilized mainly to create drawings, and the potential of model itself is not properly utilized. Focus should be transferred from drawings to the model, which provides a lot of new opportunities in form of visual reviews and data sheets, for example.

Based on the interviews and test trials in case building projects, there are problems related to modelling procedures, which should be solved before it's possible to take full advantage of BIM for constructability and safety purposes. Constructability of structural elements could be analysed visually and analytically complete in design phase using BIM if: 1) naming and identification of elements were completed 2) material qualifications of elements were correct 3) reinforcements of main structural in-situ and prefabricated concrete elements were modelled, and 4) clashes between main structural elements and MEP systems were eliminated. In construction phase, constructability of structural elements could be analysed visually using BIM if: 1) site conditions including logistics areas were modelled 2) element connections and joints were modelled 3) assembly and fitting parts were modelled, and 4) construction schedule was visualized.

There is still need for a deeper co-operation between designers' and contractors' personnel under the area of constructability on the whole. A procedure to manage and control constructability during design and construction stages should be established. A manager in the charge of constructability issues should be nominated. Constructability assessment should be carried out systematically both in design and construction stages by designers and contractors or other constructability professionals. In the assessment, models, drawings and other building specifications should be used.

Especially from the viewpoint of safety, current weakness is that temporary safety equipment and structures are not usually modelled. They should be included in BIM-based 4D construction planning, as well as in various constructability analysis and visualization to advantage the possibilities of BIM to promote safety planning, and as a result constructability as well. However, the interviews stated, that the use of modelling tools and their safety components were experienced complex and time consuming. The process between designers and contractors to produce the safety model should also be organized properly. Additionally, BIM-based structural modelling and construction work scheduling both should be carried out in more detailed level than they are usually made today. For example, details are usually still described in 2D-drawings, even they are important if considering constructability.

There is also needs and new possibilities for software development to better support use of BIM for safety and constructability purposes. For example, there are not much ready modelled 3D safety components/objects publicly available, and there are not

developed tools to manage temporary safety equipment parallel with the permanent building assemblies. However, it seems quite obvious, that the tools will develop to the desired direction and towards more dynamic virtual construction planning tools, taking advantage from e.g. game technology for evaluating construction installations.

CONCLUSIONS

The concept of constructability has been common research subject but constructability analysis with BIM is a fairly new approach and it allows new evaluation methods to be used. Construction safety is one attribute of constructability, and the importance of safety has increased significantly recently. Especially on site, construction health and safety is considered as an important constructability factor, and BIM has found to be useful in analyzing safety issues and in communicating them to site staff. As a result, the construction work can be conducted more efficiently and without interruptions, which correlates with good constructability.

As a result of considering possibilities of BIM for safety and constructability alongside, all together six different promising methods were identified for using BIM for promoting both. The same basic BIM-based examination methods of a model can be used for safety analyses and analysing other constructability factors, such as design solutions. Visual examination of models is the most obvious and currently the most used method in practice. Also special clash detections using combined model is used. Besides checking geometric clashes, special rules could be developed to check some safety issues and different kind of rules to check or measure special constructability issues such as number of different type of connections. BIM-based construction planning, especially sequence planning and work task scheduling, and various 3D and 4D visualizations have also found to be promising ways of using BIM to promote safety planning improving also constructability. With help of 3D model the work order at site can be evaluated in more detailed level and safety issues, such as fall protection and site layout are important in this evaluation. These plans are obligatory in Finland, but more importantly, use of BIM has been found useful for these purposes improving safety and streamlining the site processes. Additionally, there are new possibilities to use BIM as a tool for co-operation. BIM can promote understanding of various project parties concerning the aimed design solutions and construction procedures to be used, as well as viewpoints of safety and constructability in both of these. However, some hindrances exist in taking BIM into use for promoting co-operation in safety and constructability purposes. These include organizing the safety modelling process between structural engineers and contractors better, for instance.

Use of BIM for analysing and optimising construction work at site has started, but is still used pretty much in the same way as 2D-documents have been used, just adding use of 3D viewing possibility to the traditional procedures. BIM should be used more efficiently, but it should contain more intelligence than it does today to be able to make different analysis easier and even automatically.

Nowadays, the common modelling tools are intended for design work and for combining or comparing static models. Tools are not dynamic to analyse component level work flows and are also unable to manage virtual construction work at detailed level. On the other hand, some major issues affecting safety on site are determined in early design phases while e.g. selecting the structural system or splitting a wall to precast panels. BIM tools or analysis methods could, for example, guide the designer

automatically make a safety and constructability analysis for the existing alternatives before making decisions on design solutions to be developed further.

REFERENCES

- Adams, S. (1989). *Practical Buildability*. Construction Industry Research and Information Association (CIRIA)/Butterworth, London. 121 p.
- Construction Industry Institute (CII). 2006. *Constructability Implementation Guide*. University of Texas at Austin. Special Publication 34-1, 2nd Edition.
- Construction Industry Institute, Australia (CIIA). 1996. *Constructability Manual*. Special Publication 1. 2nd Edition.
- Fischer, M. & Tatum C.B. (1997). Characteristics of Design-Relevant Constructability Knowledge. *Journal of Construction Engineering and Management*, 123(3), 253-260.
- Grilo, A. & Jardim-Goncalves, R. 2010. Value proposition of interoperability on BIM and collaborative working environments. *Automation in Construction* 19, 522-530.
- Kiviniemi, M., Sulankivi, K., Kähkönen, K., Mäkelä, T. & Merivirta, M.-L. (2011). BIM-based Safety Management and Communication for Building Construction. VTT Research Notes 2597. VTT, Espoo 2011. 123 p. Available on-line <http://www.vtt.fi/inf/pdf/tiedotteet/2011/T2597.pdf>
- Mydin, S.H., Zin, R.M., Majid, M.Z.A., Zahidi, M. & Memon. A.H. (2011). Buildability Attributes at Design Phase in Malaysian Building Construction. *International Journal of Sustainable Construction Engineering & Technology*, 2(1), 24-43.
- Pulaski, M.H. & Horman, M.J. (2005). Organizing Constructability Knowledge for Design. *Journal of Construction Engineering and Management*, 131(8), 911-919.
- RYM Oy (January 2014a). BIM boosts buildability [Online]. Available: <http://rym.fi/results/bim-boosts-buildability/> [last visit April 11 2014].
- RYM Oy (January 2014b). BIM-based Automated Safety Checking and planning [Online]. Available: <http://rym.fi/results/bim-based-automated-safety-checking-and-planning/>
- Sulankivi, K., Zhang, S., Teizer, J., Eastman, C.M., Kiviniemi, M., Romo, I. & Granholm, L. (2013). Utilization of BIM-based Automated Safety Checking in Construction Planning. In: Kajewski, S., Manley, K. & Hampson, K. (Eds.) *Proceedings of the 19th International CIB World Building Congress, Brisbane Australia 5–9 May 2013*. Queensland University of Technology.
- Sulankivi, K. & Kiviniemi, M. 2011. BIM Safety research project results. http://www.vtt.fi/files/sites/bimsafety/bim_safety_falling_prevention_planning_pilot1.pdf
- Tabesh A.R. & Staub-French S. (2006). Modeling and coordinating building systems in three dimensions: a case study. *Canadian Journal of Civil Engineering*, 33, 1490-1504.
- Tauriainen, M., Mero, A-K., Lemström A., Puttonen, J. & Saari, A. (2012). The development of constructability using BIM as an intensifying technology. In: Gudnason G., & Scherer R. (Eds.) *eWork and eBusiness in Architecture, Engineering and Construction. Proceedings of the European Conference on Product and Process Modeling 2012, Reykjavik, Iceland, 25-27 July 2012*. CRC Press/Balkema, Taylor & Francis Group, London, UK.
- Wong, F., Lam, P., Chan, E. & Wong, F. (2006). Factors affecting buildability of buildings designs. *Canadian Journal of Civil Engineering*, 33, 795-806.

- Zhang, S., Lee, J.-K., Venugopal, M., Teizer, J., Eastman, C. (2011). Integrating BIM and safety: An automated rule-based checking system for safety planning and simulation. Proceedings of the CIB W099 Conference 2011, Prevention: Means to the end of injuries, illnesses, and fatalities, Washington D.C., USA, August 24–26, 2011.
- Zhang, S., Teizer, J., Lee, J.-K., Eastman, C. & Venugopal, M. (2012). Building Information Modeling (BIM) and Safety: Automatic Safety Checking of Construction Models and Schedules. *Automation in Construction* 29, 183-195.

FORMALIZING CONSTRUCTION SAFETY KNOWLEDGE FOR INTELLIGENT BIM-BASED REVIEW OF DESIGN FOR SAFETY

T.Q. Nguyen⁸⁵, Ernest L.S. Abbott⁸⁶, David K.H. Chua⁸⁷, and Y. M. Goh⁸⁸

^{1, 2, 3} Department of Civil and Environmental Engineering, Faculty of Civil Engineering, National University of Singapore, 1 Engineering Drive 2, Singapore 117576

⁴Department of Building, School of Design and Environment, National University of Singapore, 10 Kent Ridge Crescent, Singapore 119260

Work place accidents in the building industry are amongst the highest of any industry. Often it is the design of the building that can militate against a safe working environment during construction and maintenance. As many as 60% of construction site accidents could have been avoided, reduced or even eliminated if more consideration has been given to design. This paper addresses risk at design source by developing a systematic method for formalizing safety knowledge for intelligent BIM-based review of design for safety. It involves a comprehensive hierarchical taxonomy structure for building a safety knowledge library and the design rules necessary for preventing safety risks. The proposed structure serves as the foundation for an automatic safety validation system using Building Information Model (BIM) to provide computer-aided intelligent review of building plans for construction and maintenance hazards related to deficient design. The system manages the control of the hazards identified so that design features can be added to mitigate the risks. Its key functionalities are demonstrated through an illustrative example based on a middle-scale clinic building project. The system facilitates a 3D/4D view of the risk and its control so that designers and constructors are better able to evaluate the associated risk.

Keywords: BIM-based safe design, construction safety, design for safety, safety knowledge.

INTRODUCTION

Safety is a major concern for the construction industry. The industry has, relative to manufacturing, a far worse safety record, with about twice as many fatalities. In the past, efforts have been directed towards reducing accidents during the construction phase of a project, as it was considered that safety was sole responsibility of the constructor. However, there is a growing realization that many hazards during construction, maintenance and repair can be eliminated or, at least, mitigated through careful consideration in design. In a recent study (Behm 2005), 42% of 230 construction fatality cases sampled from the database of National Institute for

⁸⁵ ceentq@nus.edu.sg

⁸⁶ ceeael@nus.edu.sg

⁸⁷ ceedavid@nus.edu.sg

⁸⁸ bdggym@nus.edu.sg

Occupational Safety and Health were found to be linked to design. Modifications to the design or design process could have reduced the safety hazard or altogether avoided the incident. Other surveys and analyses of construction site accidents have indicated that as many as 60% of them could have been avoided, reduced or even eliminated if there had been more thought during the design stage of the project (Lorent et al. 1991). Similarly conclusions have been arrived at by other researchers (Gibb et al. 2004; Hecker et al. 2004a; Hecker et al. 2004b).

The use of software tools for implementing the design for construction safety knowledge has grown rapidly in recent times. The Construction Industry Institute (CII) has developed a software program, titled “Design for Construction Safety ToolBox” to assist designers to identify and eliminate safety hazards, and provide various suggestions to improve the safety aspects (Gambatese et al. 1997). ToolBox is a standalone program. It is akin to a library of knowledge to which designers have access enabling them to search for safety suggestions for hazards they have identified in their design. The shortcoming with this is that it relies upon the designer to identify a hazard. If the designer is not able to identify a hazard it would not be eliminated. The designers would have to gain more safety knowledge and experience, in order to have a more comprehensive understanding of hazard identification. Cooke et al. (2008) developed a web-based tool called ToolSHed used in helping assess the risk of falling from height. This tool is designed to be used by construction professionals. It uses a knowledge based approach with its knowledge obtained from various sources, including Australian Occupational Health and Safety guide line. ToolSHed is useful in risk assessment, yet it is not integrated with any design information and is really only applicable for the maintenance phase of a project.

4D CAD has been used in a number of ways in design for safety. Mallasi (2006) has used entity-based 4D-CAD in the detection of workspace congestion so that potential on-site safety hazards may be identified. Benjaoran and Bhokha (2010) have used entity-based 4D-CAD with a rule-based system of safety and construction management. While there is some merit in the system, the major limitation of the system that the rules are hard-coded into the algorithms and are unable to make complex design decisions that require human input.

With the rapid growth of information technology application in construction, Building Information Modelling (BIM) has become an effective platform for the developing BIM-based automated systems to support designers in checking their designs for safety. Finland’s VTT Technical Research Centre used BIM-based 4D CAD as a central technology for construction site safety related planning activities (Sulankivi et al. 2010). This research has shown the utilization of 4D-BIM technology can result in improved occupational safety by connecting the safety issues more closely to the construction planning. However, it focussed on developing solutions for planning and management of construction site safety, and does not really address the issues of designing for construction. Qi et al. (2011) developed a dictionary and a constraint model to capture the collected design for construction worker suggestion, which are then used for a BIM-based checking system to conduct designing for construction worker safety during the design process. Although the developed dictionary could be a proper way to formalize safety knowledge, it is mainly aimed for capture falling from height issue and its structure is not clearly defined for further application. Sijie et al. (2013) have developed a system that applies automatic safety rules to BIM. They use algorithms that automatically analyse and detect safety hazards and also suggest

preventive measures for users involving falling from height. Their method is rule-based checking that uses decision table logic and is confined to dealing with the safety issue of falling from height.

Proper understanding and implementing of safety knowledge is necessary for safety improvement in construction. Gambatese and Hinze (1999) identified that over 80% of the suggestion sources of best practice for designing for safety come from just three areas: safety design manuals and checklists, researchers and research team members and interviews of on-site personal and other frequent visitors to the site. These good safety practices should be systematically captured and applied for design for safety verification. This requires an appropriate knowledge formalization framework which is not available currently in either research or industry. To overcome this gap, this paper presents a methodology to represent design for safety (DfS) knowledge. The proposed DfS knowledge model forms the foundation for developing DfS knowledge libraries and facilitates design verification through an intelligent BIM-based DfS review system.

FORMALIZATION OF DESIGN FOR SAFETY KNOWLEDGE

Design for Safety Taxonomies

The construction of DfS knowledge model is essential to manage the information and content obtained from safety acquisition. In this paper, DfS knowledge is captured into a 5-level taxonomy hierarchical model as shown in Figure 13. The first level refers to the types of design topic, including: Architectural, Structural, M&E, Geotechnical, Site and Environmental, and Temporary Structure and Machine. In general, the first three design topics are design-related and associated with permanent elements, while the last three are construction-related and associated with both permanent and temporary elements.

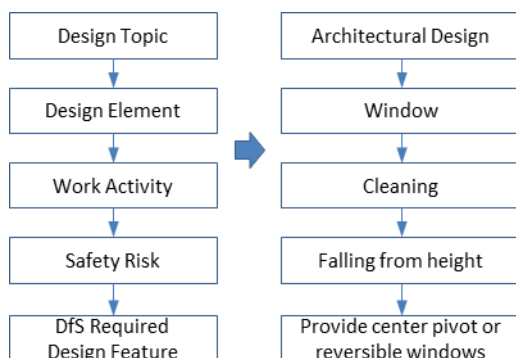

Figure 13. DfS Taxonomy Hierarchy

The second level represents the design elements as shown in Figure 14. The taxonomy includes both permanent and temporary design components. The elements under Architectural, Structural and M&E design topics are often permanent and can be extracted from 3D design models. On the other hand, those under Geotechnical, Site and Environmental, and Temporary Structure and Machine design topics are usually temporary elements and exist only during the construction phase.

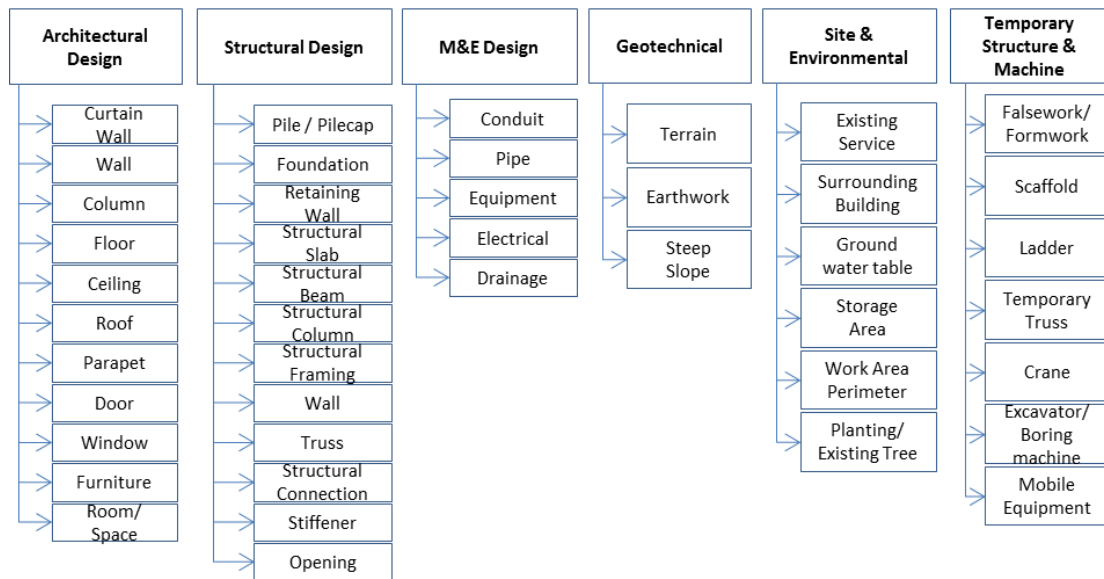

Figure 14. Design Element Taxonomy

Level Three captures the common work activity applying to the design elements. Work activities can be carried out in the construction, maintenance and operation phases of the project. The work activity library constructed in this research is presented in Figure 15.

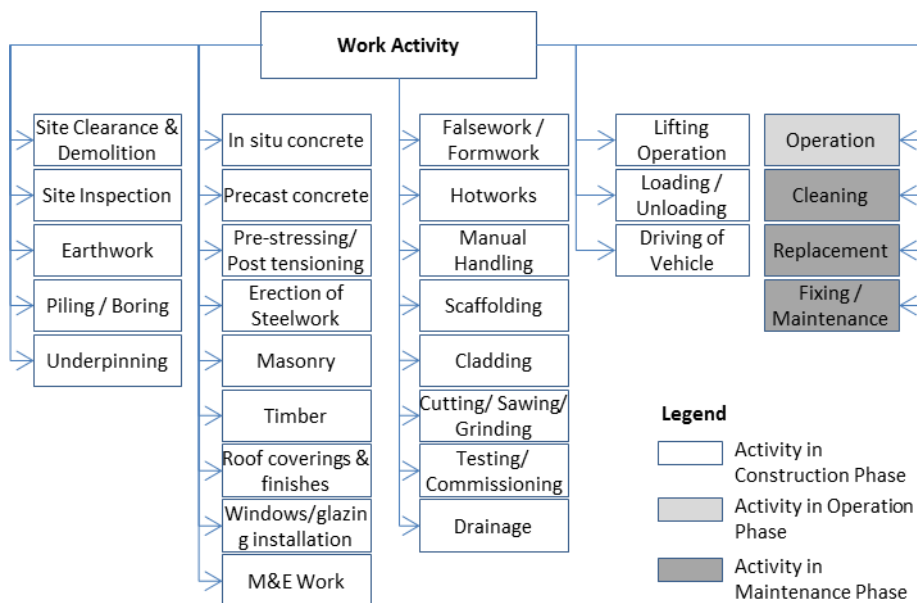

Figure 15. Work Activity Library

Level Four of the hierarchy represents the safety risk issues. The library of common safety risk issues (as depicted in Figure 16) is created based on the classification defined in safety regulation and codes, and recent construction safety accident/incident reports in Singapore.

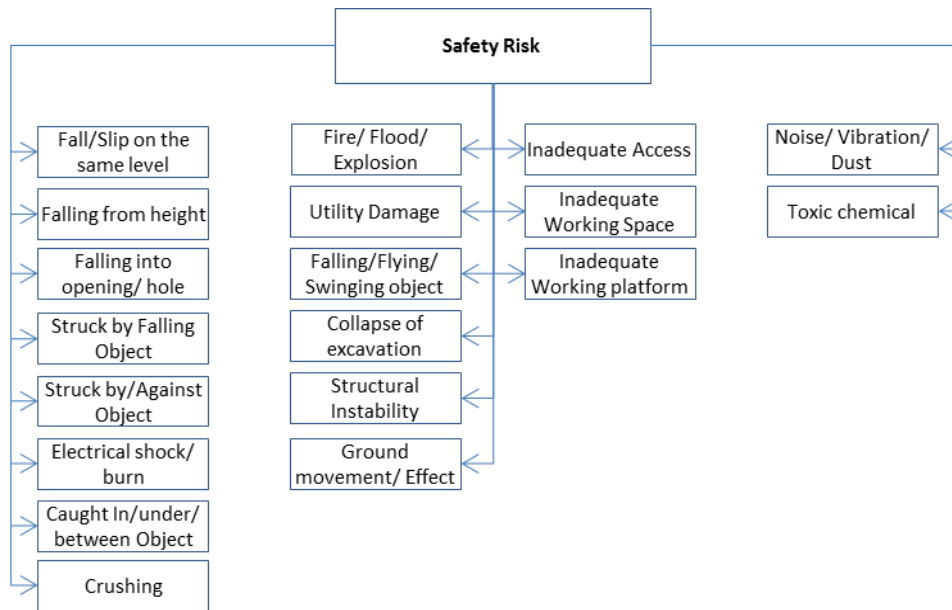

Figure 16. Safety Risk Library

The final level is used to capture the DfS required design feature. It refers to the specific design solution(s) that needs to be implemented so that the related safety issue can be eliminated through design. The formalization of a DfS required design feature is depicted in Figure 17. In particular, the design solution represented by a DfS required design feature includes a design element with topological relationship, physical, material, and functional constraints. Topological relationship constraint refers to the spatial/distance constraint between the involved design element and the one under analysis. Physical constraint represents requirements on geometry, size or weight of the design element. Material constraint defines specific type(s) of material that the design element must have to avoid the safety risk. Finally, functional constraint defines the functionality which the design element must perform. An example of functional constraint can be the loading capacity of the crane.

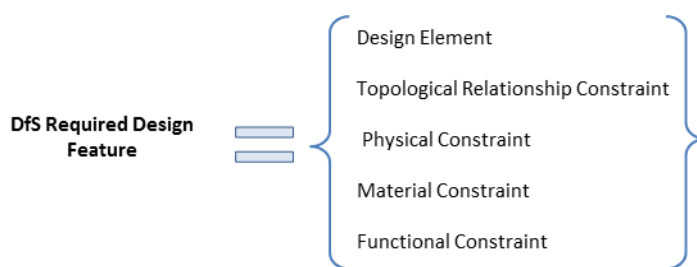

Figure 17. Formalization of DfS Required Design Feature

DfS Language Structure

A new DfS language is developed to represent DfS knowledge using proposed taxonomy hierarchical model. This DfS language aims to capture DfS knowledge in a natural descriptive language while at the same time providing syntactical structures so that the knowledge can be interpreted by reasoning algorithms. It contains a set of key words shown in upper case letters as follows:

**FOR {Design Element} WITH CONSTRAINT {constraints} WITH
ATTRIBUTE{attributes} WITH PROPERTYSET {property set attributes}
WITH MATERIAL {specify material} WHEN {Work Activity} HAVING RISK
{Safety Issue} THEN {DfS Required Design Feature}**

The condition of the knowledge rule is captured under CONSTRAINT, ATTRIBUTE and PROPERTYSET which respectively represent the intrinsic, extrinsic and relationship property of the element. These properties can be directly extracted from IFC data. Not all constraints have to be present. Logical operations AND, OR are used to represented nested condition.

For illustration, an example of DfS knowledge stated as “In order to eliminate the falling risk from open edge, a steel railing system higher than 1.0 meter need to be installed” can be represented using the above language structure as:

**FOR {Slab} WITH CONSTRAINT {Height > 900 } WITH ATTRIBUTE { } WITH
PROPERTYSET { HasOpenEdge IS true } WITH MATERIAL {Concrete} WHEN
{Operation} HAVING RISK {Falling From Height} THEN { DESIGN ELEMNT =
“Railing”, TOPOLOGICAL RELATIONSHIP CONSTRAINT = “Connected-
Above”, PHYSICAL CONSTRAINT {Height >=1.0}, MATERIALCONSTRAINT =
“Steel”, FUNCTIONAL CONSTRAINT = nil}**

FRAMEWORK FOR INTELLIGENT BIM-BASED REVIEW OF DESIGN FOR SAFETY

The proposed DfS knowledge model can be incorporated into a BIM-based system for reviewing DfS issues. The purpose of this system is to document the common DfS knowledge in a knowledge base for automatically checking the design represented in 3D models or IFC data format.

Figure 18 shows the overall workflow and architecture of the proposed intelligent BIM-based DfS design review system. The system is facilitated by a DfS knowledge base which captures safety issues during construction, repair and maintenance and the design practices commonly applied to eliminate them through design. These DfS knowledge libraries are more than an expansion of the guidelines for DfS. They will be acquired by many means, including, but not limited to, consulting relevant research literature, case studies, and semi-structured interviews with experts and practitioners. DfS knowledge will be structured so that it can be retrieved semantically as a stand-alone knowledge database that will guide practitioners during the conception of their design before the BIM model is drawn.

Two core modelling tools are then developed to capture and reason the DfS knowledge: A DfS language structure for capturing DfS knowledge and a DfS Language Parser for translating the DfS knowledge into rules for BIM query. The DfS language is flexibly designed so that the DfS knowledge can be defined from different views for different user categories. For instance, a designer may want to register their DfS knowledge based on design elements, while a safety officer does this from a hazard perspective and a contractor from an activity perspective . Figure 19 depicts how DfS knowledge can be captured from a design element view.

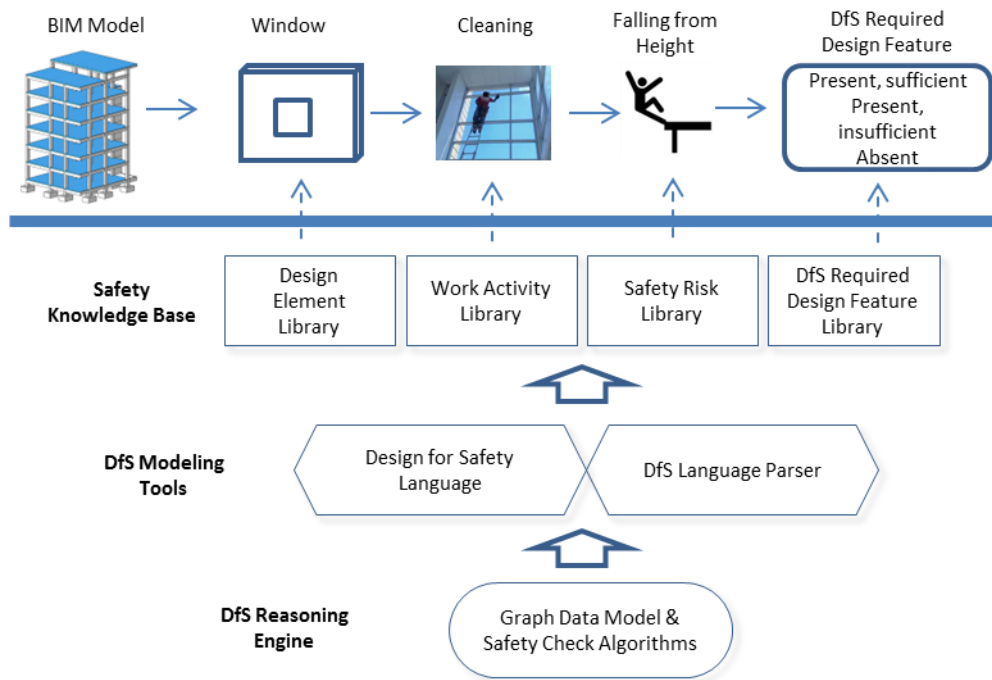

Figure 18. Overview of the Intelligent BIM-based Review of Dfs

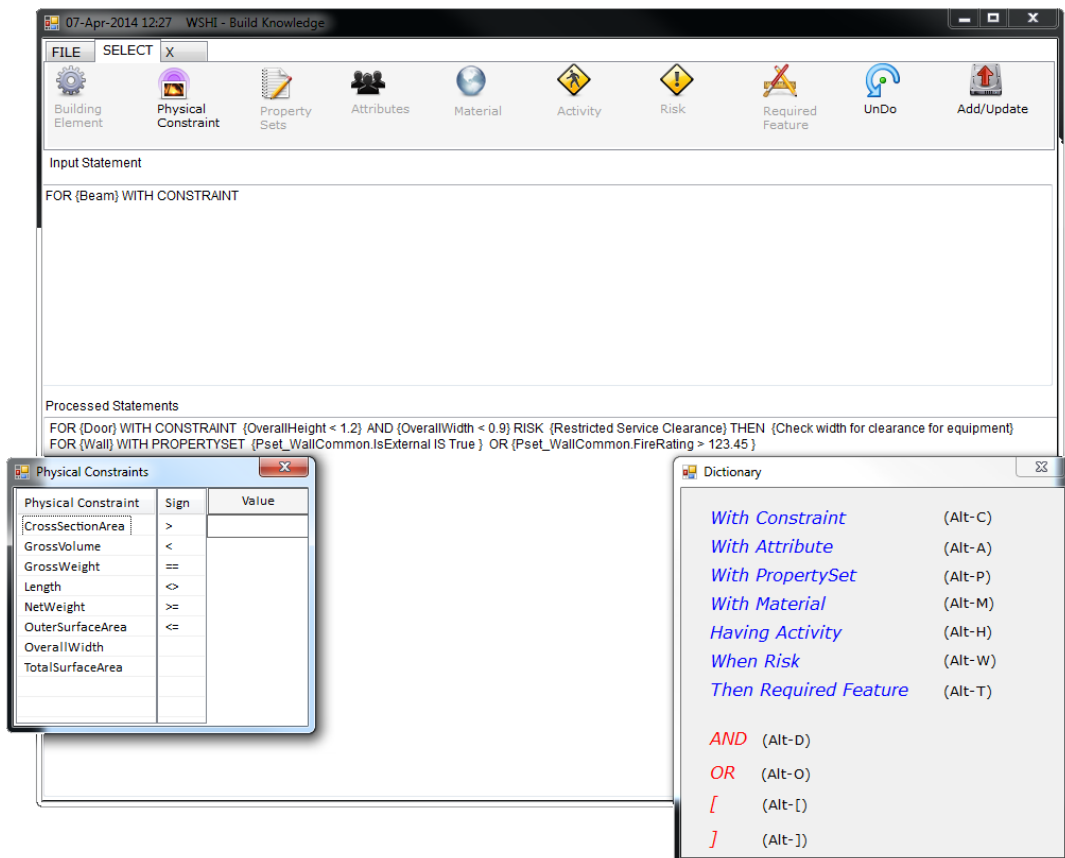

Figure 19. Registering Dfs knowledge using a design element view

The kernel of the checking system is the DfS Reasoning Engine which is built upon a graph data model to abstract BIM information and connectivity for query from safety rules, and a collection of safety checking algorithms. The reasoning engine utilizes the same structure in the safety knowledge to facilitate an intelligent design for safety review/assessment of the facility in BIM. This endeavour is only restricted to those aspects of the safety knowledge that can be measurable. Although most of the measurable attributes are readily available in BIM model there are some that will require a graph data model (GDM) to be built to facilitate the query and identification. The design hazards identified are visualized and tagged in the BIM environment and recorded within a risk register.

The checking process starts with identifying safety issue related to a design element or design element type for analysis. Then by applying the DfS knowledge stored in the DfS knowledge base, the system will perform a check if the DfS required design feature is sufficiently implemented in the design. Three outcomes of this check can be obtained: (1) Present, sufficient indicating that the DfS required design feature is present and all the constraints are fulfilled; (2) Present, insufficient meaning that the DfS required design feature is present yet at least one of the constraints is not satisfied, and (3) Absent indicating that there is no design solution implemented to eliminate the risk issue. For the first outcome, the design can be considered as “pass” and the designer does not need any further modification. In contrast, for the other two results, the insufficient/missing design feature is highlighted and the designer should apply necessary modification.

ILLUSTRATIVE EXAMPLE

A simplified example based on a clinic project (as shown in Figure 25) is used to demonstrate the main functions of the proposed system. The BIM model of this project is imported to the system through IFC data exchange. The built-in libraries' structure is based on the proposed taxonomies. These libraries allow DfS knowledge to be represented using the DfS language structure and interpreted by the reasoning engine to perform checking.

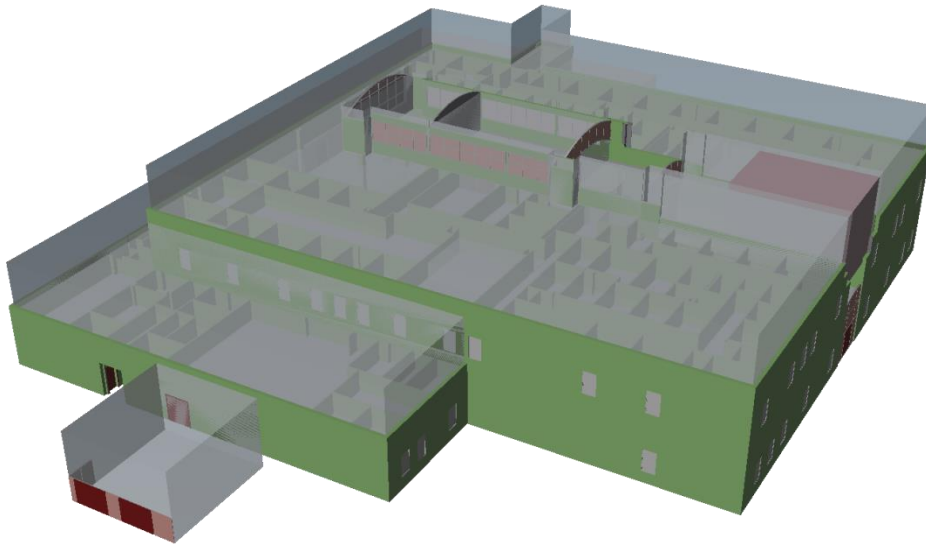

Figure 20. 3D view of the clinic building

The following DfS issue is used in this example: “For all door elements to ensure the door size is sufficiently large for moving equipment”, which is expressed in DfS language as:

```
FOR {Door} WITH CONSTRAINT { } WITH ATTRIBUTE { } WITH  
PROPERTYSET { } WITH MATERIAL { } WHEN {Operation} HAVING  
RISK {Inadequate Working Space} THEN { DESIGN ELEMNT = “Door”,  
TOPOLOGICAL RELATIONSHIP CONSTRAINT = nil, PHYSICAL  
CONSTRAINT {OverallHeight >=1.8 AND OverallWidth >=0.9},  
MATERIALCONSTRAINT = “”, FUNCTIONAL CONSTRAINT = nil }
```

After perform the DfS reviewing process, doors which do not meet the DfS Design Requirement are highlighted in both 3D and list views as shown in Figure 21. The user can navigate to a particular element by clicking its name on the list.

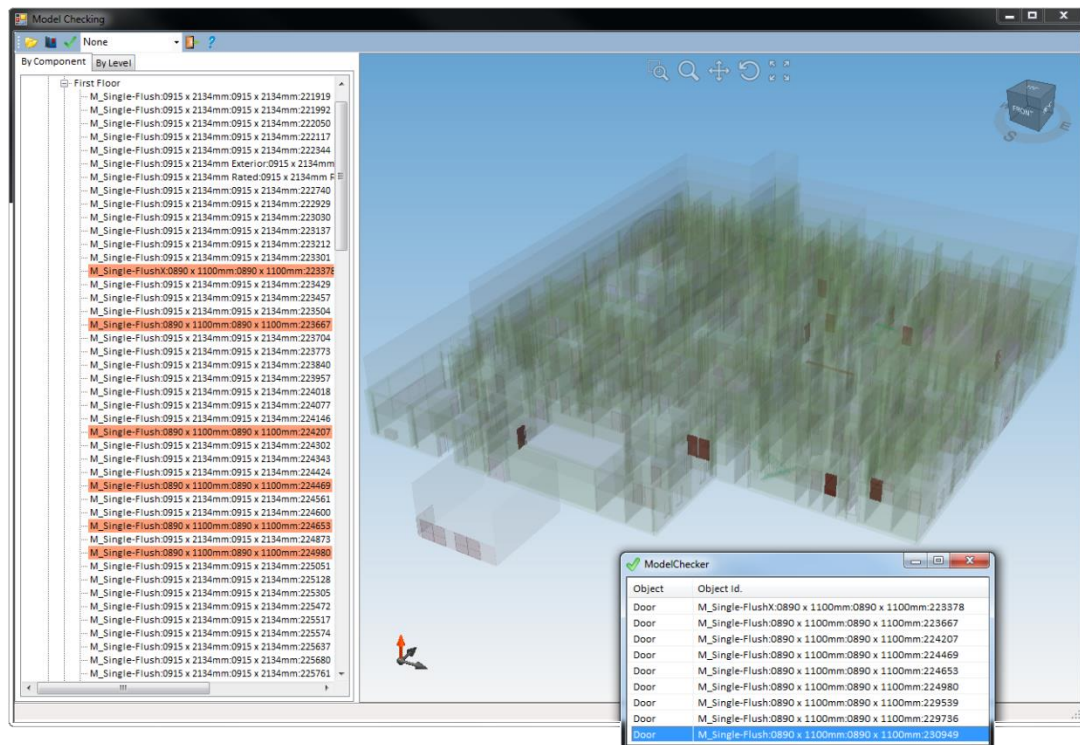

Figure 21. Checking result

CONCLUSION

This paper introduces a new methodology to capture DfS knowledge for intelligent BIM-based review of design for safety issues. This knowledge model and the comprehensive taxonomy facilitate the development of a new DfS language and provide a robust structure for acquiring and representing design for safety knowledge library. The application of this model into a BIM-based DfS review system allows safety issues can be identified and eliminated early in the design stage, and thus help reduce the work place accidents and/or incidents. From the designers and design for safety coordinator's perspective, an intelligent BIM-based system for design review will be at their disposal to enable them to identify, manage and control unsafe designs quickly and easily. Modifications to any design can be validated for unsafe aspects. The design for safety knowledge library also serves as design guides for designers during design conception before BIM model is available.

ACKNOWLEDGEMENT

We would like to thank Singapore's Workplace Safety Health Institute, the research arm of Workplace Safety and Health Council, for providing funding for this project under WSHI RPF call number MOMOSDETT12000007.

REFERENCES

- Behm, M. (2005). "Linking construction fatalities to the design for construction safety concept." *Safety Science* 43(8): 589-611.
- Benjaoran, V. and S. Bhokha (2010). "An integrated safety management with construction management using 4D CAD model." *Safety Science* 48(3): 395-403.

- Cooke, T., H. Lingard, et al. (2008). "ToolSHeDTM: The development and evaluation of a decision support tool for health and safety in construction design." *Engineering, Construction and Architectural Management* 15(4): 336-351.
- Gambatese, J. and J. Hinze (1999). "Addressing construction worker safety in the design phase designing for construction worker safety." *Automation in Construction* 8(6): 643-649.
- Gambatese, J. A., J. W. Hinze, et al. (1997). "Tool to design for construction worker safety." *Journal of Architectural Engineering* 3(1): 32-41.
- Gibb, A., R. Haslam, et al. (2004). *The role of design in accident causality. Designing for safety and health in construction: Proc., Research and Practice Symp., UO Press, Eugene Ore. .*
- Hecker, S., J. Gambatese, et al. (2004a). *Designing for safety and health in construction: An Introduction. Designing for safety and health in construction: Proc., Research and Practice Symp. , UO Press, Eugene Ore. .*
- Hecker, S., J. Gambatese, et al. (2004b). *Life cycle safety: An intervention to improve construction worker safety and health through design. Designing for safety and health in construction: Proc., Research and Practice Symp. , UO Press, Eugene Ore. .*
- Lorent, P., E. Campagnac, et al. (1991). *From drawing board to building site, HMSO Books, London.*
- Mallasi, Z. (2006). "Dynamic quantification and analysis of the construction workspace congestion utilising 4D visualisation." *Automation in Construction* 15(5): 640-655.
- Qi, J., R. R. A. Issa, et al. (2011). *Integration of safety in design through the use of building information modeling. 2011 ASCE International Workshop on Computing in Civil Engineering, June 19, 2011 - June 22, 2011, Miami, FL, United states, American Society of Civil Engineers (ASCE), 698-705.*
- Sijie, Z., J. Teizer, et al. (2013). "Building information modeling (BIM) and safety: automatic safety checking of construction models and schedules." *Automation in Construction* 29: 183-195.
- Sulankivi, K., K. Kähkönen, et al. (2010). *4D-BIM for Construction Safety Planning. CIB World Congress. Manchester, UK.*

Miscellaneous

VALIDITY AND RELIABILITY OF DEPENDENT VARIABLES: CONSIDERATIONS FOR CONSTRUCTION SAFETY RESEARCHERS

Michael Behm⁸⁹, Helen Lingard² and Jeffrey Bruening¹

1 Occupational Safety Program, East Carolina University, Greenville, NC USA

2 School of Property, Construction and Project Management, RMIT University, Melbourne, VIC Australia

The issue of underreporting of construction related injuries and illnesses to government agencies and common interest groups has developed into a plague. The aim of this paper is to draw attention to this problem and offer recommendations for construction researchers. How do we know if interventions are effective if we use insensitive and unreliable measurements as dependent variables? How do we know what works, what does not, and what is most effective at reducing risk and enhancing safety? How can we compare across countries, companies, or trades? Descriptive and intervention research requires both valid and reliable measurements. Construction safety and health research, like all occupational safety and health research, relies heavily on lagging indicators such as injury and illness rates as dependent variables and descriptors. For quite some time, the validity and reliability of injury and illness statistics has been called into question. Poorly developed and managed incentive programs and the desire to look good have caused injury and illness rates to plummet, whereas fatality rates have not experienced the same reduction. However, the effect of this phenomenon on researchers has not been given sufficient attention. Through a review of literature and research methodology guidance we evaluate the use of lagging indicators as dependent variables in construction safety and health research. The practical implications will provide for a debate amongst conference participants and readers. The social implications are wide as we will reveal the professional and ethical implications for practitioners and researchers.

Keywords: injury statistics, measurement, reliability, underreporting, validity.

INTRODUCTION

The blatant underreporting of workplace related injuries and illnesses to government agencies and common interest groups has developed into a plague. Leigh et al. (2004) estimated the Annual Survey conducted by the Bureau of Labor Statistics (BLS) misses between 33% - 69% of injuries sustained. The United States (US) House of Representatives (2008) reported that as much as 69 percent of injuries and illnesses may never make it into the Bureau of Labor Statistics (BLS) annual Survey of Occupational Injuries and Illnesses. They found that due to the Occupational Safety and Health Administration's (OSHA) reliance on employer's self-reporting and the fact that employers have strong incentives to underreport injuries and illnesses that occur on the job. For example, they report that "Businesses with fewer injuries and illnesses are less likely to be inspected by OSHA; they have lower workers'

⁸⁹ behmm@ecu.edu

compensation insurance premiums; and they have a better chance of winning government contracts and bonuses.” (US House 2008). This is not a new phenomenon. In 1988, the US General Accounting Office investigated the problem of inaccurate injury and illness reporting. They concluded that employers deliberately underreport injuries in response to incentives such as OSHA inspection policies or employer safety competitions. The US Government Accountability Office (2009) recommended that OSHA should be auditing organization’s accuracy of injury and illness reporting.

In April 2013, a construction safety manager was sentenced to jail for 78 months because he did not report over 80 injuries in order for his company to win \$2.5 million USD in bonuses for safety incentives built into a government contract (US Department of Justice, 2013). While analyzing BLS statistics, Elgin (2010) concluded that it is more dangerous to serve coffee at Starbucks or work as a bank teller compared to working in a steel mill like AK Steel that touts its impeccable safety record.

The issue is global. In New Zealand, Wall (2013) found that tunnel construction workers were told to lie about their injuries and say they happened off the job in order to protect their safety record and reduce costs. Taylor (2013) reports of significant underreporting in the South African construction sector due to poor recordkeeping practices, but recognizes the governmental reporting structure may be partly to blame. In the United Kingdom, Daniels and Marlow (2005) found that the reporting of non-fatal construction injuries is as low as 46%. In Australia, ‘official’ construction health and safety statistics are based on workers’ compensation claims made by employees, yet it is well known that these represent only a fraction of the actual occurrence of work injuries. For example, self-employed and some casually employed workers, (prevalent in construction) are not covered by state compensation schemes and, thus, their injuries are excluded (Mayhew and Quinlan 2001). This is a significant problem if accident data is used as the basis for diagnosing health and safety problems, targeting “hotspots” and evaluating interventions.

Construction safety and health academicians and researchers must be concerned about the severe underreporting of workplace injuries and illnesses. How can we accurately describe the issues that need the most attention? How can we develop interventions that focus on the most prevalent risks and hazards? And how can we measure the effectiveness of interventions? This proceedings paper highlights the research implications surrounding lagging indicators, highlights a recently developed multi-level index, and calls for future research on the topic.

Safety Incentive Programs

OSHA recently recognized the danger that some incentive programs can have on underreporting. OSHA (Fairfax 2012) issued a memorandum highlighting the legality of accurate reporting and the danger of some incentive programs. One specific example of an incentive program given is, “an employer might enter all employees who have not been injured in the previous year in a drawing for a prize, or a team of employees might be awarded a bonus if no one from the team is injured over some period of time” (Fairfax 2012). Employees involved in these types of incentive schemes may not report injury for fear of losing out on the prize or reward.

Probst and Estrada (2010) surveyed 425 employees from 5 different industry sectors. They found that, on average, employees in their study admitted to not reporting 2

accidents for every 1 that was reported. A primary reason was that many employees were afraid of reporting as they may lose incentives, which “points to misguided safety incentive systems that reward for safety outcomes rather than safety behavior” (p 1442). Another reason was the safety climate within the organization. When employees perceive their organizational safety climate to be positive, they engage in far less under-reporting (ratio of unreported to reported accidents = 1.46:1). When employees report having supervisors who enforce safety policies, they not only experienced far fewer accidents, but they also fully reported all of those accidents. In contrast, among employees who perceived a poor safety climate and/or lax enforcement, the ratio of unreported to reported accidents was greater than 3:1 (Probst and Estrada 2010). It is ironic (and counter-intuitive) that companies with improving safety cultures often experience an initial increase in accidents!

Lipscomb et al. (2013) surveyed over 1,000 union carpenter apprentices and found that less than half of them stated that injuries in their workplace were reported all or almost all of the time. Over 30% said that injuries were never or almost never reported. The title of the Lipscomb et al. (2013) manuscript is most revealing – “Safety, Incentives, and the Reporting of Work-Related Injuries among Union Carpenters: ‘You’re Pretty Much Screwed If You Get Hurt at Work’”. Although they find multiple reasons and layers of disincentives for the underreporting of construction injuries, the focus is on incentive programs.

Attractiveness to win bids

In the construction sector, an organization’s safety record can be a factor in winning a contract or being eligible to place a bid. In the New Zealand tunnel worker case, Wall (2013) reported that “former workers said supervisors were obsessed with avoiding LTIs - lost time injuries - which were all-important when tendering for lucrative new contracts.” Welch et al. (2007) describe the change by clients in the late 1980’s to prequalify bidders with a focus on safety records. These authors coincide this, along with other industry shifts, with the dramatic decrease in reported injury rates in construction.

Probst et al. (2008) finds that a company’s OSHA injury rate can influence that company’s eligibility and competitiveness to bid on future contracts. They also found a moderating effect of safety climate. Construction companies with a poor safety climate had significantly higher rates of underreporting compared with organizations with a positive safety climate. They warn that companies with poor safety climates that also underreport injury rates may be receiving short term rewards for doing so; however, the long-term health and safety of their workers, workers’ compensation costs, and costs associated with not fixing safety and health problems may outweigh the short term benefits.

Validity and Reliability

Researchers must ensure that any measurement used is valid and reliable. With injury and illness statistics, we are focusing in this paper on underreporting, and this is a systematic error. A systematic error is one that makes an error consistently in the same direction. In this case it is underestimation. Validity is ability of a measurement to be accurate or centered on the true value (the pictorials at the top of Figure 1

below). Reliable measurements have a low degree of scatter (the pictorials on the left side of Figure 1 below).

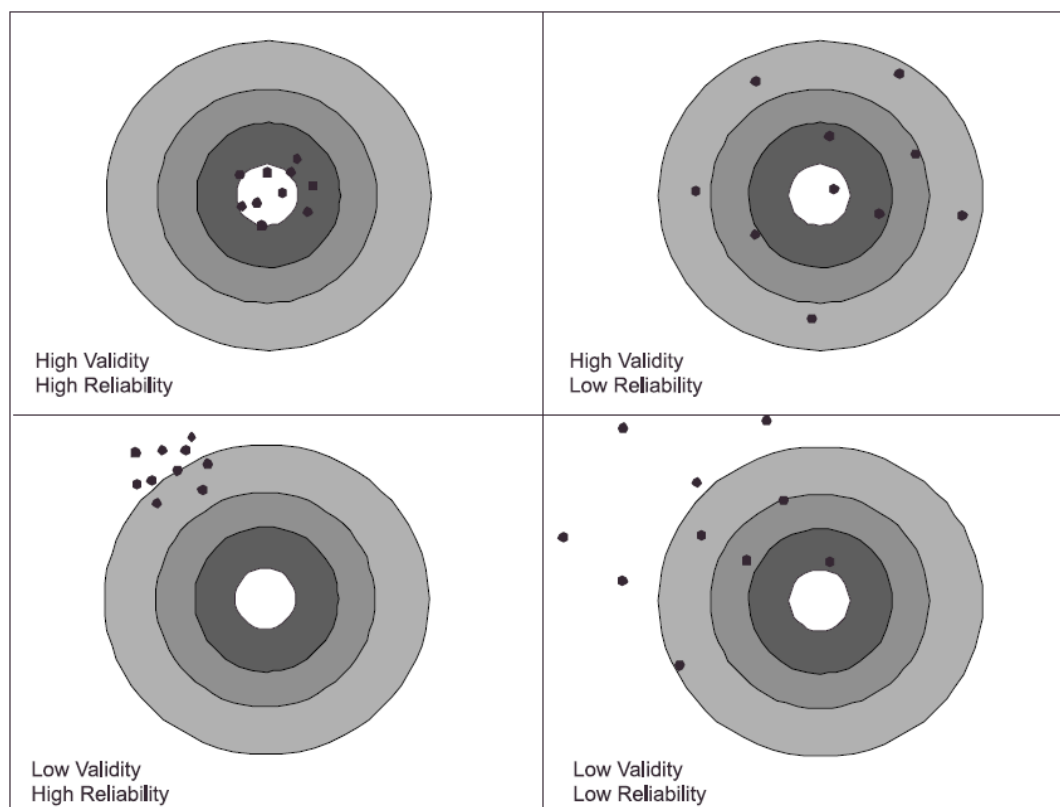

Figure 1. Illustrations showing validity and reliability (Robson et al. 2004)

Adams and Hartwell (1977) described issues with safety records in the United Kingdom, and call the improvement in reporting and recording systems a prerequisite to any research endeavor. They describe a reporting flow chart to show how information may be lost or underreported throughout a workplace system (Adams and Hartwell 1977). Webb et al. (1989) developed a filter model of underreporting using six levels; they also suggest that the true incidence of workplace injuries may never be known. The model depicts how communication and interaction between key individuals starting from the worker on up to government agencies operate (Webb et al, 1989). Because of the biases within the filtering, Webb et al. (1989) question the validity of national injury statistics.

Robson et al. (2001: 55) warned that the “degree of underreporting can be a great source of bias”. Their focus is on evaluating intervention research; they warn that many types of incentives programs, such as direct to individuals and organizations, encourage underreporting or reclassifying an injury or illness to one of lower severity. Furthermore, the intervention itself can have an impact on the validity and reliability of injury and illness rates. Management auditing interventions tend to improve or increase reporting, whereas incentive or behavioral programs discourage and decrease reporting (Shannon et al. 1999).

Robson et al. (2001) advise that when planning an intervention, the researchers should investigate data validity before any data collection, and if necessary, take corrective steps to improve data collection. They do not, however, provide any guidance on how to do that or any examples. Robson et al. (2001) also advise researchers to monitor

the validity of injury rates during and after the intervention. Here, they recommend using: a) multiple reports of injuries and illnesses, such as supervisor, clinic, and claims reports, and b) a ratio of minor injuries to major injuries.

Cochrane Review

The Cochrane Review (van der Molen et al. 2013) set out to assess archival research to determine the effects of interventions to prevent injuries to construction workers. They evaluated primarily study design. They reviewed 1766 references, carefully examined 117 potential eligible articles and selected 13 which fit the criteria of a “randomised controlled trials, controlled before-after (CBA) studies and interrupted time series (ITS) of all types of interventions for preventing fatal and non-fatal injuries among workers at construction sites” (p 1). For the study to be included in the review, work-related injury must have been utilized as an outcome measure. The Cochrane Review did not evaluate or mention reliability or validity of the outcome measures in their review.

IMPLICATIONS

Practitioners and the construction industry need to be concerned about this unfortunate phenomenon. Firstly, construction incidents are valuable sources for learning about unacceptable risks within the organization (Gibb et al. 2014; Behm and Schneller 2013; Lindberg et al. 2010; Kletz 2006). Secondly, injury rates are typically an indicator of resource allocation. If injury rates are not valid or misrepresent safety risks, then an entity (company, industry, country) cannot make appropriate investment decisions to reduce workplace injury and illness. For construction safety and health researchers this underreporting creates a situation where the most important research questions may not be able to be developed because we do not understand the problems. Further, when interventions are developed, we need to take special precautions that we consider the validity and reliability of our dependent variables.

We contend that the deliberate underreporting of work related injuries and illnesses in the construction industry is an ethical dilemma that transcends economics and worker safety and health outcomes. If clients are using safety and health records as means to prequalify for bids, then those firms that underreport their records are at an unfair advantage to win contracts compared to firms that are honest. How can a client trust such data to make an important decision as to whether or not one is prequalified to bid on a job? Further, as we alluded to earlier, learning from incidents is an important aspect of safety and health programs. Construction firms cannot learn from incidents if they go unreported or ignored. Therefore, they cannot implement programs to positively effect change.

Because of the continued problems with this data, Welch et al. (2007) question the importance collecting such injury and illness information at all, since the data is not honest data. They conclude that the construction industry needs to find better methods of measuring health and safety performance (Welch et al. 2007).

Fatalities are difficult to hide and underreport. Using data from the Construction Chart Book (CPWR 2013), we analyzed the reductions in fatality rates versus nonfatal injury rates that resulted in days away from work in the U.S. Since 1992, construction fatalities have decreased 31%, whereas nonfatal injury rates that resulted in days away from work decreased 70%. Welch et al. (2007) analyzed similar trends in the 1990's, and make similar observations. They used injury rate for all injuries rather than days

away from work which we used. They acknowledge that the construction industry is improving its health and safety. However, they question the disparity, “Safer workplaces should decrease fatalities as well as injuries, but the fatality rate in construction has not declined, and the largest reduction in injuries is for those that do not entail days away from work” (Welch et al. 2007: 44). Is it possible that, rather than reducing, non-fatal injuries are being more effectively “hidden”?

RECOMMENDATIONS

The construction industry should be deeply troubled by the lack of integrity of their safety and health data. Construction safety and health researchers should ensure the validity and reliability of any outcome measures and discuss how they took steps to verify or ensure that validity and reliability. We find this as a major gap in construction OSH research, and one that negatively influences practice.

In response to the construction industry’s reliance on lagging indicators, Lingard et al. (2013) developed an OHS index (The RMIT OHS Index) which includes three categories of measurement: lagging indicators, leading indicators, and safety climate measures. See Figure 2.

Leading indicators within the model have been derived from a construction accident causation model developed by Haslam et al. (2005). Leading indicators have been developed for all 22 circumstances, factors, and influences found within the accident causation model. Lingard et al. (2013) reported that the RMIT Index is being utilized by several large clients, and that its reliability and validity will be comprehensively evaluated. We encourage construction safety and health researchers and the construction industry to monitor the Index’s validation and consider using such holistic measures as the RMIT OHS index.

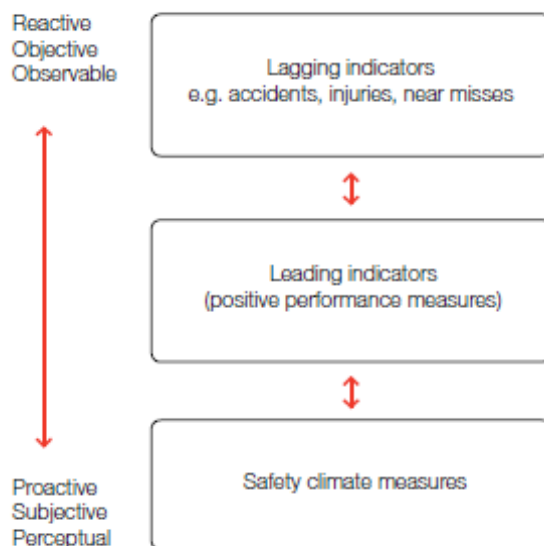

Figure 2. The RMIT OHS Index. (RMIT 2013)

FUTURE RESEARCH

We believe that additional descriptive research should be completed to adequately describe the problem of underreporting and potential solutions. This research should focus on all levels within organizations and the construction industry, from workers

and prime contractors to industry trade associations and owners that give safety awards and prequalify for bids. We recommend that the essence of such an inquiry should focus on why this underreporting is occurring and how it could be reduced and eliminated.

Additional social science research should focus on construction safety and health professionals and their role in the underreporting crisis. Most safety professionals join professional associations which have codes of ethics. Professional organizations should make underreporting a specific issue or point of emphasis within their codes of ethics or supplementary materials.

Because injury and illness rate use is so prevalent within the construction industry, we recommend a thorough literature review of the use of injury and illness rates in archival journal articles and conference proceedings. Similar to the Cochrane Review (van der Molen et al. 2013), this should focus on how these rates are used in construction safety and health research, and how, if at all, researchers are documenting the validity of their measurements.

Researchers should consider the RMIT OHS Index as a future measurement in their descriptive and intervention research. As the research group from RMIT validate the Index and collect more data, this could be one OHS measurement method to consider for broader industry adoption.

REFERENCES

- Adams, N. L. and Hartwell, N. M. (1977). Accident-reporting systems: A basic problem area in industrial society. *Journal of Occupational Psychology*, 50, 285-298.
- Behm, M. and Schneller, A. (2013). Application of the Loughborough Construction Accident Causation Model: A Framework for Organizational Learning. *Construction Management and Economics*, 31 (6), 580-595.
- CPWR (2013). The Construction Chart Book, 5th edition. The Center for Construction Research and Training. Silver Spring, MD. April 2013. ISBN: 978-0-9802115-1-1.
- Daniels, C. and Marlow, P. (2005). Literature review on the reporting of workplace injury trends, HSL/2005/36, Health and Safety Laboratory, HSE, London.
- Elgin, B. (2010). Caution: Stats may be slippery: Why claims of an almost miraculous decrease in U.S. worker injuries don't stand up to scrutiny. *Bloomberg BusinessWeek*. March 22 & 29, 2010. 57-59.
- Fairfax, R. (2012). Employer safety incentive and disincentive policies and practices. www.osha.gov/as/opa/whistleblowermemo.html March 12, 2012.
- Gibb, A., Lingard, H., Behm, M., and Cooke, T. (2014). Construction Accident Causality: Learning from Different Countries and Differing Consequences. Accepted in *Construction Management and Economics*.
- Goldenhar, L. and Schulte, P. (1994). Intervention research in occupational health and safety. *Journal of Occupational Medicine*, 36 (7): 763-775.
- Haslam, R., Hide, S., Gibb, A., Gyi, D., Pavitt, T., Atkinson, S. and Duff, A. (2005). Contributing factors in construction accidents. *Applied Ergonomics*, 36 (3), 401-51.
- Kletz, T. (2006) Accident investigation: keep asking 'why?' *Journal of Hazardous Materials*, 130(1-2), 69-75.

- Leigh, J.P., Marcin, J.P., Miller, J.R. (2004). An estimate of the U.S. government's undercount of nonfatal occupational injuries. *Journal of Occupational and Environmental Medicine*, 46, 10-18.
- Lindberg, A., Hansson, S. and Rollenhagen, C. (2010). Learning from accidents – what more do we need to know? *Safety Science*, 48 (6), 714-721.
- Lingard, H., Wakefield, R., and Blismas, N. (2013). “If you cannot measure it, you cannot improve it”: Measuring health and safety performance in the construction industry.” CIB World Building Congress, Brisbane, QLD.
- Lipscomb, H. Nolan, J., Patterson, D., Sticca, V. and Myers, D. (2013). Safety, Incentives, and the Reporting of Work-Related Injuries among Union Carpenters: ‘You’re Pretty Much Screwed If You Get Hurt at Work’. *American Journal of Industrial Medicine*, 56, 389-399.
- Mayhew, C. & Quinlan, M. (2001), The effects of changing patterns of employment on reporting occupational injuries and making worker compensation claims, *Safety Science Monitor*, 5, 1-12.
- OSHA (2012). Employer Safety Incentive and Disincentive Policies and Practices. US Department of Labor, Occupational Safety and Health Administration, Office of Whistleblower Protection Programs. 12 March 2012.
<https://www.osha.gov/as/opa/whistleblowermemo.html>
- Probst, T., Brubaker, T., and Barsotti, A. (2008). Organizational Injury Rate Underreporting: The Moderating Effect of Organizational Safety Climate. *Journal of Applied Psychology*, 93 (5), 1147-1154.
- Probst, T., and Estrada, A. (2010). Accident under-reporting among employees: Testing the moderating influence of psychological safety climate and supervisor enforcement of safety practices. *Accident Analysis and Prevention*, 42, 1438-1444.
- RMIT (2013). Work safety and health performance: Measurement and benchmarking. Originally downloaded on 8 October, 2013. Now found at,
<http://mams.rmit.edu.au/f4w1hpk1elvj.pdf>.
- Robson, L., Shannon, H., Goldenhar, L., and Hale, R. (2001). Guide to Evaluating the Effectiveness of Strategies for Preventing Work Injuries: How to show whether a safety intervention really works. Centers for Disease Control and Prevention, National Institute for Occupational Safety and Health. April 2001. DHHS (NIOSH) Publication No. 2001-119.
- Shannon, H.S., Robson, L.S., and Guastello, S.J. (1999). Methodological criteria for evaluating occupational safety intervention research. *Safety Science*, 31, 161-179.
- Taylor, J. (2013). Construction injuries going unreported, legal expert warns. *Engineering News. Creamer Media. 13 June 2013. Downloaded 16 September 2013 from <http://www.engineeringnews.co.za/article/law-firm-highlights-concern-for-health-and-safety-in-the-construction-industry-2013-06-07>***
- United States Department of Justice (2013). Former Shaw Group Safety Manager at TVA Nuclear Sites Sentenced To 78 Months In Prison For Major Fraud Case Against The United States. United States Attorney William C. Killian Eastern District of Tennessee. Downloaded 16 September, 2013 from,
<http://www.justice.gov/usao/tne/news/2013/April/041213%20Cardin%20Sentencing%20Fraud.html>

- United States General Accounting Office (1988). Occupational Safety & Health: Assuring Accuracy in Employer Injury and Illness Records. Report to the Chairman, Subcommittee on Labor, Health and Human Services, and Education, Committee on Appropriations, U.S. Senate. Washington, D.C.
- United States Government Accountability Office (2009). Workplace Safety and Health: Enhancing OSHA's records audit process could improve the accuracy of worker injury and illness. October 15, 2009. <http://www.gao.gov/products/GAO-10-10>.
- United States House of Representatives (2008). Hidden Tragedy: Underreporting Of Workplace Injuries and Illnesses. A Majority Staff Report by The Committee on Education And Labor U.S. House of Representatives. The Honorable George Miller, Chairman.
- van der Molen, H.F., Lehtola, M.M., Lappalainen, J., Hoonakker, P.L.T., Hsiao, H., Haslam, R., Hale, A.R., Frings-Dresen, M.H.W., and Verbeek, J.H. (2013). Interventions to prevent injuries in construction workers. The Cochrane Collaboration. Published by John Wiley & Sons, Ltd. <http://www.thecochranelibrary.com>
- Wall, T. (2013). Tunnel workers 'told to lie about injuries'. *Sunday Star Times*. 25 August 2013. Downloaded 16 September 2013 from <http://www.stuff.co.nz/business/industries/9083657/Tunnel-workers-told-to-lie-about-injuries>
- Welch, L., Dong, X., Carre, F., and Ringen, K. (2007). Is the apparent decrease in injury and illness rates in construction the result of changes in reporting? *International Journal of Occupational and Environmental Health*, 13, 39-45.

THE POTENTIAL OF BIM FOR SAFETY AND PRODUCTIVITY

Teo Ai Lin Evelyn⁹⁰, George Ofori, Imelda Krisiani Tjandra and Hanjoon Kim

¹ Department of Building, National University of Singapore, 4 Architecture Drive, Singapore 117566

A research project, aiming at investigating a scientific way to integrate construction safety and productivity performance together, and to design a comprehensive monitoring system for improving productivity and safety adopting the Building Information Modelling (BIM) approach, is currently underway. As the application of BIM is now a compulsory requirement in Singapore construction, its potential should be maximised. Hence, this study aims at studying the relationship between productivity and safety, and how the application of BIM can help to enhance the level of performance on these two project parameters. The data collection method includes questionnaire survey, face-to-face interviews and case studies. With BIM, the potential to enhance safety while improving productivity can be investigated.

Keywords: productivity, safety, BIM.

INTRODUCTION

In Singapore, the current national focus on productivity and safety enhancement, as well as information and communications technology (ICT) applications at the highest levels provides the opportunity to investigate the potential which an understanding of the relationship between the two project performance criteria offers for enhancing productivity and safety performance on construction projects. As the application of Building Information Modelling (BIM) is now a compulsory requirement in Singapore construction, its potential should be maximised. Hence, this study aims at studying the relationship between productivity and safety, and how the application of BIM can help to enhance the level of performance on these two project parameters.

BACKGROUND

Productivity has been accorded top priority in the current growth strategy for Singapore's economy (Economic Strategies Committee, 2010). The Committee has set a challenging target to achieve productivity growth of two to three percent per year over the next 10 years, more than double the one percent rate achieved over the last decade. The challenge is even greater in construction because, in Singapore, this important sector of the economy is not able to keep pace with the other sectors in terms of technological advancements and the realisation of productivity gains. As in many other countries, the construction industry is confronting a crisis with the convergence of many factors which result in gross inefficiency (Smith and Tardif, 2009). One of the major causes of this inefficiency can be attributed to the productivity lost from workplace incidents. Hence, safety and other elements of

⁹⁰ bdgteal@nus.edu.sg

performance on site play an important role in the national push for higher productivity.

In order to achieve significant productivity growth in the construction industry in Singapore, many programmes and initiatives have been launched over the years. These have included the provision of incentives for mechanisation; promotion of modular co-ordination, standardisation and prefabrication; introduction of objective measures of buildability of design; promotion of design-and-build; introduction of regulations requiring minimum levels of buildability; and national awards for good performance in buildability (Ofori et al., 2011a). More recently, as part of an economy-wide drive to enhance productivity in order to increase competitiveness, the Singapore government has introduced a S\$250-million Construction Productivity and Capability Fund (CPCF) to assist companies in the construction industry in its efforts to improve the levels of productivity (BCA, 2014b). The fund, introduced in 2010, comprises incentive schemes to promote workforce development, technology adoption and capability development in Singapore's built environment. A BIM Fund has also been introduced as part of the CPCF Fund to help the construction industry to build new capability in BIM technology and to incorporate BIM into its work processes to improve productivity and to offer new value-added services. In 2014, the CPCF has been increased by S\$30 million to benefit more companies (Lee, 2014). As part of the increment, the BIM fund has been enhanced to provide stronger support to the industry in raising productivity and building up capabilities (BCA, 2014c). With the enhancement, a firm is allowed to double the number of applications from 3 to 6. The \$210,000 cap for project collaboration scheme has been removed to encourage more project partners to use BIM collaboratively. A one-time support for expenditure of manpower involved in setting up the firm's BIM deployment plan is also added to the list of supportable items. For the first application only, firms may also use a past or completed project in place of the ongoing or upcoming project with a minimum GFA of 100sqm.

On the safety front, in view of the ambitious target set by the Prime Minister to reduce the fatality rate to 1.8 per 100,000 employed persons by 2018 (MOM, 2008), the authorities have developed various National Workplace Safety and Health Strategies. Again, in spite of the many strategies introduced by the authorities, the workplace fatality rate was 2.1 and 5.9 per 100,000 employed persons in 2012 for all sectors and for the construction sector respectively (WSHI, 2013). It would appear that the construction sector has not realised much improvement in safety performance and it might be the sector that would find it most difficult to attain the target of the workplace fatality rate of 1.8 per 100,000 employed persons by 2018. With such poor safety performance, it is also apparent that there is a serious demand for a system to help the construction industry to monitor the safety performance to achieve zero accidents, and hence to reduce the fatality rate to 1.8 per 100,000 employed persons by 2018.

There have also been long-standing efforts to improve the safety performance of the construction industry. These have included: minimum requirements for training in safety; requirements for safety managers to be employed; enhancement of the regulatory framework to encourage the integration of safe and healthy practices at the workplace by employers and employees; and requirements for building strong capabilities in Workplace Safety and Health (WSH) management (Ofori et al., 2011b).

The decades-long efforts to realise improvement in both productivity and safety have not yielded much results for several reasons. Among these are: the large number of inter-related factors which contribute to performance levels in either area; the nature of the structure of the construction industry itself; and the influence of factors outside the project and the construction industry which are beyond the control of the practitioners. In order to realise efficiency, the construction industry has to think of new means and methods of production to enhance productivity. The industry should also improve its safety levels and reduce the many adverse effects of its poor safety performance.

The Building and Construction Authority (BCA), together with buildingSMART Singapore, have been promoting the use of BIM as the platform to facilitate the integration of knowledge in design and construction, and handing over to facilities management. BIM offers tools to help designers and contractors anticipate design problems during the early stages of a project, minimising unnecessary work during the construction phase. Hence, the BCA has identified BIM as a key technology to improve productivity and level of integration across various disciplines across the entire construction value chain (BCA, 2014a).

Given this potential, it is pertinent to consider how BIM can provide the platform for integrating the performance criteria on a construction project. The BCA has indicated that the Singapore construction would use BIM widely in 2015, and that this will be achieved in stages. In 2013, architecture BIM e-Submissions were made mandatory for all new building projects with Gross Floor Area (GFA) of more than 20,000 sqm. In 2014, engineering BIM e-Submissions will be made mandatory for all new building projects with GFA of more than 20,000 sqm. In 2015, architecture and engineering BIM e-Submissions will be made mandatory for all new building projects with GFA of more than 5,000 sqm. As the application of BIM becomes a compulsory requirement in Singapore construction, its potential benefits should be maximised. The unbundling and analysis of the factors which influence project performance is important in order to address some of the endemic problems of the construction industry which hinder its progress towards excellence.

AIMS

The research study focuses on the construction industry, specifically on the areas of productivity, safety and BIM. The aim of this research study is to investigate a scientific way to integrate safety and productivity performances together, and to design a comprehensive monitoring system for improving productivity and safety through the application of BIM. The specific objectives of the study are (i) to determine the relationship between productivity and safety; and (ii) to study the potential of BIM to facilitate the attainment of productivity and safety improvement.

LITERATURE REVIEW

AGC (2010) defines Building Information Modelling (BIM) as the development and use of a computer software model to simulate the construction and operation of a facility. The resulting model is a data-rich, object-oriented, intelligent and parametric digital representation of the facility, from which views and data according to users' needs can be extracted and analyzed to be used for decision making and process improvement.

According to Smith (2007), BIM "will make a great impact in the way a construction project is managed and will also bring along a safer jobsite". Other benefits of BIM include faster and more effective processes, better design and quality (Azhar, 2011), being a collaboration tool for designers, project engineers, safety officers, and other project participants which can raise safety awareness of the team (Benjaoran and Bhokha, 2010), reducing much of the manual efforts, time and cost saving, improving the performance of onsite operations (Gong and Caldas, 2011) and identifying the likely conflicts and risks that would have arisen due to the changes in work practices (Gu and London, 2010).

The potential of BIM for safety improvement has been explored by a number of authors. Ku and Mills (2008) focus on design-for-safety (Dfs) concepts. Safety in design concept includes hazard analyses and risk assessments. Prevention through Design (PtD) tools have the potential to support and improve designers' knowledge and skills of hazard recognition. They investigated the developments in BIM and computer tools for safety into design review and simulation which may enhance Dfs process.

Zuppa et al. (2009) studied the perception of BIM's impact on one success measure (i.e. productivity, schedule, safety, cost or quality), and found that among these success measures, BIM had the strongest perceived positive impact on the quality, cost and schedule of construction projects.

Zhang et al. (2013) describe the application of automated safety rule checking to Building Information Models (BIM). The system automatically analyzes a building model to detect safety hazards and suggest preventive measures to users. The developed automated safety checking platform informs construction engineers and managers of the various safety measures needed for preventing fall-related accidents before construction starts.

As compared to BIM for safety, the potential of BIM for productivity improvement has not been widely explored. There is a lack of systems that estimate future productivity by factoring in real-time information. Gelisen and Griffis (2014) develop a tool which allows a company to predict, manage, and even optimize the productivity associated with a project or levels of projects.

Despite the potential to improve construction project performance, there are various challenges in implementing BIM, as outlined by Rajendran and Clarke (2011). Some of these challenges are also relevant to the construction industry in Singapore. Since BIM is relatively new to the construction industry, many contractors and designers are not familiar with BIM. Some changes are required in the contractor selection process, since BIM experience should now be considered. In terms of cost, BIM is expensive and requires a significant up-front investment.

Many approaches focus on the improvement of safety or productivity separately. However, because of the positive relationship between productivity and safety performance (Sawacha et al., 1999), workers try to achieve faster production, which might imply the use of unsafe methods of work by chance-taking. As such, an approach incorporating both safety and productivity considerations is necessary. Hence, this study attempts to incorporate both productivity and safety using the BIM technology.

RESEARCH FRAMEWORK

This study follows a conceptual framework depicted in Figure 1. The study will find out the link between productivity and safety performance and then propose a BIM Intelligent System. Both productivity and safety will be measured at two main levels: project level and trade level (i.e. formwork installation, reinforcement placing and fixing, concrete placement, drywall installation, painting, timber door installation, wall tiling, floor tiling, suspended ceiling installation, air-conditioning ducting installation, electrical conduit installation and water pipe installation).

The study will consider the integration of two previously developed indices: the Safety Culture Index (SCI) and the Construction Safety Index (CSI) (Teo and Ling, 2006). SCI will be used to measure the safety culture level of a building project, and CSI will be used to identify and evaluate the various safety control activities. CSI is a quantitative score that reflects the effectiveness of a construction company's safety management system. The CSI is based on the 3P+ I Model which is made up of four main factors: Policy Factor, Process Factor, Personnel Factor and Incentive Factor. SCI is a quantitative score that reflects the level of safety culture of a construction company. It acts as an objective measure of different sites for management and appraisal purposes.

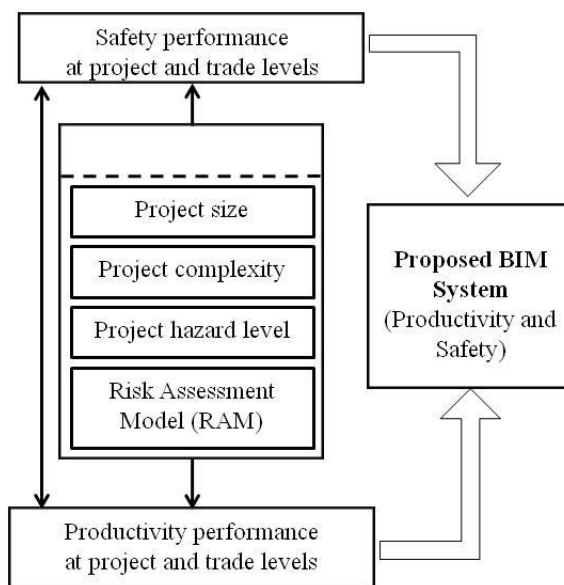

Figure 1: Conceptual Framework of the Study

METHODS

Empirical data will be collected through face-to-face interviews, an online questionnaire survey and case studies.

Preliminary Interviews

The objective of the preliminary interviews is to establish the baseline in terms of the industry's practice of productivity. It involves finding out current practices and procedures through the collection of information from various companies on their approaches. The interviewees include the key people from the public and private

sectors as well as the leaders of professional institutions and trade associations of the construction industry in Singapore.

The interview questions seek to find out the interviewees' current concerns about productivity and safety in general, companies' policies on productivity and safety, and companies' methods for measuring productivity. The interviewees are also asked about their awareness of various government policies and incentives on productivity and safety, the extent to which they have taken these up and their experiences in the application of the schemes. The interviewees are also asked for their views on enablers of, and obstacles to, safety and productivity improvement, as well as the link between safety and productivity. Finally, the interviewees are asked to express the opinions on the roles of subcontractors, suppliers, professional institutions and trade associations.

On BIM, the interviewees are asked about the level of BIM utilisation in the company; their opinions on the potential of BIM and its impact on productivity and safety. The interviewees are also asked for their views on the perceived benefits of BIM, safety and productivity.

Questionnaire

The questionnaire seeks to investigate issues including companies' policies and approaches with regard to productivity and safety, existing methods for measuring productivity and safety levels on projects, companies' experience with the relationship between productivity and safety and companies' knowledge and application of BIM.

The questionnaire is divided into five parts. The first part of the questionnaire consists of introductory questions to facilitate data classification. The first part is the only section in the questionnaire which has different contents according to the target respondents. The second to the fifth parts of the questionnaire use a five-point Likert scale. In the questions, the respondents are requested to indicate the level of effectiveness of the items in the statement; the extent of their agreement with the statement; and the importance or necessity, of the items or factors indicated in the statements.

The second part of the questionnaire consists of questions to evaluate the effectiveness of the implementation of a number of measures in improving the productivity level of the industry. It also seeks to assess the extent to which respondents agreed that a number of factors have contributed to low productivity on site and have become an obstacle to productivity measurement. It also seeks to assess the level of importance of a number of measures in enhancing productivity on site.

The third part of the questionnaire consists of questions to evaluate the implementation of construction safety in the company. It includes questions which seek to assess the extent to which respondents consider a number of factors to be necessary in determining the safety level on site. It also seeks to investigate the corporate practices with regard to safety.

The fourth part of the questionnaire seeks the respondents' opinion concerning the relationship between construction safety and productivity. It explores the level of respondents' agreement of the impact of a number of factors on productivity and safety.

The fifth part of the questionnaire seeks to investigate the extent of BIM application in the companies. It seeks to assess the extent to which respondents agree that a number of factors have been an obstacle to the use of BIM in the company. It also explores the potential of BIM for the improvement of productivity and safety in the construction industry.

The respondents of the questionnaire-based survey can be classified into two big groups: main contractors and consultants (Table 1). The target population for main contractors comprises companies that are registered with the BCA under registration heads CW01 (general building) and CW02 (civil engineering), with tendering limits of A1, A2, B1, B2, C1, C2 and C3. A total of 2,776 contractors were identified.

Consultants consist of architects, structural and mechanical and electrical (M&E) engineers, and quantity surveyors. The consultants were selected from the lists of members provided by the respective professional institutions in Singapore. A total of 1,142 consultants were selected. Hence, the total number of target respondents is 3,918.

Table 1: Population frame

Population frame	Identification method	Number of companies
Main contractors	Contractors under BCA registration heads: CW01 (general building) CW02 (civil engineering) with tendering limits: A1, A2 B1, B2 C1, C2, C3	171 308 2,297
Architects	Members of Singapore Institute of Architects (SIA)	377
Structural and M&E engineers	Members of Association of Consulting Engineers (ACES)	142
Quantity surveyors	Members of Singapore Institute of Surveyors and Valuers (SISV)	623
	Total	3,918

Statistical analysis will be performed to analyse the data collected and build the model. First, the reliability of the questions in the questionnaire for the study will be examined to determine internal consistency. Next, mean ratings will be calculated. ANOVA will be undertaken to determine whether the views from different group of respondents were similar. Finally, multiple regression and optimisation techniques will be employed.

Case studies

A huge volume of data on incidences, injury and fatality is required for risk quantification and risk analysis. Hence, a number of companies are being approached

to provide the necessary project case studies and practices on construction productivity, construction safety and BIM. Validation of the intelligent system will be carried out by collecting new sets of data, and comparing the actual data and predicted results.

SIGNIFICANCE OF RESULTS

This study provides knowledge of productivity and safety performance so as to assist the project team to manage construction safety and achieve productivity gain via the BIM approach. The theoretical originality of this research lies in the following possible findings: (1) the relationship between productivity and safety, (2) the impacts of BIM on the level of productivity and safety issues of construction projects, and (3) the integration of BIM functionality for the improvement of safety level and achievement of productivity growth for construction projects.

With BIM, construction project managers can plan site activities and safety programmes in ways to focus on the higher-risk trades and prioritise hazard mitigation strategies and intervention methods to make effective resource allocation decisions. The BIM technology can help construction stakeholders to manage tacit and explicit knowledge using context information. It can also provide an elastic environment to manage construction knowledge which is suitable to text-based knowledge. Furthermore, it discovers the know-how, relationships and practices that can be used to help to solve problems that might arise on construction sites.

The outcomes of the project will drive future research in this field in studying the best practices of the developed countries with better safety records to design comprehensive monitoring mechanisms on WSH risk, especially the near misses. It is vital to 'systematically collect and analyse statistics, information and situations on near misses' because it allows construction stakeholders to 'closely track the progress of WSH improvements and calibrate their interventions and policy responses to address the issues of concern' (WSHC, 2007). This can be a further stage of the study on safety in Singapore.

CONCLUSIONS

To move forward to the next stage of the research project, the research team is currently collecting the necessary data and information required to understand the relationship between safety and productivity and the use of BIM to enhance both. Currently, there are no tools for evaluating productivity and safety, which are regarded as the essentials for risk management. An effective measure or benchmark of productivity, safety and best practices are important ingredients for improving safety risk management. The synergised system should help to assess site safety and provide guidance in prioritising the safety management measures on construction sites.

The outcomes of the project will drive research on investigating the best safety practices and designing comprehensive monitoring mechanisms on Workplace Safety and Health (WSH) risks, and at the same, make the often necessary trade-offs between safety and other project performance criteria. For example, the potential to enhance safety while reducing cost and/or improving quality can be investigated. The use of BIM and allied technologies and systems in such tasks can also be explored further.

ACKNOWLEDGEMENTS

The authors gratefully acknowledge the funding received from the Workplace Safety and Health Institute (WSH Institute) of the Ministry of Manpower (MOM). We are also grateful to our collaborating organisations, the Building and Construction Authority (BCA) and Samwoh Corporation Pte Ltd, for their support.

REFERENCES

- Associated General Contractors of America (AGC) (2010) The contractors guide to BIM. Lincoln, Nebraska.
- Azhar, S (2011) Building Information Modelling (BIM): Trends, Benefits, Risks, and Challenges for the AEC Industry. "Leadership and Management in Engineering", 11(3), 241-252.
- Benjaoran, V and Bhokha, S (2010) An integrated safety management with construction management using 4D CAD model. "Safety Science", 48(3), 395-403.
- Building and Construction Authority (BCA) (2014a) "Building Information Modelling (BIM)". Singapore: BCA. Retrieved on 16 February 2014 from <http://www.bca.gov.sg/bim/bimlinks.html>.
- Building and Construction Authority (BCA) (2014b) "Construction Productivity and Capability Fund (CPCF)". Singapore: BCA. Retrieved on 13 February 2014 from <http://www.bca.gov.sg/CPCF/cpcf.html>.
- Building and Construction Authority (BCA) (2014c) "Enhancement of Construction Productivity and Capability Fund". Singapore: BCA. Retrieved on 13 February 2014 from http://www.bca.gov.sg/CPCF/others/CPCF_Enhancement.pdf.
- CEFRIO (2011) Improving Efficiency and Productivity in the Construction Sector through the Use of Information Technologies. CEFRIO, Canada.
- Economic Strategies Committee (2010) "Report of the Economic Strategies Committee". Singapore: Economic Strategies Committee.
- Gelisen, G. and Griffis, F. H. (2014) Automated Productivity-Based Schedule Animation: Simulation-Based Approach to Time-Cost Trade-Off Analysis. Journal of Construction Engineering and Management, 140(4), 1-10.
- Gong, J and Caldas, C H (2011) An object recognition, tracking, and contextual reasoning-based video interpretation method for rapid productivity analysis of construction operations. "Automation in Construction", 20(8), 1211-1226.
- Gu, N and London, K (2010) Understanding and facilitating BIM adoption in the AEC industry. "Automation in Construction", 19(8), 988-999.
- Ku, K. and Mills, T. (2008) Research needs for Building Information Modeling for construction safety. In: Sulbaran, T. and Sterling, C. (Eds.), "The 44th ASC Annual Conference", 2-5 April. Auburn.
- Ministry of Manpower (MOM) (2008) "Annual Report". Singapore: MOM. Retrieved from http://www.mom.gov.sg/Documents/safety-health/reports-stats/OSHD-AR2008/OSHD%20AR%202008_Part%203.pdf.
- Lee, Y. S. (2014) Speech on Improving Construction Productivity. Singapore. Retrieved from <http://app.mnd.gov.sg/Newsroom/NewsPage.aspx?ID=5237&category=Speech&year=2014&RA1=&RA2=&RA3=>

- Ofori, G., Teo, E. A. L. and Tjandra, I. K. (2011a) Developing the Construction Industry: A Decade of Change in Four Countries. In: Laryea, S., Leiringer, R. and Hughes, W. (Eds.), "West Africa Built Environment Research (WABER) Conference", 19-21 July. WABER, 3-16.
- Ofori, G., Teo, E. A. L. and Tjandra, I. K. (2011b) Safety in Construction in Singapore: Policies, Assessment and Further Development. In: "Proceedings of the CIB W099 Conference 2011: Prevention - Means to the End of Safety and Health Injuries, Illnesses, and Fatalities", 24-26 August. CIB.
- Rajendran, S. and Clarke, B. (2011) Building Information Modeling: Safety Benefits and Opportunities. *Professional Safety*, October, 44-51.
- Smith, D (2007) An introduction to Building Information Modelling (BIM). "Journal of Building Information Modelling", Fall, 12-14.
- Smith, D K and Tardif, M (2009) "Building Information Modelling: A Strategic Implementation Guide for Architects, Engineers, Constructors, and Real Estate Asset Managers". New Jersey: John Wiley and Sons.
- Teo, E. A. L. and Ling, F. Y. Y. (2006) Developing a model to measure the effectiveness of safety management systems of construction sites. *Building and Environment*, 41, 1584-1592.
- Workplace Safety and Health Council (2007) "WSH 2015: A strategy for workplace safety and health in Singapore". Singapore: WSH Council.
- Workplace Safety and Health Institute (2013) "Workplace Safety and Health Report, January to June 2013". Singapore: WSH Institute.
- Zhang, S., Teizer, J., Lee, J., Eastman, C. and Venugopal, M. (2013) Building Information Modeling (BIM) and Safety: Automatic Safety Checking of Construction Models and Schedules. *Automation in Construction*, 29, 183-195. Zhang
- Zuppa, D., Issa, R. and Suermann, P. (2009) BIM's Impact on the Success Measures of Construction Projects. *Computing in Civil Engineering*, 503-512.

A SYSTEMATIC LITERATURE REVIEW OF CURRENT RESEARCH ON PREVENTION AND PROTECTION OF FALL FROM HEIGHT

Lili Poon, Yang Miang Goh⁹¹, and Zhipeng Zhou

Department of Building, School of Design and Environment, National University of Singapore, 119260, Singapore

Prevention and mitigation of fall from height (FFH) has been researched in medical, human factors, engineering, psychology, and management disciplines. However, there is a tendency for these disciplines to be isolated and studies are typically narrowly scoped to address specific issues. This paper aims to systematically review fall from height academic research between 2003 and 2012, so as to compile useful findings for the construction industry and future research. A conceptual framework based on the Modified Loss Causation Model (MLCM) is developed to facilitate a holistic review of the current state of knowledge. An extensive search was conducted based on PubMed, Web of Knowledge (Web of Science) and ScienceDirect and 131 studies were selected for further analysis. The 131 papers were analyzed based on geographical location, industry sector, keywords and study type. It is observed that current research tend to focus on loss of balance and fall arrest systems. The key findings from the systematic literature review are summarized according to the conceptual framework and conflicting findings of different research are highlighted. Practical recommendations were provided for practitioners for improving the safety of work-at-height.

Keywords: literature review, fall from height, modified loss causation model, fall arrest system

INTRODUCTION

Work-at-height (WAH) is defined as “working in any place, including a place at or below ground level while at the same time including access and egress from such working place where a person could possibly fall a distance liable to cause personal injury” (Health and Safety Executive (HSE), 2013). As stated by the Workplace Safety and Health Council of Singapore (WSHC) (2011), a worker may be susceptible to risks of fall-from-height (FFH) while working at various types of platforms such as boom lifts, openings, excavation ditches, scaffolds, climbing work platforms, open sides and roofs. FFH accident has been a leading cause of injury in the construction industry in many regions including Singapore, New Zealand, Hong Kong, Taiwan, Kuwait, the United States (US), Israel and so forth (Tan, 2007; Bentley et al., 2006; Chan et al., 2008; Kartam et al., 1998; Lipscomb et al., 2004; Yanai et al., 1999). Not only do FFH accidents cause human suffering, substantial economic losses associated with fall injuries were also reported worldwide (Lockhart et al., 2005). In US, the

⁹¹ bdggym@nus.edu.sg

annual direct cost of occupational injuries due to falls has been estimated to be in excess of 6 billion US dollars (Courtney et al., 2001).

Due to the risk posed by FFH accident, many researchers around the world have been studying the problem of FFH. However, the large number of FFH publications made it hard for researchers and practitioners to have a clear overview of the current research. Although there were studies reviewing the FFH literature (Hsiao and Simeonov, 2001; Hsiao et al., 2008; Hu et al., 2011), these reviews were focused on specific topics. Hence, this study takes a holistic approach and aims to identify useful findings for the industry and propose possible improvements to the current safety guidelines and instructions.

METHODS

Literature Search

The academic databases, ScienceDirect, PubMed and Web of Knowledge were searched comprehensively. The search strategy used a combination of two sets of search terms connected using an “AND”. The terms in each set of search terms were combined using the “OR” connector. The first set of search terms comprised of eight terms (see Table 1) focusing on different situations or locations that FFH could possibly happen. The second set of search terms consisted of 42 key terms identified based on the framework provided by the Modified Loss Causation Model (MLCM) (Chua and Goh, 2004) (see Table 2). Furthermore, to ensure the recency of the results, the search was limited to articles published between 2003 and 2012. After merging the search results and removing duplicates, 1,078 studies remained.

Table 1. Group one search terms used for literature research

No.	Group one search terms
1	Falls from height(s)/ to lower level
2	Falls from elevation(s)/ elevated surface(s)/ elevated platform(s)
3	Falls through roof(s)/ inclined surface(s)
4	Falls through opening(s)/ hole(s)/ skylight(s)
5	Falls from formwork(s)/ provisional structure(s)
6	Falls from an open side
7	Falls from scaffold(s)
8	Fall from aerial lift(s)/ scissor lift(s)

Table 2. Group two search terms used for literature research

No.	Group two search terms
1	Hazard(s)
2	Cause(s)/ causal factor(s)/contributing factor(s)
3	Risk(s)/fall risk(s)
4	Engineering control(s)/risk control measure(s)/ intervention(s)
5	Guardrail(s)/Handrail(s)
6	Accident prevention
7	Personal protection equipment/personal protection system(s)

8	Fall arrest system(s)
9	Fall protection system(s)
10	Anchorage/anchor point
11	Energy absorber(s)/shock absorber(s)
12	Fall restraint
14	Lanyard
15	Lifeline(s)
16	Harness/body harness
17	Safety net(s)
18	Balance/imbalance/stability
19	Body control/postural control/postural sway
20	Slip(s)
21	Trip(s)
22	Worker's behaviour(s)/safety behaviour(s)/unsafe behaviour(s)
23	Perception(s)/risk perception(s)
24	Training(s)/safety program
25	Work practice(s)/job practice(s)/on-site practice(s)
26	Safety culture/safety climate
27	Safety attitude
28	Regulation(s)/Occupational safety standard(s)
29	Supervision/inspection
30	Safety compliance
31	Hazard identification/audit(s)
32	Risk assessment
33	Safety management system(s)
34	Construction industry/building industry
35	Construction worker(s)/labourer(s)
36	Age
37	Fatigue
38	Experience
39	Management/ management commitment/management attitude
40	Motivation
41	Work pressure/stress/productivity pressure/time pressure
42	Co-worker(s)/workmate(s)/peer pressure

Literature Selection

The relevance of the 1,078 articles was examined by screening the titles, keywords and abstracts. For articles where the information in the article title, keyword and abstract was insufficient, the full text was reviewed. At this stage, 250 citations were

classified as directly relevant and the full text articles of these articles were retrieved and further examined based on five additional criteria described below:

1. Context: Articles should be related to the construction industry. However, this does not mean that the data collected is construction specific.
2. Exposure: Articles related to fall-from-height accident in workplace setting were included while non-occupational fall was excluded.
3. Outcome: Articles focusing only on outcomes of FFH accidents including emergency response, injuries and day leave from work were excluded.
4. Language: Only articles in English were included.
5. Publication type: Only peer-reviewed journal articles were included. Book chapters, dissertations, and conference proceedings were excluded.

RESULTS

Overview

In total 131 publications met the selection criteria. The distribution of the year of publication is depicted in Fig.1.

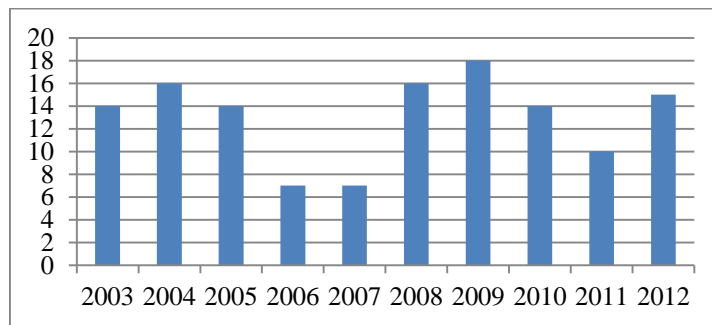

Fig.1. Year profile of literature publications

The 131 papers originated from eighteen different regions covering four continents. The distribution of the regions is illustrated in Table 3.

Table 3. Geographical distribution

Region	Australia	Canada	China	Denmark	Hong Kong	Israel	Japan	Korea	New Zealand
Occurrence	5	5	4	2	7	3	1	2	1
Region	Poland	Spain	Sweden	Switzerland	Taiwan	Thailand	The Netherlands	United Kingdom	United States
Occurrence	9	6	1	1	6	2	2	3	71

Industry or sector studied

Table 4 summarized the industry or sector studied in the articles. Twenty-six studies have taken a general approach to report data in a generic manner whereby such findings can be widely applicable to various aspects. Eight of the papers were focused on other industries, but they have findings directly relevant to the construction industry. The remaining papers were specific to the construction industry.

A larger fraction of papers (74 out of 131 papers) studied construction industry as a whole. While 20 papers studied residential construction sectors, signifying the risk of fall accident in the residential sector. Furthermore, roofing work appeared to be a key concern in the residential construction sector. It can be observed that there were fewer studies concerning commercial and civil sector and repair and maintenance. This suggests that sector-specific research especially in commercial and civil sectors may require more attention.

Table 4. Industry and sector studied

Industry or sector studied	Frequency
General	26
Specific-Not construction industry	8
Specific-Construction industry	97
All sectors	74
Residential sector (9 papers focus on roofing)	20
Commercial and civil sector	1
Repair and maintenance sector	2
Total	131

Study type

Laboratory experiment was the most frequently used research method in the majority of papers reviewed. Most of the laboratory experiments were studying worker's loss of balance and fall arrest systems (FAS). The summary of research methods for the selected papers is illustrated in Table 5.

Table 5. Research methods

Research type	Frequency
Analytical model based on empirical data	7
Archived data from government or research institutes database and compensation claims	17
Laboratory experiment	63
Interview and focus group	16
Survey and questionnaire	33
Site observation and audit	10
Total	146*

*Note: The sum is not equal to total numbers of included papers as some papers may fall in more than one category.

Keywords analysis

Keywords analysis is a useful tool for reflecting the topics of discussion. There were in total 860 keywords included in this analysis. After grouping the keywords with similar meanings and implications, 25 keywords with the highest repetitions are listed in Table 6.

Table 6. The most frequently used keywords

Classification	Frequency	Percentage
Fall accident(s)	68	11.8%
Construction industry	58	10.1%
Sense of balance	54	9.4%
Occupational/construction safety and health	49	8.5%
Fall protective device/PPE	48	8.3%
Injury/injuries	31	5.4%
Manpower/worker(s)	26	4.5%
Prevention	26	4.5%

Human/human engineering	21	3.6%
Slip(s)	18	3.1%
Equipment design/facility design	15	2.6%
Safety climate/safety culture	15	2.6%
Risk(s)	15	2.6%
Roof(s)	15	2.6%
Accident(s)	14	2.4%
Ladder safety	14	2.4%
Muscle fatigue	14	2.4%
Psychological issue	12	2.1%
Adult	10	1.7%
Male	10	1.7%
Behavioural issue	9	1.6%
Body factor	9	1.6%
Fatality/fatalities	9	1.6%
Regulation(s)	8	1.4%
Female	8	1.4%

It is not surprising that ‘sense of balance’ (9.4%) is one of the most frequently cited keywords. ‘Fall protective device/ PPE’ (8.3%) also had a relatively high frequency. It is interesting to observe that 2.8% of the papers are focused on ‘equipment design/facility design’. This suggests a growing interest in reducing the risk of falls from height through improving current design. Safe engineering design is a preferred over fall protective devices, according to the hierarchy of control. The keyword analysis shows that ‘roof(s)’ (2.7%) and ‘ladder safety’ (2.6%) are key areas of research in FFH studies.

FURTHER ANALYSIS

Analysis Framework

The MLCM proposed by Chua and Goh (2004) was adapted to provide a framework to further categorise the 131 papers. The framework contains five main categories including situational variables, incident sequence, immediate causes, safety management system (SMS) failures and underlying factors. The focus areas and findings of the 131 papers were then classified in accordance to the framework to profile the distribution of current research in FFH.

The first category is the *situational variables*, which identifies the critical characteristics of the work context in which FFH accident can occur. Some examples of situational variables include work executed on elevated surfaces, openings and skylights, floor slab formwork erection stage, roofs and roof trusses, low elevations, ladders and scaffolds.

The second category examines the sequence of events in a FFH accident. The *breakdown event*, which typically takes place when a worker loses his/her balance at height. Worker’s loss of balance can be a result of various factors such as poor manual handling method, working posture, footwear, inclination of work surface, other worksite conditions, improper usage of PPE and so forth. After the *breakdown event*, *pre-contact* measures (prior to worker impacting a surface or object) should be in place to inhibit or minimize injuries after a fall has been initiated. Such measures mainly include fall arrest system (FAS). Due to time constraint of this review, other events in a typical FFH incident sequence (in accordance to the MLCM), including *contact event*, *post-contact measures* and *consequences*, were not included in this study.

The third category, *immediate causes*, consists of two components. The first component refers to unsafe behaviour of workers, such as failure to wear PPE. The second component involves personal factors leading to unsafe acts. Personal factors include, for instance, safety attitude and previous accident involvement, risk perception, experience, motivation and so forth.

The fourth category refers to a lack of measures or inadequate measures in SMS. For instance, inadequate safety management, risk assessment and hazard audits, insufficient provision of PPE and training.

The fifth category, underlying factor, comprises of two components, namely job factors and organizational factors, respectively. Job factors refer to factors related to task definition and execution. For instance, supervision and inspection, task nature, project attributes and legal enforcement. On the other hand, organizational factors are recognized to have effects in influencing organization's SMS. Such factors comprise of firm size, work pressure, management commitment to safety climate and so forth. It is noted that personal factors and underlying factors are usually not industry-specific and research findings can potentially apply across industries.

Discussion

The 131 papers were classified into the different categories of the framework based on their overall objectives and key findings. Some studies may be classified into more than one category, depending on the nature of the research finding. According to Fig.2, 'incident sequence' has distinguished itself to be the category with the highest percentage (28%). This is because this category includes prevention measures, worker's loss of balance and pre-contact measures, which are commonly discussed in the literature. 'Underlying factors' (26%) and 'immediate cause' (20%) also have relatively high frequency.

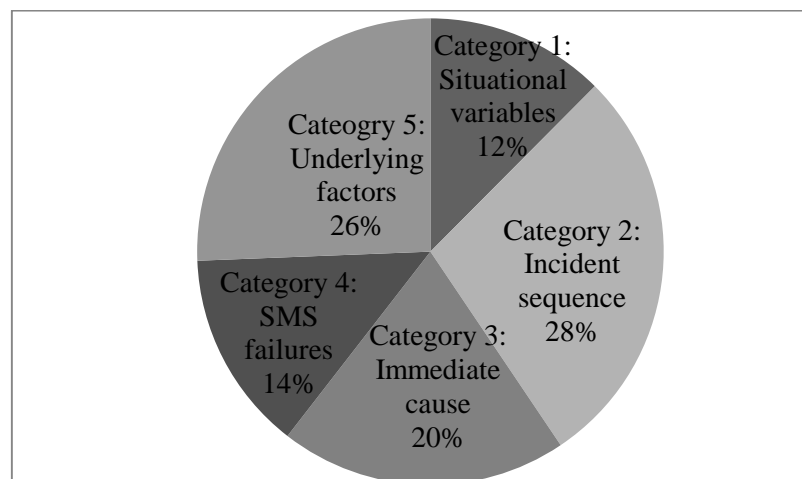

Fig.2. Categories of publications based on MLCM

Table 7 shows the distribution in greater detail. In the category of 'incident sequence', 39 studies were about loss of balance. As argued by Hsiao and Simeonov (2001), most occupational falls are commonly initiated by imbalance, slips and trips. Thus, the relatively large number of papers is justifiable. The 39 papers determined various factors affecting balance of workers including working environment, work execution, physiological issue and psychological factor. The review found that current research

has generally shown a relatively comprehensive picture for the factors related to balance issue.

However, it was observed that prevention measures did not receive much attention in the studies reviewed. Although guardrails were frequently discussed, the number of such publications remained significantly low. Additional research efforts should be given to these prevention measures (or engineering controls). Ironically, despite engineering controls being acknowledged as a more effective and sustainable form of risk control, there were significantly more research on use of PPE to reduce risk of FFH accidents. Among the studies on PPE, fall arrest system (FAS) appears to be the main area of focus, possibly due to the heavy reliance on FAS on worksites.

Table 7. Detailed breakdown of literature according to framework findings

Framework topic	Frequency
<i>Category 1: Situational variables</i>	35
Openings and skylights	7
Floor slab formwork erection stage	3
Roofs	4
Low elevations	4
Scaffolds	7
Ladders	10
<i>Category 2: Incident sequence</i>	65
<i>Component 2a. Prevention measures</i>	4
General approach: active measures for various situations	2
Guardrails	2
<i>Component 2b. Breakdown event – Worker's loss of balance</i>	39*
Heights simulation/ Virtual height effects	4
Worksite conditions	9
Sensory and visual interaction	5
Effects of inclination	4
Physique and sex	2
Psychological effect: perception of height	2
Localized muscle fatigue and role of ankle	6
Load handling	7
Posture and foot placement	3
Workload and duration	7
Footwear effects	2
Influences of Personal Protective Equipment (PPE)	2
<i>Component 2c. Pre-contact measures</i>	22
Fall arrest system (FAS)	20
Safety nets	1
Hands	1
<i>Category 3: Immediate cause</i>	40
<i>Component 3a. Unsafe behaviours</i>	5
Failures to use PPE	5
<i>Component 3b. Personal factors leading to unsafe behaviours</i>	35*
Safety attitude and previous accident involvement	7
Risk perception	11
Working Experience	15
Age	6
Motivation	3
Drinking habit	3
Language ability and cultural factor	3
Self-esteem	3
<i>Category 4: SMS failures</i>	33
<i>Component 4a. Lack of measures or inadequate measures</i>	33*
SMS	5

Risk assessment and fall hazard audits	9
Training	22
Provisions of PPE	3
<i>Category 5: Underlying factors</i>	48
<i>Component 5a. Job factors</i>	17*
Task nature	4
Project attributes	4
Legal enforcement	6
Supervision and inspection	4
<i>Component 5b. Organizational factors</i>	31*
Firm size	5
Co-worker's influences	7
Work pressure	12
Job communication	10
Management's commitment to safety climate	18

*Note: The sum is not equal to total numbers of included papers, as some papers may fall in more than one category.

Among the various immediate causes, working experience is the most frequently mentioned factor. Consistent with previous research (Hu et al., 2011), the second frequently discussed factor is risk perception of workers. It is noted that Larsson et al. (2008) highlighted motivation as a key mediator which can influence safety behaviour direct and indirectly. For instance, despite the provision of equipment and adequate training, workers continue to engage in unsafe behaviours due low motivation (Kines, 2003). It is reasonable to argue that the key to safety behaviours of workers largely lies in workers' motivation. As there are relatively few publications on motivation of safety behaviours in the construction industry, it is an area of worthy of further research.

In terms of safety management, there are a considerable number of publications focusing on training provided to workers. The significance of training and its effectiveness were also reinforced in previous literature (Chan et al., 2008; Fang et al., 2006; Huang and Hinze, 2003; Martin et al., 2009; Sa et al., 2009).

In the category of *underlying factors*, it was observed that *job factors* received relatively less emphasis compared to *organizational factors*. On the other hand, among the contributing factors in organizational factors, management commitment to safety climate was the main emphasis. This finding is consistent with previous literature that a management commitment to safety produces safer on-site behaviours (Fung et al., 2005; Larsson et al., 2008; Mohamed et al., 2009).

Recommendations

Training

Previous studies indicated a common problem that training curriculum fails to meet the need of workers due to its discrepancies with onsite practices (Lipscomb et al., 2008; Kaskutas et al., 2012). Thus, there is a need to evaluate the effectiveness of WAH training in improving safety behavior of workers working at height. Besides training courses, other forms of training, such as coaching by experienced workers (Kines et al., 2010; Hung et al., 2012) should be developed.

Besides training workers on WAH knowledge and skills, there is also a need to ensure that construction foremen have the ability to communicate safety messages related to WAH effectively (Kaskutas et al., 2012). Furthermore, it is interesting to note that

workers' perception about the importance of safety training may also be used as an indicator of actual levels of safety behaviour (Cooper and Phillips, 2004).

Potential improvements on safety guidelines

Governments or agencies of different countries have collaborated to improve FFH problem by developing a number of guidelines and toolkits for industry. These guidelines include a wide range of topics such as design for safety, fall protection plan, risk management, risk control measures, inspection and maintenance, training and supervision, and good practices for working at various elevated surfaces such as roofs and ladders. There are also some toolkits such as WAH checklist and planning tool provided for industry players to evaluate their worksite safety compliance and to recommend improvements required.

It is seen that the construction industry has been focusing on the technical aspects of fall protection measures. However, it is observed that the industry demonstrates insufficient efforts to address worker's loss of balance despite significant research in this area. Useful findings regarding sense of balance from current research were seldom utilized by the industry to prevent falls from height. As falls are common to be initiated by imbalance, slips and trips conditions, industry should provide guidelines to enhance worker's balance at work. Industry may also contemplate improving work environment by establishing better housekeeping policy, developing good practices for posture, foot placement and load handling, setting appropriate work-rest cycles, selecting proper footwear designs and building visual cue for stabilizing effects to improve WAH safety.

New technology and design

The current literature has demonstrated a trend to enhance safety through improving workplace design. This is a promising research agenda and future research should aim to develop innovative technology to help to reduce workers exposure to WAH hazards.

CONCLUSIONS

FFH accident is a persistent problem in the construction industry, and it has contributed to a high percentage of fatality. In order to provide an overview of the current research in the area of FFH, this study systematically reviewed the relevant literature the past 10 years. In addition, a conceptual framework based on an accident causation model is also used to understand the distribution of the current research. Recommendations involving in training, safety guidelines, and new technology and design, were proposed for improving FFH issue in construction industry. It is believed that further research and improvements to these aspects not only helps to save workers from suffering from FFH injuries but also prevent substantial economic losses associated with falls.

REFERENCES

- Bentley, T. A., Hide, S., Tappin, D., Moore, D., Legg, S., Ashby, L., and Parker, R. (2006). Investigating risk factors for slips, trips and falls in New Zealand residential construction using incident-centred and incident-independent methods. *Ergonomics*, 49(1), 62-77.

- Chan, P. C., Wong, K. W., Chan, W. M., Yam, C. H., Kwok, W. K., Lam, W. M., and Cheung, E. (2008). Work at height fatalities in the repair, maintenance, alteration, and addition works. *Journal of Construction Engineering and Management*, 134(7), 527-535.
- Chua, D. K. H., and Y. M. Goh. (2004). Incident causation model for improving feedback of safety knowledge. *Journal of Construction Engineering and Management*, 130(4), 542-551.
- Cooper, M. D., and Phillips, R. A. (2004). Exploratory analysis of the safety climate and safety behavior relationship. *Journal of Safety Research*, 35(5), 497-512.
- Courtney, T. K., Sorock, G. S., Manning, D. P., Collins, J. W., and Holbein-Jenny, M. A. (2001). Occupational slip, trip and fall-related injuries-can the contribution of slipperiness be isolated? *Ergonomics*, 44(13), 1118-1137.
- Fang, D., Yang, C., and Wong, L. (2006). Safety Climate in Construction Industry: A Case Study in Hong Kong. *Journal of Construction Engineering and Management*, 132(6), 573-584.
- Fung, H., Tam, M., Tung, F., and Man, K. (2005). Safety cultural divergences among management, supervisory and worker groups in Hong Kong construction industry. *International Journal of Project Management*, 23(7), 504-512.
- Health and Safety Executive (HSE). (2013). Guidance: work at height (WAH). <http://www.hse.gov.uk/toolbox/height.htm>
- Hsiao, H., and Simeonov, P. (2001). Preventing falls from roofs: a critical review. *Ergonomics*, 44(5), 537-561.
- Hsiao, H., Simeonov, P., Pizatella, T., Stout, N., and Weeks, J. (2008). Extension-ladder safety: Solutions and knowledge gaps. *International Journal of Industrial Ergonomics*, 38(12), 959-965.
- Hu, K., Rahmandad, H., Smith, L., and Winchester, W. (2011). Factors influencing the risk of falls in the construction industry: a review of the evidence. *Construction Management and Economics*, 29(4), 397-416.
- Huang, X., and Hinze, J. (2003). Analysis of construction worker fall accidents. *Journal of Construction Engineering and Management*, 129(3), 262-271.
- Hung, H., Winchester, W., Smith, L., Kleiner, M., and Mills, H., (2013). Identifying fall-protection training needs for residential roofing subcontractors. *Applied Ergonomics*, 44(3), 372-380.
- Kartam, N. A. K., Nabil A., and Bouz, R. G. (1998). Fatalities and injuries in the Kuwaiti construction industry. *Accident Analysis and Prevention*, 30(6), 805-814.
- Kaskutas, V., Dale, M., Lipscomb, H., and Evanoff, B. (2012). Fall prevention and safety communication training for foremen: Report of a pilot project designed to improve residential construction safety. *Journal of Safety Research*, 44(2), 111-118.
- Kines, P. (2003). Case studies of occupational falls from heights: Cognition and behavior in context. *Journal of Safety Research*, 34(3), 263-271.
- Kines, P., Andersen, S., Spangenberg, S., Mikkelsen, L., Dyreborg, J., and Zohar, D. (2010). Improving construction site safety through leader-based verbal safety communication. *Journal of Safety Research*, 41(5), 399-406.
- Larsson, S., Pousette, A., and Torner, M. (2008). Psychological climate and safety in the construction industry-mediated influence on safety behaviour. *Safety Science*, 46(3), 405-412.

- Lipscomb, J., Dale, M., Kaskutas, V., and Evanoff, B. (2008). Challenges in residential fall prevention: Insight from apprentice carpenters. *American Journal of Industrial Medicine*, 51(1), 60-68.
- Lipscomb, J., Glazner, J., Bondy, J., Lezotte, D., and Guarini, K. (2004). Analysis of text from injury reports improves understanding of construction falls. *Journal of Occupational and Environmental Medicine*, 46(11), 1166-1173.
- Lockhart, E., Grönqvist, R., and Chang, R. (2005). Prevention of fall-related accidents. *Safety Science*, 43(7), 355-357.
- Martin, J. E., Rivas, T., Matias, J. M., Taboada, J., and Arguelles, A. (2009). A Bayesian network analysis of workplace accidents caused by falls from a height. *Safety Science*, 47(2), 206-214.
- Mohamed, S., Ali, H., and Tam, V. (2009). National culture and safe work behaviour of construction workers in Pakistan. *Safety Science*, 47(1), 29-35.
- Sa, J., Seo, C., and Choi, D. (2009). Comparison of risk factors for falls from height between commercial and residential roofers. *Journal of Safety Research*, 42(3), 229-230.
- Tan, K. Y. (2007). Overview of OSH accident statistics and trends involving falls from heights between 2002 to Nov 2006. Ministry of Manpower.
- Workplace Safety and Health Council. (2011). Workplace safety and health report 2011. Workplace Safety and Health Council.
- Yanai, O., Goldin, L., Kugel, C., and Hiss, J. (1999). Occupational fatalities in Israel. *Journal of Clinical Forensic Medicine*, 6(3), 129-132.

LEADERSHIP - A NEGATION OF AGENCY OR AN OPPORTUNITY TO DEVELOP AUTONOMOUS ACTION FOR WORKPLACE SAFETY

Philip McAleenan⁹² and Ciaran McAleenan⁹³

¹Philip McAleenan 1 Expert Ease International, Downpatrick BT30 6HB, N.Ireland

²Ciaran McAleenan 2 School of the Built Environment University of Ulster, Jordanstown campus, Shore Road, Newtownabbey BT37 0QB, N.Ireland

The full development of safety or the achievement of safe progress onsite requires that leadership, as a catalyst, is relinquished in favour of the collective agency of the mature reasoning group, whether the design team or the onsite works teams. The claim to leadership is valued as it confers authority on the decisions, pronouncements and actions of those regarded as leaders. With it comes respectability and an expectation that those not in the leadership position will defer to the authority of the leading opinion. In some instances the cloak of leadership provides and is actively used as a protective barrier against objections and opposition. The general concept of leadership is multifaceted and in common parlance has many uses and meanings, from its application to those who are decision makers, to those holding office who assume the role of leader by dint of said office. In some cases leadership is assumed or assigned to those with ownership of or control over large scale enterprises. Intellectual or thought leadership is claimed by other institutions on the basis that they have more members or have greater recognition than comparable bodies. In many instances leadership is a form of management; authority to guide and direct work processes posited as leadership. Leadership has the potential to negate (autonomous) agency, and this is crucial to understanding the limited role that it should have in human affairs in the sphere of occupational health and safety where the decision making capacity of competent workers may be compromised by the overriding decisions of 'safety-leaders' on the periphery of or outside of particular design and construction activities. The full development of an idea or achievement of progress requires that leadership as a catalyst is relinquished in favour of the collective agency of a mature reasoning body. This paper critiques the current discourse on leadership concepts prevailing in the built environment today, arguing that the imposition of a 'safety-leader' negates autonomy and explores how treating leadership as a function, which transfers to those most suited to exercise it, presents the opportunity to develop autonomous actions for workplace safety.]

Keywords: health and safety, human resource management, leadership, organizational culture.

⁹² expertease@confinedspaces.com

⁹³ c.mcaleenan@ulster.ac.uk

ASPECTS OF LEADERSHIP HIERARCHIES

The professional and academic discourse on leadership is substantial and encompasses a range of conflicting theoretical perspectives (Spoelstra 2013, Eacott 2014) from how it is to be defined to whether leaders are born or made (Mostovicz et al 2009), where it is to be found (Kumar 2012) to what role it has in modern society (Chari 2012, Lowder n.d.). A brief examination of a few of the different uses to which the term is applied illustrates the complexity of the issue.

In the political sphere the claim leadership is made on the basis of politicians having 1) have more votes than their opponents and 2) they have been voted into office by the electorate. In a survey of business managers prior to the 2010 general election in the UK the ILM concluded that “leadership matters, particularly in politics, where it builds consensus in the party, balances competing agendas and ultimately wins elections”, (ILM 2010). This latter point is however a conflation of electoral politics and voting intentions with the electorate's desire to be led by those they vote for and indeed on the basis of the 5 dimensions of leadership the ILM used to determine the “Leadership Quotient” the 3 main party leaders scored rather low compared to other world “leaders” such as Barack Obama and Angela Merkel, nor did the leadership quotient reflect the positions of the three parties in the election.

The referral to Prime Ministers and Presidents as world leaders is based as much if not more on their decision making roles on behalf of their respective countries as it is on their personal share of the vote and their popularity. This conflates their role with the notion that their fellow nationals will follow or agree with their decisions or where the nation are being led. The conflation of decision making roles or positions with leadership is also found in industry where CEOs and senior management are similarly regarded as leaders and in the recruitment process qualities that make up leadership are central to decisions on whether to appoint or not (Fresh Minds, 2010).

It is the case that particular decisions by politicians and CEOs take the country/organisation in a particular direction, but this is not necessarily leadership. Such decision makers have the power and authority to take the country/ organisation along particular routes regardless of the support that they may have or not for the decision. The power relationship between “leader” and “follower” is not often central to the discourse but is evident within the terminology of differing theories; thus whether the leader, as in employer/ manger, controls the follower/ employee through a basic leader-member-exchange (LME) relationship (you do the work I want you to do and I will pay you a wage) (Tummers and Knies 2013) or in a transformational leadership approach the leader support and encourages the growth of subordinates to possibly in turn become leaders/ managers in the company/ organisation, (Latour and Rast 2004) or at least to enjoy their position and be supportive of the company, (Reid n.d.) the relationship is always one of power, the “followers” are not or not fully equal to the “leader”.

These power relationships are expanded in the managerial structures established by organisations and the role or function that individuals are assigned in those structures. Managers, even supervisors are expected to have leadership qualities in order to ensure that the workforce of the 21st century is well managed and that the companies continue to compete successfully in the market, (ILM 2012, Conch and Moon 2010). Part of this is the role that health and safety plays in the success of a company and part of the safety discourse centres on safety leadership and the role of the safety leader,

including who is the safety leader. Legislation in the UK mandates companies with boards to appoint a member of the board to have responsibility for ensuring that safety is incorporated into board reports and discussions, thus in the context of the above, ensuring that the leaders of the company are leading safety. The Institution of Occupational Safety and Health (IOSH) views transformational leadership as being more effective in achieving accident prevention and a reduction in unsafe behaviours by employees (Conch and Moon 2010) because they engender trust and respect from employees citing a positive relationship between supervisor's safety leadership styles and employees' safety behaviour.

In industry the position of leader and follower parallels the relationships that people have to the means of production. Put simply, you own the company you have the authority to decide how it is to be run and who does what, fundamentally an LME relationship without any sophistication, though in practice it has become much more sophisticated on the back of management and leadership theory. Emergent perspectives on how companies should behave challenge such unrefined approaches to directing and managing organisations and ethical leadership is being promulgated as central to what a leader does (Kumar 2012, Chari 2014, May and Pardey 2013). Ethical leadership theory developed out of the failures of large corporations in the early 2000s, failures that were the result of corruption and illegal practices in the financial world, and ultimately the banking and housing crises that led to the 2008 crash and recession. Organisations, such as the International Labour Organisation (ILO), recognised that a recession, particularly if it was to be extended, would lead to a decrease in good health and safety practice resulting in more workplace fatalities and injuries and warned of this at the World Congress on Occupational Health and Safety (OSH) in 2008 (McAleenan and McAleenan 2009b).

Positions of authority based on knowledge and expertise confers leadership status on some, even in situations where the individual is not proactively developing a leadership role or function. This happens when the idea or knowledge that an individual has gains wider support from others who take up those thoughts with the intention of putting them into practice or in some instances developing them further. There is no doubt that when an idea is published there is some element of wanting others to take it up but without an active programme of subordinating followers to the originator's ongoing thoughts on the matter, leadership here is defined primarily by the nature and actions of the followers.

The expert as a leader, active or passive, is not a new concept but Thought Leadership is. Leaders Direct (2014) defines it as being "radically different from traditional top-down leadership. It can be directed up as well as down or sideways, has nothing to do with position or managing people, is the basis of innovative change and is egalitarian because it can shift rapidly from one person to another". In this respect they state that it is not something that can be monopolised yet it is nonetheless an aspiration or an objective that some organisations strive for and in the process it becomes commodified; IOSH for example views the provision of high quality guidance as a key part of the organisation's thought leadership and corporate social responsibility activities.⁹⁴

⁹⁴ IOSH. Membership Advisory Panels, <http://www.iosh.co.uk/Site-Search.aspx?terms=%22thought%20leadership%22> accessed 31 January 2014

THE NECESSITY OF AGENCY

The idea that the concept of leadership means in some instances to guide and direct, in others cases to be to the fore or to be the best in the field, and in still others to be in advance of others who willingly follow, has merit, but limited in that for much of the time what is seen as leadership is in effect aspects of managerialism, that is people in senior positions in organisations who are charged with an objective that requires they organise others in an appropriate manner to achieve those objectives. It does not necessarily require that those who carry out the tasks essential to achieve the objective are in agreement with the objective or are supporters of those senior to them, i.e. the necessary leader/ follower dynamic is not met.

Fundamentally, when the concept is analysed at its core lies the notion that leadership involves,

- Something/someone that others are willing to adopt or follow,
- Those who, voluntarily, are willing to follow, and
- The surrender of the function of leadership when the above conditions no longer apply.

This latter point is often absent from the leadership discourse, though transformational leadership recognises a function of the leader as a cultivator of successors or those who would be partner leaders (Latour and Rast 2004, Reid n.d.). It is a necessary adjunct to the first two components and should the function of leader remain when one or both of the are removed, then leadership transforms into hierarchical authority and one of the number of forms discussed above.

Without these elements leadership as generally perceived has the potential to negate (autonomous) agency, whether of the individual or the team. Agency is central to competence (McAleenan and McAleenan 2009a, 2009b) in as much as the competent person, constrained in his ability to make decisions within his sphere of competence and influence, becomes dependent upon others for the effective and safe outworking of his activities. Dependency is a negation of or a limitation on competence and in the sphere of occupational health and safety the decision making capacity of competent workers may be compromised by overriding decisions of safety-advisors or site managers who may be on the periphery of or outside of particular design and construction activities.

The leadership hierarchies described, whether transactional, LME or transformational in nature are all top-down approaches requiring subordinates to defer to the final decision of the supervisor or manager. There are gradations on the degree of veracity in this assessment, depending upon the industry. Thus for example in high hazard/ low risk industries such as nuclear and nuclear new-build the level of competency required is extremely high and coming with it is the requirement that all members of the construction and industrial teams feed into the defence in depth and safety programmes to a greater extent that would be found in lower hazard industries and construction projects (Petrangelli 2006).

Other factors influence the decision making capacity of individuals and teams, overtly it may be budgetary limitations or resource allocations set by the finance department, competency levels established by Human Resources or general and specific training deficiencies unmet by the training department. Subliminally, workplace culture, and specifically safety will be influenced to a greater or lesser degree by other messages

put out by the company such as drops in profitability, fears of redundancies and so on. These messages work against safety compliance instructions and workers may be held responsible for safety failures in which they participated (McAleenan and McAleenan, 2013).

Leadership requires an all party acceptance of and agreement to the achievement of an objective and a recognition that within the parties all are due equal consideration and respect as human beings (Kohlberg 1971). Without respect, leadership is either a form of managerialism or a transactional relationship based on authority and wages. Eckensberger (2007) in his work on morality and culture postulates all humans as agents capable of self-reflective action. Recognising that heteronomous decision making arises out of necessities, the developing individual moves from heteronomy to autonomy and in the competent person this development has been achieved (within a particular sphere). In this perspective the competent individual or team is not led but supported and appropriately resourced by the structures within the organisation; all be it their activities are towards ends set by others. In safety, by definition it is the competent worker/ team that is the expert and by extension the safety “leader”. Once set to work, the team collectively assess the requirements, including the safety requirements to achieve a successful outcome and collectively set about achieving that outcome. Team leaders may be established but in this context they act as coordinators or facilitators and are not a negation of agency within the team.

DISCUSSION AND CONCLUSION

This critique developed out of research into workplace competence and the fundamental requirements necessary for determining what it is and how it is to be exercised, particularly in the area of workplace health and safety. In addition to the commonplace requirements for knowledge, skills and experience, higher levels of ethics reasoning and agency are deemed central to the decision making processes required of a competent person/ team; the former to determine a correct course of action and the latter to apply that course of action without impediment from unnecessary restrictions or decisions of agents not directly involved in the project. This is particularly true where the safety and welfare of the actors and others are affected by the decisions.

In the outworking the significance of leadership was called into question as it presented a range of contradictions that appeared to negate both the autonomy of the decision maker and the underpinning reasoning that informs decision and action. From an OSH perspective, the appointment of a safety leader or the promotion of safety leadership recognizes the existence of safety failures while at the same time promoting safety as an adjunct to rather than an integral component of competence. Where safety leadership is the provision of good example for others to adopt and implement in an appropriate fashion, there is no contradiction. The “leader” here does not direct the modalities of the work but exercises a function that transfers directly to those who are tasked with conducting work activities and the concomitant reasoning and decision making necessary to make it happen in a safe and healthy manner. However, when it is managerial in form, heteronomy supersedes agency in the work teams and reasoning levels drop to or remain at the conventional mode that requires agents to conform to rules and norms.

The full development of an idea or achievement of progress requires that leadership as a catalyst is relinquished in favour of the collective agency of a mature reasoning

body. From an ethical perspective all human action must of necessity be based on a duty to afford no harm to others; in Kantian terms a particular course of right action is objectively necessary and each individual must exercise autonomy in his decisions. The highest level of ethical reasoning is that in which individuals, teams and organisations have matured from heteronomous to autonomous decision making and are guided by abstract ethical principles and the concept of universal consideration and respect for the dignity of all human beings as individual persons.

Applied to occupational safety and health the rational approach to resolving issue of safety failures is not to develop models of leadership that transfer competence to those who manage but to respect the competence of those who have been specifically engaged and tasked to carry out the work activities. Respect extends to recognising and eliminating impediments to autonomous thinking, decision making and action by competent individuals and teams. Agency therein negates leadership, assuming control of and thereby responsibility and authority for safe outworking of work activities.

REFERENCES

- Chari, V (2012) 21st Century Moral Leadership - Why Resignation has become a strategic option for Corporate Leaders. Accessed online www.academia.edu 17 January 2014.
- Conch, S and Moon S, (2010) Promoting active safety leadership. IOSH, UK 2010
- Eacott, S (2013). Leadership' and the social: time, space and the epistemic, "International Journal of Educational Management", 27(1), 91-101.
- Eacott, Scott, (2014). Beyond the hype of "leadership", Perspectives on Educational Leadership, "Australian Council for Educational Leaders", 20(1), 1-3.
- Eckensberger, L.H., 2007. Morality from a cultural perspective. In Zheng, G Leung K and Adair J
- G (Eds.) "Perspectives and Progress in Contemporary Cross-cultural Psychology", pp. 25-34. Beijing: China Light Industry Press 2007.
- Fresh Minds consultancy (2010) Creating Future Leaders, Institute of Leadership and Management (ILM) UK 2010.
- Fresh Minds (2010) Leading change in the public sector. Institute of Leadership and Management, (ILM) UK 2010.
- Institute of Leadership and Management (ILM) (2010) Politics: Leadership Matters. Institute of Leadership and Management UK 2010.
- Institute of Leadership and Management (ILM) (2011) Index of leadership trust 2011. Institute of Leadership and Management UK 2011.
- Institute of Leadership and Management (ILM) (2012) The leadership and management talent pipeline. Institute of Leadership and Management UK 2012.
- Kant, I (1785). Metaphysics of Morals, cited in Russell, B., (1947). "The History of Western Philosophy", Unwin Brothers Ltd. GB 1947.
- Kohlberg, L (1971) Stages of Moral Development. 1971.
- Kumar, D (2012) Ethical Leadership for the 21st Century. Amity Global Business School, Chandigarh, November, 2012.

- Latour, S M and Rast V J (2004) Dynamic Followership, The Prerequisite for Effective Leadership. "Air and Space Power Journal", 2004, reprinted http://govleaders.org/dynamic_followership.htm 2014.
- Leadersdirect (2014) Thought Leadership. accessed online <http://www.leadersdirect.com/thought-leadership> 17 January 2014.
- Lowder, B T (n.d.) Implementing a Dynamic Leadership Program: A Moral Construct for Adding Cultural Value. Accessed online www.academia.edu 23 April 2014.
- May, T and Pardey, D (2013) Added values, The importance of ethical leadership. Institute of Leadership and Management, (ILM) UK 2013.
- McAleenan, P and McAleenan, C (2009a) An Exploration of Structured and Flexible Approaches to Recognising Engineering Competence. In "Proceedings of CIB W099 Conference", Melbourne 2009.
- McAleenan, P and McAleenan, C (2009b) Development of the Competent Company in the Context of the Seoul Declaration. In "Canadian Society of Safety Engineers PDC proceedings", Canada 2009
- McAleenan, P and McAleenan, C (2010) Calculating your flight distance – the evolution of safety in the competent company. In "Canadian Society of Safety Engineers PDC proceedings", Canada 2010
- McAleenan, P and McAleenan, C (2013) Maturing workplace culture in the context of evolved ethical agency. "Proceedings of CIB World Congress", Brisbane 2013.
- Mostovicz, E I Kakabadse, N K and Kakabadse, A P (2009) A dynamic theory of leadership development,. In "Leadership & Organization Development Journal", Vol. 30 No. 6, 2009 pp. 563-576, Emerald Group Publishing Limited, 2009.
- Petrangelli, G (2006) "Nuclear Safety". Butterworth-Heinemann, Oxford 2006.
- Reid, M (n.d.) A critique of Transformational Leadership theory. Accessed online https://www.academia.edu/300040/A_critique_of_Transformational_Leadership_theory 17 January 2014.
- Spoelstra, S (2013) Is leadership a visible phenomenon? On the (im)possibility of studying leadership. In "Int. J. Management Concepts and Philosophy", Vol. 7, Nos. 3/4, pp.174–188.
- Tummers, L G and Knies, E (2013) Leadership and meaningful work in the public sector. In "Public Administration Review" 73(6), 859–868.

AN EFFECTIVE REMEDY -WORK SAFETY CULTURE

⁹⁵Chit Ko Pe

Workplace Safety and Health Department, Straits Construction Singapore Pte Ltd, Singapore

Repeated practices over time make anyone accustomed. Good or bad, they become norms. Their sustainability over time is seen as good culture while bad one fades off. Generations adhere to good culture and pass it down. In work arena, they are known as safe work practices which breed work safety culture in an organization. A country with such organizations thrives as history and present evidences reveal. Singapore aims at becoming a country renowned for safe and healthy work-environment fostered with work safety culture. The Workplace Safety and Health Council in Singapore develops CultureSAFE programme to encourage all organizations to be well-matured with work safety culture. It is a one-stop platform whereby deep seated safety and health attitudes and perceptions are showcased by the well-established organizations and can be tapped by other organizations in their quest for sustainable ones. It consists of 6 attributes to be tested and built up –leadership & commitment, governance, work management system, competent & learning organization, ownership & teamwork and communication & reporting. A leading local construction company in Singapore is tested on it. Its two workplaces are placed on experiment over 2 years (2012-2013) with a 5-step cyclical approach –diagnostic, reporting, action planning, implementation and review & evaluation. The approach requires perception-based survey, evidence-based assessment, document reviews and interview of persons. With diversity of workforce from different neighbouring countries and time-phase bound sub-contracted nature, the two projects are found standing at different tiers -one project at Participative tier and the other at Proactive tier. CultureSAFE maturity tiers entail Reactive, Participative, Proactive, Progressive and Exemplary in an ascending order. It is evidence that the better result yields at the latter which adopts some behaviour-based safety practices while the former being with few, revealing that work safety culture serves as an effective remedy.

Keywords: Work safety culture, safe work practices, CultureSAFE programme, local, cyclical approach

INTRODUCTION

Safety culture is defined by United Nations Scientific Committee on the Effects of Atomic Radiation as assembly of characteristics and attitudes in organizations and individuals which establishes that, as an overriding priority, [nuclear plant] safety issues receive the attention warranted by their significance.

For the safety culture of an organization, it is defined by Advisory Committee on Safety of Nuclear Installations as the product of individual and group values, attitudes, perceptions, competencies, and patterns of behavior that determine the commitment to, and the style and proficiency of, an organization's health and safety management.

⁹⁵ uchit@straitconstruction.com

In Singapore, CultureSAFE programme in its local version is a platform for organizations to embark on a journey of building workplace safety and health (WSH) culture. It focuses on cultivating the right WSH mindset and attitudes in every employee from top management at office down to the workers on site.

It constitutes a 5-step cyclical approach –diagnostic, reporting, action planning, implementation and review & evaluation.

6. Diagnostic approach entails perception survey and evidence based assessment to establish the present WSH culture profile of the organization.
7. Reporting is all about summarization and presentation of a consolidation of the WSH culture profile of the organization and identification of strengths and areas of improvement.
8. Action planning draws recommendation and prioritization on the action plans or tasks, based on the identified strengths and areas of improvement.
9. Implementation is a means of execution and operation of the accompanied with periodic updates.
10. Review & evaluation focuses on the action plans and track the results of the implementation. It yields either to refine the action plans further to ensure robustness and sustainability and/or to work on other areas of WSH improvements.

The CultureSAFE model which consists of 6 attributes is used to specify 2 key aspects of WSH culture: Organisational Commitment and Stakeholder Commitment. The 6 attributes are WSH leadership and commitment, governance, work management system, competent and learning organization, ownership & teamwork, communicating and reporting.

The CultureSAFE programme is exercised across all projects undertaken by a leading local construction company and its selected 2 construction workplaces are initially kicked off with behavioural observation and intervention approach. It is with a conduct of observation through perception survey among the workforce –managers, supervisors and workers. The sampling choice on the workforce is ensured to reflect the mass standing on their common perception on WSH.

Eventually, it is found that the CultureSAFE programme is an operative approach towards development of the WSH culture at any workplace or organization. Field study over the two years reinforces our belief that work safety culture is an effective remedy to recovery of ill-fated business of an organization due to poor WSH culture.

METHODOLOGY

Behavioural observation and intervention approach

It is a need to prevent any hazardous situations from arising before they lead to accidents or injuries at a workplace. The document reviews at the two workplaces reveal that achievement of WSH management system does not mean safe and healthy workplaces as near-miss incidents, cases requiring first aid, and accidents leading to injuries still occur. They are due to poor implementation of WSH management system, unsafe workplace conditions and/ or at-risk behaviours. They can be further zoomed into one factor - weak WSH culture at the workplaces.

To cure it or recover from such unnecessary hazardous situations, an initiative which is behavioural observation and intervention approach is tested at the workplaces to

help them minimise the occurrence of hazardous situations by focusing on at-risk behaviours.

It intends to make safety a habit for all workers, taking ownership towards the safety of everyone in the workplace.

Steps to implementation

The implementation can be easily broken down into four key steps – SAFE, which is acronym of Scan, Act, Follow up and Evaluate.

Scan

First of all, safety coaches or observers among the workforce are to be identified and assigned. At these two projects, WSH advocates are deployed as safety coaches representing each trade of work and comprising engineers, supervisors and workers. Over time, one year and so later, it progresses to a stage where almost all workers are roped into the approach with peer coaching and each worker starts to develop a sense of ownership of WSH.

A behaviour observation checklist is developed based on behaviour factors, not site conditions. It is a simple one and is placed in use for the first 3 or 4 months. When the workplace is deemed to have fairly cultivated safe work habits at the workplace, other modified checklists are introduced as a replacement of old ones. They vary with specific focus on a wide range of areas such as behaviours relating to safe use of machines/tools, buddy system, and so on. The checklist is prepared with a limit of no more than 10 to 12 items.

Using the checklists, observations are conducted with a proper announcement beforehand for the first 3 or 4 months. With times passed by, unannounced observations are conducted. The observations are in a form of either one-to-one and/or one-to-many/group. The observation durations are kept short - within 10 to 20 minutes.

Act

An incentive or reward is handed out to those workers who demonstrate good behaviour on WSH. It is cash or commodity vouchers given out during daily tool box meetings or weekly safety talk. Furthermore, the recognition never stops there and is reflected on safety notice board updated with their names, photographs and good safety behaviours. It is also an individual performance attribute captured in staff appraisals.

As for those who are with at-risk behaviours, the observer needs to intervene immediately in his/her attempts stop the behaviours or work activities. They need to be counselled if deemed necessary. Peers play a part to show care for one another ensuring everyone remains safe at work.

At the same time, the observer has to step up and explain the WSH concern to the workers. Advice on how the work activity shall be safely carried out is to be offered to them.

Follow up

It is important to adopt no-name-no-blame principle so as to avoid discouraging the workers with at-risk behaviours.

Project management is to be kept in the loop on findings of at-risk behaviours by all means such as direct submission of completed checklists to the management, ad hoc personal discussions with management, or pre-scheduled meeting sessions with the management.

As the management is made known of such cases, its follow-up is necessary to identify the underlying at-risk behaviours in each case. This way leads to developing strategies to tackle with such at-risk behaviours on time.

Evaluate

The observation process is to be repeated with modified checklists. But, it is to be conducted globally rather than targeting any worker or trade-group.

This step needs to determine if the at-risk behaviour persists. Other rounds of observation conducted by different safety coaches or observers can verify if the worker or the group with at-risk behaviour is an isolated one or there is a systemic problem throughout the workplace or the contractor who employs him/her or the group.

Evaluation in this step reveals if the management's follow-up action is effective. If it is found persistent with such at-risk behaviour, the management has to consider to other alternative follow-up actions.

FIELD EXPLORATION

Workplaces chosen

Two ongoing construction workplaces are chosen for the conduct of behavioural observation and intervention approach under CultureSAFE Programme.

Vacanza @ East

It is a proposed condominium housing development comprising 7 blocks of 12-Storey apartments with attic (total 473 Units) at Lengkong Tujoh, Singapore.



Figure 1: Artist's impression on Vacanza@East

Project particulars

- Contract value: US\$ 85.71million
- Contract period: 36 months (Oct/2011 ~ Oct/2013)
- Manpower (Peak): 410
- Machinery -Tower crane: 3
- Sub-contractors: 36

Implementation of behavioural observation and intervention approach

- Time frame: Mar/2012 ~ Oct /2013
- Coverage of trade contractors: Structural, M&E, Architectural
- Coverage of major work activities: Excavation, crane operation, work at heights
- Deployment of safety observer(s): 2 engineers, 6 coordinators/supervisors, 12 workers

Sea Esta

It is a proposed condominium housing development comprising 4 blocks of 13-storey residential units, 2 blocks of 12-storey residential units (total = 376 units) at Pasir Ris Link, Singapore.



Figure 2: Artist's impression on Sea Esta

Project particulars

- Contract value: US\$ 72.86million
- Contract period: 35 months (Jun/2012 ~ May/2015)
- Manpower (Peak): 441
- Machinery -Tower crane: 5
- Sub-contractors: 22

Implementation of behavioural observation and intervention approach

- Time frame: Nov/2012 ~ Dec/2013
- Coverage of trade contractors: Structural, M&E
- Coverage of major work activities: Excavation, crane operation, work at heights
- Deployment of safety observer(s): 2 engineers, 5 coordinators/supervisors, 10 workers

Safety factors

The field exploration is encompassed with several safety factors such as communication, empowerment, feedback, mutual trust, problem identification, promotion of safety, responsiveness, and safety awareness. They are carried out through one-to-one and one-to-group communication, daily tool box meetings, weekly safety talks, weekly work coordination meetings, monthly project WSH committee meetings and ad hoc discussion as well as counselling sessions.

Perception survey

It was conducted in March, 2014 at organization level involving 41 managers, 61 supervisors and 204 workers based on 2:3:10 ratios for the 1500-membered organization.

As there were workers of different nationalities from different countries –China, Bangladesh, India, Myanmar, Thailand and Malaysia, the survey forms were prepared in their own languages to make them understandable on the survey questions.

ANALYSIS AND FINDINGS

Based on the observation survey and site assessment, the analysis is done organization is found at the lower tier of WSH culture rating –reactive. Other ascending tiers are participative, proactive, progressive and exemplary.

Demographic analysis

This analysis is performed individually to determine any difference in responses on the basis of:

- Age
- Nationality
- Job position
- Experience with the organization
- Experience in the construction industry
- Experience in the current position

Table 1 : Number of workers by nationality at Vacanza@East

		No. of workers by nationality						Total
		Chinese	Indian	Bangladeshi	Myanmar	Malay	Thai	
Age (yr)	<20	0	2	0	0	0	0	2
	21-30	36	88	38	8	0	0	170
	31-40	57	46	32	10	7	5	157
	41-50	25	20	21	2	5	1	74
	>51	3	0	0	1	3	0	7
Total		121	156	91	21	15	6	410

Table 2 : Number of workers by nationality at Sea Esta

		No. of workers by nationality						Total
		Chinese	Indian	Bangladeshi	Myanmar	Malay	Thai	
Age (yr)	<20	0	7	0	0	0	0	7
	21-30	55	90	39	7	0	0	191
	31-40	78	55	28	5	18	0	184
	41-50	21	9	12	2	6	1	51
	>51	5	0	0	0	3	0	8
Total		159	161	79	14	27	1	441

Both workplaces are found with young (age: 21-30yrs) workforce being the most manpower while Indian and Chinese workers share the bigger pies of the workforce.

Groups analysis

This analysis is performed group-wise to determine any difference in responses on the basis of:

- Job position within nationality
- Job position within experience level
- Job position within age group
- Nationality within experience level
- Nationality within age group
- Age group within experience level

Table 3 : Number of workers by position & nationality at Vancanza@East

		No. of workers by nationality												Total
		Chinese		Indian		Bangladeshi		Myanmar		Malay		Thai		
		Sup.	Wor.	Sup.	Wor.	Sup.	Wor.	Sup.	Wor.	Sup.	Wor.	Sup.	Wor.	
Age (yr)	<20	0	0	0	2	0	0	0	0	0	0	0	0	2
	21-30	3	33	8	80	2	36	0	8	0	0	0	0	170
	31-40	12	45	5	41	6	26	1	9	0	7	0	5	157
	41-50	5	20	2	18	2	19	2	0	2	3	0	1	74
	>51	1	2	0	0	0	0	1	0	0	3	0	0	7
Total		21	100	15	141	10	81	4	17	2	13	0	6	410
		121		156		91		21		15		6		

Legend: Sup. = Supervisor, Wor. = Worker

Table 4 : Number of workers by position & nationality at Sea Esta

		No. of workers by nationality												Total
		Chinese		Indian		Bangladeshi		Myanmar		Malay		Thai		
		Sup.	Wor.	Sup.	Wor.	Sup.	Wor.	Sup.	Wor.	Sup.	Wor.	Sup.	Wor.	
Age (yr)	<20	0	0	0	7	0	0	0		0	0	0	0	7
	21-30	0	55	18	72	1	38	0	7	0	0	0	0	191
	31-40	12	66	13	42	3	25	3	2	2	16	0	0	184
	41-50	9	12	2	7	2	10	2	0	2	4	0	1	51
	>51	2	3	0	0	0	0	0	0	1	2	0	0	8
Total		23	136	33	128	6	73	5	9	5	22	0	1	441
		159		161		79		14		27		1		

Legend: Sup. = Supervisor, Wor. = Worker

Leadership roles as supervisors are recorded more with age group 31-40yrs while Indian and Chinese workforces share the bigger pie in this regard, too.

Positive safety factor versus accidents & enforcement analysis during the programme period

Table 5 : Number of workers by position & nationality at Sea Esta

A. Safety factor	Vacanza@East	Sea Esta
Survey (one-to-one)	36	155
Survey (one-to-group)	7	22
Daily tool box meetings	78	256
Weekly safety talks	15	62
Weekly work coordination meetings	58	62
Monthly project WSH committee meetings	14	14
Counselling sessions	7	23
Ad hoc discussion	3	12
B. Enforcement:	Vacanza@East	Sea Esta
Minor reportable accident	6	2
Near-miss occurrence	1	0
First aid case	22	8
Warning	88	28
Fine (S\$)	18,100.00	4,800.00

The less the number of positive approach, the worse the situation is in WSH performance. It is shown at those 2 workplaces.

Perception survey analysis

It is analyzed based on 6 attributes –leadership and commitment, governance, work management system, competent & learning organization, ownership & teamwork, and communicating & reporting.



Figure 3: Organization's maturity level by attribute

The organization is found weak in work management system compared to 5 other attributes.

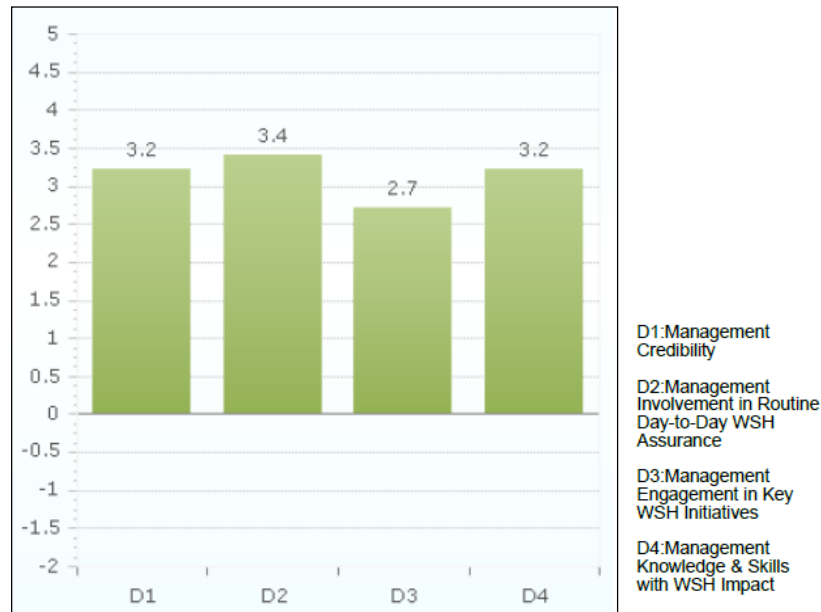

Figure 4: Organization's attribute – leadership & commitment

The organization's WSH leadership & commitment is found relatively strong, but management engagement in key WSH initiatives need to be improved. It is a key attribute which accounts for superior WSH performance. Effective WSH leadership and commitment can shape the WSH values and behaviours of its stakeholders. Organizational commitment to WSH is indicated by the extent to which its management emphasizes WSH commitment as a core and/or personal value.

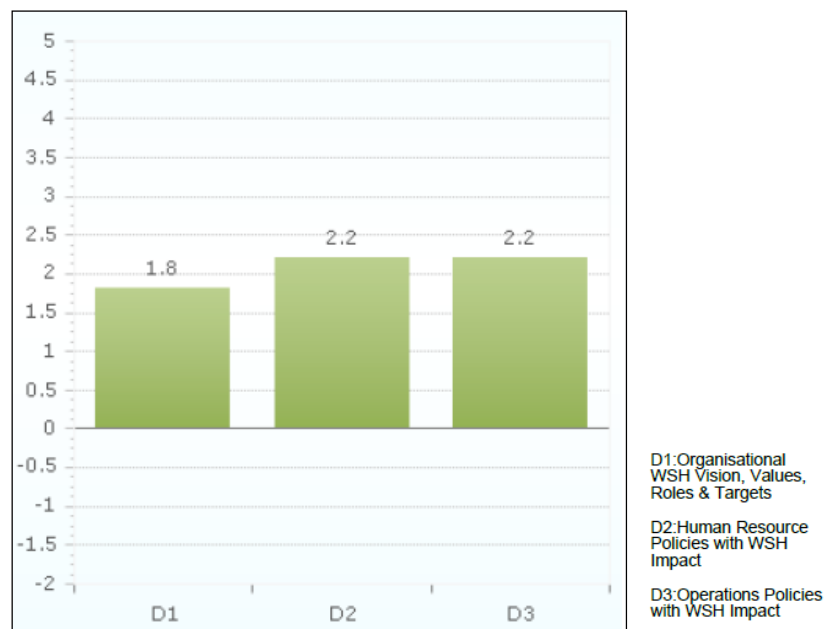

Figure 5: Organization's attribute – governance

The organization's governance on WSH vision, values, roles and target are found average and needed to be updated with the current national or industry trend. 2 other segments in it are also needed to be fine-tuned with the changes in WSH.

Organizational commitment to WSH must be translated into explicit policies and objectives which are applied appropriately to business decisions and operations.

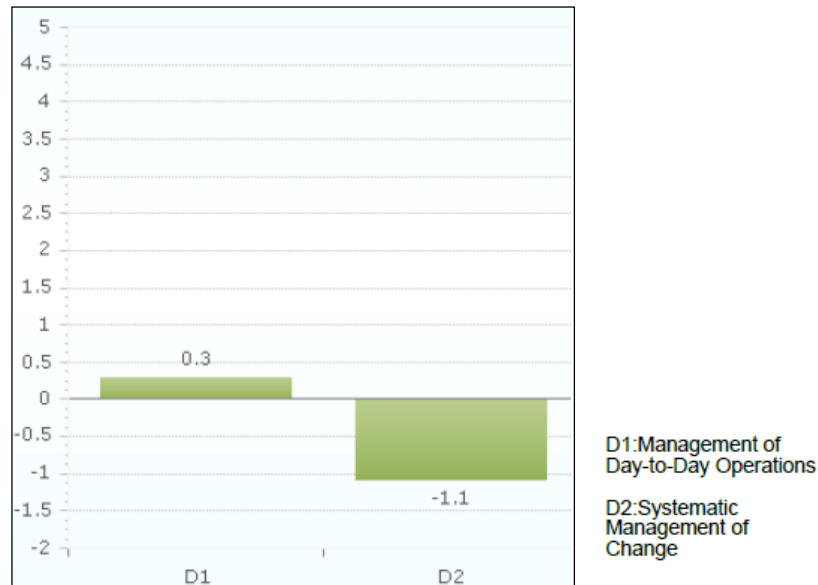

Figure 6: Organization's attribute –work management system

This is the organization's weakness in implementation of safety management system to the fullest vis-à-vis day-to-day work operations. It is likely due to inconsistency in adherence to the organization's QUEST management system by the different project management teams. (QUEST: Quality, Environment, Safety and Training). Effective Work Management Systems should address WSH concerns in day-to-day operations systematically and responsiveness and flexibility may be built in to accommodate change in WSH requirements.

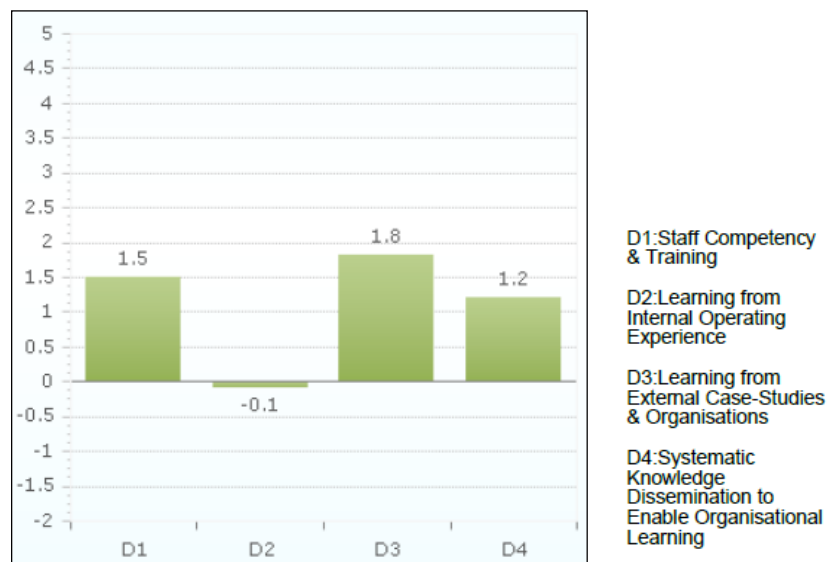

Figure 7: Organization's attribute –competent & learning organization

Learning from internal operating experience is totally found negative and the organization needs to focus on transfer of learning within the workplace or the organization. Competency is emphasized as a key requirement of staff recruitment and promotion and continuous learning is to be emphasized throughout the organization.

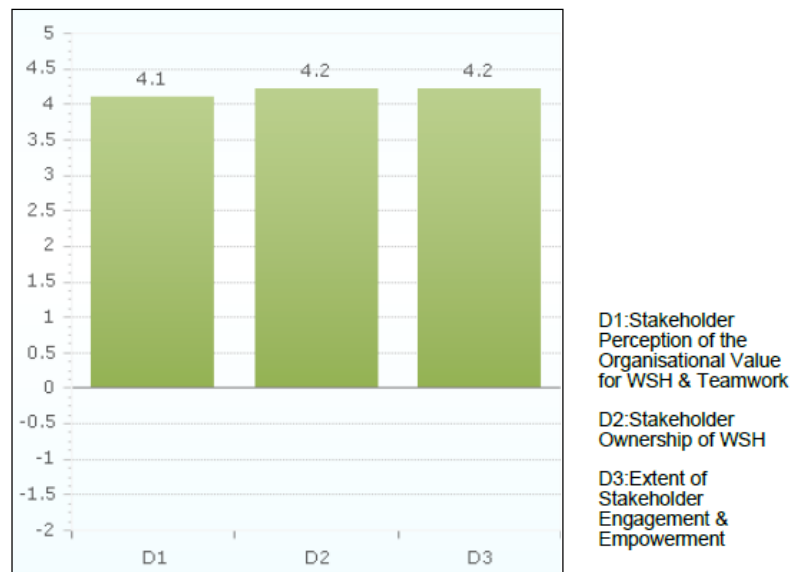

Figure 8: Organization's attribute –ownerships & teamwork

Well, the organization is convincingly found very strong with all stakeholders' ownership on WSH and well rich in teamwork. Ownership of WSH should be by all stakeholders from the CEO down to the last worker. Stakeholders should be engaged in WSH initiatives and understand that each of them play a vital role in WSH. Stakeholders should be motivated and empowered to act on WSH concerns and contribute proactively towards WSH.

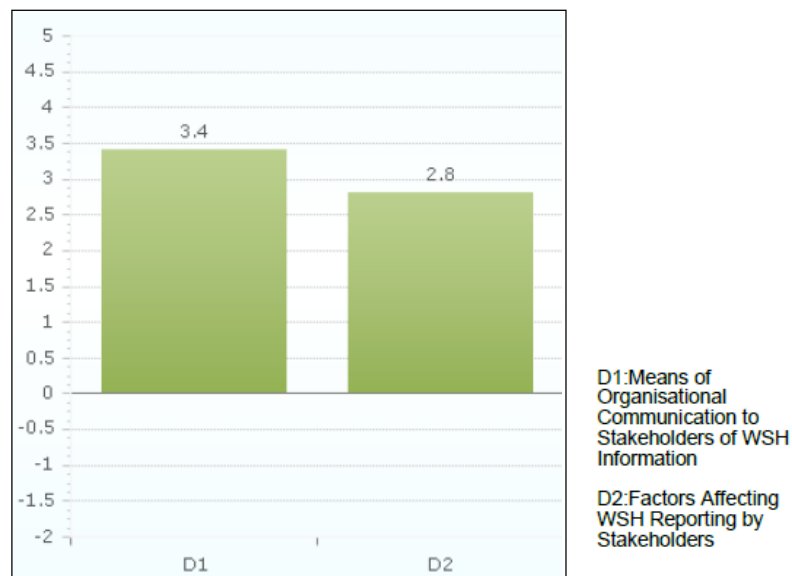

Figure 9: Organization's attribute –communication & reporting

With respect to communication and reporting, the organization stands firm and strong, but there is room to improve with factors affecting WSH reporting by stakeholders such as compliance with the latest legal requirements and client specifications on WSH. Good communication channels must be established to ensure responsive address of WSH concerns and facilitate organizational learning. Stakeholders should be aware of their responsibilities in WSH reporting. WSH reports should be taken seriously. Management should investigate and act on reports timely and visibly.

RECOMMENDATIONS

Based on the analysis and findings at two workplaces and on the organization's WSH culture, the organization needs to step up its efforts to complete the 5-step CultureSAFE cycle as it is at the end of the step 1. Upon completion of the cycle, the organization can be well placed at next level of maturity in WSH culture.

CONCLUSION

This is a remedy to any organization with weak WSH culture and a-step-by-step approach ensures a well nurtured organization with enhanced WSH culture.

The organization may consider to embrace safety as a value and believe in the benefits of any WSH initiatives. Setting up a corporate WSH steering committee will be a driven force to reinforce the initiatives and oversee their implementation in every phase.

Should the organization oversee and enhance its underlying WSH principles in accordance with all attributes of CultureSAFE programme, there will be, in near future, definitely a sustainable work environment wherein a strong work safety culture flourishes.

REFERENCES

Workplace Safety and Health Council, Singapore (2014). *WSH Guide To Behavioural Observation and Intervention*

Workplace Safety and Health Council, Singapore. *CultureSAFE Programme*. Retrieved from <http://www.wshc.sg>

EVALUATING THE INADEQUACIES OF HORIZONTAL LIFELINE DESIGN: CASE STUDIES IN SINGAPORE

Qiao Wang¹, Yee Pin Hoe² and Yang Miang Goh⁹⁶

*¹Safety and Resilience Research Unit (SaRRU), Centre for Project Management and Construction Law,
Department of Building, National University of Singapore*

²Axeltree Consulting and Training Pte Ltd, 100 Tras Street, #16-01 100AM, Singapore 079027

Horizontal lifelines (HLLs) are a commonly used fall arrest system to mitigate the risk of working at height. HLLs need to be designed by professional engineers to ensure that the impact load generated during the fall arrest will not injure the worker or damage the HLL and supporting structure. In addition, the design should verify that there is sufficient height for the worker to fall safely. Standards such as Canadian standard Z259.16 and American standard Z359.6 provide guidelines on the design of fall arrest systems including HLLs. However, these standards are not commonly used internationally. This study aims to evaluate existing designs of HLLs in Singapore based on Z259.16 so as to identify areas of inadequacies. Design calculations of HLLs are collected and evaluated by the authors who were trained in the design of HLL based on Z259.16. In this paper two detailed case studies are presented. Areas of inadequacies include omission of necessary information or consideration, inappropriate design assumptions, and unsuitable calculation method. The inadequacies will be discussed in the context of Singapore's workplace safety and health landscape. The implications of the findings will be also discussed in relation to international work-at-height research. Recommendations will be provided to reduce the current inadequacies.

Keywords: design, engineering, fall arrest, fall from height, fall protection.

INTRODUCTION

Falls are one of the leading causes of fatalities in the construction industry. In Singapore, according to the Workplace Safety and Health Council (WSHC), one out of every three deaths in the workplace was the result of a person falling from height [1], and 17 persons died from falls from roofs, mobile work platforms, scaffolds, ladders and structures in 2011 [2]. Fall arrest systems are widely used to protect the workers in a fall. A vertical lifeline (VLL) is one of the simplest fall arrest system and it consists of a harness worn by the worker attached by a lanyard to a fixed anchor. This fall arrest system is sometimes impractical since it restricts the area that the worker can reach. Horizontal lifeline (HLL) can overcome this restriction and thus it is used more widely in the building industry. A HLL is a component that extends horizontally from one end anchorage to another and consists of a flexible line made from wire, fibre rope, wire rope, or rod, complete with end terminations [3]. However

⁹⁶ bdggym@nus.edu.sg

it is much more complicated than the VLL and the design for HLL becomes more difficult, especially for multiple-span HLLs. In this paper, we will be focusing on the design of HLLs.

As fall arrest systems are the last line of defence for workers falling from height, they must be properly designed to ensure their adequacy. As highlighted by Goh et al. [4], engineers have an important role in designing safe fall arrest systems. An exploratory study by Hoe et al. [5] shows that 79% of the respondents engaged professional Engineers (PEs) to endorse the personal fall arrest systems or components of the system in Singapore construction industry. Goh et al. [6] also have shown that the competency of engineers should be improved in the area of personal fall arrest systems since some designs in Singapore only considered the static load imposed on HLL.

In this paper, we aim to evaluate the inadequacies of horizontal lifeline design in Singapore based on two case studies and use the energy balance method to redesign the cases. Before the case studies are presented, the computational method for fall arrest will be briefly presented and the main formulations of the energy balance method will be given.

COMPUTATIONAL METHODS FOR FALL ARREST

In a fall arrest, exceeding the maximum arrest force and clearance available are potentially dangerous to the user(s). There are two main classes of computational methods to obtain the force in the fall arrest system, one class is analytical methods and the other class is numerical methods.

Analytical methods can be classified into three types, i.e. static analysis, energy analysis and dynamic analysis. The static analysis is not accurate since it does not consider the dynamic force caused by free fall of the worker. The energy analysis uses the concept of conservation of energy [7, 8] to obtain the final peak force and maximum extension of the lifeline. In comparison to static analysis, energy analysis is more aligned with reality and the results are more accurate. However, energy analysis only calculates the force and deflection when the falling worker reaches the lowest point of the first drop. In addition, it can only be used for simple scenarios, such as only one worker falling at one time. In comparison, dynamic analysis [9] can calculate the time history of the falling mass and it can be used to analyse complex fall arrest systems.

Numerical methods [9-11] are mainly based on the dynamic analysis. A specialized time stepping analysis program using methods similar to finite element analysis has been proposed by Drabble [9]. It modelled the wire and lanyard as a series of lumped masses linked by light, non-linear, springs. Krzysztof [12] proposed a method based on non-linear rheological models of visco-elasto-plastic objects for fall arrest system and non-linear differential equation was used in the numerical analysis.

DESIGN OF HORIZONTAL LIFELINES BASED ON ENERGY BALANCE METHOD

In this section, we provide the main formulation of a HLL based on energy balance method described in Figure 1. As illustrated, the span of the HLL is L , the initial mid span sag due to pretension is s_i , the midspan cusp sag is s_c , the maximum anchorage system deflection (MASD) is s . Maximum arrest load (MAL) or the

tension in the cable is T . Maximum arrest force (MAF) or the force in the lanyard is F .

The worker's fall energy U_w is

$$U_w = W(h + s - s_c)$$

where W is the weight of the worker, h is the free fall.

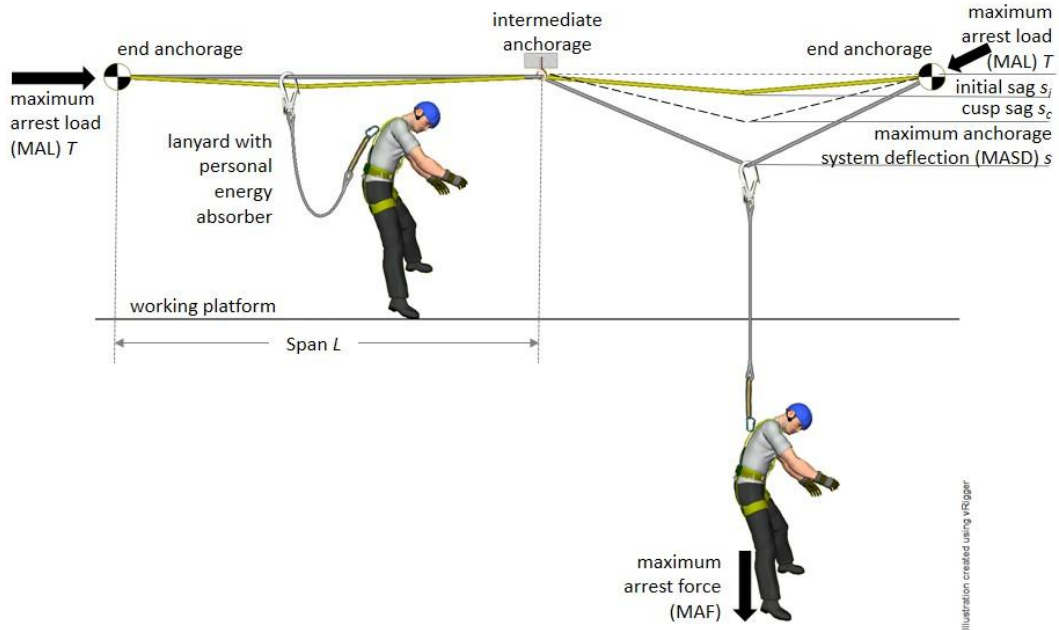

Figure 1. Overview of variables in HLL design

Energy absorbed by the HLL is

$$U_{HLL} = \frac{1}{2} kx^2$$

where U_{HLL} is the energy absorbed by the HLL, k is the rope modulus and $k = AE/l_0$, A is nominal cross section area of the HLL, E is the nominal elastic modulus of the rope, l_0 is the unstressed length of the HLL and x is the elongation of the HLL and

$$x = l - l_i$$

where l is the length of HLL cable under load and l_i is the initial length of the HLL cable.

If we make the energy balance, then

$$W(h + \frac{1}{2}\sqrt{l^2 - L^2} - \frac{1}{2}\sqrt{l_i^2 - L^2}) = \frac{1}{2}k(l - l_i)^2$$

We have to solve the above quartic equation in order to get the unknown l . This equation can be solved but the solution will be very lengthy. A more efficient approach is to increase l until the two sides of the equation are equal. This efficient approach allows an approximate value to be obtained.

Then we can calculate the tension in the cable and the force in the lanyard as

$$T = xk$$

$$F = \frac{4Ts}{L}$$

CASE STUDIES

Two case studies of existing HLL design in Singapore will be presented herein. The existing calculations were compared against those of the authors' (based on the CSA Z259.16 design code). The authors first calculated based on the same parameter values as the existing calculations. Subsequently, the parameter values were adjusted in accordance to the design code and/or values commonly used in Singapore context.

Case study A

This is a temporary, non-manufactured, flexible HLL designed to protect up to 2 users in the event of a fall from the working level to the excavated level 2.7m below.

Despite using the same values for the relevant parameters, the calculation results differed significantly (43% up to 348%) from the authors' results that were calculated based on energy analysis in CSA Z259.16 (see Table 1).

The implications of the authors' results are as follow:

- Cp of 3.155m is more than the available clearance height of 2.7m between the working platform and excavation level. In a fall, the falling user will hit the ground and sustain serious injuries or be killed before his fall is arrested.
- The MAL (tension in HLL) of 99.43kN generated by the falling user(s) has exceeded the 50kN ultimate breaking load of the 10mm 6x7 Fibre Core wire rope and the turnbuckle specified in the design. In the event of user(s) falling, the HLL will break and the fall arrest system will fail catastrophically, resulting in serious injuries or death for the user(s).
- The MAF of 12.18kN far exceeds the 6kN and 8kN safe limit stipulated in CSA Z259.16 Clause 6.4.2.2. The user will sustain serious injuries or be killed by this tremendous MAF to his body.

This HLL is not adequately designed to minimize injuries to the user(s) in a fall or withstand the MAL generated. Different values were then substituted into the calculations and the parameters can be seen in Table 2 while the results are compared in Table 3.

The results shown in Table 3 still differed significantly but this would be more representative of the typical situation in Singapore. There was a drastic improvement in MAF and MAL due to PEAs that are typically used by the users in Singapore. MAF

is now within the recommended safe limits. However, Cp and MAL still exceeds the available clearance and ultimate breaking strength of the wire rope respectively. In fact, the potential deployment of the PEA has added on to the Cp required. In a fall, the user(s) will still hit the ground and the HLL will still break. This design is still not adequate under typical conditions in Singapore construction sites.

It is noted that clause 7.3.3.2 of Z259.16 allows average deployment force of a PEA to be estimated based on 80% of maximum deployment force (6kN in the context of Singapore). However, in this paper the average deployment force is estimated based on 65% of the PEA's maximum arrest force, i.e. 3.9kN. This is based on testing of 31 PEAs conducted by one of the authors. It is noted that the lower average deployment force is more conservative for clearance calculations.

Table 1: Comparison of calculation results using same parameter values - Single Span

	Case Study	Authors'	Difference	Contributing Factors
Maximum HLL sag at fall arrest, S (m)	0.305	0.617	102%	Incorrectly assumed MAL = 22.2kN at end anchorage Did not consider harness and worker stretch-out, Xw
Clearance from platform, Cp (m)	2.205	3.155	43%	Did not account for increased total of free fall and deceleration distance seen by the last user to fall (CSA Z259.16 Clause 8.2.7)
Maximum Arrest Load, MAL (kN)	22.2 (assumed)	99.43	348%	Incorrectly assumed MAL = 22.2kN instead of deriving it
Maximum Arrest Force, MAF (kN)	(Not calculated)	12.18 (each user)	--	Incorrectly assumed MAF of falling user(s) = static load of user(s)

Table 2: Comparison of relevant parameter values

	Case Study	Authors'	Difference	Rationale for using different values
Pre-tension force (kN)	10	2	- 80%	It is unlikely for installers / workers on-site to achieve 10kN pre-tension. 2kN may be more realistic and representative of site conditions.
Lanyard Length (m)	1.0	1.8	80%	Typical lanyards used in Singapore construction sites are fixed 1.8 - 2.0m lengths. It is highly unlikely that users will be specially equipped with 1.0m lanyards just to use this HLL.
Personal Energy Absorber	Nil	Yes	--	Typical lanyards used in Singapore sites are integrated with a PEA and its extension in a fall should be considered in evaluating the clearance height required.
Lumped mass for 2 workers (kg)	200	175	- 12.5%	As per CSA Z259.16 Clause 7.3.7.2, should use lumping factor of 1.75 instead of 2 for two users on flexible anchorage systems

Table 3: Comparison of calculation results using recommended / more representative values - Single Span

	Case Study	Authors'	Difference	Remarks
Maximum HLL sag at fall arrest, S (m)	0.305	0.477	56%	Increased
Clearance from platform, Cp (m)	2.205	4.449	102%	Increased
Maximum Arrest Load, MAL (kN)	22.2 (assumed)	55.33	149%	Improved i.e. decreased
Maximum Arrest Force, MAF (kN)	(Not calculated)	5.25 (each user)	--	Improved - within recommended safe limits

Case study B

This case study is an adapted version of an actual design of a horizontal lifeline by a professional engineer (PE) in Singapore. Figure 2 shows an 8m span horizontal lifeline that uses starter reinforcement bars as anchors. It is designed to protect up to 3 workers.

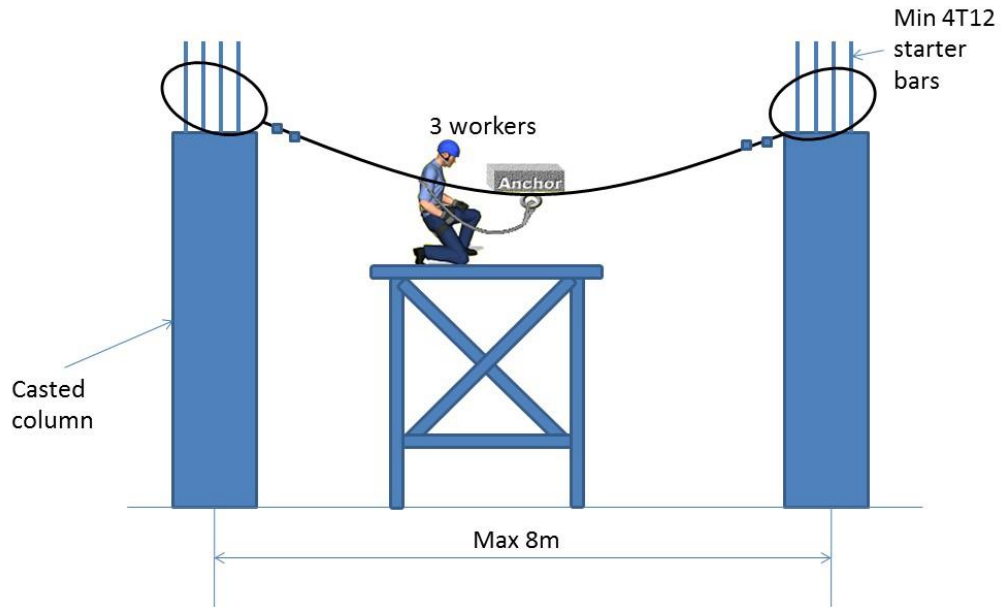

Figure 2. An 8m span horizontal lifeline

In this case study the PE did not indicate many of the parameters necessary for a detailed calculation; even the available height clearance was not indicated. Thus, the authors assumed the following values: diameter of the HLL cable is 9.53mm, nominal elastic modulus of the rope is 55800MPa, unit weight of the cable is 3.2N/m, initial tension of the HLL is 2kN and the free fall is 1.8m.

With reference to Table 4, the PE assumed the maximum HLL sag as 0.5m without any calculations and computed the arrest load by multiplying the static weight of workers by a safety factor. Furthermore, the design has the following inadequacies:

- Failure to consider the dynamic forces during the arrest of the falling user that is significantly higher than the static load. The PE computed the maximum arrest load by multiplying the static load by a safety factor. This simplistic approach is not accurate and will lead to gross underestimation of the arrest load.
- Failure to consider the height clearance required to prevent the user from hitting the ground or other object during the fall arrest. The available height was not even stated.

In contrast to case study A, the PE did not specify the need for personal fall arrest systems for the users of the HLL. Assuming that the same mistake of specifying a personal fall arrest system with no PEA is repeated in this case study, the results obtained by the PE and the authors are shown in Table 4. The following inadequacies can be observed:

- As the PE did not specify the material for the HLL, some commonly used material were used to assess the case study. If the material of the HLL is zinc-coated 7 wire strand, the minimum breaking load for Siemens-martin grade is 30.9kN; for high strength grade it is 48kN and for extra-high strength grade it is 68.4kN. Thus, the maximum arrest load (MAL) (maximum tension in HLL) of 75.94kN generated by the falling user(s) will probably exceed the ultimate breaking load of the wire rope.

- The maximum arrest force (MAF) experienced by the falling worker is 9.62kN, which far exceeds the 6kN and 8kN safe limit stipulated in CSA Z259.16 Clause 6.4.2.2. This outcome is similar to that of case study A.

Table 4: Comparison of calculation results for Case study B - Single Span

	Case Study	Authors'	Difference	Contributing Factors
Maximum HLL sag at fall arrest, S (m)	0.5 (Assumed)	0.775	55.0%	Incorrectly assumed sag S instead of deriving it
Clearance from platform, Cp (m)	(Not calculated)	3.68	--	Did not calculate the clearance
Maximum Arrest Load, MAL (kN)	27.2	75.94	179%	Incorrectly calculated based on wrongly assumed S
Maximum Arrest Force, MAF (kN)	6.75	9.62 (each user)	42.5%	Incorrectly assumed MAF of falling user(s) = static load of user(s) multiply by safety factor

Following case study A, PEAs are introduced. The results in Table 5 assume that PEAs with maximum arrest force of 6kN and average deployment force of 3.9kN were used. With reference to Table 5, the maximum arrest load determined by the PE was 27.2kN. This implies that a material with lower breaking strength can be used. However, from the author's calculations, it can be observed that the maximum arrest load becomes 54.82kN even when PEAs are incorporated into the personal fall arrest systems. This implies that extra-high strength grade material must be used to make sure the HLL do not fail. Alternatively, other design options such as reducing the number of users, incorporating a HLL energy absorber and reducing the span of the HLL will be necessary in ensuring safety of the users.

Table 5: Comparison of calculation results for Case study A - Single Span

	Case Study	Authors'	Comparison
Maximum HLL sag at fall arrest, S (m)	0.5(Assumed)	0.666	33.2%
Clearance from platform, Cp (m)	(Not calculated)	3.80	-
Maximum Arrest Load, MAL (kN)	27.2	54.82	102%
Maximum Arrest Force, MAF (kN)	6.75	6 (per user)	-11.1%

FINDINGS

Both designs had grossly underestimated the strength requirements and neglected critical safety considerations for the users. The inadequacies are highlighted.

Necessary information or considerations omitted

There are two major hazards to the user in a fall arrest system: (i) insufficient clearance height, and (ii) unacceptable maximum arrest force (MAF) to the users.

Clearance required not evaluated adequately

Case study B omitted calculating for clearance while case study A omitted necessary parameters in clearance calculation e.g. harness and worker stretch, additional margin for flexible anchorage systems, increased clearance for equivalent lumped-mass simulation of multiple-worker falls.

Maximum Arrest Force (MAF) not considered

Both designs only considered the strength aspects of the anchorages and components but neglected to evaluate MAF, a critical factor for user's safety.

Inappropriate and inconsistent design assumptions used

Inappropriate design assumptions

One critical incorrect design assumption was not considering the dynamic force component generated in a fall and estimating fall arrest load based on the static weight of the user(s) multiplied by a safety factor. This led to gross underestimation of the actual forces generated to the anchorages, system components and the users.

Both designs also did not consider PEAs that are typically incorporated into lanyards used in construction sites. Case study A also assumed a 1m lanyard instead of the typical 1.8m lanyards in its calculations. While it could be argued that these may be the intention of the designers, the authors are of the view that it would be unwise and impractical to assume that the users would change their typical fall arrest equipment when using the HLL to comply with the design assumptions.

Inconsistent design parameters

Each design assumed different worker mass. This is reflective of the inconsistent design parameters being used in the industry and by different Professional Engineers.

Inappropriate analytical method used

Static analysis used instead of more suitable energy or dynamic analysis

In both designs, static analysis was used. However, CSA Z259.16 Clause 9.3.4.3, among other conditions, does not allow the use of static analysis unless PEAs or clutching SRLs were used to control the MAF. Energy or dynamic analysis is a more suitable analytical method.

Without knowing the MAF value necessary for static analysis, both designs worked around by incorrectly assuming MAF as the static weight of the user(s).

Did not address the intent of the regulations

The Workplace Safety and Health (Work at Heights) Regulations 2013 requires that a fall arrest system

- incorporates a suitable means of absorbing energy and limiting the forces applied to the user's body; and

- in the event of a fall, there is enough fall clearance available to prevent the user from hitting an object, the ground or other surfaces

Both designs did not specify an energy absorbing component or evaluate whether the forces applied to the user's body were acceptable. Case study B did not consider fall clearance at all, while case study A evaluated fall clearance but calculated the fall clearance incorrectly. However, it is noted that both case studies were collected before the regulations came into force.

RECOMMENDATIONS

The following recommendations had been proposed to address the inadequacies highlighted and all of them are in the process of being implemented.

Develop local design code

A local design code can provide the guidance for professional engineers and address the issue of inappropriate calculation method. This was proposed to Singapore's national standards body and a working group had been convened to develop a design code based on CSA Z259.16.

Provide design guidelines as a resource

Common design scenarios can be consolidated as a resource for PEs to reduce the current competency gap and prevent incorrect design parameters. The authors are developing an online knowledge-based system, "Fall Protection System Wizard", which aims to address the problems and inadequacies identified herein.

Educate and out-reach to Professional Engineers

The design code and knowledge-based system serve as resources for PEs, but PEs need to be made aware of the available resources and be educated on how to use them effectively. The Institution of Engineers Singapore (IES) has been conducting one-day workshops to create awareness and a fall protection competent person certification course is being developed.

CONCLUSIONS

The purpose of a fall arrest system such as a Horizontal Lifeline (HLL) is to arrest the fall of a user and minimize injuries to the user. It is also a legal requirement and industry practice in Singapore for fall arrest systems such as HLLs to be properly designed to mitigate the residual risks associated with its usage.

Two designs were evaluated against design code CSA Z259.16 and they were found to be inadequate to achieve the above-mentioned purpose. Instead of using the more appropriate energy analysis, static analysis was incorrectly used. This resulted in strength requirements, clearances and maximum arrest forces to the users being grossly underestimated. Several critical considerations were omitted and design assumptions adopted were inconsistent.

To address these inadequacies, a local design code and a knowledge-based system were being developed to assist professional engineers in Singapore. It is believed that the recommendations will harmonize the calculation methods and design assumptions, thus improving the safety of horizontal lifelines. In addition, training and outreach is necessary to close the competency gap for professional engineers.

ACKNOWLEDGEMENT

The authors gratefully acknowledge the funding and support provided by the Workplace Safety and Health Institute, Singapore and the Ministry of Manpower, Singapore for this study (Project reference - MOMOSDETT12000007).

REFERENCES

- Workplace Safety and Health Council (2008) Technical Advisory for working at Height, WSHC: Singapore.
- Workplace Safety and Health Council (2012) Work place safety and Health Report 2011, WSHC: Singapore.
- Canadian Standards Association Z259.16-04 (2004) Design of Active Fall-Protection Systems, Canadian Standards Association: Ontario.
- Goh, Y M and Hoe, Y P (2011). Engineers' contribution to work-at-height safety: design for safety and design of fall arrest system, in "Conference of the ASEAN Federation of Engineering Organizations (CAFEO)", Bandar Seri Begawan, Brunei.
- Hoe, Y P. and Goh, Y M (2012) Design of Fall Arrest Systems: A Review of the Current Issues in the Singapore Construction Industry, in "CIB W99 International Conference on 'Modelling and Building Health and Safety'", Singapore.
- Goh, Y M and Hoe, Y P (2012) Improving the design of personal fall arrest systems in Singapore. "HEALTH & SAFETY ENGINEERING", 16-19.
- Sulowski, A C (1981) Assessment of maximum arrest force. "National Safety News", 123(4), 50-53.
- Miura, M and Sulowski, A C (1991) Introduction to horizontal lifelines, in Fundamentals of Fall Protection. "International Society for Fall Protection: Canada", 217-283.
- Drabble, F and Brookfield, D (2000) Safety of fall arrest systems: a numerical and experimental study. "Proceedings of the Institution of Mechanical Engineers, Part C: Journal of Mechanical Engineering Science", 214(10), 1221-1233.
- Baszczyński, K and Zrobek, Z (1999) Dynamic performance of horizontal flexible anchor lines during fall arrest--a numerical method of simulation. "International journal of occupational safety and ergonomics: JOSE", 6(4), 521-534.
- Wu, J Z, et al. (2011) Estimation of the kinetic energy dissipation in fall-arrest system and manikin during fall impact. "Ergonomics", 54(4), 367-379.
- Baszczyński, K (2013) Modelling the Performance of Selected Textile Elements of Personal Protective Equipment Protecting Against Falls from a Height During Fall Arrest. "FIBRES & TEXTILES in Eastern Europe", 21(4), 130-136.