



LUND UNIVERSITY

Frequency Dependent Error Bounds for Uncertain Linear Models

Andersson, Lennart; Rantzer, Anders

1998

Document Version:

Publisher's PDF, also known as Version of record

[Link to publication](#)

Citation for published version (APA):

Andersson, L., & Rantzer, A. (1998). *Frequency Dependent Error Bounds for Uncertain Linear Models*. (Technical Reports TFRT-7575). Department of Automatic Control, Lund Institute of Technology (LTH).

Total number of authors:

2

General rights

Unless other specific re-use rights are stated the following general rights apply:

Copyright and moral rights for the publications made accessible in the public portal are retained by the authors and/or other copyright owners and it is a condition of accessing publications that users recognise and abide by the legal requirements associated with these rights.

- Users may download and print one copy of any publication from the public portal for the purpose of private study or research.
- You may not further distribute the material or use it for any profit-making activity or commercial gain
- You may freely distribute the URL identifying the publication in the public portal

Read more about Creative commons licenses: <https://creativecommons.org/licenses/>

Take down policy

If you believe that this document breaches copyright please contact us providing details, and we will remove access to the work immediately and investigate your claim.

LUND UNIVERSITY

PO Box 117
221 00 Lund
+46 46-222 00 00

ISSN 0280-5316
ISRN LUTFD2/TFRT--7575--SE

Frequency Dependent Error Bounds for Uncertain Linear Models

Lennart Andersson
Anders Rantzer

Department of Automatic Control
Lund Institute of Technology
August 1998

Department of Automatic Control Lund Institute of Technology Box 118 S-221 00 Lund Sweden		<i>Document name</i> INTERNAL REPORT	
		<i>Date of issue</i> August 1998	
		<i>Document Number</i> ISRN LUTFD2/TFRT--7575--SE	
<i>Author(s)</i> Lennart Andersson Anders Rantzer		<i>Supervisor</i>	
		<i>Sponsoring organisation</i> Swedish Research Council for Engineering Sciences.	
<i>Title and subtitle</i> Frequency dependent error bounds for uncertain linear models			
<i>Abstract</i> <p>In this report we study frequency dependent error bounds for approximation and truncation of linear dynamic models with uncertainty. The uncertainty is described by quadratic constraints and the error bounds are calculated based on solutions to linear matrix inequalities.</p>			
<i>Key words</i> Model simplification, Model comparison, Uncertain models, Quadratic constraints, Linear matrix inequalities, Error bounds			
<i>Classification system and/or index terms (if any)</i>			
<i>Supplementary bibliographical information</i>			
<i>ISSN and key title</i> 0280-5316			<i>ISBN</i>
<i>Language</i> English	<i>Number of pages</i> 28	<i>Recipient's notes</i>	
<i>Security classification</i>			

The report may be ordered from the Department of Automatic Control or borrowed through:
University Library 2, Box 3, S-221 00 Lund, Sweden
Fax +46 46 222 44 22 E-mail ub2@ub2.lu.se

Contents

1. Introduction	2
2. Preliminaries	2
2.1 Model description	2
2.2 Problem formulation	4
2.3 Quadratic constraints	4
3. Model truncation	6
4. Application example	7
4.1 Nominal model	8
4.2 Uncertain spring constant	9
4.3 Error bounds	9
5. Model comparison and simplification	11
5.1 Model comparison	11
5.2 Model simplification and reduction	12
5.3 Error bounds	14
6. Numerical example	16
7. Some properties of the error bounds	20
7.1 Small error bounds for small errors	20
7.2 An optimality result	21
7.3 Some indications of conservatism	22
8. Numerical computation	23
9. Conclusions	24
Appendix – Proofs of error bound properties	24
Proof of Theorem 3	24
Proof of Theorem 4	25
Proof of Theorem 5	26
References	27

1. Introduction

In modern robust control design it is desirable to model both the dynamics and uncertainty of each component. This often results in aggregated models that have high state order and complicated uncertainty descriptions. These models may be difficult to analyze and the subsequent controller design, based on these models, may be both difficult and time consuming. The resulting controller usually also becomes complex and may therefore be expensive and difficult to implement.

For these reasons there is a need to develop methods to analyze the importance of each uncertainty component as well as each state so that unnecessarily complex models can be avoided. In many situations, such as in controller design, the required accuracy of the model is different at different frequencies. It is therefore desirable to do the analysis frequency by frequency.

For linear time-invariant models without uncertainty there are well-known order reduction methods. Two of these methods are balanced truncation, see [12, 13] and singular perturbation approximation, see [7, 11, 6], which have associated error bounds, see [5, 9, 1, 10]. The balanced truncation method has been generalized to models with norm-bounded uncertainty, see [15, 4, 3] and recently to a more general class of uncertainty descriptions as well as nonlinearities, [14, 2].

In this report we develop, based on the results in [14, 2], frequency dependent error bounds for uncertain linear time-invariant models. The report is organized as follows. We start, in Section 2, by describing the modeling framework and stating the problem. In Section 3 we consider model truncation and present the associated frequency dependent error bounds. An application example is then given in Section 4. Model comparison as well as model reduction using a general reduction method is described in Section 5. A numerical example is given in Section 6. Section 7 discusses some properties of the error bounds. Numerical calculation of the error bounds are described in Section 8 and we conclude the report in Section 9.

2. Preliminaries

In this section we describe the modeling framework and state the problem. The results are developed for the continuous time case even though similar results also hold in discrete time.

2.1 Model description

The modeling framework considered in this report, is commonly used in modern robustness analysis and control design, see *e.g.* the book [16]. The interconnection of a pair (Δ, M) is defined according to the relations

$$x = \Delta z$$

and

$$\begin{bmatrix} z \\ y \end{bmatrix} = M \begin{bmatrix} x \\ u \end{bmatrix},$$

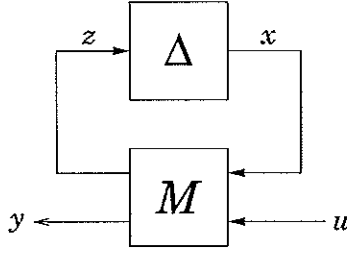

Figure 1 Feedback interconnection representing a model with uncertainty.

as illustrated in Figure 1.

We will usually assume, for stability and well-posedness reasons, that Δ and M are stable proper transfer matrices and that at least one of them is strictly proper. The transfer matrix Δ is used to represent uncertain dynamics as well as known dynamics considered for simplification while M represents the remaining part of the model.

The transfer matrix Δ is also assumed to have a block diagonal structure $\Delta = \text{diag}(\Delta_1, \dots, \Delta_r)$, where each of the blocks satisfy a constraint, e.g. a norm bound or some other quadratic constraint. These quadratic constraints can also be used to describe uncertain dynamics.

The signals in the interconnection are the input $u \in \mathbf{L}_{2e}^m[0, \infty)$, the output $y \in \mathbf{L}_{2e}^p[0, \infty)$ and the internal signals $z \in \mathbf{L}_{2e}^n[0, \infty)$ and $x \in \mathbf{L}_{2e}^n[0, \infty)$. The space $\mathbf{L}_{2e}[0, \infty)$ is the space of functions that are square integrable over any finite time.

The transfer matrix M is partitioned consistently with the signal dimensions as

$$M = \begin{bmatrix} A & B \\ C & D \end{bmatrix}. \quad (1)$$

The input-output mapping of the interconnection in Figure 1 is then defined by the Redheffer star product

$$y = (\Delta \star M)u = (D + C\Delta(I - A\Delta)^{-1}B)u.$$

EXAMPLE 1—UNCERTAIN SPRING CONSTANT

A mass and spring system can be described using the equation

$$m\ddot{\xi} + d\dot{\xi} + k\xi = F$$

where ξ is the position, F an external force, m the mass, d the damping and k the spring constant. Assume that the spring constant is known with only 10% accuracy. This may be written as

$$k = k_0(1 + 0.1\delta)$$

where k_0 is the nominal spring constant and δ a real unknown constant satisfying $|\delta| \leq 1$. The equation then becomes

$$m\ddot{\xi} + d\dot{\xi} + k_0\xi = F - 0.1k_0\delta\xi.$$

The described model, with input F and output ξ , can be written on standard form using

$$M(s) = \frac{1}{ms^2 + ds + k_0} \begin{bmatrix} -0.1k_0 & 1 \\ -0.1k_0 & 1 \end{bmatrix},$$

$$\Delta = \delta.$$

□

2.2 Problem formulation

The problem considered in this report is to analyze the importance of the different blocks in Δ for different frequencies. We would in particular like to compare the original model with one where some of the blocks in Δ have been truncated, simplified or in some other way changed. These results can then be used for model comparison, model simplification and model reduction.

The problem will be solved by finding upper bounds on the error,

$$e = y - \hat{y} = (\Delta \star M - \hat{\Delta} \star M)u,$$

or more precisely the norm

$$\|(\Delta \star M - \hat{\Delta} \star M)(i\omega)\|,$$

between the two compared models. The norm (gain) of a transfer matrix is defined by the maximum singular value as

$$\|G(i\omega)\| = \bar{\sigma}(G(i\omega)).$$

Note that the norm is frequency dependent.

2.3 Quadratic constraints

We use quadratic constraints as a general framework to describe uncertain dynamics as well as known dynamics considered for simplification. This framework includes a number of well-known constraints such as passivity and norm bounds.

We say that the matrix Δ satisfies the quadratic constraint defined by the hermitian matrix Π if

$$\begin{bmatrix} I \\ \Delta \end{bmatrix}^* \Pi \begin{bmatrix} I \\ \Delta \end{bmatrix} \geq 0. \quad (2)$$

The matrix Π will be called a multiplier.

The following two properties are useful.

- Assume that Δ satisfies the quadratic constraints defined by the multipliers Π_1, \dots, Π_n . Then Δ also satisfies the quadratic constraint defined by

$$\Pi = \sum_{k=1}^n \alpha_k \Pi_k$$

for every $\alpha_k \geq 0$, $k = 1, \dots, n$.

- Assume that Δ has a block diagonal structure,

$$\Delta = \text{diag}(\Delta_1, \dots, \Delta_r),$$

and that Δ_k satisfies the quadratic constraints defined by Π_k , for $k = 1, \dots, r$. Then Δ satisfies the quadratic constraint defined by

$$\Pi = \text{daug}(\Pi_1, \dots, \Pi_r),$$

where

$$\text{daug}(\Pi_1, \dots, \Pi_r) = \left[\begin{array}{cc|cc} \Pi_{1(11)} & 0 & \Pi_{1(12)} & 0 \\ & \ddots & & \\ 0 & \Pi_{r(11)} & 0 & \Pi_{r(12)} \\ \hline \Pi_{1(21)} & 0 & \Pi_{1(22)} & 0 \\ & \ddots & & \\ 0 & \Pi_{r(21)} & 0 & \Pi_{r(22)} \end{array} \right],$$

and

$$\Pi_k = \begin{bmatrix} \Pi_{k(11)} & \Pi_{k(12)} \\ \Pi_{k(21)} & \Pi_{k(22)} \end{bmatrix}.$$

Examples of multipliers are given next.

EXAMPLE 2—MULTIPLIERS

- Let $\Delta(i\omega)$ be any unity norm bounded transfer matrix. Then $\Delta(i\omega)$ satisfies all quadratic constraints defined by

$$\begin{bmatrix} x(\omega)I & 0 \\ 0 & -x(\omega)I \end{bmatrix}$$

where $x(\omega) \geq 0$.

- Let $\Delta(i\omega) = \delta I$, where δ is a real scalar satisfying $|\delta| \leq 1$, then $\Delta(i\omega)$ satisfies all quadratic constraints defined by

$$\begin{bmatrix} X(i\omega) & Y(i\omega) \\ Y(i\omega)^* & -X(i\omega) \end{bmatrix}$$

where $X(i\omega) = X(i\omega)^* \geq 0$ and $Y(i\omega) + Y(i\omega)^* = 0$. □

It will be shown later that the multipliers $\Pi(i\omega)$ play a fundamental role when we compute bounds on the error between two models.

The same Δ satisfies the quadratic constraints defined by many different multipliers Π . The particular choice of multiplier will influence the error bounds. In order to obtain less conservative error bounds it is therefore important to choose the multiplier Π resulting in the lowest error bound. Restricting the set of multipliers beforehand may therefore result in more conservative error bounds than necessary.

EXAMPLE 3—QUADRATIC CONSTRAINTS FOR AN INTEGRATOR

Assume that $\Delta(s) = 1/s$. Then $\Delta(i\omega)$ satisfies the quadratic constraint defined by

$$\Pi(i\omega) = \begin{bmatrix} 0 & x(\omega) \\ x(\omega) & 0 \end{bmatrix},$$

where $x(\omega) \geq 0$ is a real-valued function. Multipliers of this form define quadratic constraints that are satisfied for any positive real transfer function. Thus, restricting the multiplier to have this form, may lead to conservative error bounds, since the error bounds will hold not only if Δ is an integrator but also if Δ is any positive real transfer function. \square

3. Model truncation

In this section we present frequency dependent upper bounds on the error when parts of the model is truncated. This is a special case of the more general results presented in Section 5.

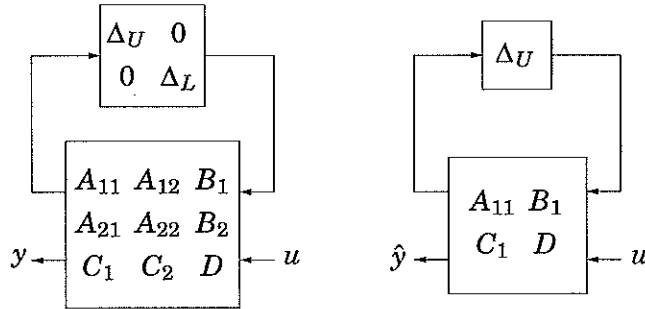

Figure 2 Model truncation.

Model truncation is illustrated in Figure 2. We assume, without loss of generality, that the model is partitioned in such a way that the lower blocks of Δ and the corresponding part of M should be truncated. We partition the model consistently as

$$M = \begin{bmatrix} A_{11} & A_{12} & B_1 \\ A_{21} & A_{22} & B_2 \\ C_1 & C_2 & D \end{bmatrix}, \quad \Delta = \begin{bmatrix} \Delta_U & 0 \\ 0 & \Delta_L \end{bmatrix},$$

where

$$\begin{aligned} \Delta_U &= \text{diag}(\Delta_1, \dots, \Delta_{\hat{r}}), \\ \Delta_L &= \text{diag}(\Delta_{\hat{r}+1}, \dots, \Delta_r). \end{aligned}$$

The truncated model is then given by

$$\hat{M} = \begin{bmatrix} A_{11} & B_1 \\ C_1 & D \end{bmatrix}, \quad \hat{\Delta} = \Delta_U.$$

We assumed above that the parts to be truncated were specified beforehand. This is not always the case. Instead we can make this specification based on positive real-valued functions $\sigma_k(\omega)$ that we assign to each of the blocks in Δ , as illustrated in Figure 8. Each function $\sigma_k(\omega)$ gives a measure on the importance of the corresponding block Δ_k at each frequency. When the model is truncated then the error at each frequency, is bounded by two times the sum of the σ_k -functions corresponding to the truncated blocks. This is stated in the following theorem, which follows from the more general result presented later in Theorem 2.

THEOREM 1

Assume that Δ and M are stable proper transfer matrices and at least one of them is strictly proper. Let $\Pi_k(i\omega)$, for $k = 1, \dots, r$, be bounded measurable functions taking hermitian values. Assume for all $\omega \in \mathbf{R}$ that

- $\tau \Delta_k(i\omega)$, for $k = 1, \dots, r$, and all $\tau \in [0, 1]$ satisfies the quadratic constraint defined by $\Pi_k(i\omega)$
- $\Pi_{k(11)}(i\omega) \geq 0$, for $k = \hat{r} + 1, \dots, r$

If there exist real valued functions $\sigma_1(\omega), \dots, \sigma_r(\omega) > 0$ such that

$$\begin{bmatrix} A(i\omega) & B(i\omega) \\ I & 0 \end{bmatrix}^* \text{daug}(\Pi_1(i\omega), \dots, \Pi_r(i\omega)) \begin{bmatrix} A(i\omega) & B(i\omega) \\ I & 0 \end{bmatrix} < \begin{bmatrix} 0 & 0 \\ 0 & I \end{bmatrix},$$

$$\begin{bmatrix} A(i\omega) \\ I \end{bmatrix}^* \text{daug}(\sigma_1^2 \Pi_1(i\omega), \dots, \sigma_r^2 \Pi_r(i\omega)) \begin{bmatrix} A(i\omega) \\ I \end{bmatrix} + C(i\omega)^* C(i\omega) < 0,$$

for all $\omega \in [0, \infty]$, then both the original and truncated model are stable and

$$\|(\Delta \star M - \hat{\Delta} \star \hat{M})(i\omega)\| \leq 2\sigma_{\hat{r}+1}(\omega) + \dots + 2\sigma_r(\omega).$$

□

The frequency dependent error bounds are given in terms of nonunique σ_k -functions, which are found by solving the two inequalities numerically, see Section 8. No restrictions on the type of realization (such as in balanced truncation) are needed.

The theorem is applicable to uncertain models since it is sufficient that Δ and $\hat{\Delta}$ belong to the set described by the quadratic constraints. It is, thus, not necessary to know the specific transfer matrix Δ .

An example is given in the next section to illustrate the use of the theorem.

4. Application example

In this section we consider simplification of an uncertain model of the flexible servo in Figure 3. First we give a nominal model, then we extend this model to include an uncertain spring constant. The importance of the uncertainty description is analyzed.

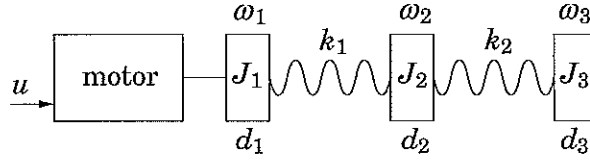

Figure 3 A flexible servo.

4.1 Nominal model

A simple model of the servo in Figure 3 is given by the following equations

$$\begin{aligned}
 J_1 \dot{\omega}_1 &= -k_1(\phi_1 - \phi_2) - d_1 \omega_1 + k_u u \\
 J_2 \dot{\omega}_2 &= k_1(\phi_1 - \phi_2) - k_2(\phi_2 - \phi_3) - d_2 \omega_2 \\
 J_3 \dot{\omega}_3 &= k_2(\phi_2 - \phi_3) - d_3 \omega_3 \\
 \dot{\phi}_1 &= \omega_1 \\
 \dot{\phi}_2 &= \omega_2 \\
 \dot{\phi}_3 &= \omega_3 \\
 y &= k_\omega \omega_1
 \end{aligned}$$

where ω_k denotes angular velocity and ϕ_k the corresponding angle. The system output is the voltage y representing the angular velocity of the first mass. We assume that the parameters are

$$\begin{aligned}
 J_1 &= 50 \cdot 10^{-6} \text{ kgm}^2 \\
 J_2 &= 20 \cdot 10^{-6} \text{ kgm}^2 \\
 J_3 &= 55 \cdot 10^{-6} \text{ kgm}^2 \\
 d_1 = d_2 = d_3 &= 30 \cdot 10^{-6} \text{ Nm/rad/s} \\
 k_1 = k_2 &= 400 \cdot 10^{-6} \text{ Nm/rad} \\
 k_u &= 25 \cdot 10^{-3} \text{ Nm/V} \\
 k_\omega &= 0.1 \text{ V/rad/s.}
 \end{aligned}$$

Introducing the state vector

$$v^T = [\omega_1 \quad \omega_2 \quad \omega_3 \quad \phi_1 - \phi_2 \quad \phi_2 - \phi_3]$$

results in the state space model,

$$\dot{v} = \begin{bmatrix} -d_1/J_1 & 0 & 0 & -k_1/J_1 & 0 \\ 0 & -d_2/J_2 & 0 & k_1/J_2 & -k_2/J_2 \\ 0 & 0 & -d_3/J_3 & 0 & k_2/J_3 \\ 1 & -1 & 0 & 0 & 0 \\ 0 & 1 & -1 & 0 & 0 \end{bmatrix} v + \begin{bmatrix} k_u/J_1 \\ 0 \\ 0 \\ 0 \\ 0 \end{bmatrix} u$$

$$y = [k_\omega \quad 0 \quad 0 \quad 0 \quad 0] v.$$

This model may be written in a more compact way as

$$\begin{aligned}
 \dot{v} &= \bar{A}v + \bar{B}u \\
 y &= \bar{C}v.
 \end{aligned}$$

The Bode diagram for the model is given in Figure 4. We see that there are resonances at 9 rad/s and 22 rad/s and notches at 6 rad/s and 21 rad/s.

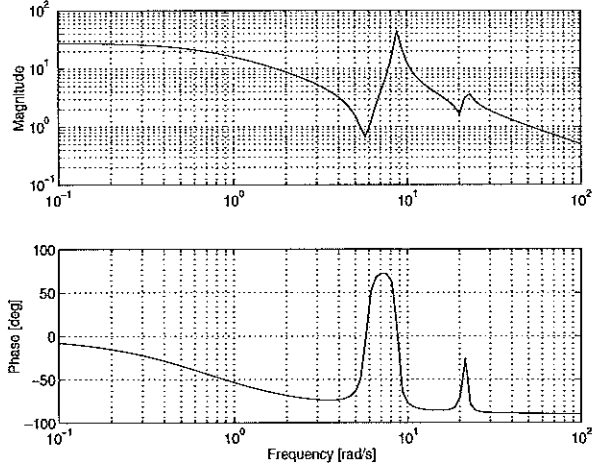

Figure 4 Bode diagram for the flexible servo. There is one resonance at 9 rad/s and one at 22 rad/s.

4.2 Uncertain spring constant

We assume that the spring constant k_1 is known with only 10% accuracy. This uncertain spring constant \bar{k}_1 is modeled as

$$\bar{k}_1 = k_1(1 + 0.1\delta_k)$$

where $|\delta_k| \leq 1$ and k_1 is the nominal spring constant. Using this description we find that

$$\dot{v} = \bar{A}v + \bar{A}[0 \ 0 \ 0 \ 1 \ 0]^T \delta_k \cdot 0.1 \cdot [0 \ 0 \ 0 \ 1 \ 0]v + \bar{B}u$$

and get the model (Δ, M) where $\Delta = \delta_k$ and

$$M = \begin{bmatrix} A & B \\ C & D \end{bmatrix}$$

with

$$\begin{aligned} A &= 0.1 \cdot [0 \ 0 \ 0 \ 1 \ 0](sI - \bar{A})^{-1}\bar{A}[0 \ 0 \ 0 \ 1 \ 0]^T \\ B &= 0.1 \cdot [0 \ 0 \ 0 \ 1 \ 0](sI - \bar{A})^{-1}\bar{B} \\ C &= \bar{C}(sI - \bar{A})^{-1}\bar{A}[0 \ 0 \ 0 \ 1 \ 0]^T \\ D &= \bar{C}(sI - \bar{A})^{-1}\bar{B}. \end{aligned}$$

4.3 Error bounds

We are interested in analyzing in what frequency ranges the nominal model is a sufficient description of the uncertain model. We will therefore calculate error bounds that measure the difference between the nominal model and the uncertain model.

The uncertainty is represented by a unity norm bounded real scalar δ_k . Such a scalar satisfies any quadratic constraint defined by

$$\Pi(i\omega) = \begin{bmatrix} x(\omega) & y(i\omega) \\ y(i\omega)^* & -x(\omega) \end{bmatrix}$$

where $x(\omega) \geq 0$ is real and $\text{Re } y(i\omega) = 0$. Applying Theorem 1 using this multiplier and numerical optimization, see Section 8, we find the upper bound $2\sigma(\omega)$, shown in Figure 5 with a solid line. The best possible upper bound (the exact error can not be determined since the original model is uncertain) is shown with a dashed line. We see that the obtained upper

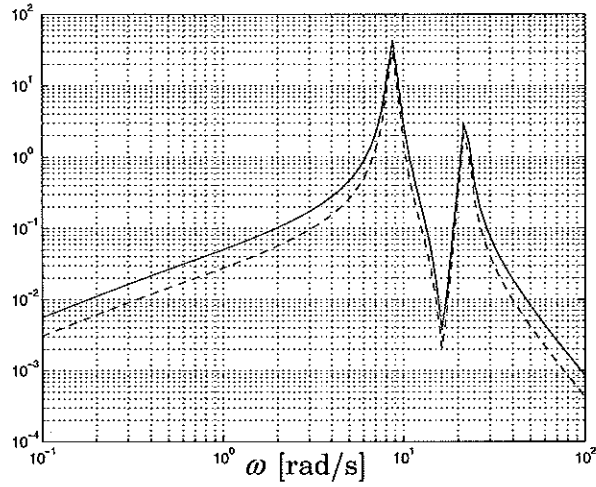

Figure 5 This figure shows upper bounds on the error when the uncertainty in the spring constant k_1 is neglected. The solid line shows the error bound obtained using our method while the dashed line shows the best possible upper bound.

bound is close to the best possible upper bound. Analytical expressions for both upper bounds in this example will be obtained analytically in Theorem 4.

The upper bounds show that the error is large close to the resonance and notch frequencies. This is intuitively reasonable since the resonances and notches move when the spring constant is changed, resulting in large differences in amplification near the resonance and notch frequencies.

The obtained information can be used to help us to decide if the uncertainty should be considered in the design of a controller. Let G denote the nominal transfer function of the system and let G_c denote the transfer function of the controller. Assume that the closed loop model is stable. Let $G + \Delta G$ denote the transfer function of the true system, then stability is preserved for the true closed loop system if

$$|G_c(i\omega)G(i\omega) + 1| > |\Delta G(i\omega) \cdot G_c(i\omega)|$$

or equivalently if

$$\left| \frac{\Delta G(i\omega)}{G(i\omega)} \right| \left| \frac{G(i\omega)G_c(i\omega)}{1 + G(i\omega)G_c(i\omega)} \right| < 1.$$

This means that stability is preserved if the gain of the nominal closed loop model is small at frequencies where the relative error of the model is large and vice versa. Based on the relative error bound shown in Figure 6, we conclude that stability is preserved if the closed loop model has a bandwidth less than about 5 rad/s. This means that the uncertainty in the spring constant k_1 , from a stability point of view, may be neglected, in this case, when we make the design.

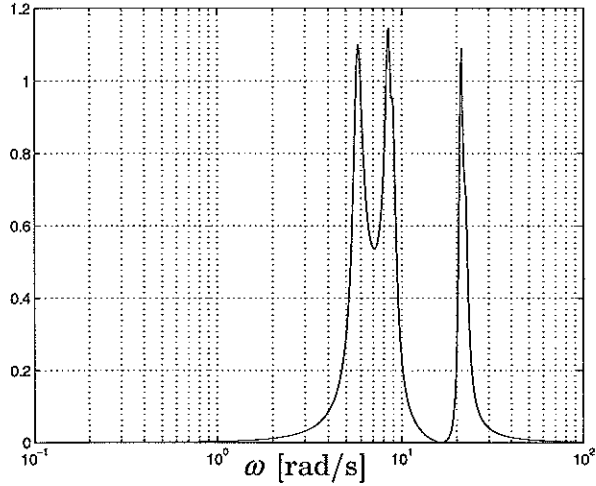

Figure 6 Upper bound on the relative error when the uncertainty in the spring constant k_1 is neglected. It is seen that the uncertainty description is important close to resonances and notches.

Note that we have only considered stability. Similar arguments can be used if we in addition would like to preserve some performance specifications.

5. Model comparison and simplification

In this section we describe model comparison and how it can be used for model simplification and model reduction. A special case of these results are truncation, which we described in Section 3.

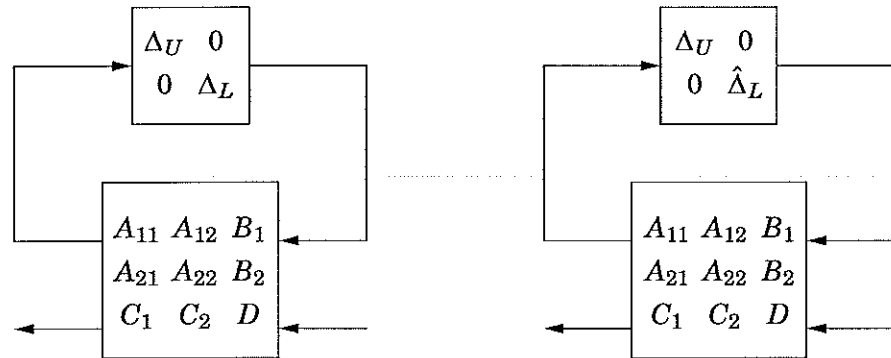

Figure 7 The two models that we compare.

5.1 Model comparison

Consider comparison of two models that are identical except for some of the blocks in Δ , see Figure 7. We assume, without loss of generality, that the upper blocks in Δ , denoted $\Delta_U = \text{diag}(\Delta_1, \dots, \Delta_{\hat{r}})$, are identical while the lower blocks denoted $\Delta_L = \text{diag}(\Delta_{\hat{r}+1}, \dots, \Delta_r)$ and $\hat{\Delta}_L = \text{diag}(\hat{\Delta}_{\hat{r}+1}, \dots, \hat{\Delta}_r)$,

respectively, not are identical. We partition the two models consistently as

$$M = \begin{bmatrix} A_{11} & A_{12} & B_1 \\ A_{21} & A_{22} & B_2 \\ C_1 & C_2 & D \end{bmatrix}, \quad \Delta = \begin{bmatrix} \Delta_U & 0 \\ 0 & \Delta_L \end{bmatrix}, \quad \hat{\Delta} = \begin{bmatrix} \Delta_U & 0 \\ 0 & \hat{\Delta}_L \end{bmatrix}.$$

To compare the two models we assign positive real-valued functions $\sigma_k(\omega)$ to each of the blocks in Δ , as illustrated in Figure 8. Each function $\sigma_k(\omega)$ gives a measure on the importance of the corresponding block Δ_k .

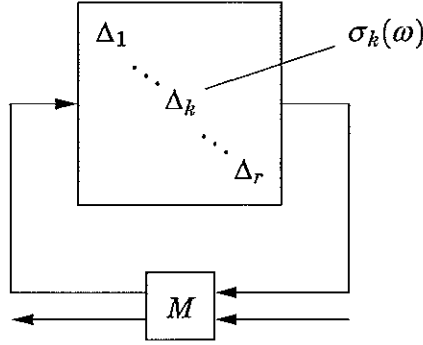

Figure 8 Each block Δ_k has an associated function $\sigma_k(\omega)$ that measure the importance of the block at each frequency.

The error between the two models, is bounded by two times the sum of the σ_k -functions corresponding to the nonidentical blocks. Note, that the σ_k -functions will depend on the selection of a set containing both Δ_k and $\hat{\Delta}_k$, see Figure 9.



Figure 9 Both the block Δ_k and $\hat{\Delta}_k$ must belong to the same set described by a quadratic constraint.

5.2 Model simplification and reduction

The described comparison of models may be used for model simplification. The second model is in this case considered as a simplification of the first model. To choose which of the blocks in Δ to simplify, we may look at the σ_k -functions since they indicate for which of the blocks in Δ simplification is cheapest. The simplification is then done by replacing Δ_L with a fixed transfer matrix $\hat{\Delta}_L$, with the same block structure as Δ_L . We choose the replacing transfer matrix to be frequency independent to avoid unnecessary dynamics, and choose it close to Δ_L to obtain a simplified model close to the original model. The last statement is motivated by the following result, which shows that the error between the two models is small if Δ and $\hat{\Delta}$ are close to each other.

Assume that (Δ, M) is stable. Then for every $\varepsilon > 0$ there exist a $\delta > 0$ such that

$$\|\Delta \star M - \hat{\Delta} \star M\| < \varepsilon \quad \text{when} \quad \|\Delta - \hat{\Delta}\| < \delta.$$

This follows since

$$\Delta \star M - \hat{\Delta} \star M = C\Delta(I - A\Delta)^{-1}B - C\hat{\Delta}(I - A\hat{\Delta})^{-1}B$$

is a continuous function of the matrix elements, and no singularities occur thanks to the stability assumption.

After the described simplification, an upper bound on the error is found by summing the σ_k -functions corresponding to the blocks that have been replaced.

The spatial dimension of the simplified model may be reduced. This follows by observing that

$$\begin{bmatrix} \Delta_U & 0 \\ 0 & \hat{\Delta}_L \end{bmatrix} \star M = \Delta_U \star \hat{M}, \quad (3)$$

where

$$\hat{M} = \begin{pmatrix} A_{11} & B_1 \\ C_1 & D \end{pmatrix} + \begin{pmatrix} A_{12} \\ C_2 \end{pmatrix} \hat{\Delta}_L (I - A_{22}\hat{\Delta}_L)^{-1} \begin{pmatrix} A_{21} & B_2 \end{pmatrix}.$$

This is illustrated in Figure 10. Note that it is crucial for this reduction that $\hat{\Delta}_L$ is a fixed transfer matrix, and not a set of transfer matrices, so that \hat{M} becomes a fixed transfer matrix. In some cases it is in addition useful to have M frequency independent. To maintain this property after the reduction, we use a frequency independent $\hat{\Delta}_L$.

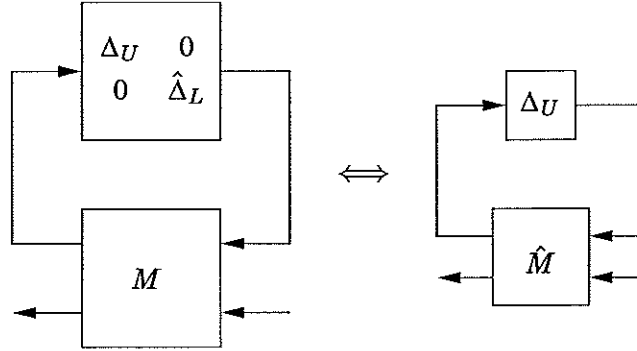

Figure 10 Model reduction. A fixed transfer matrix $\hat{\Delta}_L$ may be captured in M . The new model (Δ_U, \hat{M}) will then have a lower, *i.e.* reduced, spatial dimension.

EXAMPLE 4—TRUNCATION

Choosing the fixed matrix $\hat{\Delta}_L = 0$ results in a reduced model with

$$\hat{M} = \begin{bmatrix} A_{11} & B_1 \\ C_1 & D \end{bmatrix}.$$

This model is simply a truncation of the original model. This was the special case considered in Section 3. \square

5.3 Error bounds

We now present the frequency dependent error bounds associated with model comparison and simplification.

THEOREM 2

Assume that M is a stable proper (strictly proper) transfer matrix and that we have two stable strictly proper (proper) block diagonal transfer function matrices

$$\begin{aligned}\Delta &= \text{diag}(\Delta_1, \dots, \Delta_r), \\ \hat{\Delta} &= \text{diag}(\Delta_1, \dots, \Delta_{\hat{r}}, \hat{\Delta}_{\hat{r}+1}, \dots, \hat{\Delta}_r).\end{aligned}$$

Let $\Pi_k(i\omega)$, for $k = 1, \dots, r$, be bounded measurable functions taking hermitian values. Assume for all $\omega \in \mathbf{R}$ and all $\tau \in [0, 1]$ that

- $\tau \Delta_k(i\omega)$, for $k = 1, \dots, r$, satisfies the quadratic constraint defined by $\Pi_k(i\omega)$
- $\tau \hat{\Delta}_k(i\omega)$, for $k = \hat{r} + 1, \dots, r$, satisfies the quadratic constraint defined by $\Pi_k(i\omega)$

If there exist real-valued functions $\sigma_1(\omega), \dots, \sigma_r(\omega) > 0$ such that

$$\begin{bmatrix} A(i\omega) & B(i\omega) \\ I & 0 \end{bmatrix}^* \text{daug}(\Pi_1(i\omega), \dots, \Pi_r(i\omega)) \begin{bmatrix} A(i\omega) & B(i\omega) \\ I & 0 \end{bmatrix} < \begin{bmatrix} 0 & 0 \\ 0 & I \end{bmatrix} \quad (4)$$

$$\begin{bmatrix} A(i\omega) \\ I \end{bmatrix}^* \text{daug}(\sigma_1^2 \Pi_1(i\omega), \dots, \sigma_r^2 \Pi_r(i\omega)) \begin{bmatrix} A(i\omega) \\ I \end{bmatrix} + C(i\omega)^* C(i\omega) < 0 \quad (5)$$

for all $\omega \in [0, \infty]$. Then both (Δ, M) and $(\hat{\Delta}, \hat{M})$ are stable and

$$\|(\Delta \star M - \hat{\Delta} \star M)(i\omega)\| \leq 2\sigma_{\hat{r}+1}(\omega) + \dots + 2\sigma_r(\omega).$$

Let (Δ_U, \hat{M}) be the reduced order model obtained using the reduction formula (3) then

$$\|(\Delta \star M - \Delta_U \star \hat{M})(i\omega)\| \leq 2\sigma_{\hat{r}+1}(\omega) + \dots + 2\sigma_r(\omega).$$

Remark 1 Model truncation corresponds to $\hat{\Delta}_k = 0$. The only constraint on the multiplier Π_k in this case is $\Pi_{k(11)} \geq 0$. This condition is found in Theorem 1.

Remark 2 How to compute σ_k -functions satisfying these inequalities is described in Section 8. Note that the σ_k -functions are not unique.

Remark 3 We describe Δ using quadratic constraints. It is therefore not necessary to know the specific transfer matrix Δ . This makes the result applicable to models where Δ is uncertain. One must then find a quadratic constraint that is satisfied for all Δ in the uncertainty set.

Remark 4 The assumptions on $\Delta, \hat{\Delta}$ and M to be stable and proper may be replaced with the assumption that both the original and truncated models are stable. Then it is also sufficient that $\Delta_k, \hat{\Delta}_k$ satisfy the quadratic constraint for $\tau = 1$ and not for all $\tau \in [0, 1]$. The strict inequalities may in addition be replaced by non-strict inequalities. This version of the assumptions is useful when *e.g.* Δ is unstable, for example when Δ contains integrators.

Proof We start by proving stability. This proof is only given for the model (Δ, M) since the proof for $(\hat{\Delta}, M)$ is identical.

We will consider the model where Δ is replaced with $\tau\Delta$ and show that this model is stable for $\tau = 1$. Stability means that all the poles are in the open left half plane. This holds for $\tau = 0$ since both Δ and M are stable. If no pole crosses the imaginary axis as we let τ increase from zero to one, then the model (Δ, M) will be stable. It therefore remains to check that there are no imaginary poles for any value on $\tau \in [0, 1]$, *i.e.*

$$\det(I - A(i\omega)\tau\Delta(i\omega)) \neq 0, \quad \omega \in [0, \infty], \quad \tau \in [0, 1].$$

This holds if

$$\begin{bmatrix} I & A(i\omega) \\ \tau\Delta(i\omega) & I \end{bmatrix}$$

is invertible, *i.e.* the columns are linearly independent. If we assume that they are linearly dependent then

$$\begin{bmatrix} A \\ I \end{bmatrix} w_1 = \begin{bmatrix} I \\ \tau\Delta \end{bmatrix} w_2, \quad w_1 \neq 0, w_2 \neq 0.$$

This implies that

$$w_1^* \begin{bmatrix} A \\ I \end{bmatrix}^* \Pi \begin{bmatrix} A \\ I \end{bmatrix} w_1 = w_2^* \begin{bmatrix} I \\ \tau\Delta \end{bmatrix}^* \Pi \begin{bmatrix} I \\ \tau\Delta \end{bmatrix} w_2$$

which is a contradiction since

$$\begin{bmatrix} A \\ I \end{bmatrix}^* \Pi \begin{bmatrix} A \\ I \end{bmatrix} < 0$$

and

$$\begin{bmatrix} I \\ \tau\Delta \end{bmatrix}^* \Pi \begin{bmatrix} I \\ \tau\Delta \end{bmatrix} \geq 0.$$

This proves stability.

We now prove the error bounds for the case with $\hat{r} = 1$ and $r = 2$. The case with $\hat{r} = r = 1$ is almost identical, but less pedagogical. We partition the matrix M as

$$M = \begin{bmatrix} A_{11} & A_{12} & B_1 \\ A_{21} & A_{22} & B_2 \\ C_1 & C_2 & D \end{bmatrix}.$$

Since we have two models (Δ, M) and $(\hat{\Delta}, M)$ we also have two feedback interconnections and also two sets of signals. We introduce the following notation for the laplace transformed signals:

$$\begin{bmatrix} z_1 \\ z_2 \\ y \end{bmatrix} = M \begin{bmatrix} x_1 \\ x_2 \\ u \end{bmatrix}, \quad \begin{bmatrix} \hat{z}_1 \\ \hat{z}_2 \\ \hat{y} \end{bmatrix} = M \begin{bmatrix} \hat{x}_1 \\ \hat{x}_2 \\ u \end{bmatrix}.$$

We assume that the initial conditions are zero. This is realistic since the two models are stable. Note that the input signal u is the same for both models.

Multiplying the inequality (4) with the vector $(x_1 + \hat{x}_1, x_2 + \hat{x}_2, 2u)$ from the right and its complex conjugate from the left, and adding this to the inequality obtained by multiplying the inequality (5) with the column vector $\sigma_2^{-1}(x_1 - \hat{x}_1, x_2 - \hat{x}_2)$ from the right and its complex conjugate from the left, we then get by noting that $z - \hat{z} = A(x - \hat{x})$, $y - \hat{y} = C(x - \hat{x})$ and using some matrix manipulations, the following inequality

$$\begin{aligned} 0 \geq & \begin{bmatrix} z_1 + \hat{z}_1 \\ x_1 + \hat{x}_1 \end{bmatrix}^* \Pi_1 \begin{bmatrix} z_1 + \hat{z}_1 \\ x_1 + \hat{x}_1 \end{bmatrix} \\ & + \sigma_1^2 \sigma_2^{-2} \begin{bmatrix} z_1 - \hat{z}_1 \\ x_1 - \hat{x}_1 \end{bmatrix}^* \Pi_1 \begin{bmatrix} z_1 - \hat{z}_1 \\ x_1 - \hat{x}_1 \end{bmatrix} \\ & + 2 \begin{bmatrix} z_2 \\ x_2 \end{bmatrix}^* \Pi_2 \begin{bmatrix} z_2 \\ x_2 \end{bmatrix} + 2 \begin{bmatrix} \hat{z}_2 \\ \hat{x}_2 \end{bmatrix}^* \Pi_2 \begin{bmatrix} \hat{z}_2 \\ \hat{x}_2 \end{bmatrix} \\ & + \sigma_2^{-2} |y - \hat{y}|^2 - 4|u|^2. \end{aligned}$$

The first and second term are nonnegative since $\Delta_1 = \hat{\Delta}_1$ satisfies the quadratic constraint defined by Π_1 and

$$x_1 + \hat{x}_1 = \Delta_1(z_1 + \hat{z}_1).$$

The third and fourth term are nonnegative since Δ_2 and $\hat{\Delta}_2$ both satisfy the quadratic constraint defined by Π_2 . This completes the proof for the case $\hat{r} + 1 = r = 2$.

More generally one can generate a sequence of new models by replacing $\Delta_r, \dots, \Delta_{\hat{r}+1}$ one at a time. At each step, the above argument can be used and the total error bound becomes

$$|(y - \hat{y})(i\omega)| < 2(\sigma_r(\omega) + \dots + \sigma_{\hat{r}+1}(\omega))|u(i\omega)|.$$

□

6. Numerical example

In this section we give an example where we illustrate both the use of other reduction methods than truncation and the importance of not restricting the set of multipliers more than necessary. We also indicate the advantage of not having to restrict the type of realization to *e.g.* a balanced realization.

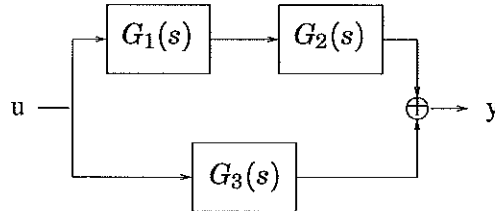

Figure 11 The model in the example.

Consider the model in Figure 11 where the transfer functions are

$$G_k(s) = \frac{1}{s\tau_k + 1}, \quad k = 1, 2, 3.$$

The time constants are $\tau_1 = 1$, $\tau_2 = 0.1$ and $\tau_3 = 0.01$. We may think of the transfer functions as representing components in a larger interconnected system. Assume that we are interested in knowing how large the error, at different frequencies, would be if we neglect the high frequency dynamics for some of the transfer functions *i.e.* assumes that $G_k(i\omega) \approx 1$. We may think of this as replacing an electrical component by a wire. The defined problem can not be studied using the results in Section 3 where only truncation corresponding to the approximation $G_k(i\omega) \approx 0$ is studied. Neither could singular perturbation approximation of the corresponding balanced realization be used since we have to keep the structure of the interconnected system.

To be able to apply the results in this report we rewrite the model on the form (Δ, M) . We let Δ contain the transfer functions considered for simplification and M the remaining part of the model. For example if we consider simplification of G_2 and G_3 then

$$\Delta = \text{diag}(\delta_2, \delta_3) = \text{diag}(G_2(s), G_3(s))$$

and

$$M(s) = \begin{bmatrix} 0 & 0 & G_1(s) \\ 0 & 0 & 1 \\ 1 & 1 & 0 \end{bmatrix}.$$

To simplify the dynamics corresponding to G_k we use $\hat{\delta}_k = \hat{G}_k = 1$ in the reduction formula (3).

We will now consider two cases. In the first case we describe the transfer functions as known transfer functions and in the second case we describe them as unity norm-bounded transfer functions.

In the first case, the multiplier Π_k describing the transfer function G_k , should satisfy both

$$\begin{bmatrix} 1 \\ G_k(i\omega) \end{bmatrix}^* \Pi_k(i\omega) \begin{bmatrix} 1 \\ G_k(i\omega) \end{bmatrix} \geq 0$$

and

$$\begin{bmatrix} 1 \\ 1 \end{bmatrix}^* \Pi_k(i\omega) \begin{bmatrix} 1 \\ 1 \end{bmatrix} \geq 0.$$

The first constraint corresponds to the original transfer function and the second to the simplified transfer function. These constraints on the multipliers are necessary and sufficient.

We now consider simplification of one of the transfer functions at a time. Using numerical calculations, see Section 8, we find the σ -functions in Figure 12. The corresponding error bounds $2\sigma_k$ are in these cases equal to the exact error. The exact error has in this simple case been calculated as

the difference between the transfer functions corresponding to the original and simplified models.

It is easy to understand why the error curves have the form shown in Figure 12. The approximation $G_3(s) \approx 1$ is accurate at low frequencies where $G_3(s) \approx 1$ but not at higher frequencies where $G_3(s) \approx 0$. The same idea can be used to understand why the curves for $\sigma_1(\omega)$ and $\sigma_2(\omega)$ are small at low frequencies. At high frequencies, however, the small values are explained by the low-pass character of the transfer functions in the series connection.

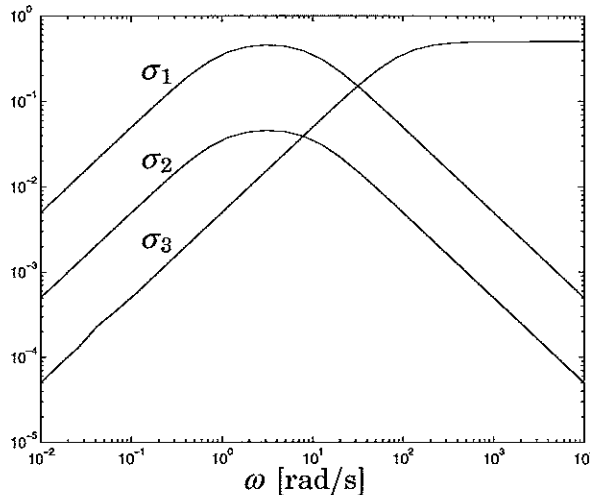

Figure 12 The σ_k -functions corresponding to the dynamics in $G_k(s)$. If the dynamics in $G_k(s)$ is neglected then the approximation error will be bounded by $2\sigma_k(\omega)$.

In the second case we describe the transfer function G_k using the multiplier

$$\Pi_k(i\omega) = \begin{bmatrix} x(\omega) & 0 \\ 0 & -x(\omega) \end{bmatrix}$$

where $x(\omega) \geq 0$ is a real valued function. This multiplier defines quadratic constraints satisfied by any unity norm-bounded transfer function and is, thus, a conservative description of our transfer function. Note that the simplified transfer function $\hat{\delta}_k = \hat{G}_k = 1$, also satisfies the quadratic constraint defined by this multiplier.

Using this multiplier when considering simplification of one block at the time we obtain the σ -functions in Figure 13. Comparing with Figure 12 we see that the σ -functions in Figure 13 give more conservative error bounds. This shows that it is important to allow as much freedom in the multiplier Π as possible, in order to obtain good error bounds.

We now return to the more accurate description and let Δ contain both the transfer functions G_2 and G_3 at the same time. Using the two step procedure, described in Section 8 we find the σ -functions in Figure 14. These σ -functions have higher values and thus result in more conservative error bounds when we consider simplification of one transfer function at the time, than the previously obtained. One possible reason for getting higher values is that the suboptimal two-step algorithm not necessarily give us

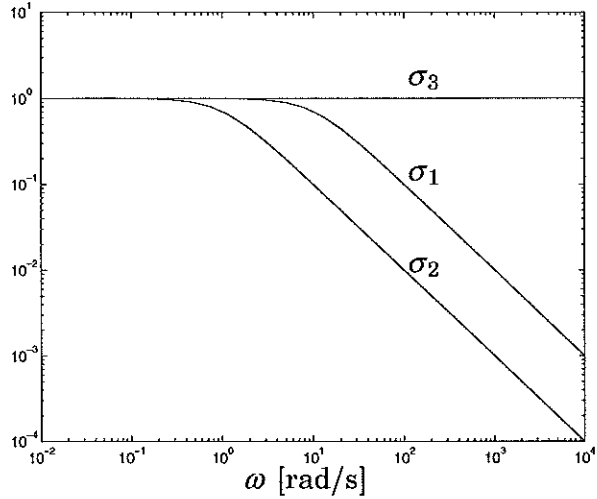

Figure 13 The σ_k -functions corresponding to the dynamics in $G_k(s)$, when a more conservative description is used.

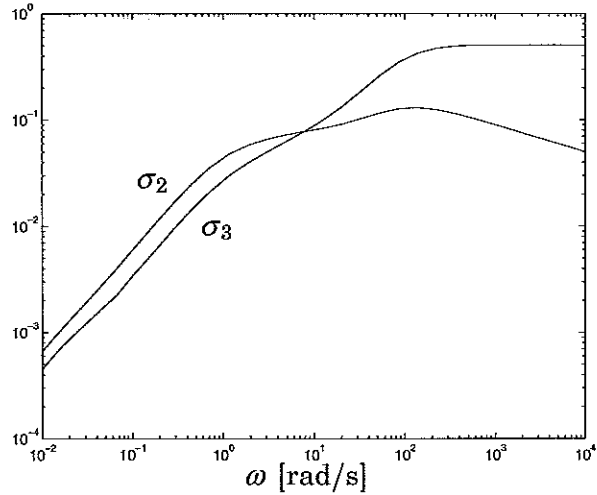

Figure 14 The σ -functions corresponding to the dynamics in $G_2(s)$ and $G_3(s)$, respectively. If the dynamics in both these transfer functions are neglected then the approximation error will be bounded by $2(\sigma_2(\omega) + \sigma_3(\omega))$.

the the best possible solution to the inequalities in Theorem 2, as it does in the one-block case. An other reason is that the σ_k values are expected to increase with the number of blocks in Δ when there is an interdependence between the blocks. This will be motivated in Section 7.3.

Finally we let Δ contain all the transfer functions at the same time. The suboptimal σ -functions are in this case shown in Figure 15. We see that the σ -functions in this case have even higher values.

The conclusions from this example are that it is important to describe the transfer function Δ as accurately as possible, *i.e.* use as much freedom as possible when the multipliers Π_k are chosen. Also one should only include in Δ the dynamics that are intended to be simplified. If these recommendations are violated the error bounds may be more conservative than necessary. On the other hand, if these recommendations are followed the method gives good error bounds for this example.

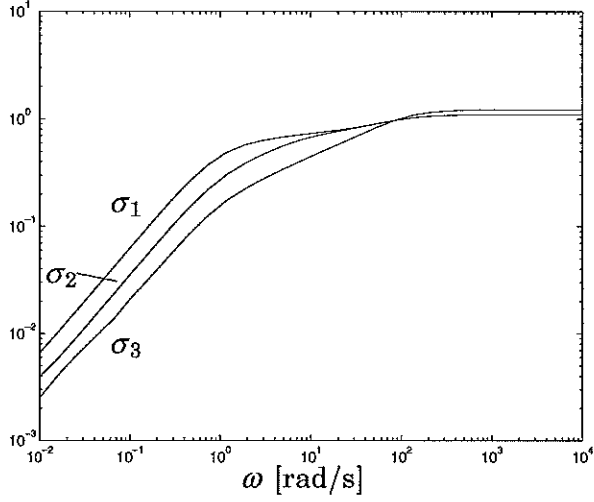

Figure 15 The σ -functions corresponding to the dynamics in $G_1(s)$, $G_2(s)$ and $G_3(s)$, respectively. If the dynamics in all these transfer functions are neglected then the approximation error will be bounded by $2(\sigma_1(\omega) + \sigma_2(\omega) + \sigma_3(\omega))$.

7. Some properties of the error bounds

In this section we obtain some properties of the error bounds associated with Theorem 2. It is shown that small error bounds can be found if Δ and $\hat{\Delta}$ are close to each other. It is also shown that the error bounds are optimal, in some cases, when Δ only contains one block, but that we expect the error bounds to become conservative as the number of blocks increases.

7.1 Small error bounds for small errors

The following theorem shows that we for any stable model (Δ, M) can make Σ , and thus the error bound, arbitrary small by restricting $\hat{\Delta}$ to be sufficiently close to Δ . This does in addition imply that the exact error is small when Δ and $\hat{\Delta}$ are close to each other, which was shown by a direct proof in Section 5.

THEOREM 3

Given any

$$M = \begin{bmatrix} A & B \\ C & D \end{bmatrix},$$

$$\Delta = \text{diag}(\Delta_1, \dots, \Delta_r),$$

$$\Sigma = \text{diag}(\sigma_1 I_{n_1}, \dots, \sigma_r I_{n_r}) > 0,$$

such that $I - A\Delta$ is invertible, there exist $\varepsilon > 0$ and $\lambda > 0$ such that

$$\Pi = -\lambda \begin{bmatrix} \Delta^* \\ -I \end{bmatrix} [\Delta \quad -I] + \lambda \varepsilon^2 \begin{bmatrix} I & 0 \\ 0 & 0 \end{bmatrix},$$

satisfies the conditions

$$\text{I.} \quad \begin{bmatrix} I \\ \hat{\Delta} \end{bmatrix}^* \Pi \begin{bmatrix} I \\ \hat{\Delta} \end{bmatrix} \geq 0, \quad \text{when} \quad \|\Delta - \hat{\Delta}\| \leq \varepsilon$$

$$\text{II.} \quad \begin{bmatrix} A & B \\ I & 0 \end{bmatrix}^* \Pi \begin{bmatrix} A & B \\ I & 0 \end{bmatrix} + \begin{bmatrix} 0 & 0 \\ 0 & -I \end{bmatrix} < 0 \quad (4)$$

$$\begin{bmatrix} \Sigma A \\ \Sigma \end{bmatrix}^* \Pi \begin{bmatrix} \Sigma A \\ \Sigma \end{bmatrix} + C^* C < 0. \quad (5)$$

Proof See Appendix. \square

Note that the invertibility condition holds if (Δ, M) is stable.

7.2 An optimality result

The error bounds obtainable using Theorem 2 are in some cases optimal, *i.e.* equal to the best possible upper bound. The best upper bound is defined as the worst possible error at each frequency. This means that there for each frequency exist values of $\Delta(i\omega)$ and $\hat{\Delta}(i\omega)$ such that the error is equal to the best possible upper bound.

The following theorem gives the best possible upper bound when Δ is a norm bounded real scalar.

THEOREM 4

Let Δ and $\hat{\Delta}$ be real scalars such that $|\Delta| \leq 1$ and $|\hat{\Delta}| \leq 1$, then

$$\sup_{\Delta, \hat{\Delta} \in [-1, 1]} \|\Delta \star M - \hat{\Delta} \star M\| = \begin{cases} \frac{2|C| \cdot |B|}{\sqrt{(1 - |A|^2)^2 + 4(\text{Im } A)^2}}, & |A| \leq 1 \\ \frac{|C| \cdot |B|}{|\text{Im } A|}, & |A| > 1 \end{cases}$$

and

$$\sup_{\Delta \in [-1, 1], \hat{\Delta} = 0} \|\Delta \star M - \hat{\Delta} \star M\| = \begin{cases} \frac{|C| \cdot |B|}{\sqrt{(1 - |\text{Re } A|^2)^2 + (\text{Im } A)^2}}, & |\text{Re } A| \leq 1, \\ \frac{|C| \cdot |B|}{|\text{Im } A|}, & |\text{Re } A| > 1. \end{cases}$$

Proof See Appendix. \square

The theorem below shows, for the same case, the obtainable error bound using Theorem 2.

THEOREM 5

Let Δ and $\hat{\Delta}$ be real scalars with $|\Delta| \leq 1$ and $|\hat{\Delta}| \leq 1$, then they satisfy any quadratic constraint defined by

$$\Pi = \begin{bmatrix} x & iy \\ -iy & -x \end{bmatrix},$$

where $x \geq 0$ is real and y is real. There exist a Π with the above structure, satisfying inequalities (4) and (5), if and only if

$$2\sigma > \begin{cases} \frac{2|C| \cdot |B|}{\sqrt{(1 - |A|^2)^2 + 4(\text{Im } A)^2}}, & |A| \leq 1 \\ \frac{|C| \cdot |B|}{|\text{Im } A|}, & |A| > 1. \end{cases}$$

Proof See Appendix. □

Based on these theorems we conclude that the error bounds obtainable using Theorem 2 are optimal when Δ and $\hat{\Delta}$ are assumed to be any norm bounded real scalars. Similar results have also been obtained when Δ and $\hat{\Delta}$ are positive real scalars.

7.3 Some indications of conservatism

We have seen above that the error bounds obtainable using Theorem 2 are optimal in some one block cases. If the number of blocks increases, however, this optimality property is not expected to be preserved. We present two reasons that indicate this.

If there is an inter-dependence between the blocks in Δ then this is not taken into account by the method. This indicates that the error bounds in this case may be conservative. A priori applied coordinate transformations may therefore be valuable in order to obtain less conservative error bounds, but do at the same time change the structure of the model. This change of coordinates may be undesirable, for example if the elements in M have a physical interpretation.

The second reason is that the σ_k values are expected to increase with the number of blocks in Δ , since each σ_k -value should be used to calculate more than one upper bound. If we simplify one block then σ_k is used in the error bound $2\sigma_k$, which must hold independent of how many blocks there are in Δ . We therefore do not expect σ_k to decrease with the number of blocks in Δ . On the other hand if we increase the number of blocks in Δ then the function σ_k should be used to calculate more and more upper bounds. The σ_k -values may then have to be increased. The following example illustrates the idea.

EXAMPLE 5

Consider the function

$$f(\delta_1, \delta_2, \delta_3) = (\delta_1 - \delta_2)(\delta_1 - \delta_3),$$

defined for $|\delta_k| \leq 1$. Think of each δ_k as a transfer function and the function f as the input-output relation of a model. Assume that the nominal model is given by $G(\delta) = f(\delta, \delta, \delta) = 0$ and consider the following three simplified models,

$$\begin{aligned}\hat{G}_2(\delta) &= f(\delta, \hat{\delta}_2, \delta) = 0, \\ \hat{G}_3(\delta) &= f(\delta, \delta, \hat{\delta}_3) = 0, \\ \hat{G}_{23}(\delta) &= f(\delta, \hat{\delta}_2, \hat{\delta}_3) = (\delta - \hat{\delta}_2)(\delta - \hat{\delta}_3).\end{aligned}$$

We see that replacing only one of the transfer functions δ_2 and δ_3 does not result in any input-output error. If we on the other hand replace both δ_2 and δ_3 then the error satisfies

$$|G - \hat{G}_{23}| = |\hat{G}_{23}| \leq 4,$$

where the bound is reached for $\hat{\delta}_2 = \hat{\delta}_3 = -\delta = \pm 1$.

This shows that the error when we replace more than one component of a model may be larger than the sum of the errors for replacing one

component. This indicates that it may be necessary to increase the value on σ_k when the number of blocks considered for replacement is increased. \square

8. Numerical computation

In this section we describe numerical computation of scalars $\sigma_k(\omega)$ satisfying the inequalities in Theorem 2. The computations are described for a given frequency ω , and must thus be repeated for each frequency of interest.

Introduce the matrices

$$\begin{aligned}\Sigma(\omega) &= \text{diag}(\sigma_1(\omega)I_{n_1}, \dots, \sigma_r(\omega)I_{n_r}) > 0, \\ \Pi(i\omega) &= \text{diag}(\Pi_1(i\omega), \dots, \Pi_r(i\omega)).\end{aligned}$$

The inequalities in Theorem 2 may then be written as

$$\begin{aligned}\begin{bmatrix} A(i\omega) & B(i\omega) \\ I & 0 \end{bmatrix}^* \Pi(i\omega) \begin{bmatrix} A(i\omega) & B(i\omega) \\ I & 0 \end{bmatrix} &< \begin{bmatrix} 0 & 0 \\ 0 & I \end{bmatrix}, \\ \begin{bmatrix} A(i\omega) \\ I \end{bmatrix}^* \begin{bmatrix} \Sigma^2(\omega) & 0 \\ 0 & \Sigma^2(\omega) \end{bmatrix} \Pi(i\omega) \begin{bmatrix} A(i\omega) \\ I \end{bmatrix} + C(i\omega)^* C(i\omega) &< 0.\end{aligned}$$

The scalars $\sigma_k(\omega)$ satisfying these inequalities are not unique. This makes it necessary to introduce an optimization criteria. Since the values of $\sigma_k(\omega)$ should be small, in order to obtain low error bounds, one may choose to minimize the trace of Σ .

There are many matrices $\Pi(i\omega)$ defining quadratic constraints satisfied by both $\Delta(i\omega)$ and $\hat{\Delta}(i\omega)$, and which thus could be used. Assume that we select one of these a priori, then the inequalities become linear matrix inequalities in $\Sigma^2(\omega)$. A $\Sigma(\omega)$ with minimal trace can then be found numerically using for example the LMI control toolbox, [8].

The obtainable values on $\sigma_k(\omega)$, and thus the error bound, depend strongly on the choice of $\Pi(i\omega)$. The above described approach does therefore in general not seem reasonable. Instead we allow $\Pi(i\omega)$ to belong to a set described by linear matrix inequalities and minimize the trace of $\Sigma(\omega)$ not only *w.r.t* $\Sigma(\omega) > 0$ but also *w.r.t* $\Pi(i\omega)$. The obtained problem is in general non-convex and difficult to solve. The following suboptimal two step algorithm is therefore proposed.

Step 1 Let $\Sigma_0(\omega)$ be an initial guess for $\Sigma(\omega)$. Find an allowable $\Pi(i\omega)$ that minimizes $\gamma(\omega)$ under the constraints

$$\begin{aligned}\gamma^2(\omega) \begin{bmatrix} A(i\omega) \\ I \end{bmatrix}^* \begin{bmatrix} \Sigma_0(\omega)^2 & 0 \\ 0 & \Sigma_0(\omega)^2 \end{bmatrix} \Pi(i\omega) \begin{bmatrix} A(i\omega) \\ I \end{bmatrix} + C^*(i\omega)C(i\omega) &< 0, \\ \begin{bmatrix} A(i\omega) & B(i\omega) \\ I & 0 \end{bmatrix}^* \Pi(i\omega) \begin{bmatrix} A(i\omega) & B(i\omega) \\ I & 0 \end{bmatrix} &< \begin{bmatrix} 0 & 0 \\ 0 & I \end{bmatrix}.\end{aligned}$$

Step 2 Let $\Pi(i\omega)$ be the solution obtained in Step 1. Find $\Sigma(\omega)$ that minimizes $\text{tr} \Sigma(\omega)^2$ under the constraint

$$\begin{bmatrix} A(i\omega) \\ I \end{bmatrix}^* \begin{bmatrix} \Sigma^2(\omega) & 0 \\ 0 & \Sigma^2(\omega) \end{bmatrix} \Pi(i\omega) \begin{bmatrix} A(i\omega) \\ I \end{bmatrix} + C^*(i\omega)C(i\omega) < 0.$$

Note that this algorithm may end up in local minimas. The initial choice $\Sigma_0(\omega)$ may therefore be important. In the case where $\Delta(i\omega)$ only contains one block, it is easy to verify that the algorithm will result in the best possible value on σ . (This does, however, not necessarily mean that we find the best possible error bound.)

The algorithm may be modified. It is *e.g.* possible to use different weights for different blocks instead of minimizing the trace. It is also possible to use the algorithm for iteration. Then $\Sigma(\omega)$ obtained in Step 2 replaces $\Sigma_0(\omega)$ in Step 1 when a new iteration begins. When the computations are done for frequencies close to each other it may be possible to increase the efficiency by choosing the initial guess Σ_0 close to a previously calculated Σ .

9. Conclusions

In this report we have derived upper bounds on the error between two uncertain linear time-invariant models. The results can be used to analyze the importance of different components of a model and for model reduction.

The obtained error bounds are frequency dependent which is an important feature in many applications such as controller design where different frequencies have different importance.

Appendix – Proofs of error bound properties

This appendix contains the proofs of the results in Section 7.

Proof of Theorem 3

Consider the multiplier Π defined in the theorem. The first condition holds since

$$\frac{1}{\lambda} \begin{bmatrix} I \\ \hat{\Delta} \end{bmatrix}^* \Pi \begin{bmatrix} I \\ \hat{\Delta} \end{bmatrix} = -(\Delta - \hat{\Delta})^*(\Delta - \hat{\Delta}) + \varepsilon^2.$$

The second condition is first shown for $\varepsilon = 0$. The multiplier Π does in this case satisfy inequality (4) for any $\lambda > 0$ since

$$\begin{aligned} & \begin{bmatrix} A & B \\ I & 0 \end{bmatrix}^* \Pi \begin{bmatrix} A & B \\ I & 0 \end{bmatrix} + \begin{bmatrix} 0 & 0 \\ 0 & -I \end{bmatrix} \\ = & \begin{bmatrix} -\lambda(I - \Delta A)^*(I - \Delta A) & \lambda(I - \Delta A)^*\Delta B \\ \lambda(\Delta B)^*(I - \Delta A) & -\lambda(\Delta B)^*\Delta B - I \end{bmatrix} < 0 \\ \Leftrightarrow & \\ & \begin{bmatrix} -\lambda(I - \Delta A)^*(I - \Delta A) & 0 \\ 0 & -I \end{bmatrix} < 0, \end{aligned}$$

where the last equivalence follows using the Schur complement

$$-\lambda(\Delta B)^* \Delta B - I + \lambda(\Delta B)^*(I - \Delta A) \cdot \{\lambda(I - \Delta A)^*(I - \Delta A)\}^{-1} \lambda(I - \Delta A)^* \Delta B = -I.$$

The inequality (5) for any given $\Sigma > 0$ is satisfied by the multiplier Π (when $\varepsilon = 0$) if λ is chosen sufficiently large. This follows by the following arguments.

$$\begin{aligned} & \begin{bmatrix} \Sigma A \\ \Sigma \end{bmatrix}^* \Pi \begin{bmatrix} \Sigma A \\ \Sigma \end{bmatrix} + C^* C \\ &= -(\Delta A - I)^* \Sigma \lambda \Sigma (\Delta A - I) + C^* C. \end{aligned}$$

Since $\Sigma > 0$ and $\Delta A - I$ has full rank we see that we can make the expression negative by choosing λ sufficiently large.

We have so far shown that for any Σ , no matter how small, our Π , with $\varepsilon = 0$ and λ chosen sufficiently large, defines a quadratic constraint satisfied by $\hat{\Delta} = \Delta$ and it also satisfies inequalities (4) and (5). This shows that the error bound can be made arbitrary small when the compared models are equal.

Finally, since the expressions in the two inequalities (4) and (5) are continuous in the matrix elements it follows that sufficiently small changes in Π do not affect the negative definiteness of the inequalities. Thus, the inequalities will be satisfied for a sufficiently small $\varepsilon > 0$.

Proof of Theorem 4

It holds that

$$\|\hat{\Delta} \star M - \Delta \star M\| = |CB| \sqrt{f(\Delta, \hat{\Delta})}$$

where

$$\begin{aligned} f(\Delta, \hat{\Delta}) &= \left| \frac{\hat{\Delta} - \Delta}{(1 - A\hat{\Delta})(1 - A\Delta)} \right|^2 = \\ &= \frac{(\hat{\Delta} - \Delta)^2}{[(1 - \hat{\Delta} \operatorname{Re} A)^2 + (\hat{\Delta} \operatorname{Im} A)^2][(1 - \Delta \operatorname{Re} A)^2 + (\Delta \operatorname{Im} A)^2]}. \end{aligned}$$

The maximum of this function should be found. First consider local maximas. It holds that

$$\frac{\partial f}{\partial \Delta} = 0 \quad \Leftrightarrow \quad \frac{\partial f}{\partial \hat{\Delta}} = 0 \quad \Leftrightarrow \quad 1 - \hat{\Delta} \operatorname{Re} A - \Delta \operatorname{Re} A + \Delta \hat{\Delta} |A|^2 = 0$$

in which case

$$f = \frac{1}{(\operatorname{Im} A)^2}.$$

Local maximas in the set $|\Delta| \leq 1, |\hat{\Delta}| \leq 1$ can be found precisely when $|A| \geq 1$, and in the set $|\Delta| \leq 1, \hat{\Delta} = 0$ when $|\operatorname{Re} A| \geq 1$.

In addition to local maximas we must also consider points on the boundary. Since the partial derivatives of f with respect to Δ and $\hat{\Delta}$ are zero simultaneously it is sufficient to consider corners on the boundary. Other candidates show up as local maximas. The corner points are

$$f(1, 1) = f(-1, -1) = 0$$

$$f(1, -1) = f(-1, 1) = \frac{4}{(1 - |A|^2)^2 + 4|\operatorname{Im} A|^2}$$

and

$$f(1, 0) = \frac{1}{(1 - \operatorname{Re} A)^2 + (\operatorname{Im} A)^2}$$

$$f(-1, 0) = \frac{1}{(1 + \operatorname{Re} A)^2 + (\operatorname{Im} A)^2},$$

respectively. This completes the proof.

Proof of Theorem 5

First introduce the notation

$$x_0 = \frac{1 - |A|^2}{2|B|^2}, \quad y_0 = -\frac{\operatorname{Im} A}{|B|^2},$$

and

$$R = \sqrt{x_0^2 + y_0^2} = \frac{\sqrt{(1 - |A|^2)^2 + 4|\operatorname{Im} A|^2}}{2|B|^2}.$$

Inequality (4) can then, by noting that $\operatorname{Re} iyA^* = y \operatorname{Im} A$, and using Schur complements, be rewritten as follows

$$\begin{aligned} & \begin{bmatrix} A^* & 1 \\ B^* & 0 \end{bmatrix} \begin{bmatrix} x & iy \\ -iy & -x \end{bmatrix} \begin{bmatrix} A & B \\ 1 & 0 \end{bmatrix} - \begin{bmatrix} 0 & 0 \\ 0 & 1 \end{bmatrix} < 0 \\ & \iff \\ & \begin{bmatrix} A^*xA - iyA + iyA^* - x & A^*xB - iyB \\ B^*xA + iyB^* & B^*xB - 1 \end{bmatrix} < 0 \\ & \iff \\ & (|A|^2 - 1)x + 2y \cdot \operatorname{Im} A + \frac{|B|^2}{1 - |B|^2x} (x^2|A|^2 + y^2 + 2xy \cdot \operatorname{Im} A) < 0 \\ & \qquad \qquad \qquad |B|^2x - 1 < 0. \\ & \iff \\ & (x - x_0)^2 + (y - y_0)^2 < R^2 \\ & \qquad \qquad \qquad |B|^2x - 1 < 0 \\ & \iff \\ & (x - x_0)^2 + (y - y_0)^2 < R^2. \end{aligned}$$

The last equivalence follows since it holds that

$$x < x_0 + R \leq \frac{1 - |A|^2 + \sqrt{(1 - |A|^2)^2 + 4|A|^2}}{2|B|^2} = \frac{1}{|B|^2}$$

as soon as the circle constraint is satisfied.

Inequality (5) is given by

$$\begin{aligned} [A^* \quad 1] \begin{bmatrix} x & iy \\ -iy & -x \end{bmatrix} \begin{bmatrix} A \\ 1 \end{bmatrix} + \frac{1}{\sigma^2} C^* C < 0 \\ \Leftrightarrow \\ (|A|^2 - 1)x + 2y \operatorname{Im} A + \frac{1}{\sigma^2} |C|^2 < 0 \\ \Leftrightarrow \\ \frac{|C|^2}{2\sigma^2 |B|^2} < x_0 x + y_0 y. \end{aligned}$$

To allow σ to become small we should find the supremum of the function $f(x, y) = x_0 x + y_0 y$ under the circle constraint as well as the constraint $x \geq 0$. Since f is linear in x and y it follows that the supremum is found on the boundary. On the circle, parameterized as

$$x = x_0 + R \cos \phi, \quad y = y_0 + R \sin \phi,$$

it holds that

$$f(x, y) = x_0 x + y_0 y = R^2 + R x_0 \cos \phi + R y_0 \sin \phi.$$

The extremas are found when

$$\tan \phi = \frac{y_0}{x_0}.$$

This corresponds to two possibilities $(x, y) = (0, 0)$ and $(x, y) = (2x_0, 2y_0)$ with function values 0 and $2R^2$, respectively. The maximum when $x_0 \geq 0$ will therefore be $2R^2$. If $x_0 < 0$ then the maximum will be obtained at the intersection of the circle and the line $x = 0$. The maximum of the intersection points is at $(x, y) = (0, 2y_0)$ where $f = 2y_0^2$. This completes the proof.

References

- [1] U. AL-SAGGAF and G. FRANKLIN. "An error bound for a discrete reduced order model of a linear multivariable system." *IEEE Transactions on Automatic Control*, **32:9**, pp. 815–819, September 1987.
- [2] L. ANDERSSON and C. BECK. "Model comparison and simplification." In *35th IEEE CDC Proceedings*, Kobe, Japan, 1996.
- [3] C. BECK. *Model Reduction and Minimality for Uncertain Systems*. PhD thesis, California Institute of Technology, 1996.
- [4] C. BECK, J. DOYLE, and K. GLOVER. "Model reduction of multidimensional and uncertain systems." *IEEE Transaction on Automatic Control*, **41:10**, pp. 1466–1477, 1996.
- [5] D. ENNS. *Model Reduction for Control System Design*. PhD thesis, Stanford University, 1984.

- [6] K. FERNANDO and H. NICHOLSON. "Singular perturbational model reduction in the frequency domain." *IEEE Transactions on Automatic Control*, **27**, pp. 969–970, 1982.
- [7] K. FERNANDO and H. NICHOLSON. "Singular perturbational model reduction of balanced systems." *IEEE Transactions on Automatic Control*, **27**, pp. 466–468, 1982.
- [8] G. GAHINET, A. NEMIROVSKI, A. LAUB, and M. CHILALI. *LMI Control Toolbox*. The Math Works Inc., 1995.
- [9] K. GLOVER. "All optimal hankel-norm approximations of linear multivariable systems and their L^∞ -error bounds," *Int. J. Control.*, **39**, pp. 1115–1193, 1984.
- [10] D. HINRICHSSEN and A. PRITCHARD. "An improved error estimate for reduced order models of discrete-time systems." *IEEE trans. on Automatic Control*, **35**, pp. 317–320, 1990.
- [11] Y. LIU and B. D. O. ANDERSON. "Singular perturbation approximation of balanced systems." *Int. Journal of Control*, **50**, pp. 1379–1405, 1989.
- [12] B. MOORE. "Principal component analysis in linear systems: Controllability, observability and model reduction." *IEEE Trans. on Automatic Control*, **26**, pp. 17–32, 1981.
- [13] L. PERNEBO and L. SILVERMAN. "Model reduction via balanced state space representations." *IEEE Trans. on Automatic Control*, **27:2**, pp. 382–387, 1982.
- [14] A. RANTZER. "Error bounds for nonlinear model truncation." Presented at Bernoulli Workshop, Groningen, 1995.
- [15] W. WANG, J. DOYLE, C. BECK, and K. GLOVER. "Model reduction of LFT systems." In *30th CDC Proceedings*, 1991.
- [16] K. ZHOU, J. DOYLE, and K. GLOVER. *Robust and Optimal Control*. Prentice-Hall, 1996.

