



LUND UNIVERSITY

Relay Feedback and Multivariable Control

Johansson, Karl Henrik

1997

Document Version:

Publisher's PDF, also known as Version of record

[Link to publication](#)

Citation for published version (APA):

Johansson, K. H. (1997). *Relay Feedback and Multivariable Control*. [Doctoral Thesis (compilation), Department of Automatic Control]. Department of Automatic Control, Lund Institute of Technology (LTH).

Total number of authors:

1

General rights

Unless other specific re-use rights are stated the following general rights apply:

Copyright and moral rights for the publications made accessible in the public portal are retained by the authors and/or other copyright owners and it is a condition of accessing publications that users recognise and abide by the legal requirements associated with these rights.

- Users may download and print one copy of any publication from the public portal for the purpose of private study or research.
- You may not further distribute the material or use it for any profit-making activity or commercial gain
- You may freely distribute the URL identifying the publication in the public portal

Read more about Creative commons licenses: <https://creativecommons.org/licenses/>

Take down policy

If you believe that this document breaches copyright please contact us providing details, and we will remove access to the work immediately and investigate your claim.

LUND UNIVERSITY

PO Box 117
221 00 Lund
+46 46-222 00 00

Relay Feedback and Multivariable Control

Karl Henrik Johansson

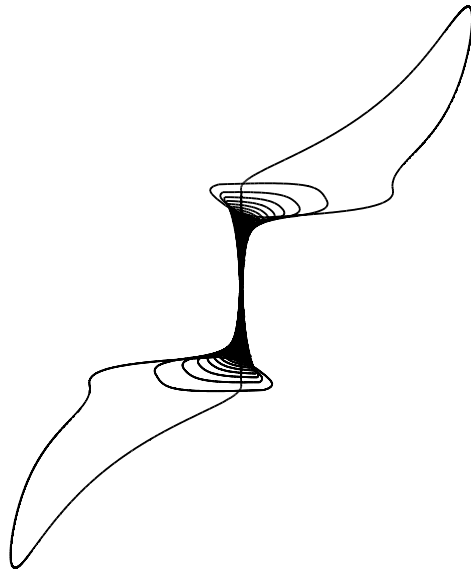

Department of Automatic Control, Lund Institute of Technology

Department of Automatic Control Lund Institute of Technology Box 118 S-221 00 Lund Sweden		<i>Document name</i> DOCTORAL DISSERTATION	
		<i>Date of issue</i> October 1997	
		<i>Document Number</i> ISRN LUTFD2/TFRT-1048--SE	
<i>Author(s)</i> Karl Henrik Johansson		<i>Supervisor</i> Karl Johan Åström and Anders Rantzer	
		<i>Sponsoring organisation</i> Swedish Research Council for Engineering Sciences (TFR) under contract 95-759	
<i>Title and subtitle</i> Relay feedback and multivariable control			
<i>Abstract</i> <p>This doctoral thesis treats three issues in control engineering related to relay feedback and multivariable control systems.</p> <p>Linear systems with relay feedback is the first topic. Such systems are shown to exhibit several interesting behaviors. It is proved that there exist multiple fast relay switches if and only if the sign of the first non-vanishing Markov parameter of the linear system is positive. It is also shown that these fast switches can appear as part of a stable limit cycle. A linear system with pole excess one or two is demonstrated to be particularly interesting. Stability conditions for these cases are derived. It is also discussed how fast relay switches can be approximated by sliding modes.</p> <p>Performance limitations in linear multivariable control systems is the second topic. It is proved that if the top left submatrices of a stable transfer matrix have no right half-plane zeros and a certain high-frequency condition holds, then there exists a diagonal stabilizing feedback that makes a weighted sensitivity function arbitrarily small. Implications on control structure design and sequential loop-closure are given. A novel multivariable laboratory process is also presented. Its linearized dynamics have a transmission zero that can be located anywhere on the real axis by simply adjusting two valves. This process is well suited to illustrate many issues in multivariable control, for example, control design limitations due to right half-plane zeros.</p> <p>The third topic is a combination of relay feedback and multivariable control. Tuning of individual loops in an existing multivariable control system is discussed. It is shown that a specific relay feedback experiment can be used to obtain process information suitable for performance improvement in a loop, without any prior knowledge of the system dynamics. The influence of the loop retuning on the overall closed-loop performance is derived and interpreted in several ways.</p>			
<i>Key words</i> Relay feedback; Sliding modes; Oscillations; Limit cycles; Nonlinear dynamics; Hybrid control; Multivariable systems; Multivariable zero; Decentralized control; Performance limitations; Laboratory process; Control education; Automatic tuning; Sequential control; Process control; Frequency methods			
<i>Classification system and/or index terms (if any)</i>			
<i>Supplementary bibliographical information</i>			
<i>ISSN and key title</i> 0280-5316		<i>ISBN</i>	
<i>Language</i> English	<i>Number of pages</i> 176	<i>Recipient's notes</i>	
<i>Security classification</i>			

The report may be ordered from the Department of Automatic Control or borrowed through:
 University Library 2, Box 3, S-221 00 Lund, Sweden
 Fax +46 46 222 44 22 E-mail ub2@ub2.lu.se

Relay Feedback and Multivariable Control

The figure on the cover shows a limit cycle for a relay feedback system. The plot is logarithmically scaled. Stability of the limit cycle is analyzed in Example 3 in Paper 2.

Relay Feedback and Multivariable Control

Karl Henrik Johansson

Lund 1997

To Liselott

Published by
Department of Automatic Control
Lund Institute of Technology
Box 118
S-221 00 LUND
Sweden

ISSN 0280-5316
ISRN LUTFD2/TFRT--1048--SE

©1997 by Karl Henrik Johansson
All rights reserved

Printed in Sweden by Lunds Offset AB
Lund 1997

Contents

Preface	vii
Thesis Outline and Publication History	viii
Acknowledgments	xii
Introduction	1
1. Multivariable Systems	2
2. Performance Limitations	11
3. Properties of Relay Feedback Systems	23
4. Automatic Tuning Using Relay Feedback	31
5. References	38
1. Fast Switches in Relay Feedback Systems	47
1. Introduction	48
2. Preliminaries	49
3. Stability of Limit Cycles	51
4. Existence of Fast Switches	56
5. Nature of Fast Switches	61
6. Fast Switches in Limit Cycles	67
7. Conclusions	76
8. References	76
2. Limit Cycles with Chattering in Relay Feedback Systems	79
1. Introduction	80
2. Sliding Modes	81
3. Chattering	83
4. Stability of Limit Cycles	86
5. Conclusions	92
6. References	92
Appendix	94
3. Performance Limitations in Multi-Loop Control Systems	101
1. Introduction	102
2. Preliminaries	103
3. Sequentially Minimum Phase	105
4. Right Half-Plane Zeros	108
5. Zeros and Sequential Loop-Closure	109
6. Conclusions	112
7. References	113
Appendix	114

4. A Multivariable Process with an Adjustable Zero	119
1. Introduction	120
2. Physical Model	121
3. System Identification	127
4. Multi-Loop Control	130
5. Conclusions	133
6. References	133
5. Multivariable Controller Tuning	137
1. Introduction	138
2. Loop Tuning	140
3. Relay Experiment	146
4. Example	150
5. Conclusions	152
6. References	154
Concluding Remarks	157
1. Main Contribution	157
2. Ideas for Future Work	158
3. References	161
4. Coauthor Affiliations	162

Preface

A conversation heard at a bar in Newcastle, Australia, between a Swedish graduate student and a local sailor:

- I'm doing research in control.
- What kind of control?
- Automatic control.
- Automatic control of what?
- Oh, of everything. It's a general theory.

The essence of control theory is its vast applicability, with a focus on system theory but not restricted to certain physical or intellectual objects. It has applications in many and diverse areas, such as chemical process control, economics, robotics, medicine, and aeronautics. This makes control engineering a challenging and interesting subject to study (although occasionally hard to explain to the uninitiated).

This thesis presents and solves some problems that, at a first glance, might look quite separated. I therefore start with a short story to explain their relations and why I started to investigate them.

The automatic tuning method for PID controllers based on relay feedback was developed in Lund during the eighties. The method has been successful in a large variety of industrial applications and has resulted in several patents. It was a natural question to ask if it was possible to extend the automatic tuning method to multivariable controllers. I was posed this question when I began my doctoral studies. Quite soon it became apparent that there were many unsolved problems related to the methodology; problems of both a theoretical and practical nature. They could roughly be put into two categories: (1) those related to the existence of oscillations and other behaviors in relay feedback systems and (2) those related to how multivariable control design could be automated.

I found that such a simple structure as a scalar linear system connected with a sign function in a feedback loop could show a quite complicated, and fascinating, behavior. Analysis of this resulted in further insight, particularly in the fast actions of these systems. This is presented in the thesis as Paper 1 and Paper 2. The nature of the results are such that they probably have little effect on the development of automatic tuning methods, but the results are certainly a contribution to the understanding of systems with combined continuous and discrete states. Many physical

systems have this hybrid nature and it is often imposed on the controller, for example in supervised control systems.

Multivariable control is difficult to use in practice. The reason for this is that many theoretical and practical problems related to modeling, design, and implementation are not solved. One approach is to use different methods depending on the process dynamics. It is reasonable to classify processes as “simple” or “difficult.” I did this and I also looked for ways to judge if the control structure could be simplified for some systems without considerable loss of closed-loop performance. This led to the result in Paper 3, where it is shown that some systems are particularly easy to control even with the simplest type of multivariable controller. The location of the multivariable zeros are shown to affect the achievable control performance. To further highlight this I developed a new laboratory process that has a movable zero. This process is presented in Paper 4. Finally, a method based on relay feedback experiments was derived for tuning individual loops in a multivariable system. Paper 5 shows how such experiments can be performed and what type of information they give. This work was motivated by the lack of multivariable control design methods that account for practical constraints such as modeling and implementation efficiency.

Thesis Outline and Publication History

The thesis consists of an introduction, five papers, and some concluding remarks. Most of the results presented in the papers have been published in refereed conference proceedings and are now under review for journal publication. The contents of each part of the thesis are briefly given in the following together with references to publications.

Paper 1—Fast switches in relay feedback systems

Linear systems with relay feedback are studied in this paper. It is proved that there exists multiple fast relay switches if and only if the sign of the first non-vanishing Markov parameter of the linear system is positive. It is also shown that these fast switches can occur as part of stable limit cycles. Examples with pole excess one, two, and three are presented. A regular sliding mode can appear as part of the limit cycle for systems with pole excess one. For pole excess two there will be many fast switches instead of a sliding mode. Only a few fast switches appear for pole excess three. The reasons for these behaviors are explained in the paper. Through an example from the literature, it is also illustrated that approximating the relay by a saturation with a steep slope can give erroneous results if it is not done properly.

The paper is submitted for journal publication as

JOHANSSON, K. H., A. RANTZER, and K. J. ÅSTRÖM (1997): “Fast switches in relay feedback systems.” Submitted for journal publication.

Some results limited to third-order systems have been published as

JOHANSSON, K. H. and A. RANTZER (1996): “Global analysis of third-order relay feedback systems.” In *Preprints 13th IFAC World Congress*, vol. E, pp. 55–60. San Francisco, CA.

JOHANSSON, K. H. and A. RANTZER (1996): “Global analysis of third-order relay feedback systems.” Report ISRN LUTFD2/TFRT--7542--SE. Department of Automatic Control, Lund Institute of Technology, Lund, Sweden.

JOHANSSON, K. H. and A. RANTZER (1995): “Limit cycles in relay feedback systems.” In *2nd Russian-Swedish Control Conference, St. Petersburg, Russia*.

Paper 2—Limit cycles with chattering in relay feedback systems

This paper is a continuation of Paper 1. It presents a detailed analysis of linear systems with pole excess one and two under relay feedback. Fast relay switching instead of a sliding mode appears for pole excess two. This is denoted *chattering*. It is shown that chattering can be approximated by a sliding mode. Stability is proved for limit cycles with chattering. The stability condition follows as a nontrivial modification of a similar result for limit cycles with exact sliding modes.

The paper is submitted for journal publication as

JOHANSSON, K. H., A. BARABANOV, and K. J. ÅSTRÖM (1997): “Limit cycles with chattering in relay feedback systems.” Submitted for journal publication.

but exists also in the shorter conference version

JOHANSSON, K. H., A. BARABANOV, and K. J. ÅSTRÖM (1997): “Limit cycles with chattering in relay feedback systems.” Accepted for publication in *Proc. 36th IEEE Conference on Decision and Control*. San Diego, CA.

Paper 3—Performance limitations in multi-loop control systems

The effects of open-loop zeros on the achievable performance in a linear multivariable control system are studied in this paper. The notion of *sequentially minimum phase* is introduced. It means that all the top left submatrices of a transfer matrix are minimum phase. It is shown that if

Preface

a stable system is sequentially minimum phase and has a certain high-frequency structure, it can be controlled arbitrarily tight by diagonal feedback. Implications on control structure design and sequential loop-closure are also given.

The paper is submitted for journal publication as

JOHANSSON, K. H. and A. RANTZER (1997): "Performance limitations in multi-loop control systems." Submitted for journal publication.

One part of the paper has also been published as

JOHANSSON, K. H. and A. RANTZER (1997): "Multi-loop control of minimum phase processes." In *Proc. 16th American Control Conference*. Albuquerque, NM.

and some related results on performance limitations were presented as

JOHANSSON, K. H. (1996): "Performance limitations in coordinated control." In *EURACO Workshop on Robust and Adaptive Control of Integrated Systems*. Munich, Germany.

Paper 4—A multivariable process with an adjustable zero

This paper presents a new laboratory process that has been developed in order to illustrate some ideas presented in the thesis. The process is a quadruple-tank process with two inputs and two outputs. It has interesting dynamics and can be used to illustrate many ideas in multivariable control. A physical nonlinear model is derived and linearized. The corresponding 2×2 transfer matrix is shown to have two finite transmission zeros. One of them is located in the left half-plane and the other can be positioned anywhere on the real axis by simply adjusting a valve. This makes the quadruple-tank process suitable for illustrating control limitations due to nonminimum phase zeros, as those discussed in Paper 3. System identification and multi-loop control of the process are demonstrated in the paper.

The paper is submitted to a conference as

JOHANSSON, K. H. and J. L. R. NUNES (1997): "A multivariable laboratory process with an adjustable zero." Submitted to *17th American Control Conference*. Philadelphia, PA.

Paper 5—Multivariable controller tuning

This paper discusses how the performance of an existing multivariable control system can be improved. It is shown that a specific relay feedback experiment can be used to obtain suitable process information. The influence of loop retuning on the overall closed-loop performance is also

derived and interpreted in several ways. The paper ends with an application to a model of the quadruple-tank process presented in Paper 4. The proposed method measures how difficult it is to control the process for one minimum phase and one nonminimum phase setup.

The paper is submitted to a conference as

JOHANSSON, K. H., B. JAMES, G. F. BRYANT, and K. J. ÅSTRÖM (1997): "Multivariable controller tuning." Submitted to *17th American Control Conference*. Philadelphia, PA.

A preliminary version was presented as

JOHANSSON, K. H., B. JAMES, G. F. BRYANT, and K. J. ÅSTRÖM (1997): "Multivariable controller tuning—some preliminary results." In *Symposium on Quantitative Feedback Theory and Other Frequency-Based Methods and Applications*. Glasgow, Scotland.

An introductory investigation of problems when scalar tuning methods are extended to multivariable systems is given in

JOHANSSON, K. H. (1993): "Difficulties when Applying SISO Relay Design Methods to a MIMO system" Report ISRN LUTFD2/TFRT-7506--SE. Department of Automatic Control, Lund Institute of Technology, Lund, Sweden.

Other publications

The introduction of the thesis gives background material and a brief summary of the contributions of the five papers. Some ideas and examples in the introduction have appeared earlier. To be specific, the model for the deaeration process is derived in

JOHANSSON, K. H. (1997): "Modeling and control of a deaeration process." Unpublished manuscript.

and some of the discussions on practical aspects of multivariable control were presented as

JOHANSSON, K. H., T. HÄGGLUND, and K. J. ÅSTRÖM (1994): "An automatic start-up procedure for multivariable control systems." In *Reglermötet '94*. Västerås, Sweden.

These aspects were further developed in

JOHANSSON, K. H. (1994): "An automatic start-up procedure for multivariable control systems." Report ISRN LUTFD2/TFRT-7526--SE. Department of Automatic Control, Lund Institute of Technology, Lund, Sweden.

Preface

where also a list with models of real multivariable systems is given, for example, the heavy oil fractionator presented in the thesis introduction. The introduction also refers to

JOHANSSON, K. H. and A. RANTZER (1997): “A convergence proof for relay feedback systems.” Report ISRN LUTFD2/TFRT--7555--SE. Department of Automatic Control, Lund Institute of Technology, Lund, Sweden.

in connection to a discussion on globally attractive limit cycles in relay feedback systems.

A remark on notation

The thesis consists of five separated papers. The notation in the thesis is therefore *not* consistent, but is introduced in each paper. Most of it follows standard notation in control engineering textbooks.

Acknowledgments

It is a great pleasure to thank those who have given me the opportunity, support, and time to write this doctoral thesis.

My interest in relay feedback started on my very first day at the control department in Lund, when Karl Johan Åström presented some open problems connected to automatic tuning. Since then he has always been a great source of inspiration for me. It has been a true honor to work together with him. I am particularly grateful for the drive with which he has supported many ideas. Karl Johan has initiated valuable contacts, both industrial and academic. One such contact gave rise to a project with ABB Industrial Systems AB, which eventually led me to the investigation of the practical aspects of multivariable control systems. Another contact led to a cooperation with the control group at the Imperial College.

It has been very rewarding and stimulating to work together with Anders Rantzer. I have benefited from our many discussions, enjoyed his optimism, and taken advantage of all help he has provided me. I am particularly thankful to him for sharing some of his mathematical intuition and skill. Anders has also helped me limit my investigations, which in large part has ensured that the thesis is available in print today.

The main part of the thesis consists of five papers. I am certainly indebted to the coauthors of these. They are stated on the first page of each paper and their affiliations are given at the end of the thesis. The coauthors are Karl Johan Åström, Andrey Barabanov, Greyham Bryant, Ben James, Anders Rantzer, and José Luís Rocha Nunes.

Karl Johan Åström and Anders Rantzer have made numerous suggestions and corrections to various versions of the thesis manuscript. I am also particularly grateful to Bo Bernhardsson, who has read and commented several parts. Per Hagander gave many valuable remarks on Paper 3. Bernt Nilsson helped me derive the deaeration process model in Example 2 of the introduction. The part on automatic tuning is influenced from discussions with Tore Hägglund.

I would like to take the opportunity to thank all my colleagues at the Department of Automatic Control in Lund for having provided me with such a creative and friendly atmosphere to work in. I am profoundly grateful to Bo Bernhardsson, Ulf Jönsson, and Henrik Olsson for many stimulating discussions throughout the years. I have also enjoyed work and spare time together with many other colleagues, in particular, Mats Åkesson, Lennart Andersson, Mikael Johansson, Jörgen Malmberg, Johan Nilsson, Lars Malcolm Pedersen, Anders Robertsson, and Anders Wallén.

Special thanks to Leif Andersson for providing excellent computer and typesetting facilities at the department. Eva Dagnegård has kindly organized the printing of the thesis and she has also taken the picture of the quadruple-tank laboratory process on page 3. The process was built by Rolf Braun. I also want to express my gratitude to Eva Schildt, who has helped me with many practical arrangements.

I would finally like to thank all my friends and my beloved family, who have given me many great moments far away from relays and control systems. In particular, the care from my mother and the optimism from my father are important ingredients in my life. Most of all I would like to thank my little princess Liselott, to whom I dedicate the thesis, for her support and love.

This work has been financially supported by the Swedish Research Council for Engineering Science (TFR) under contract 95-759. I am also grateful for several travel grants from the Royal Physiographic Society and the Royal Swedish Academy of Sciences (KVA). The Swedish Council for Planning and Coordination of Research (FRN) supported a research stay during the summer 1993 at the International Institute of Applied System Analysis in Austria. A second stay, the year after, was supported by the institute itself. The financial aid from Scania AB is also thankfully acknowledged.

K. H. J.

Preface

Introduction

Oscillations are apparent in everyday life: one's mood goes up and down; the sun rises and sets; interest rates increase and decrease etc. Many technical systems are also oscillating. Some of them are even based on a swinging component, such as watches, radio transmitters, and gyroscopes. Two key ingredients in many oscillating systems are feedback and nonlinearity. This thesis treats a special type of nonlinear feedback systems that we call *relay feedback systems*. It will be shown that such a system may generate a variety of oscillations. Relay feedback systems have several engineering applications including a recent one in the design of controllers in process industry. This is the link to the second topic of the thesis: multivariable control systems. Although in many control applications only a single variable is considered, there are several systems for which more than one variable must be controlled simultaneously; examples include flight control (where altitude, forward speed, and pitch angle are typical controlled variables) and the deaeration process described later in Example 2 (where a liquid level together with a temperature and a pressure are controlled). Both practical and theoretical aspects of multivariable control systems will be discussed in the thesis. In particular, the method for tuning single-input single-output (SISO) controllers based on relay feedback will be generalized to multi-input multi-output (MIMO) controllers and a new result on performance limitations in decentralized control systems will be proved.

The intention of this introduction is to give some background and to motivate the work presented in the following five papers. The introduction is organized as follows. Multivariable systems are discussed in Section 1. Three real systems are introduced and some characteristics of linear multivariable systems and design methods are briefly mentioned. Background to performance limitation analysis is given in Section 2. Relay feedback systems are introduced in Section 3 and motivation for their study is presented. Further motivation is given in Section 4, where automatic tuning based on relay feedback experiments is discussed.

1. Multivariable Systems

Undesirable interaction between variables is a common problem in industrial process control. Multivariable controllers are in practice more difficult to handle than scalar, even though theoretically MIMO and SISO systems have many similar properties. Research on multivariable control has focused on mathematical concepts, rather than on dealing with practical issues. The consequence is that multivariable control design methods developed during the last twenty years have had a remarkable small influence on real applications. A possible exception is the growing application of predictive control in process industry [Brisk, 1993]. However, control algorithms in such a high-tech application as the Eurofighter 2000 is designed with methods developed decades ago [Fielding, 1997].

In this section we introduce some basic concepts related to control of multivariable linear time-invariant systems. The presentation, which is focused on issues related to Papers 3–5, is not exhaustive. The reader is referred to [Rosenbrock, 1970; Kailath, 1980; Rugh, 1993] for an introduction to linear systems and to [Rosenbrock, 1974; Maciejowski, 1989; Boyd and Barratt, 1991; Zhou *et al.*, 1996] for control design methods for such systems.

The outline of the section is as follows. Three multivariable systems to be used in several examples are first described. Characteristics, such as multivariable zeros for linear time-invariant systems, are then introduced. Finally, some existing design techniques are briefly mentioned.

Examples

It is essential to keep applications in mind even if theoretical aspects of control are discussed. In this section three models of real multivariable systems are discussed. The first model is a quadruple-tank process. This is a new laboratory process which was developed to demonstrate some ideas in the thesis. It is also suitable for the illustration of many other multivariable phenomena. It is further discussed in Paper 4 and [Johansson and Nunes, 1997]. The second system is a deaeration process. This process is part of a filling line manufactured by Tetra Pak Processing Systems AB in Lund. The model is derived in [Johansson, 1997]. A heavy oil fractionator is also described. This model has been provided as a multivariable benchmark problem to the control community by one of the Shell subsidiaries [Prett *et al.*, 1990]. More examples of multivariable control problems are given in [Singh, 1987; Siamantas, 1994; Johansson, 1994].

EXAMPLE 1—QUADRUPLE-TANK PROCESS

A picture of the quadruple-tank process is shown in Figure 1. The goal is to control the level in the bottom two tanks with the help of two pumps.



Figure 1. The quadruple-tank laboratory process. The water levels in the lower two tanks are controlled with the help of two pumps.

The process inputs are u_1 and u_2 (input voltages to the pumps) and the outputs are y_1 and y_2 (voltages from level measurement devices). There are two valves that distribute the flows to the tanks. They are set prior to an experiment. The valves affect the zeros of the system drastically. In this way it is possible to make the control problem easy or difficult. The positions of the valves can be expressed with two parameters $\gamma_1, \gamma_2 \in [0, 1]$. With $\gamma_1 = 0$ the flow goes only to the upper right tank and with $\gamma_1 = 1$ it goes only to the lower left tank. The parameter γ_2 is defined similarly. From mass balances and Bernoulli's law we get four nonlinear differential equations. Linearization of these gives the transfer matrix

$$G(s) = \begin{pmatrix} \frac{\gamma_1 c_{11}}{1 + sT_1} & \frac{(1 - \gamma_2)c_{12}}{(1 + sT_3)(1 + sT_1)} \\ \frac{(1 - \gamma_1)c_{21}}{(1 + sT_4)(1 + sT_2)} & \frac{\gamma_2 c_{22}}{1 + sT_2} \end{pmatrix},$$

where c_{ij} and T_i are positive constants that depend on the cross-section areas of the tanks and the outlets, the amplification in the actuators and measurement devices, and the operating point. In Paper 4 two particular setups are studied, namely $(\gamma_1, \gamma_2) = (0.70, 0.60)$ and $(\gamma_1, \gamma_2) =$

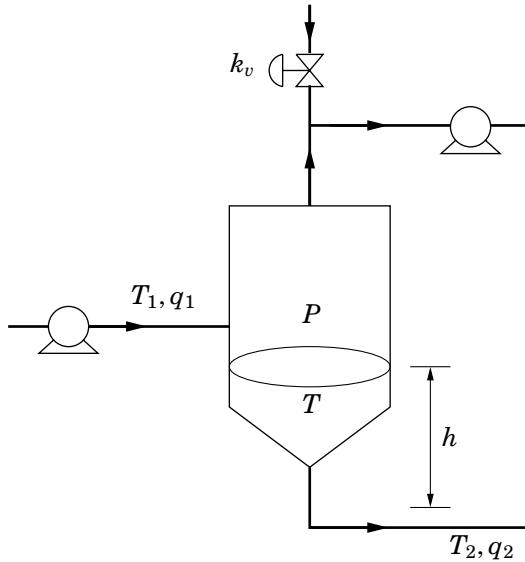

Figure 2. An industrial deaeration process for juice packaging. The controlled variables are tank pressure P , juice temperature T , and juice level h .

(0.43, 0.34). These correspond to

$$G_-(s) = \begin{pmatrix} \frac{2.6}{1 + 62s} & \frac{1.5}{(1 + 23s)(1 + 62s)} \\ \frac{1.4}{(1 + 30s)(1 + 90s)} & \frac{2.8}{1 + 90s} \end{pmatrix}$$

and

$$G_+(s) = \begin{pmatrix} \frac{1.5}{1 + 63s} & \frac{2.5}{(1 + 39s)(1 + 63s)} \\ \frac{2.5}{(1 + 56s)(1 + 91s)} & \frac{1.6}{1 + 91s} \end{pmatrix},$$

respectively. It is shown in Paper 4 that G_- has no finite right half-plane zeros but G_+ has one zero at 0.013. \square

The second example is an industrial multivariable process derived in [Johansson, 1997].

EXAMPLE 2—DEAERATION PROCESS

Figure 2 shows a deaeration process which is part of a production line for juice packaging. This process removes oxygen from the juice to improve the quality preservation. The juice, pre-heated to about 55 °C, enters the

vacuum chamber from the left. Part of the oxygen content of the juice is evaporated in the chamber and is removed by the top pump. The juice leaves the chamber through the bottom pipe and is cooled in a heat-exchanger and packaged. Main variables are

- the juice level h ;
- the tank pressure P ;
- the tank temperature T , the inlet temperature T_1 , and the outlet temperature T_2 ; and
- the inlet flow q_1 and the outlet flow q_2 .

The controlled variables are h , P , and T . The normal operating point (h^0, P^0, T^0) is determined such that the evaporation is sufficiently efficient. The system is controlled by manipulating the valve k_v (see Figure 2) and the flow q_1 .

More variables and parameters to describe a physical model of the system are needed. Let $A(h)$ be the cross-section area of the tank, $V(h)$ the liquid volume in the tank, and $V_g(h)$ the gas volume in the tank. Furthermore, M is the molecular weight of the gas, R is the ideal gas constant, and P_{air} the air pressure. The liquid density is denoted ρ , its heat capacity C_p , and its vapor enthalpy ΔH_{vap} . Finally, let W_{evap} be the mass flow of evaporated liquid and W_{pump} the mass flow through the upper pump in Figure 2.

The temperature equals the vapor temperature at normal operation (evaporation), so $T = T_{\text{vap}}(P)$. The system is described by the differential–algebraic equation

$$\begin{aligned} A(h) \frac{dh}{dt} &= q_1 - q_2, \\ \tau_P(h, T, k_v) \frac{dP}{dt} &= -P + P_{\text{air}} - \frac{W_{\text{pump}}}{k_v} + \frac{W_{\text{evap}}}{k_v} \\ &\quad + \frac{PA(h)M}{k_v RT} \frac{dh}{dt} + \frac{PV_g(h)M}{k_v RT^2} \frac{dT}{dt}, \\ \tau_T(h, q_2) \frac{dT}{dt} &= -T + \frac{q_1}{q_2} T_1 - \frac{A(h)T}{q_2} \frac{dh}{dt} - \frac{\Delta H_{\text{vap}}}{q_2 \rho C_p} W_{\text{evap}}, \\ T &= T_{\text{vap}}(P). \end{aligned}$$

Note that the dynamics are of second order, because of the algebraic relation between T and P . The left-hand side dT/dt is explicitly given by dP/dt , so the variable W_{evap} is indirectly given by the third equation. The variables τ_P and τ_T are given as

$$\tau_P(h, T, k_v) = \frac{V_g(h)M}{k_v RT}, \quad \tau_T(h, q_2) = \frac{V(h)}{q_2}.$$

If the liquid is not evaporating the dynamics are of third order:

$$\begin{aligned}
 A(h) \frac{dh}{dt} &= q_1 - q_2, \\
 \tau_P(h, T, k_v) \frac{dP}{dt} &= -P + P_{\text{air}} - \frac{W_{\text{pump}}}{k_v} \\
 &\quad + \frac{PA(h)M}{k_v RT} \frac{dh}{dt} + \frac{PV_g(h)M}{k_v RT^2} \frac{dT}{dt}, \\
 \tau_T(h, q_2) \frac{dT}{dt} &= -T + \frac{q_1}{q_2} T_1 - \frac{A(h)T}{q_2} \frac{dh}{dt}.
 \end{aligned}$$

Linearizing the equation at an operation point under normal conditions gives two first-order dynamic equations. They describe level dynamics and pressure dynamics and are decoupled. The level dynamics are given by an integrator and the pressure dynamics by a first-order system with time constant $\tau_P(h^0, T^0, k_v^0)$. The system thus has the interesting property that its order may change during the operation. \square

The third example is an industrial multivariable process from [Prett *et al.*, 1990].

EXAMPLE 3—HEAVY OIL FRACTIONATOR

A diagram of a heavy oil fractionator is shown in Figure 3. The plant has three product draws and three side circulating loops. The system has five inputs and seven outputs. The inputs are the control signals top draw u_1 , side draw u_2 , and bottoms reflux u_3 , and the disturbances intermediate reflux u_4 and upper reflux u_5 . The outputs are the compositions of the top draw product and side draw product y_1 and y_2 , respectively, the top temperature y_3 , the upper reflux temperature y_4 , the side draw temperature y_5 , the intermediate reflux temperature y_6 , and the bottoms reflux temperature y_7 .

The transfer matrix G of the model has elements

$$G_{ij}(s) = \frac{K_{ij}}{1 + sT_{ij}} e^{-sL_{ij}}, \quad i = 1, \dots, 7, \quad j = 1, \dots, 5,$$

where

$$K = \begin{pmatrix} 4.05 & 1.77 & 5.88 & 1.20 & 1.44 \\ 5.39 & 5.72 & 6.90 & 1.52 & 1.83 \\ 3.66 & 1.65 & 5.53 & 1.16 & 1.27 \\ 5.92 & 2.54 & 8.10 & 1.73 & 1.79 \\ 4.13 & 2.38 & 6.23 & 1.31 & 1.26 \\ 4.06 & 4.18 & 6.53 & 1.19 & 1.17 \\ 4.38 & 4.42 & 7.20 & 1.14 & 1.26 \end{pmatrix}$$

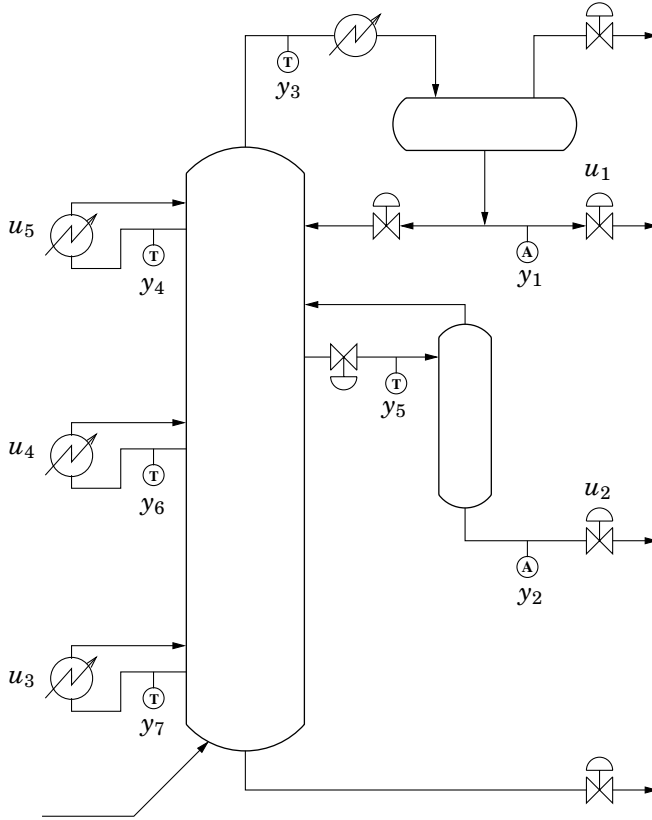

Figure 3. The Shell heavy oil fractionator is a benchmark control problem with five inputs and seven outputs.

and

$$L = \begin{pmatrix} 27 & 28 & 27 & 27 & 27 \\ 18 & 14 & 15 & 15 & 15 \\ 2 & 20 & 2 & 0 & 0 \\ 11 & 12 & 2 & 0 & 0 \\ 5 & 7 & 2 & 0 & 0 \\ 8 & 4 & 1 & 0 & 0 \\ 20 & 22 & 0 & 0 & 0 \end{pmatrix}, \quad T = \begin{pmatrix} 50 & 60 & 50 & 45 & 40 \\ 50 & 60 & 40 & 25 & 20 \\ 9 & 30 & 40 & 11 & 6 \\ 12 & 27 & 20 & 5 & 19 \\ 8 & 19 & 10 & 2 & 22 \\ 13 & 33 & 9 & 19 & 24 \\ 33 & 44 & 19 & 27 & 32 \end{pmatrix}.$$

The time constants and the time delays are given in minutes. \square

Characteristics of linear multivariable systems

The frequency response captures many properties of a scalar linear system, such as gain, phase, and robustness. The frequency responses of the eigenvalues of the transfer matrix may seem to be a natural generalization for a multivariable system. However, the eigenvalues do not say much about signal propagation and they can be extremely sensitive to small perturbations in the matrix elements. The widely accepted generalization of SISO gain is instead obtained through the *singular values*. The singular values σ_k , $k = 1, \dots, m$, of an $m \times m$ matrix M are the nonnegative square roots of the eigenvalues of M^*M , where the asterisk denotes conjugate transpose. Each matrix has a singular value decomposition

$$M = U\Sigma V^*,$$

where $\Sigma = \text{diag}\{\sigma_1, \dots, \sigma_m\}$, $\sigma_{\max} = \sigma_1 \geq \dots \geq \sigma_m = \sigma_{\min}$, and U and V are unitary matrices consisting of the *singular vectors*. The maximal “amplification” of M is then given by the largest singular value

$$\sigma_{\max}(M) = \sup_{x \neq 0} \frac{\|Mx\|}{\|x\|},$$

where $\|\cdot\|$ denotes the Euclidean vector norm. See [Golub and van Loan, 1989; Horn and Johnson, 1996] for further properties of singular values.

The singular values of a transfer matrix $G(s)$ captures signal amplification and robustness properties of the multivariable system [Doyle, 1992]. Note, however, that there is no natural phase function related to the singular values. The “gain” or norm of $G(s)$ is given by the largest singular value

$$\|G(s)\| := \sigma_{\max}(G(s))$$

and for stable systems the frequency peak of this norm is the H_∞ norm

$$\|G\|_\infty := \sup_{\text{Re } s \geq 0} \|G(s)\| = \sup_{\omega \in (0, \infty)} \|G(i\omega)\|.$$

If $\sigma_{\max}(G(s))/\sigma_{\min}(G(s))$ is large, then G is sensitive to perturbations in directions associated with the corresponding singular vectors for that complex frequency s . The difficulty in a linear multivariable control design problem is in some sense determined by how large this fraction is. This has been explored in the process control literature [Moore, 1986; Morari and Zafiriou, 1989] and is illustrated in the following example.

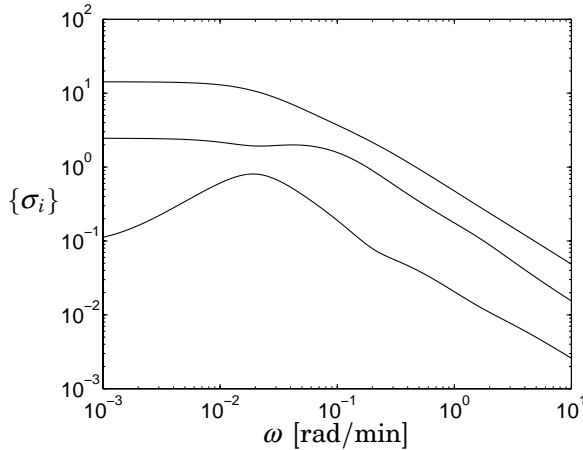

Figure 4. Singular values of the subsystem G_3 as a function of frequency for the heavy oil fractionator.

EXAMPLE 4—HEAVY OIL FRACTIONATOR (CONT'D)

Consider a subsystem of the model of the heavy oil fractionator given in Example 3. The subsystem is denoted G_3 and consists of the inputs u_1 , u_2 , and u_3 and the outputs y_1 , y_2 , and y_3 . Figure 4 shows the singular values of $G_3(i\omega)$. Note the large difference between $\sigma_{\max}(i\omega)$ and $\sigma_{\min}(i\omega)$ for small ω . This indicates that the system is sensitive to certain low-frequency disturbances. These disturbances are connected to directions related to the singular vectors. \square

The singular values may give conservative results of performance measures, because they relate to the worst case. In many applications disturbances in certain directions are more likely than others. This can be taken into account by a transfer matrix weight, see Chapter 3 in [Maciejowski, 1989].

We assume in the following that G is square (m inputs and m outputs) and of full normal rank [Zhou *et al.*, 1996]. For some distinct points $s \in \mathbf{C}$, the transfer matrix G might lose rank. These points are called transmission zeros and we take them as definition of multivariable zeros [Kailath, 1980; Rugh, 1993].

DEFINITION 1—ZERO

Let (A, B, C, D) be a minimal state-space realization of G . A point $z \in \mathbf{C}$ is called a zero of G if there exist complex vectors $x, \psi \in \mathbf{C}^n$ with $\psi^* \psi = 1$

such that

$$\begin{pmatrix} x^* & \psi^* \end{pmatrix} \begin{pmatrix} zI - A & -B \\ -C & -D \end{pmatrix} = 0.$$

□

In the following we suppose that the set of poles and the set of zeros are disjoint and that there is only unit rank loss of $G(s)$ at each zero.

The vector ψ is called the output zero direction and from Definition 1 it follows that $\psi^*G(z) = 0$. We notice that ψ is the last column of the singular vector matrix U from the singular value decomposition of $G(z)$. Input zero directions can be defined similarly. Zeros in the closed right half-plane (*RHP zeros*) are particularly bad for the system, as we will see in Section 2. These zeros are also called nonminimum phase zeros (which is actually an abuse of language, because there is no obvious phase function related to a transfer matrix).

Illustration of zeros in SISO and MIMO systems are often done through the following two examples from [Rosenbrock, 1970] and [Rosenbrock, 1969], respectively. The elements of the transfer matrix

$$G_a(s) = \begin{pmatrix} \frac{1}{s+1} & \frac{2}{s+3} \\ \frac{1}{s+1} & \frac{1}{s+1} \end{pmatrix}$$

have no SISO RHP zeros, whereas G_a has a MIMO zero at $+1$. All elements of

$$G_b(s) = \begin{pmatrix} \frac{1-s}{(s+1)^2} & \frac{2-s}{(s+1)^2} \\ \frac{1-3s}{3(s+1)^2} & \frac{1-s}{(s+1)^2} \end{pmatrix}$$

have RHP zeros, although G_b is minimum phase. The well-known, but fundamental, conclusion is that there is no immediate relation between zeros of a transfer matrix and its submatrices.

Multivariable control design

There exists a variety of multivariable control design methods. They can roughly be divided into two categories: (1) those developed from a practical need of extending a single-loop control method to deal with interaction and (2) those being a theoretical extension of a scalar method that “automatically” introduce attenuation of interactions. In the first category we have for example decoupling [Ogunnaike and Ray, 1994], various Nyquist array methods [Rosenbrock, 1974; Maciejowski, 1989], sequential design

methods [Mayne, 1979; Bryant and Yeung, 1996], dynamic matrix control [Cutler and Ramaker, 1980], and QFT [Horowitz, 1979]. Examples of methods in the second category are LQG [Anderson and Moore, 1989], H_∞ and μ methods [Zhou *et al.*, 1996], and other optimization methods [Boyd and Barratt, 1991]. Internal model control [Morari and Zafriou, 1989] is probably the most commonly used multivariable control design method in process industry. The method is incorporated in several commercial systems. Internal model control was developed from dynamic matrix control and many of its properties have been theoretically analyzed.

No method is supreme for all applications. In general, however, one can claim that the design methods in the first category are better to deal with such practical constraints as pre-specified control structures, start-up procedures, and plant integrity. The methods in the second category are better understood theoretically.

Even if it is easy to find industrial plants where cross-coupling is apparent, the extensive effort of developing multivariable design methods have had remarkably little effect on real control systems. Intuitively, it seems obvious that a system should be easier to control if more manipulative and measured variables are available. It is, however, not trivial to decide how to use this extra freedom. Many practical problems remain unsolved. One such problem is initialization of multivariable controllers [Johansson *et al.*, 1994; Johansson, 1994].

Industrial multivariable control systems have often evolved from many years of experience from a particular application. We illustrate this by briefly describing the control system for the deaeration process.

EXAMPLE 5—DEAERATION PROCESS (CONT'D)

The control system for the industrial deaeration process in Example 2 has two loops: one level control loop and one pressure–temperature control loop. The level is controlled by a standard PI controller. The pressure and temperature form a cascade control loop with the pressure in the inner loop and the temperature in the outer. This configuration, together with some special arrangements, secures the correct temperature at normal operation. If the evaporation stops due to a disturbance, the system will return to normal operation. The control structure is the result of many modifications based on years of practical experience [Skoglund, 1996]. \square

2. Performance Limitations

System engineers are faced with the problem of designing systems that fulfill certain specifications. In doing this, it seems natural to first check

if a solution exists. The foundation of communication theory is based on Shannon's channel capacity results [Shannon, 1948]. The channel capacity sets an upper bound on achievable performance in a communication link and, for example, tells how much a system can be improved. In control engineering fundamental limitations on closed-loop systems have only recently been investigated, although the subject was discussed already in the classical textbooks [Bode, 1945; Horowitz, 1963]. Process design and control design are nowadays often treated simultaneously [Isermann, 1995; Skogestad and Postlethwaite, 1996; Goodwin, 1997]. This has resulted in an increased interest in investigating performance limitations. Recent extensions to the work by Bode and Horowitz are collected in [Freudenberg and Looze, 1988; Seron *et al.*, 1997].

Results on limitations in SISO and MIMO systems are first recalled in this section. These then lead to the result in Paper 3 on achievable performance in systems with a diagonal controller.

Limitations in SISO systems

Most results on performance limitations of linear feedback systems are derived in terms of achievable sensitivity function. For example, consider a stable transfer function G with pole excess two or higher. The sensitivity function for the closed-loop system $S = (1 + GC)^{-1}$ then satisfies Bode's integral

$$\int_0^{\infty} \log |S(i\omega)| d\omega = 0, \quad (1)$$

see [Bode, 1945]. If $|S(i\omega)|$ is less than one for some frequencies, it must necessarily be greater than one for other frequencies. In the presence of bandwidth limitations the integral thus imposes design trade-offs between different frequency bands. These were discussed in the 1989 Bode lecture [Stein, 1990]. The formula (1) together with complex analysis gives several similar results. Time-delay systems are studied in [Freudenberg and Looze, 1987; Gómez and Goodwin, 1997] and nonlinear systems in [Shamma, 1991; Seron and Goodwin, 1996]. Other fundamental performance results include the derivation of "cheap control" in [Qui and Davison, 1993; Seron *et al.*, 1997b]. Performance limitations due to phase margin specifications are derived in [Åström, 1996] and are applied to multi-loop design in [Johansson, 1996].

We present an interesting result, which is proved in [Freudenberg and Looze, 1985], that has been referred to as the waterbed effect [Doyle *et al.*, 1992]. It shows that if a design method forces the sensitivity to be low in one frequency region, it necessarily has to be large in another if the open-loop system has RHP zeros. Consider a process represented by a transfer

function G and controller given by a transfer function C . Assume that the loop-gain $L := GC$ has RHP zeros in $\{z_i\}_{i=1}^{n_z}$ and RHP poles in $\{p_i\}_{i=1}^{n_p}$ and that it can be factored as

$$L(s) = \tilde{L}(s)B_p^{-1}(s)B_z(s), \quad (2)$$

where

$$B_z(s) := \prod_{i=1}^{n_z} \frac{z_i - s}{z_i^* + s}, \quad B_p(s) := \prod_{i=1}^{n_p} \frac{p_i - s}{p_i^* + s},$$

and the transfer function $\tilde{L}(s)$ is proper and has no RHP zeros or poles. Introduce for a zero z the function

$$\Theta_z(\omega_b) := \int_{-\omega_b}^{\omega_b} \operatorname{Re} \frac{1}{z - i\omega} d\omega.$$

Then we have the following result from [Freudenberg and Looze, 1985].

PROPOSITION 1

Consider an open-loop system L , suppose it gives a stable closed-loop system and that L can be factored as (2). Suppose also that the sensitivity function $S = (1 + GC)^{-1} = (1 + L)^{-1}$ satisfies the design constraint

$$|S(i\omega)| \leq \alpha < 1$$

for all $\omega \in [0, \omega_b]$. Then, for each RHP zero z of L , we have

$$\|S\|_\infty \geq \left(\frac{1}{\alpha}\right)^{\Theta_z(\omega_b)/(\pi - \Theta_z(\omega_b))} |B_p^{-1}(z)|^{\pi/(\pi - \Theta_z(\omega_b))}. \quad (3)$$

□

Note that both the bases of (3) are greater than one and their exponents are positive. Hence, $\|S\|_\infty > 1$. Furthermore, as α and $|B_p(z)|$ decrease, the right-hand side of (3) increases. In particular, for a system with an open-loop RHP pole p close to a RHP zero z , the factor $|B_p^{-1}(z)|$ in (3) is large. As p gets closer to z , the system will have a higher and higher peak in the sensitivity function.

We illustrate Proposition 1 with an example.

EXAMPLE 6

Consider an open-loop system with a RHP zero at $z = 1$ and no RHP poles. Then, (3) becomes

$$\|S\|_\infty \geq \left(\frac{1}{\alpha}\right)^{\Theta_z(\omega_b)/(\pi - \Theta_z(\omega_b))} \quad (4)$$

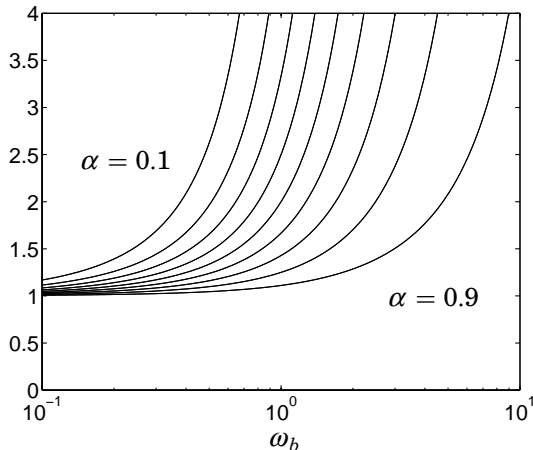

Figure 5. Estimated lower bound of $\|S\|_\infty$ as a function of the system bandwidth ω_b . The design constraint is $|S(i\omega)| \leq \alpha < 1$ for $\omega \in [0, \omega_b]$.

with

$$\Theta(\omega_b) = -\arg \left\{ \frac{1 - i\omega_b}{1 + i\omega_b} \right\}.$$

Figure 5 shows the right-hand side of (4) as a function of the bandwidth ω_b for $\alpha \in [0.1, 0.9]$ in step of 0.1. We see that because of the zero at one, the bandwidth must be less than one if the sensitivity is made small in $[0, \omega_b]$. For many practical systems, a reasonable rule of thumb is $\|S\|_\infty \approx 2$ or less [Åström and Hägglund, 1995]. \square

Note that in results such as Proposition 1 the imaginary axis has a supreme position: a zero has a dramatically different influence depending on if it is to the left or to the right of the imaginary axis. A similar sensitivity to the zero location is the consequence of a result in [Middleton, 1991]. Middleton's result is interpreted in the complementary sensitivity function $T = 1 - S$ and says that if $T(0) = 1$ and the closed-loop system is stable, then

$$\frac{2}{\pi} \int_0^\infty \log |T(i\omega)| \frac{d\omega}{\omega^2} = \lim_{s \rightarrow 0} \frac{dT}{ds} + 2 \sum_{i=1}^{n_z} \frac{1}{z_i}, \quad (5)$$

where z_i are the RHP zeros. We see again that RHP zeros close to the origin give poor closed-loop performance. For simplicity, assume that the open-loop system has a double integrator, so that $\lim_{s \rightarrow 0} dT/ds = 0$, and that L has only the two complex conjugated RHP zeros $z_1 = x + iy$ and

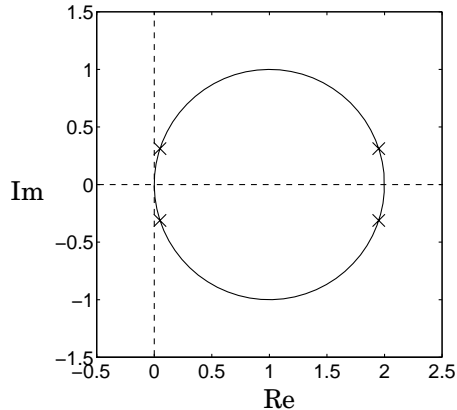

Figure 6. Complex RHP zeros on the circle give the same design limitations according to (5).

$z_2 = x - iy$. It follows from (5) that the limitations imposed by the zeros are proportional to $1/z_1 + 1/z_2$. Hence, all zeros on the circle defined by

$$\frac{1}{z_1} + \frac{1}{z_2} = \frac{1}{r}$$

or

$$(x - r)^2 + y^2 = r^2$$

are in this sense equally bad. This is illustrated in Figure 6 for $r = 1$, where two pairs of zeros affecting the closed-loop performance similarly in the sense of (5) are shown. Even if these two pairs are located far from each other, they affect the feedback design in the same way. The reason for this result is that only the frequency response of the system is considered. A physical illustration is given in Example 9 in the end of next section.

Limitations in MIMO systems

Some of the results for limitations in scalar feedback systems have been generalized to multivariable systems. One of the first formal result was derived in [Zames, 1981].

It is important to capture the directions associated with each pole and zero for a MIMO system. If a SISO system has a RHP zero, its effect can be spread over a frequency band. For a MIMO system there is also the possibility of distributing the effect of the zero over different inputs and outputs. This is illustrated in the following. First recall the definition of

a multivariable zero given by Definition 1 in Section 1. A zero z and its output direction ψ satisfy $\psi^*G(z) = 0$.

An important question is to determine the properties of the plant that limit the achievable performance. For stable multivariable linear systems under centralized control it was formally shown by Zames in the classical paper [Zames, 1981] that there are no limits on the sensitivity function for a system that has no RHP zeros.

PROPOSITION 2

Consider a stable transfer matrix G with no RHP zeros and a strictly proper stable transfer function W with no RHP zeros. For every $\varepsilon > 0$ there exists a strictly proper stabilizing and stable controller C such that

$$\|W(I + GC)^{-1}\|_\infty < \varepsilon.$$

□

A slight variation of this result is proved as Lemma 2 in Paper 3. A generalization to unstable open-loop systems is given in [Francis, 1987]. The feedback deterioration related to RHP zeros in multivariable systems was also derived in [Zames, 1981].

PROPOSITION 3

Consider a stable transfer matrix G with RHP zeros in $z_i, i = 1, \dots, \ell$, and a proper stable transfer function W with no RHP zeros. Then for every proper stabilizing controller C

$$\|W(I + GC)^{-1}\|_\infty \geq \max_{i \in \{1, \dots, \ell\}} |W(z_i)|.$$

□

We use the laboratory tank process in Section 1 as illustration.

EXAMPLE 7—QUADRUPLE-TANK PROCESS (CONT'D)

Consider the two linear models G_- and G_+ for the quadruple-tank process given in Example 1. It is shown in Paper 4 that G_- has multivariable zeros in -0.060 and -0.018 and that G_+ has zeros in -0.057 and 0.013 .

It follows from Proposition 2 that there exists a stabilizing feedback controller

$$C = \begin{pmatrix} C_{11} & C_{12} \\ C_{21} & C_{22} \end{pmatrix},$$

such that the weighted sensitivity $\|W(I + G_-C)^{-1}\|_\infty$ can be made arbitrarily small. Proposition 3, however, gives that this is not the case for G_+ .

Loop shaping is typically done in the H_∞ framework by letting W be the inverse of the desired frequency response for S and then finding a stabilizing controller such that $\|WS\|_\infty < 1$, see [Zhou *et al.*, 1996]. Introduce the weighting function

$$W(s) = \frac{b}{s + a}$$

with $a > 0$ and $b > 0$. It follows from Proposition 3 that

$$\|W(I + G_+C)^{-1}\|_\infty > |W(z)| = \frac{b}{z + a},$$

where z is the unstable zero. If it is required that the sensitivity to static disturbances should be less than 0.1 ($b/a = 10$), it follows that the constraint $a < z/9$ must be satisfied. Hence, the sensitivity must only be attenuated up to approximately a frequency one decade lower than z or up to 0.0014 rad/s. This happens to be the approximate bandwidth of the manually tuned system in Paper 4. \square

Next we present an extension of Proposition 1 to multivariable systems given in [Gómez and Goodwin, 1996]. Bounds are given on the elements of S .

PROPOSITION 4

Consider a transfer matrix G with a RHP zero at z and corresponding output zero direction ψ and let $k \in \{1, \dots, m\}$. If a stabilizing feedback is applied such that S satisfies the design constraints

$$|S_{ik}(i\omega)| \leq \alpha_{ik} < 1$$

for all $\omega \in [0, \omega_b]$ and $i = 1, \dots, m$ and $\psi_k \neq 0$, then

$$\|S_{kk}\|_\infty \geq \left(\frac{1}{\alpha_{kk} + \sum_{\substack{i=1 \\ i \neq k}}^n \alpha_{ik} |\psi_i / \psi_k|} \right)^{\Theta_z(\omega_b) / (\pi - \Theta_z(\omega_b))} - \sum_{\substack{i=1 \\ i \neq k}}^n \|S_{ik}\|_\infty |\psi_i / \psi_k|. \quad (6)$$

\square

Compare (4) and (6). The freedom given by the extra inputs and outputs admits a smaller lower bound in the latter case: the base of the first term in the right-hand side of (6) is smaller than $1/\alpha_{kk}$ and the second term reduces the bound even further. Note that this is not the case if the zero is associated with only one output, that is, $\psi_i = 0$ for all $i \neq k$. Bristol coined the term “pinned zeros” for such zeros [Morari and Zafiriou, 1989].

EXAMPLE 8—QUADRUPLE-TANK PROCESS (CONT'D)

Consider the nonminimum phase model G_+ for the quadruple-tank process. The zero direction for $z = 0.013$ is $\psi = (-0.63, 0.78)^T$. In the sense of Proposition 4, the zero has almost the same association with both outputs. \square

It is important to note that Proposition 4 only tells how a *lower bound* of $\|S_{kk}\|_\infty$ is related to the zero directions. It is not claimed that $\|S_{kk}\|_\infty$ is close to this bound. It is shown in [Seron *et al.*, 1997] that for a specific design the sensitivity is influenced by the zero directions in a similar way as the bound in (6).

The results on performance limitations do not give the full picture. As pointed out in previous section, the reason for this is that only the frequency response is evaluated. We illustrate this with an example.

EXAMPLE 9—QUADRUPLE-TANK PROCESS (CONT'D)

Consider again the quadruple-tank process in Example 1. The adjustment of two valves gives the two parameters $\gamma_1, \gamma_2 \in [0, 1]$ that define the tube flows. It is shown in Paper 4 that the linearized model of the system has a RHP zero if and only if $0 < \gamma_1 + \gamma_2 \leq 1$. If the valves are adjusted such that $\gamma_1 + \gamma_2$ is slightly less than one, the system has a RHP zero close to the origin and the previous results state that the system is difficult to control. However, a small change in one of the valves may result in $\gamma_1 + \gamma_2$ greater than one and theoretically no limitations on the achievable control performance. In practice, of course, the difficulty of controlling the quadruple-tank process does not change abruptly with a small variation in one of the valves. \square

Limitations with diagonal controller

There are few results on performance limitations for control systems with a special controller structure. This is surprising because bounds on achievable performance as derived previously are natural tools for investigating different control structures. If the achievable performance is lower for one structure than another, it is reasonable to also believe that the real system performs better with the latter control structure. It is not easy to find good control structures for decentralized control systems, but the result in Paper 3 is a step in this direction. First, however, a related result in [Zames and Bensoussan, 1983] is given.

Zames and Bensoussan noticed that if a transfer matrix G tends to diagonal at high frequencies, then it is possible to invert its dynamics arbitrarily well by a diagonal controller if G has no RHP zeros. The following definition is needed.

DEFINITION 2—ULTIMATELY DIAGONALLY DOMINANT

A transfer matrix G is called ultimately diagonally dominant if there exists a diagonal transfer matrix D with no RHP zeros and a constant $\alpha \in [0, 1)$ such that

$$\sup_{\substack{|s| \geq R \\ \operatorname{Re} s \geq 0}} \|G(s)D^{-1}(s) - I\| \rightarrow \alpha, \quad R \rightarrow \infty.$$

□

Corollary 1 in [Zames and Bensoussan, 1983] gives the following result.

PROPOSITION 5

Consider a strictly proper transfer matrix G with no RHP zeros and a proper stable transfer matrix W . Assume G is ultimately diagonally dominant with constant α and $\sigma_{\min}[G(s)] \geq \eta|s|^{-k}$, $|s| \geq R$, for some constants $\eta > 0$, $R > 0$, and an integer $k > 0$. Then, for every $\varepsilon > \|W(\infty)\|(1 - \alpha)^{-1}$ there exists a strictly proper stabilizing and stable diagonal controller $C = \operatorname{diag}\{C_1, \dots, C_m\}$ such that

$$\|W(I + GC)^{-1}\|_{\infty} < \varepsilon.$$

□

The assumptions in Proposition 5 are fulfilled for one of the setups for the quadruple-tank process.

EXAMPLE 10—QUADRUPLE-TANK PROCESS (CONT'D)

Consider the minimum-phase model G_- of the quadruple-tank process in Example 1. The transfer matrix G_- has no RHP zeros, it tends to diagonal at high frequencies, and $\sigma_{\min}[G_-(s)] > 0.01/|s|$ for sufficiently large $|s|$. It thus follows from Proposition 5 that the system can theoretically be controlled arbitrarily tight with diagonal feedback. □

Of course, all systems are not ultimately diagonally dominant.

EXAMPLE 11

The following model of an automotive gas turbine is given in [Winterbone *et al.*, 1973] and studied in Paper 3:

$$G(s) = \begin{pmatrix} \frac{130 \times 10^4 s + 33600 \times 10^4}{s^2 + 392s + 13900} & \frac{5.6s^2 + 246s + 744}{s^2 + 28.9s + 24.6} \\ \frac{904 \times 10^4 s + 28400 \times 10^4}{s^3 + 233s^2 + 8610s + 11900} & \frac{83.4s + 6300}{s^2 + 115s + 195} \end{pmatrix}.$$

Introduction

This transfer matrix is minimum phase but not ultimately diagonal. \square

The system in Example 11 is covered by a result that is proved in Paper 3. There the notion *sequentially minimum phase* is introduced for a partitioned transfer matrix

$$G = \begin{pmatrix} \boxed{G_1} & & & & \\ & \boxed{G_2} & & & \\ & & \ddots & & \\ & & & & \boxed{G_m} \end{pmatrix},$$

where

$$G_k := \begin{pmatrix} G_{11} & \dots & G_{1k} \\ \vdots & & \vdots \\ G_{k1} & \dots & G_{kk} \end{pmatrix}.$$

DEFINITION 3

A stable transfer function matrix G is *sequentially minimum phase* if G_1, \dots, G_m have full normal rank and no RHP zeros. \square

Let the first $k - 1$ elements of the last row of G_k be denoted

$$L_k := \begin{pmatrix} G_{k1} & \dots & G_{k,k-1} \end{pmatrix}.$$

Assume that G_k for $k \in \{1, \dots, m - 1\}$ has no RHP zeros and that W is a proper stable transfer function with no RHP zeros. Define the scalars $\phi_k(W) \in [0, \infty]$ as

$$\phi_k(W) := \|W^{-1}L_k G_{k-1}^{-1}\|_\infty$$

for $k = 2, \dots, m$. The following result is proved in Paper 3.

PROPOSITION 6

Consider a stable transfer matrix G and a strictly proper stable transfer function W with no RHP zeros. If G is sequentially minimum phase and $\phi_k(W)$ is bounded for $k = 2, \dots, m$, then for every $\varepsilon > 0$ there exists a strictly proper stabilizing and stable diagonal controller $C = \text{diag}\{C_1, \dots, C_m\}$ such that

$$\|W(I + GC)^{-1}\|_\infty < \varepsilon.$$

\square

EXAMPLE 12

Consider again the model in Example 11. The transfer matrix of the system is sequentially minimum phase, because $G_1 = G_{11}$ and $G_2 = G$ are minimum phase. Furthermore, $\phi_2(W) = \|W^{-1}G_{21}G_{11}^{-1}\|_\infty$ is bounded for all weighting functions of relative degree one. It is thus shown that the sensitivity function of the automotive gas turbine model in Example 11 can be reduced arbitrarily, in the sense of Proposition 6, with a stable diagonal feedback. \square

Proposition 6 also holds for block-diagonal controllers, where the blocks C_1, \dots, C_m have dimensions corresponding to the matrices G_1, \dots, G_m . The zeros of G_1, \dots, G_m for various block sizes can be used to choose input–output pairing and control structure. Calculating the zeros of submatrices of the plant for control structure design has been done to some extent. This is, for example, done in an aero-engine control design in Chapter 12 in [Skogestad and Postlethwaite, 1996]. There exist, however, few formal results supporting this strategy.

We do not claim that a system that satisfies the conditions in Proposition 6 should be, or even can be, controlled arbitrarily tight in practice. The result hints that if the conditions are fulfilled then the model probably does not capture all limitations imposed by the system. There are either other limitations, such as saturations, that should be considered or a more accurate model should be estimated. What is encompassed in the bounds is far from everything that is important for control design. Therefore, the performance limitations presented in this section are seldom the ultimate goal. This conservativeness is further discussed in the conclusions.

The assumptions of Proposition 6 can be slightly generalized to cover some more cases. Factor the weighting function as $W = W_1W_2$, for stable transfer functions W_1 and W_2 . Then,

$$\begin{aligned} L_k G_{k-1}^{-1} S_{k-1} R_k^T &= W^{-1} L_k G_{k-1}^{-1} W S_{k-1} R_k^T \\ &= W_1^{-1} L_k G_{k-1}^{-1} W S_{k-1} W_2^{-1} R_k^T, \end{aligned}$$

so that

$$\|L_k G_{k-1}^{-1} S_{k-1} R_k^T\|_\infty \leq \|W_1^{-1} L_k G_{k-1}^{-1}\|_\infty \cdot \|W S_{k-1}\|_\infty \|W_2^{-1} R_k\|_\infty.$$

This can be used to modify the proof of Proposition 6 (Theorem 1 in Paper 3). The assumption that $\phi_k(W) = \|W^{-1}L_k G_{k-1}^{-1}\|_\infty$ should be bounded can be replaced by the condition that both $\|W_1^{-1}L_k G_{k-1}^{-1}\|_\infty$ and $\|W_2^{-1}R_k\|_\infty$ should be bounded. The condition on the relative degrees of W , L_k , and G_{k-1} is thus distributed to W , L_k , G_{k-1} , and R_k . For 2×2 systems the

Introduction

assumption can be simplified, because for $k = 2$ we have

$$\|L_k G_{k-1}^{-1} S_{k-1} R_k^T\|_\infty = \left\| \frac{G_{21} G_{12} S_1}{G_{11}} \right\|_\infty \leq \left\| \frac{G_{21} G_{12}}{W G_{11}} \right\|_\infty \cdot \|W S_1\|_\infty.$$

We illustrate this with an example.

EXAMPLE 13

The sequentially minimum phase system

$$G(s) = \begin{pmatrix} \frac{1}{s+1} & \frac{1}{s+1} \\ \frac{1}{s+1} & \frac{-1}{s+1} \end{pmatrix}$$

with weighting function $W(s) = (s+1)^{-1}$ does not satisfy $\phi_2(W) < \infty$, but it does satisfy

$$\left\| \frac{G_{21} G_{12}}{W G_{11}} \right\|_\infty = 1 < \infty.$$

Using the constructive proof in Paper 3, we can derive a stabilizing controller $C = \text{diag}\{C_1, C_2\}$ that minimizes the weighted sensitivity function arbitrarily. One possible choice is

$$C_1(s) = \frac{s+1}{(1+\tau s)^2 - 1 + \delta}, \quad C_2(s) = -\frac{1}{2} \cdot \frac{s+1}{(1+\tau s)^2 - 1 + \delta},$$

where $\tau, \delta > 0$ are sufficiently small. For example, $\tau = \delta = 10^{-5}$ gives a closed-loop system with poles in p_i with $\text{Re } p_i < -1$ and

$$\|W(I + GC)^{-1}\|_\infty \approx 3.8 \times 10^{-5}.$$

□

Diagonal control structures were previously studied. Of course, it is also interesting to investigate performance limitations for control systems with other structures. For example, consider a stable 2×2 transfer matrix

$$G = \begin{pmatrix} G_{11} & G_{12} \\ G_{21} & G_{22} \end{pmatrix}$$

with no RHP zeros and a triangular controller

$$C = \begin{pmatrix} C_{11} & 0 \\ C_{21} & C_{22} \end{pmatrix}.$$

Then there exist stable transfer functions P_1 and P_2 such that $G_{11}P_1 + G_{12}P_2$ is stable and has no RHP zeros, compare Proposition 2 in Paper 5. The transfer matrix

$$\tilde{G} := \begin{pmatrix} G_{11} & G_{12} \\ G_{21} & G_{22} \end{pmatrix} \begin{pmatrix} P_1 & 0 \\ P_2 & 1 \end{pmatrix} = \begin{pmatrix} G_{11}P_1 + G_{12}P_2 & G_{12} \\ G_{21}P_1 + G_{22}P_2 & G_{22} \end{pmatrix}$$

is sequentially minimum phase, because $G_{11}P_1 + G_{12}P_2$, G , and

$$\begin{pmatrix} P_1 & 0 \\ P_2 & 1 \end{pmatrix}$$

have no RHP zeros. The weighted sensitivity function for \tilde{G} can therefore be arbitrarily minimized with a stabilizing and stable $D = \text{diag}\{D_1, D_2\}$ if

$$\left\| \frac{\tilde{G}_{21}\tilde{G}_{12}}{W\tilde{G}_{11}} \right\|_{\infty} = \left\| \frac{G_{12}(G_{21}P_1 + G_{22}P_2)}{W(G_{11}P_1 + G_{12}P_2)} \right\|_{\infty} < \infty.$$

This is the case if the transfer function between the norm bars is proper, because the numerator is stable and the denominator has no RHP zeros (provided that W is minimum phase). So if a condition on the relative degrees of the elements of G and W holds, then the stable and minimum phase transfer matrix G can be arbitrarily tightly controlled with a stable triangular controller

$$C = \begin{pmatrix} C_{11} & 0 \\ C_{21} & C_{22} \end{pmatrix} = \begin{pmatrix} P_1 & 0 \\ P_2 & 1 \end{pmatrix} \begin{pmatrix} D_1 & 0 \\ 0 & D_2 \end{pmatrix}.$$

For example, the relative degree condition holds if the relative degree of G_{12} is sufficiently large. Note that there is no requirement that any of the elements of G should be minimum phase.

3. Properties of Relay Feedback Systems

Oscillations appear in a variety of systems. An example from the financial world is oscillations in stock indices.

EXAMPLE 14—STOCK INDEX OSCILLATIONS

Stock indices often tend to oscillate. This was, for example, apparent the last hours prior to the stock market crash in October 19, 1987 [Antoniou and Garrett, 1993]. It seems reasonable to assume that the stock index influences the desire of a trader to buy or sell a certain stock. If she buys it

may effect what other traders do and therefore also the index itself. From a control engineer's point of view, the stock market can thus in a naive way be seen as a feedback system. If the "gain" in this system is sufficiently high (*i.e.*, the trader's reaction is large on information about fluctuations in the stock index), we may expect that the system starts to oscillate. Such oscillations appeared prior to the October crash. Supporting our feedback hypothesis, a U.S. presidential task force reported that by using program trading "few, aggressive, professional market participants can produce dramatic swings in market prices" [Arnfield, 1988]. A reason for them to induce oscillations would be that "volatility ... leads to arbitrage." Note the similarity between buy and sell limits in program trading and the switching conditions for a relay. \square

Oscillations and limit cycles are studied in many sciences; for example, oscillations in nonlinear dynamical systems is a large field in applied mathematics [Guckenheimer and Holmes, 1983]. The relay feedback system we will investigate is a particular type of nonlinear system. It consists of a dynamical system and a sign function connected in feedback. It is not captured in the class of systems normally discussed in the literature of nonlinear dynamical systems, because the sign function leads to a discontinuous differential equation.

Relay-based control is the dominating control strategy in practice. Many control methods with a relay component have evolved throughout the years. Several applications and some historical comments are given in Paper 1 and Paper 2. Recent attention is paid to automatic tuning of PID controllers [Åström and Hägglund, 1995], modeling of quantization errors in digital control [Parker and Hess, 1971], and analysis of sigma-delta converters [Aziz *et al.*, 1996]. The relay feedback system can also be viewed as an extremely simple multi-controller system and thus illustrate some of the behaviors of these systems. Switched controllers are surveyed in [Morse, 1995] and it is noticed that results of a more quantitative nature are lacking. Morse claims that there is a need "for a better understanding of the basic properties of switched systems than we have at present." The analysis on relay feedback system provided here is a step in that direction.

Classical analysis of relay feedback system was motivated by electromechanical systems and simple friction models [Andronov *et al.*, 1965; Tsytkin, 1984] as well as by aerospace applications [Flügge-Lotz, 1953; Flügge-Lotz, 1968]. A self-oscillation adaptive system, which has a relay with adjustable amplitude in the feedback loop, has been tested in several American aircrafts [Schuck, 1959]. An early reference to on-off control is [Hawkins, 1887] (pointed out in [Bennett, 1993]). Hawkin studied temperature control and noticed that the relay controller could cause

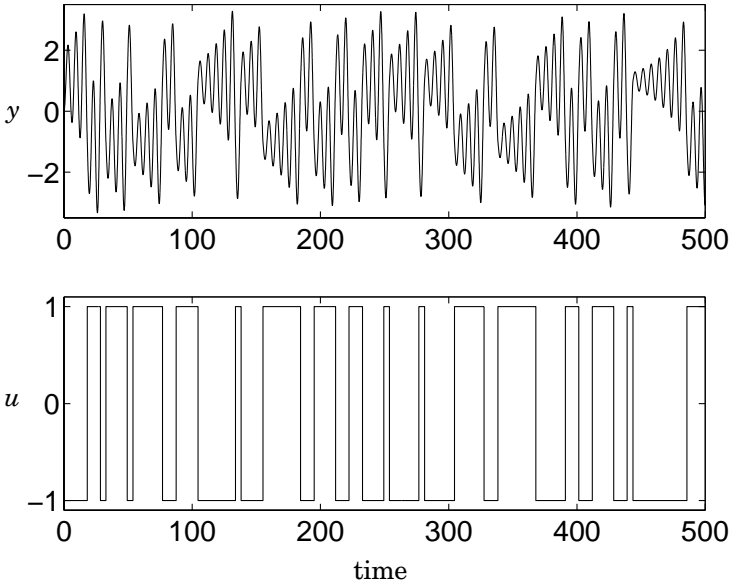

Figure 7. System output y and relay output u for chaotic relay feedback system.

oscillations.

Although relay feedback systems have been studied for more than a century, there are many things that are poorly understood. Simple systems with relay feedback can show complicated responses as is illustrated with the following example.

EXAMPLE 15

Consider a system consisting of a linear part $y = Gu$ with

$$G(s) = -\frac{1}{s^2 - 0.1s + 1}$$

and a relay with unit hysteresis defined by

$$u(t) = \begin{cases} -1, & \text{if } y(t^-) > 1 \text{ and } u(t^-) > 0, \\ 1, & \text{if } y(t^-) < -1 \text{ and } u(t^-) < 0, \\ u(t^-), & \text{otherwise} \end{cases}$$

in the feedback loop. A simulation of this system with initial condition $y(0) = \dot{y}(0) = 0$ and $u(0^+) = -1$ is shown in Figure 7. This system was analyzed and shown to have a chaotic behavior in [Cook, 1985]. A similar

example but with positive steady-state gain is given in [Holmberg, 1991]. \square

This section consists of three parts. First the definition of a relay feedback system is given together with a discussion on existence of solutions and sliding modes. Some results in Paper 1 and Paper 2 are then presented. Finally, some remarks on hybrid systems are given.

Existence of solutions

Linear systems with relay feedback have been studied for a long time [Flügge-Lotz, 1953; Andronov *et al.*, 1965]. A fruitful approach has been to analyze them by harmonic balance, thereby getting estimates of limit cycle periods and amplitudes, see [Atherton, 1975; Tsyppkin, 1984]. An early application of frequency response analysis is [Ångström, 1861]. Conditions for stability of the origin for relay feedback systems were already shown in [Anosov, 1959]. From the analysis therein, it follows roughly that the relay feedback system is stable if the corresponding system with the relay replaced by a high gain is stable. There are still, however, many things concerning linear systems with relay feedback that remain to be investigated.

A linear system with relay feedback is described by the equations

$$\begin{aligned} \dot{x} &= Ax + Bu, \\ y &= Cx, \\ u &= -\operatorname{sgn} y, \end{aligned} \tag{7}$$

where $x \in \mathbf{R}^n$ and

$$\operatorname{sgn} y = \begin{cases} 1, & \text{if } y > 0, \\ -1, & \text{if } y < 0. \end{cases}$$

The sign function is discontinuous at $y = 0$, so existence of solutions does not follow from elementary results about ordinary differential equations. Properties of solutions of differential equations with general discontinuous right-hand sides are derived in Chapter 2 in [Filippov, 1988] by considering differential inclusions. Next, we formally define a solution of (7) and, by referring to a result in [Filippov, 1988], we state that it exists. By rewriting (7) as

$$\dot{x} = Ax - B \operatorname{sgn}(Cx) =: f(x),$$

we get a differential equation with a piecewise continuous right-hand side

given by the function f . Define a set-valued function

$$F(x) := \begin{cases} Ax - B, & \text{if } Cx > 0, \\ Ax + B[-1, 1], & \text{if } Cx = 0, \\ Ax + B, & \text{if } Cx < 0, \end{cases}$$

so that $F(x)$ is a single point in \mathbf{R}^n if $Cx \neq 0$ and otherwise equal to the segment given by $Ax + Bu_0$ for all $u_0 \in [-1, 1]$. A solution to the relay feedback system is defined as an absolutely continuous function¹ that satisfies a differential inclusion given by F .

DEFINITION 4

A solution of the relay feedback system (7) is an absolutely continuous vector-valued function $x(t)$ such that

$$\dot{x}(t) \in F(x(t))$$

almost everywhere. □

Theorem 2.7.1 in [Filippov, 1988] applied to our system gives existence of the solution.

PROPOSITION 7

For any $x_0 \in \mathbf{R}^n$ there exists a solution $x(t)$ for $t \geq 0$ of the relay feedback system (7) such that $x(0) = x_0$. □

Filippov denotes this solution the “simplest convex definition.” If f is affine in u (as it is for a linear system with relay feedback), this definition agrees with the definition using Utkin’s equivalent control [Utkin, 1992]. This is not always the case for other non-smooth right-hand sides f .

Sliding modes and fast relay switches

Trajectories of the relay feedback system (7) for which $y(t) = 0$ on a time interval are called *sliding modes* (or *Filippov solutions*). By considering subsets of the switch plane

$$S := \{x \in \mathbf{R}^n : Cx = 0\}$$

in which also time derivatives of y vanish, it is possible to define higher-order sliding modes [Fridman and Levant, 1996]. For the system (7) we introduce the sliding set of order r as

$$S_r := \{x \in \mathbf{R}^n : Cx = CAx = \dots = CA^{r-1}x = 0\}.$$

¹See [Rudin, 1987] for a definition.

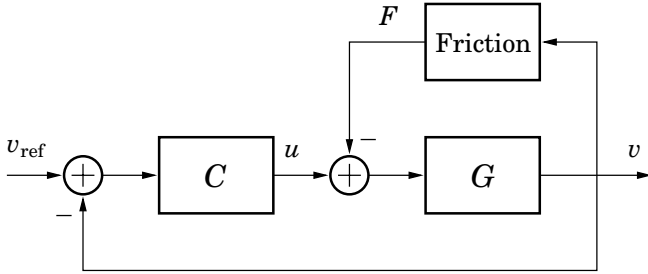

Figure 8. Velocity control system with Coulomb friction.

A part of a solution of (7) that belongs to S_r is then called a sliding mode of order r .

It is easy to see that if the time it takes to pass from one switch plane intersection to another is short, then the initial point must be in the neighborhood of the set $S_2 = \{x \in \mathbf{R}^n : Cx = CAx = 0\}$. Theorem 1 in Paper 1 states that there exists a bounded sequence of points in S giving two consecutive switches with arbitrarily short switch times if and only if the first non-vanishing Markov parameter $CA^k B$ is positive. Furthermore, the switch times for consecutive switches are shown to tend to zero only for systems with pole excess one and two.

Another contribution in Paper 1 is to show that a segment with fast switches can be part of a limit cycle. The simplest case is when first-order sliding is part of the limit cycle. We illustrate with a simple model of a velocity control system with Coulomb friction.

EXAMPLE 16—STICK-SLIP MOTION

Consider the velocity control problem given by

$$\frac{dv}{dt} = u - F,$$

where v is the velocity of a mechanical device of unit mass, u is the control force and F is the friction force. The control system is illustrated in Figure 8 with $G(s) = 1/s$. If no friction is present (*i.e.*, $F \equiv 0$), the integrating control law $u = C(v_{\text{ref}} - v)$ with

$$C(s) = \frac{3s^2 + 2s + 1}{s(s - 1)}$$

gives a closed-loop response with settling time of about six seconds (with a bit too large over-shoot). A friction force $F = \text{sgn } v$ induces a stable os-

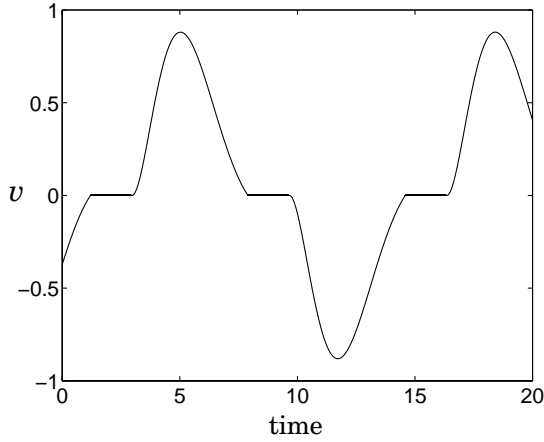

Figure 9. Stick-slip motion in a mechanical control system. The velocity v vanishes part of the limit cycle period.

cillation as shown in Figure 9. Such an oscillation in a mechanical system is called stick-slip motion.

Similar examples but with a more realistic friction model and choice of controller parameters are given in Chapter 4 in [Olsson, 1996]. \square

A necessary and sufficient condition for local stability of the type of limit cycle shown in Figure 9 is proved in Paper 2, by deriving the Jacobian of the Poincaré map consisting of one sliding mode part and one smooth part. The main contribution of that paper, however, is to show that the same method is applicable also for systems that do not have an exact sliding mode. It is shown that the system

$$\dot{x} = \begin{pmatrix} -a_1 & 1 & 0 & \dots & 0 \\ -a_2 & 0 & 1 & & 0 \\ \vdots & & & \ddots & \vdots \\ -a_{n-1} & 0 & 0 & & 1 \\ -a_n & 0 & 0 & \dots & 0 \end{pmatrix} x + \begin{pmatrix} 0 \\ 1 \\ b_1 \\ \vdots \\ b_{n-2} \end{pmatrix} u,$$

$$y = \begin{pmatrix} 1 & 0 & \dots & 0 \end{pmatrix} x$$

can give fast sign shifts in x_2 under relay feedback. These fast switches are denoted *chattering* and they are shown to occur close to the second-order sliding set \mathcal{S}_2 . More precisely, if $x_1(0) = 0$, $x_2(0)$ is small, and $|x_3(0)| < 1$,

then it is proved that the peaks of the chattering is given by

$$x_2(t_k) = (-1)^k x_2(0) \exp \left[-(a_1 - b_1)t_k/3 \right] \left(\frac{1 - x_3^2(t_k)}{1 - x_3^2(0)} \right)^{1/3} + \varepsilon(x_2(0); t_k),$$

where $\varepsilon(x_2(0); t_k)/x_2(0) \rightarrow 0$ as $x_2(0) \rightarrow 0$. Using this result, it is possible to prove local stability of limit cycles with chattering in a similar way as for limit cycles with sliding modes. In particular, it is shown that the complicated Poincaré map with the chattering in x_2 need not be included in the stability analysis, but it is sufficient to study a sliding mode part and a smooth part. A limit cycle with chattering is shown on the front cover, where the chattering variables x_1 and x_2 are given with logarithmic axis. From discussions in Paper 1 it follows that chattering cannot exist for systems with pole excess higher than two. In a sense, the fast behavior in linear systems with relay feedback is completely characterized by the results in Paper 1 and Paper 2.

Hybrid systems

A hybrid system is a dynamical system with both continuous and discrete states. An early reference using the term “hybrid” in this context is [Witsenhausen, 1966] (as pointed out in [van der Schaft and Schumacher, 1996]). There exist several abstract models capturing various hybrid systems, for surveys see [Branicky *et al.*, 1994; Morse, 1995]. A general model presented by Branicky and colleagues consists of a number of vector fields and a transition map. Each vector field defines the system dynamics in a certain set and the transition map tells when the trajectory jumps from one set to another. The deaeration process is an example of a physical system of inherent hybrid nature.

EXAMPLE 17—DEAERATION PROCESS (CONT'D)

The model for the deaeration process described in Example 2 has as discrete state the Boolean variable *evaporation*, which is true if the liquid in the chamber is evaporating and false otherwise. If *evaporation* is true, the continuous states are h and P . The temperature T is then given by the algebraic equation that relates it to pressure. If instead *evaporation* is false, then there are three continuous state variables h , P , and T . Hence, the dimension of the continuous state vector is two at *evaporation* and three at *non-evaporation*. \square

Many hybrid models do not allow changes in the state dimension. One such model is the following given in [Tavernini, 1987]:

$$\begin{aligned} \dot{x}(t) &= f(x(t), u(t)), \\ u(t) &= v(x(t), u(t^-)). \end{aligned} \tag{8}$$

Here x is a continuous state taking values in \mathbf{R}^n and u is a discrete state taking values in an index set I . This system captures many applications in engineering as well as in other sciences. The model fits, for example, computer-controlled systems. It also covers the multi-control structure discussed in [Morse, 1995], where a “supervisor” makes a decision on what controller to run based on process inputs and outputs. Many existing control algorithms have this structure.

Relay feedback systems on the form

$$\begin{aligned} \dot{x} &= f(x, u), \\ y &= c(x), \\ u &= -\operatorname{sgn} y \end{aligned} \tag{9}$$

belongs to all classes of hybrid systems previously discussed. In a relay feedback system the dynamics are only switched between two vector fields $f(x, 1)$ and $f(x, -1)$. It is thus, in some sense, the simplest of all hybrid systems. It is interesting to characterize the behavior in such a prototype system to be able to understand more complicated hybrid systems.

The switch characteristic in a physical model is sometimes derived from a simplification of a complex model. For example, rather than using a sophisticated function that describes the relation between current and voltage for an electrical diode, an ideal diode model that only consists of a switch may be preferred. In this context it is important to note that the solution of the non-smooth differential equation (9) may depend on the definition of the sliding mode. (Recall from the previous discussion that if the vector field f is not affine in u , there can be an ambiguity of the solution of (9).) Reducing complexity may thus introduce a model with a non-unique solution. This raises questions connected to modeling and simulation, see [Mattson, 1996; Malmberg and Bernhardsson, 1996].

4. Automatic Tuning Using Relay Feedback

A particular application of relay feedback is the automatic tuning method proposed in [Åström and Hägglund, 1984a]. It was motivated from the industrial need of a simple and robust method for tuning PID controllers. Recent reports on the status of control in industry include [Bialkowski, 1992; Ender, 1993; Hersh and Johnson, 1997]. These papers emphasize the need for methods of retuning loops that perform poorly.

Because of the limited knowledge of control design methods in process industry, it is highly desirable to have simple tuning methods. Most model-based design algorithms require a significant amount of engineering knowledge: some parameters have to be adjusted in a non-trivial way

until a satisfactory design is achieved. This is, for example, the case when locating closed-loop poles in a pole-placement design or choosing weighting matrices in H_2 and H_∞ designs. If we accept to reduce the generality of the model-based design methods, it is possible to derive more restricted methods for designing controllers. To emphasize these restrictions we use the term *tuning* rather than *design*.

A survey on relay feedback methods for both scalar and multivariable controller tuning is given in [Åström *et al.*, 1995]. Paper 5 gives also a quite broad overview. Therefore, we include in this section only a short introduction to the original method and illustrate some of the difficulties that may appear in the multivariable case. Finally, a discussion on open problems is given.

Tuning of SISO controllers

A classical paper on controller tuning is [Ziegler and Nichols, 1942]. Ziegler and Nichols pointed out that tuning of PID controllers for many industrial processes can be based on the ultimate period T_u and the corresponding gain K_u . The ultimate gain K_u is defined as the value “above which any oscillation will increase to some maximum amplitude, and below which an oscillation of any size will diminish.” For a system of the form $G(s) = K \exp(-sL)/(1 + sT)$, with $K, L, T > 0$, this means that the ultimate point is the outer most point for which the Nyquist curve intersects the negative real axis. Ziegler and Nichols gave three simple formulas for the parameters in a PID controller. Translated to the controller parameterization

$$C(s) = K \left(1 + \frac{1}{T_i s} + T_d s \right)$$

they are

$$K = 0.6K_u, \quad T_i = 0.5T_u, \quad T_d = 0.125T_u, \quad (10)$$

see [Åström and Häggglund, 1995]. Later Ziegler and Nichols’ formulas have been improved [Hang *et al.*, 1991; Åström and Häggglund, 1995], but the basic idea, that from a simple experiment automatically derive controller parameters, remains.

Controller parameters can be automatically tuned by the device shown in Figure 10. The switch is first set to relay mode and the ultimate period T_u and the ultimate gain K_u are obtained from the likely induced oscillation. Then the controller parameters can be automatically calculated from formulas as (10) and the switch finally set to controller mode. The main advantages with the relay feedback method for automatic tuning are that

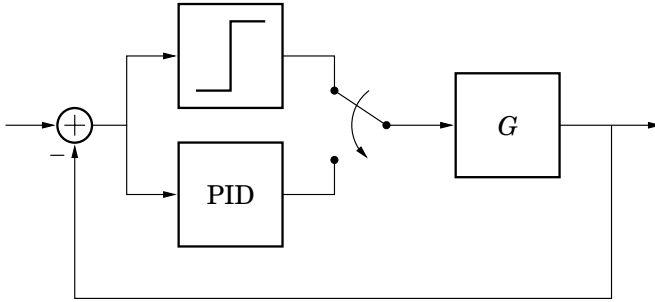

Figure 10. Automatic tuning of PID controller using relay feedback.

- the estimated model will have high accuracy in the important region around the cross-over frequency for the open-loop system;
- the experiment is done in closed-loop; and
- no prior knowledge about the process dynamics is needed.

These are some of the reasons for why the method works well in practice. It is adopted by many manufactures [Åström and Hägglund, 1995]. A historical review of the development of the relay autotuner at Lund Institute of Technology is given in Chapter 7 in [Dagnegård and Hägglund, 1996].

The reason for that the limited information provided by a single oscillation is sufficient in many applications is that often a remarkable simple and crude model of the plant is enough to gain improved control performance. The amount of process information required for control is discussed in [Persson, 1992]. A more accurate model in terms of higher-order dynamics may not be sufficiently cost effective. Bellman pointed out that “it should be constantly kept in mind that the mathematical system is never more than a projection of the real system on a conceptual axis” (page 186 in [Bennett, 1993]). For many industrial process control problems, experience has shown that it suffices to let the “axis” be low-order linear models, such as first-order lags with a time delay.

The relay feedback experiment can easily be modified to give more than one point on the Nyquist curve by adding a filter in series with the relay. This is further discussed in Paper 5. Combining the filtering with a relay connected between the system output and reference input is done in [Schei, 1992]. Versions of the relay tuning method for scalar controllers include [Friman and Waller, 1995], wherein the relay is replaced with other nonlinearities, and [Levant, 1997], wherein the transient prior to the steady oscillation is used to improve the estimate. Uncertainty bounds for robust control are estimated via relay feedback experiments in [Smith

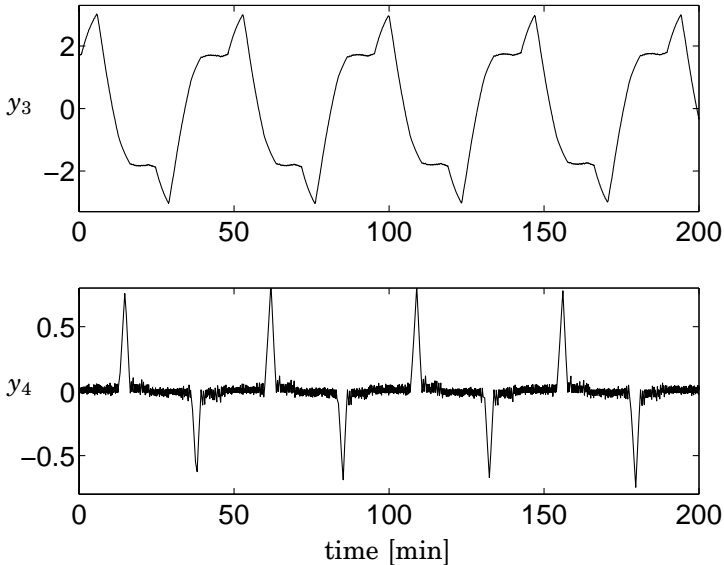

Figure 11. A decentralized relay experiment that gives a complex oscillation for the heavy oil fractionator model.

and Doyle, 1993]. Examples of non-relay tuning methods are given in [Gawthroy and Nomikos, 1990; Woodyatt and Middleton, 1997].

Tuning of MIMO controllers

As quality demands increase, interacting control loops become more and more important. There is a need for simple tuning methods also for MIMO controllers. It is therefore natural to try to extend the relay feedback method to multivariable systems. Several attempts exist in the literature, see [Åström *et al.*, 1995], [Wang *et al.*, 1997], and Paper 5 for references. Most of these methods are limited to diagonal controllers consisting of m PID controllers, where m is the number of inputs and outputs.

In the multivariable methods for relay tuning either one relay or m relays are used simultaneously. In the first case, relay experiments similar to the scalar experiment are applied in a sequential manner: one loop is put under relay feedback and its controller parameters are adjusted, then another loop is put under relay feedback and its parameters are adjusted etc. until all m loops have been tuned. This type of tuning is, for example, described in [Hang *et al.*, 1993; Friman, 1997]. In the method with m relays, all loops are put under relay feedback simultaneously. This is sometimes called a decentralized relay experiment. Under the assumption that a pure oscillation with one frequency occurs in all loops,

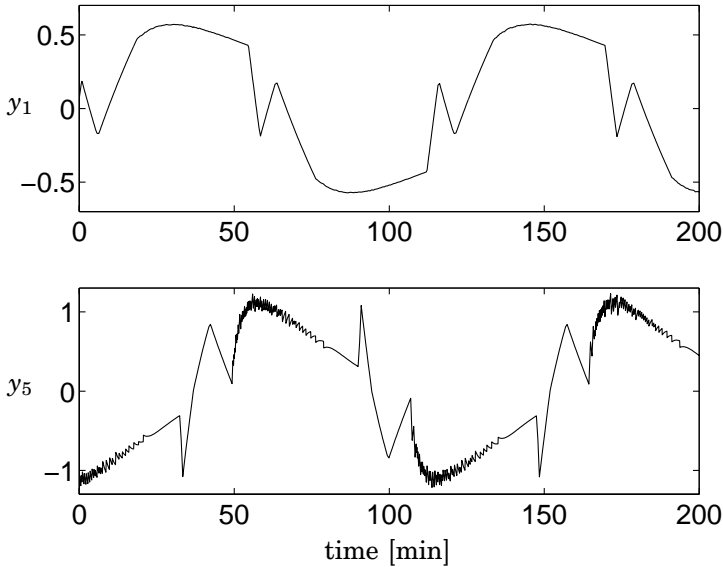

Figure 12. Another decentralized relay experiment that gives a complex oscillation for the heavy oil fractionator model.

controller parameters can be derived [Palmor *et al.*, 1995; Wang *et al.*, 1997].

A major advantage with the sequential tuning method is that it is based on the scalar relay experiment, which are known to work well in practice. A decentralized relay experiment can give extremely complex oscillations for models of real plants, as is illustrated by the following example.

EXAMPLE 18—HEAVY OIL FRACTIONATOR (CONT'D)

Consider Shell's model of an oil fractionator in Example 3. Connect relays with unit amplitude and hysteresis equal to 0.01 in the configuration (1–1,2–2,3–3,4–4,5–5), that is, relay between process input 1 and output 1, process input 2 and output 2 etc. Such an experiment gives a complicated response. The outputs y_3 and y_4 are shown in Figure 11 after the transients have disappeared. The relay configuration (1–6,2–7,3–3,4–4,5–5) gives the y_1 and y_5 responses in Figure 12. It is not a simple task to draw conclusions from experiments of this type. \square

It is shown in [Wang *et al.*, 1997] that the decentralized relay method works in a number of simulated examples. However, adding the complexity of a real system, it seems rather unlikely that a plant operator would accept the excitation of relays in all loops simultaneously (for exam-

ple, such excitation is rarely tolerable in pulp and paper industry [Adler, 1994]).

Paper 5 introduces a new method for retuning individual control loops in a multivariable controller. The control can be a decentralized PID controller or a centralized MIMO controller. The method is based on single-relay experiments and is therefore related to the sequential methods previously mentioned.

Lack of theory

Many methods for controller tuning based on relay feedback work very well both in simulations and in real implementations. This holds in particular for the original method developed by Åström and Hägglund. Still, there are several unsolved problems regarding application of the relay feedback methods. A major one is concerned with analysis of relay feedback systems.

All systems do not possess a limit cycle oscillation when they are put under relay feedback. This may seem obvious from a system theoretical point of view, but there are certainly many misunderstandings or exaggerated statements in the literature like “It is well known that a SISO system in closed-loop with a relay controller oscillates in a limit cycle whose amplitude and frequency are related to the characteristics of the critical point on the Nyquist plot” [Semino *et al.*, 1996]. Many systems *do* oscillate with such an amplitude and frequency, but not all. An example of the latter is given in Example 16. The following fundamental problem is still open:

What is the class of systems that give a unique and stable limit cycle under relay feedback?

This question was indeed the starting point for part of the work in this dissertation. Some answers exist for special classes of systems. Systems of low order are studied in [Holmberg, 1991]. It is, for example, shown that the transfer function

$$G(s) = \frac{K}{1 + sT} e^{-sL}$$

with relay feedback gives a globally attractive limit cycle under mild assumptions. This is also shown for general stable infinite-dimensional systems with impulse responses of a certain shape in [Megretski, 1996].

A simple method to investigate the global behavior of a stable linear

system with relay feedback

$$\begin{aligned}\dot{x} &= Ax + Bu, \\ y &= Cx, \\ u &= -\operatorname{sgn} y\end{aligned}$$

is to study a set recursion

$$X_k = g(X_{k-1}).$$

Here X_k is a connected set in $S_+ := \{x \in S : CAx - CB > 0\}$, where $S := \{x \in \mathbf{R}^n : Cx = 0\}$ is the switch plane. The function $g : S_+ \rightarrow S_+$ is the map from one switch plane intersection to the next one reflected in the origin. If the recursion is initialized with

$$X_0 = \{x \in S : CAx - CB = 0\} \cup \{x \in S : CAx - CB > 0, |x| \leq R\},$$

for a sufficiently large R , then the global behavior will be captured. This follows from that A is a Hurwitz matrix and $|u| \leq 1$, so there exists a globally attractive and invariant ball $\{x : |x| \leq R\}$, compare [Hsu, 1990]. The method is easy to visualize for systems of order three and less, as is illustrated with the following example from [Johansson and Rantzer, 1996a].

EXAMPLE 19

Consider the system

$$\begin{aligned}\dot{x} &= \begin{pmatrix} -1 & 0 & 0 \\ -1 & -2 & 0 \\ 3 & -3 & -3 \end{pmatrix} x + \begin{pmatrix} 1 \\ 1 \\ 0 \end{pmatrix} u, \\ y &= \begin{pmatrix} 0 & 0 & 1 \end{pmatrix} x.\end{aligned}$$

Then, $S = \{x : x_3 = 0\}$ and $S_+ = \{x \in S : x_1 > x_2\}$. Let X_0 be a semicircle disc with radius 80. Figure 13 shows the set recursion under four iterations. The first diagram shows X_0 together with X_1 (drawn with thicker lines), the second X_1 and X_2 etc. In the last diagram the fixed point $x^* = (0.45, 0.30, 0)$ is marked by an asterisk. The contraction is remarkably fast, in particular during the first two iterations. This agrees with the behavior of first-order and second-order systems with time-delay analyzed in [Holmberg, 1991] and the practical experience of relay feedback control discussed in [Åström and Hägglund, 1984]. \square

For a class of third-order systems it is possible to prove global area contraction as the one shown in Figure 13, see [Johansson and Rantzer, 1996a; Johansson and Rantzer, 1996b].

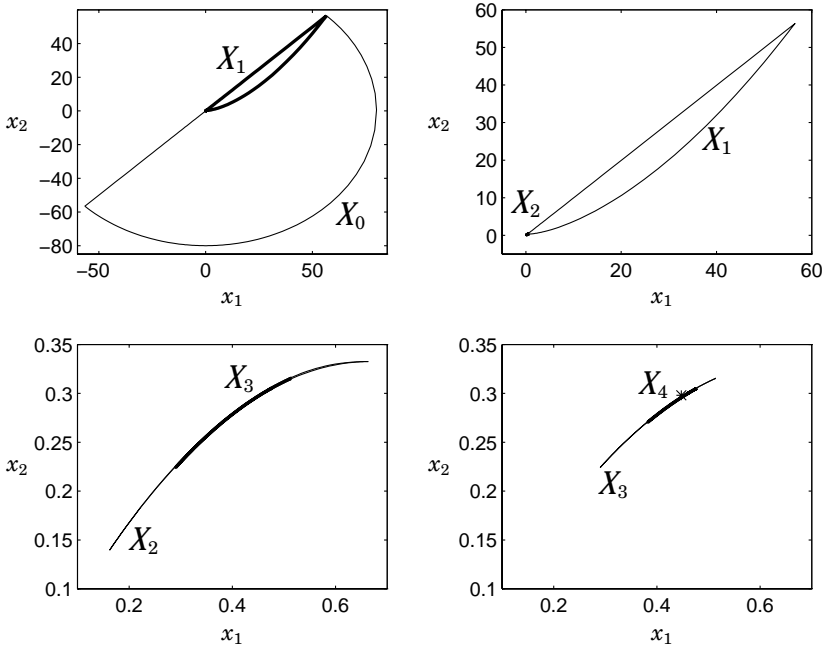

Figure 13. Area contraction of switch plane intersections for the third-order system in Example 19.

5. References

- ADLER, L. S. (1994): Manager, Systems & Products, ABB Industrial Systems Inc., Personal communication.
- ANDERSON, B. D. O. and J. B. MOORE (1989): *Optimal Control—Linear Quadratic Methods*. Prentice-Hall, Englewood Cliffs, NJ.
- ANDRONOV, A. A., S. E. KHAIKIN, and A. A. VITT (1965): *Theory of oscillators*. Pergamon Press, Oxford.
- ÅNGSTRÖM, A. I. (1861): “Neue Methode, das Wärmeleitungsvermögen der körper zu bestimmen.” *Annalen der Physik und Chemie*, **114**, pp. 513–530.
- ANOSOV, D. V. (1959): “Stability of the equilibrium positions in relay systems.” *Automation and Remote Control*, **20**, pp. 135–149.
- ANTONIOU, A. and I. GARRETT (1993): “To what extent did stock index futures contribute to the October 1987 stock market crash.” *The Economic Journal*, **103**, November, pp. 1444–1461.

- ARNFIELD, R. (1988): "U.S. task force blames program trading for stock market crash." *Electronic Banking & Finance*, **4:12**.
- ÅSTRÖM, K. J. (1996): "Fundamental limitations of control system performance." In PAULRAJ *et al.*, Eds., *Mathematical Engineering: A Kailath Festschrift*. Kluwer Academic Publishers.
- ÅSTRÖM, K. J. and T. HÄGGLUND (1984a): "Automatic tuning of simple regulators." In *Preprints 9th IFAC World Congress*, pp. 267–272. Budapest, Hungary.
- ÅSTRÖM, K. J. and T. HÄGGLUND (1984b): "Automatic tuning of simple regulators with specifications on phase and amplitude margins." *Automatica*, **20**, pp. 645–651.
- ÅSTRÖM, K. J. and T. HÄGGLUND (1995): *PID Controllers: Theory, Design, and Tuning*, second edition. Instrument Society of America, Research Triangle Park, NC.
- ÅSTRÖM, K. J., T. H. LEE, K. K. TAN, and K. H. JOHANSSON (1995): "Recent advances in relay feedback methods—a survey." In *IEEE SMC Conference*, pp. 2616–2621. Vancouver, WA. Invited paper.
- ATHERTON, D. P. (1975): *Nonlinear Control Engineering: Describing Function Analysis and Design*. Van Nostrand Reinhold Co., London, U.K.
- AZIZ, P. M., H. V. SORENSSEN, and J. VAN DER SPIEGEL (1996): "An overview of sigma-delta converters." *IEEE Signal Processing Magazine*, January, pp. 61–84.
- BENNETT, S. (1993): *A History of Control Engineering*. Peter Peregrinus Ltd, London, U.K.
- BIALKOWSKI, W. L. (1992): "Dreams vs reality: A view from both sides of the gap." In *Control Systems '92*. Whistler, B.C., Canada.
- BODE, H. W. (1945): *Network Analysis and Feedback Amplifier Design*. Van Nostrand, New York, NY.
- BOYD, S. P. and C. H. BARRATT (1991): *Linear Controller Design—Limits of Performance*. Prentice-Hall, Englewood Cliffs, NJ.
- BRANICKY, M. S., V. S. BORKAR, and S. K. MITTER (1994): "A unified framework for hybrid control." In *IEEE Conference on Decision and Control*. Lake Buena Vista, FL.
- BRISK, M. L. (1993): "Process control: Theories and profits." In *Preprints 12th IFAC World Congress*, vol. 7, pp. 241–250. Sydney, Australia.

- BRYANT, G. F. and L. F. YEUNG (1996): *Multivariable Control System Design Techniques: Dominance and Direct Methods*. Wiley.
- COOK, P. A. (1985): "Simple feedback systems with chaotic behaviour." *Systems & Control Letters*, **6**, pp. 223–227.
- CUTLER, C. R. and B. C. RAMAKER (1980): "Dynamic matrix control—A computer control algorithm." In *Proceedings Joint Automatic Control Conference*, Paper WP5-B. San Francisco, CA.
- DAGNEGÅRD, E. and T. HÄGGLUND (1996): "Activity report 1995–1996." Report ISRN LUTFD2/TFRT-4024--SE. Department of Automatic Control, Lund Institute of Technology, Lund, Sweden.
- DOYLE, J. C. (1992): "Analysis of feedback systems with structured uncertainties." *IEEE Proceedings, Part D*, **129**, pp. 242–250.
- DOYLE, J. C., B. A. FRANCIS, and A. R. TANNENBAUM (1992): *Feedback Control Theory*. Macmillan, New York, NY.
- ENDER, D. B. (1993): "Process control performance: Not as good as you think." *Control Engineering*, **40:10**, pp. 180–190.
- FIELDING, C. (1997): "The design of fly-by-wire flight control systems." In *Symposium on Quantitative Feedback Theory and Other Frequency-Based Methods and Applications*. Glasgow, Scotland.
- FILIPPOV, A. F. (1988): *Differential Equations with Discontinuous Right-hand Sides*. Kluwer Academic Publishers.
- FLÜGGE-LOTZ, I. (1953): *Discontinuous Automatic Control*. Princeton University Press.
- FLÜGGE-LOTZ, I. (1968): *Discontinuous and Optimal Control*. McGraw-Hill, New York, NY.
- FRANCIS, B. A. (1987): *A Course in H_∞ Control Theory*. Springer-Verlag, Berlin, Germany.
- FREUDENBERG, J. and D. LOOZE (1988): *Frequency Domain Properties of Scalar and Multivariable Feedback Systems*. Springer-Verlag, Berlin, Germany.
- FREUDENBERG, J. S. and D. P. LOOZE (1985): "Right half plane poles and zeros and design tradeoffs in feedback systems." *IEEE Transactions on Automatic Control*, **30:6**, pp. 555–565.
- FREUDENBERG, J. S. and D. P. LOOZE (1987): "A sensitivity tradeoff for plants with time delay." *IEEE Transactions on Automatic Control*, **32:2**, pp. 99–104.

- FRIDMAN, L. M. and A. LEVANT (1996): "Higher order sliding modes as a natural phenomenon in control theory." In GAROFALO AND GLIELMO, Eds., *Robust Control via Variable Structure & Lyapunov Techniques*, vol. 217 of *Lecture notes in control and information science*, pp. 107–133. Springer-Verlag.
- FRIMAN, M. (1997): *Extensions and modifications of relay autotuning*. PhD thesis, Dept. of Chemical Eng., Åbo Akademi University.
- FRIMAN, M. and K. V. WALLER (1995): "Closed-loop identification by use of single-valued nonlinearities." *Ind. Eng. Chem. Res.*, **34**, pp. 3052–3058.
- GAWTHROP, P. J. and P. E. NOMIKOS (1990): "Automatic tuning of commercial PID controllers for single-loop and multiloop applications." *IEEE Control Systems Magazine*, January, pp. 34–42.
- GOLUB, G. H. and C. F. VAN LOAN (1989): *Matrix Computations*. The John Hopkins University Press, Baltimore, MD.
- GÓMEZ, G. I. and G. C. GOODWIN (1996): "Integral constraints on sensitivity vectors for multivariable linear systems." *Automatica*, **32:4**, pp. 499–518.
- GÓMEZ, G. I. and G. C. GOODWIN (1997): "Generalization of integral constraints on sensitivity to time delay systems." Unpublished manuscript.
- GOODWIN, G. C. (1997): "Defining the performance envelope in industrial control." In *16th American Control Conference*. Albuquerque, NM. Plenary Session I.
- GUCKENHEIMER, J. and P. HOLMES (1983): *Nonlinear Oscillations, Dynamical Systems and Bifurcations of Vector Fields*. Springer-Verlag, Berlin, Germany.
- HANG, C. C., K. J. ÅSTRÖM, and W. K. HO (1991): "Refinements of the Ziegler-Nichols tuning formula." *IEE Proceedings, Part D*, **138:2**, pp. 111–118.
- HANG, C. C., T. H. LEE, and W. K. HO (1993): *Adaptive Control*. Instrument Society of America, Research Triangle Park, NC.
- HAWKINS, J. T. (1887): "Automatic regulators for heating apparatus." *Trans. American Society of Mechanical Engineers*, **9**, p. 432.
- HERSH, M. A. and M. A. JOHNSON (1997): "A study of advanced control systems in the work place." *Control Eng. Practice*, **5:6**, pp. 771–778.

Introduction

- HOLMBERG, U. (1991): *Relay Feedback of Simple Systems*. PhD thesis TFRT-1034, Department of Automatic Control, Lund Institute of Technology, Lund, Sweden.
- HORN, R. A. and C. R. JOHNSON (1996): *Matrix Analysis*. Cambridge University Press.
- HOROWITZ, I. (1979): "Quantitative synthesis of uncertain multiple input-output feedback systems." *International Journal of Control*, **30**, pp. 81–106.
- HOROWITZ, I. M. (1963): *Synthesis of Feedback Systems*. Academic Press, New York, NY.
- HSU, L. (1990): "Boundedness of oscillations in relay feedback systems." *International Journal of Control*, **52:5**, pp. 1273–1276.
- ISERMANN, R. (1995): "Mechatronic systems—A challenge for the design of intelligent control systems." In *European Control Conference*, pp. 2708–2713. Rome, Italy.
- JOHANSSON, K. H. (1994): "An automatic start-up procedure for multivariable control systems." Report ISRN LUTFD2/TFRT-7526--SE. Department of Automatic Control, Lund Institute of Technology, Lund, Sweden.
- JOHANSSON, K. H. (1996): "Performance limitations in coordinated control." In *EURACO Workshop on Robust and Adaptive Control of Integrated Systems*. Munich, Germany.
- JOHANSSON, K. H. (1997): "Modeling and control of a deaeration process." Unpublished manuscript.
- JOHANSSON, K. H., T. HÄGGLUND, and K. J. ÅSTRÖM (1994): "An automatic start-up procedure for multivariable control systems." In *Preprints Reglermöte 94*. Västerås, Sweden.
- JOHANSSON, K. H. and J. L. R. NUNES (1997): "A multivariable laboratory process with an adjustable zero." Submitted to 17th American Control Conference.
- JOHANSSON, K. H. and A. RANTZER (1996a): "Global analysis of third-order relay feedback systems." In *Preprints IFAC 13th World Congress*, vol. E, pp. 55–60. San Francisco, CA.
- JOHANSSON, K. H. and A. RANTZER (1996b): "Global analysis of third-order relay feedback systems." Report ISRN LUTFD2/TFRT-7542--SE. Department of Automatic Control, Lund Institute of Technology, Lund, Sweden.

- KAILATH, T. (1980): *Linear Systems*. Prentice-Hall, Inc, Englewood Cliffs, NJ.
- LEVANT, A. (1997): "Higher order sliding: Collection of design tools." In *European Control Conference*. Brussels, Belgium.
- MACIEJOWSKI, J. M. (1989): *Multivariable Feedback Design*. Addison-Wesley, Reading, MA.
- MALMBORG, J. and B. BERNHARDSSON (1996): "Implementation and simulation of hybrid control systems." In *Second World Congress of Nonlinear Analysts*. Athens, Greece.
- MATTSON, S. E. (1996): "On object-oriented modelling of relays and sliding mode behaviour." In *Preprints IFAC 13th World Congress*, vol. F, pp. 259–264. San Francisco, CA.
- MAYNE, D. Q. (1979): "Sequential design of linear multivariable systems." *Proc. IEE*, **126:6**, pp. 568–572.
- MEGRETSKI, A. (1996): "Global stability of oscillations induced by a relay feedback." In *Preprints IFAC 13th World Congress*, vol. E, pp. 49–54. San Francisco, CA.
- MIDDLETON, R. H. (1991): "Trade-offs in linear control system design." *Automatica*, **27:2**, pp. 281–292.
- MOORE, C. (1986): "Application of singular value decomposition to the design, analysis, and control of industrial processes." In *Proc. American Control Conference*, pp. 643–650.
- MORARI, M. and E. ZAFIRIOU (1989): *Robust Process Control*. Prentice-Hall, Englewood Cliffs, NJ.
- MORSE, A. S. (1995): "Control using logic-based switching." In ISIDORI, Ed., *Trends in Control. A European Perspective*, pp. 69–113. Springer.
- OGUNNAIKE, B. A. and W. H. RAY (1994): *Process Dynamics, Modeling, and Control*. Oxford University Press, New York, NY.
- OLSSON, H. (1996): *Control Systems with Friction*. PhD thesis ISRN LUTFD2/TFRT--1045--SE, Department of Automatic Control, Lund Institute of Technology, Lund, Sweden.
- PALMOR, Z. J., Y. HALEVI, and N. KRASNEY (1995): "Automatic tuning of decentralized PID controllers for TITO processes." *Automatica*, **31:7**, pp. 1001–1010.
- PARKER, S. R. and S. F. HESS (1971): "Limit cycle oscillations in digital filters." *IEEE Trans. Circ. Theory*, **CT-18**, pp. 687–697.

- PERSSON, P. (1992): *Towards Autonomous PID Control*. PhD thesis ISRN LUTFD2/TFRT-1037--SE, Department of Automatic Control, Lund Institute of Technology, Lund, Sweden.
- PRETT, D. M., C. E. GARCÍA, and B. L. RAMAKER (1990): *The Second Shell Process Control Workshop*. Butterworths.
- QUI, L. and E. J. DAVISON (1993): "Performance limitations of non-minimum phase systems in the servomechanism problem." *Automatica*, **29:2**, pp. 337–349.
- ROSENBROCK, H. H. (1969): "Design of multivariable control systems using the inverse Nyquist array." In *Proc. IEE*, vol. 116, pp. 1929–1936.
- ROSENBROCK, H. H. (1970): *State-Space and Multivariable Theory*. Nelson, London, U.K.
- ROSENBROCK, H. H. (1974): *Computer-Aided Control System Design*. Academic Press, London, U.K.
- RUDIN, W. (1987): *Real and complex analysis*, third edition. McGraw-Hill, New York, NY.
- RUGH, W. J. (1993): *Linear system theory*. Prentice-Hall.
- SCHEI, T. S. (1992): "A method for closed loop automatic tuning of PID controllers." *Automatica*, **28:3**, pp. 587–591.
- SCHUCK, O. H. (1959): "Honeywell's history and philosophy in the adaptive control field." In GREGORY, Ed., *Proc. Self Adaptive Flight Control Symposium*. Wright Air Development Center, Wright Patterson AFB, Ohio.
- SEMINO, D., I. MAZZANTI, and C. SCALI (1996): "Design of decentralized controllers by a relay technique: Extensions of tuning rules." In *UKACC International Conference on Control*. IEE.
- SERON, M. M., J. H. BRASLAVSKY, and G. C. GOODWIN (1997a): *Fundamental Limitations in Filtering and Control*. Springer-Verlag.
- SERON, M. M., J. H. BRASLAVSKY, P. V. KOKOTOVIĆ, and D. Q. MAYNE (1997b): "Feedback limitations in nonlinear systems: From Bode integrals to cheap control." Technical Report CCEC 97-0304. Center for Control Engineering and Computations, University of California, Santa Barbara, CA.
- SERON, M. M. and G. C. GOODWIN (1996): "Sensitivity limitations in nonlinear feedback control." *Systems & Control Letters*, **27**, pp. 249–254.

- SHAMMA, J. (1991): "Performance limitations in sensitivity reduction for nonlinear plants." *Systems & Control Letters*, **17**, pp. 43–47.
- SHANNON, C. E. (1948): "A mathematical theory of communication." *Bell System Tech. J.*, **27**, pp. 379–423, 623–656.
- SIAMANTAS, G. G. (1994): "Examples of multivariable control systems." Master thesis. University of Manchester Institute of Science and Technology.
- SINGH, K. (1987): "Examples of multivariable control systems." Master thesis. The Victoria University of Manchester.
- SKOGESTAD, S. and I. POSTLETHWAITE (1996): *Multivariable Feedback Control—Analysis and Design*. John Wiley & Sons.
- SKOGLUND, T. (1996): Technical Manager, Tetra Pak Processing Systems AB, Personal communication.
- SMITH, R. S. and J. C. DOYLE (1993): "Closed loop relay estimation of uncertainty bounds for robust control models." In *Preprints 12th IFAC World Congress*, vol. 9, pp. 57–60. Sydney, Australia.
- STEIN, G. (1990): "Respect the unstable." In *30th IEEE Conference on Decision and Control*. Honolulu, HI.
- TAVERNINI, L. (1987): "Differential automata and their discrete simulators." *Nonlinear analysis, theory, methods, and applications*, **11:6**, pp. 665–683.
- TSYPKIN, YA. Z. (1984): *Relay Control Systems*. Cambridge University Press, Cambridge, U.K.
- UTKIN, V. I. (1992): *Sliding Modes in Control Optimization*. Springer-Verlag, Berlin.
- VAN DER SCHAFT, A. J. and J. M. SCHUMACHER (1996): "The complementary-slackness class of hybrid systems." *Mathematics of control, signals, and systems*, **9**, pp. 266–301.
- WANG, Q. G., B. ZOU, T. H. LEE, and Q. BI (1997): "Auto-tuning of multivariable PID controllers from decentralized relay feedback." *Automatica*, **33:3**, pp. 319–330.
- WINTERBONE, D. E., N. MUNRO, and P. M. G. LOURTIE (1973): "A preliminary study of the design of a controller for an automotive gas turbine." *Journal of Engineering for Power*, **95**, pp. 244–250.
- WITSENHAUSEN, H. S. (1966): "A class of hybrid-state continuous-time dynamic systems." *IEEE Transactions on Automatic Control*, **11:2**, pp. 161–167.

Introduction

- WOODYATT, A. R. and R. H. MIDDLETON (1997): "Auto-tuning PID controller design using frequency domain approximation." In *European Control Conference*. Brussels, Belgium.
- ZAMES, G. (1981): "Feedback and optimal sensitivity: Model reference transformations, multiplicative seminorms and approximate inverses." *IEEE Transactions on Automatic Control*, **AC-26**, pp. 301–320.
- ZAMES, G. and D. BENSOUSSAN (1983): "Multivariable feedback, sensitivity, and decentralized control." *IEEE Transactions on Automatic Control*, **28:11**, pp. 1030–1035.
- ZHOU, K., J. C. DOYLE, and K. GLOVER (1996): *Robust and Optimal Control*. Prentice Hall.
- ZIEGLER, J. G. and N. B. NICHOLS (1942): "Optimum settings for automatic controllers." *Trans. ASME*, **64**, pp. 759–768.

Paper 1

Fast Switches in Relay Feedback Systems

**Karl Henrik Johansson, Anders Rantzer,
and Karl Johan Åström**

Abstract

Relays are common in automatic control systems. Even linear systems with relay feedback are, however, far from fully understood. New results are given about the behavior of these systems via a state-space approach. It is proved that there exist multiple fast switches if and only if the sign of the first non-vanishing Markov parameter of the linear system is positive. Fast switches are shown to occur as part of stable limit cycles. An analysis is developed for these limit cycles that illustrates how they can be predicted.

1. Introduction

Analysis of relay feedback systems is a classical topic in control theory. The early work was motivated by relays in electromechanical systems and simple models for dry friction. The design of relay controllers in aerospace applications [Flügge-Lotz, 1953; Flügge-Lotz, 1968] gave inspiration to the development of the self-oscillating adaptive controller in the 1960s. Recently new interest of relay feedback appeared due to the idea of using relays for tuning simple controllers in [Åström and Hägglund, 1984]. By simply replacing the controller by a relay, measure the amplitude and frequency of the possible oscillation, and out of these derive the controller parameters, a robust control design method is obtained. Although this method is now widely used in industry [Åström and Hägglund, 1995], there are several issues that need further theoretical analysis. One problem is to characterize those systems that will give a unique globally attractive limit cycle. This problem is important because it gives the class of systems when relay tuning can be used. The idea of putting the plant under relay feedback is also used in other applications. In [Smith and Doyle, 1993] perturbation bounds are estimated for robust control design and in [Lundh and Åström, 1994] it is shown how initialization of adaptive controllers can be done. Quantization in digital control can be analyzed with relay feedback methods. Limit cycles due to quantizers are reported in [Parker and Hess, 1971]. Relays are key components in variable-structure systems, see [Utkin, 1987]. More applications of relays in control systems are given in [Tsytkin, 1984; Åström, 1995]. The monograph [Andronov *et al.*, 1965] is an early classical reference (first edition published in Russian in 1937) discussing oscillations in relay feedback systems using phase-plane analysis.

Analysis of linear systems with relay feedback is a nontrivial task. The major reference about relay control systems [Tsytkin, 1984] surveys a number of analysis methods and results. For example, an intuitive stability condition is given therein. It says roughly that if a linear system is stable with arbitrarily large proportional feedback, it is also stable with relay feedback. The statement is formally proved in [Anosov, 1959]. Other applicable stability results, valid for a more general class of nonlinearities, are given in [Yakubovich, 1964]. A non-smooth Lyapunov stability theory is developed in [Shevitz and Paden, 1994]. Relay feedback systems often tend to a limit cycle. Methods for estimating oscillation frequency and amplitude are thoroughly discussed in [Tsytkin, 1984], see also [Atherton, 1975; Mees, 1981]. It is important to note that all these frequency methods are derived under the assumption that a limit cycle exists. To tell in general if a relay feedback system actually converges to a limit oscillation is an open problem. In [Yakubovich, 1973] a frequency condi-

tion is used to give sufficient conditions for a certain type of oscillations. For second-order systems, convergence analysis can be done in the phase-plane. Stable second-order nonminimum phase systems can in this way be shown to have a globally attractive limit cycle [Holmberg, 1991]. In [Megretski, 1996] it is proved that this also holds for systems having an impulse response sufficiently close, in a certain sense, to a second-order nonminimum phase system.

Relay feedback systems may exhibit several interesting behaviors. The main contribution of our work is to investigate some of these behaviors and state a number of new results to improve the understanding of linear systems with relay feedback. Particular emphasis is on fast switches and their properties. It is shown that a necessary and sufficient condition for multiple fast switches is that the sign of the first non-vanishing Markov parameter is positive. This result can be seen as a generalization of the existence of regular (or first-order) sliding modes in relay feedback systems discussed in [Tsytkin, 1984; Filippov, 1988]. The condition for fast switches in third-order systems is given in [Johansson and Rantzer, 1996]. Here, the condition is generalized to systems of arbitrary order. An application of the result is to predict fast switches as part of limit cycles. This is done in the latter part of the paper, where it is also shown how these complicated limit cycles can be analyzed using Utkin's equivalent control [Utkin, 1987].

There exists necessary and sufficient conditions for local stability of limit cycles in the literature. Two important ones are given in [Åström and Hägglund, 1984a] and [Balasubramanian, 1981], respectively. The conditions are recalled here and it is shown that they are equivalent if the pole excess of the linear system is greater than one.

The outline of the paper is as follows. Some notations and assumptions are given in Section 2. In Section 3 two conditions for local stability of limit cycles are compared. The main result on multiple fast switches is given in Section 4. Some analyses of generic systems to gain extra insight are done in Section 5. Section 6 presents systems of various pole excesses that exhibit limit cycles with fast switches.

2. Preliminaries

Consider a relay feedback system that consists of a linear system G and a relay defined as follows. The system G is a strictly proper transfer function with scalar input u and scalar output y . Let a minimal state-

space representation of G be given by

$$\begin{aligned}\dot{x} &= Ax + Bu, \\ y &= Cx,\end{aligned}\tag{1}$$

where $x = (x_1, \dots, x_n)^T \in \mathbf{R}^n$. The relay feedback is defined by

$$u = -\operatorname{sgn} y = \begin{cases} -1, & \text{if } y > 0, \\ 1, & \text{if } y < 0, \end{cases}\tag{2}$$

so the relay does not have hysteresis. The *switch plane* \mathcal{S} is the hyperplane of dimension $n - 1$ where the output vanishes, that is,

$$\mathcal{S} := \{x : Cx = 0\}.$$

On either side of \mathcal{S} the feedback system is linear: if $Cx > 0$ the dynamics are given by $\dot{x} = Ax - B$, and if $Cx < 0$ we have $\dot{x} = Ax + B$. We also introduce the notation

$$\mathcal{S}_+ := \{x \in \mathcal{S} : CAx - CB > 0\}.$$

Because the linear dynamics on each side of \mathcal{S} have fixed points equal to $\pm A^{-1}B$ (if A is nonsingular), positive steady-state gain guarantees the trajectories not to tend to any of these two fixed points, and thus ensures a relay switch to occur.

The differential equation (1)–(2) is only applicable for $x \notin \mathcal{S}$. By letting $u \in [-1, 1]$ for $x \in \mathcal{S}$, the solution can still be a continuous function which satisfies (1)–(2) everywhere, for further discussion see [Yakubovich, 1973] and [Filippov, 1988].

Intuitively, it seems reasonable to approximate a relay by a saturation with steep slope. This is done in [Tsytkin, 1984]. There are, however, subtleties when taking the limit as the slope tends to infinity. If this limit is not dealt with properly, erroneous results may be derived. An illustration is given when discussing Balasubramanian's stability condition in Section 3.

Let the Poincaré map $g = g(x) : \mathcal{S}_+ \rightarrow \mathcal{S}_+$ be the map from one switch plane intersection x to next switch plane intersection z reflected in the origin, so that $g(x) = -z$. If A is non-singular, we have

$$g(x) = -e^{Ah(x)}x + (e^{Ah(x)} - I)A^{-1}B,\tag{3}$$

where $h(x)$ is the *switch time*, that is, the unique time it takes to go between the consecutive intersections x and $-g(x)$. Recall that the first

non-vanishing Markov parameter $CA^k B$ determines the pole excess (relative degree) of G . For example, $CB = 0$ if and only if the pole excess of G is greater than one.

Let $\phi(t, x_0)$ denote a trajectory of (1)–(2) starting in x_0 . A *closed orbit* is a trajectory such that $\phi(t_1, x_0) = \phi(t_2, x_0)$ for some $t_1 < t_2$. A point p is a *limit point* of the trajectory if there exists a sequence $\{t_k\}$, with $t_k \rightarrow \infty$ as $k \rightarrow \infty$, such that $\phi(t_k, x_0) \rightarrow p$ as $k \rightarrow \infty$. The set of all limit points is the *limit set* of the trajectory and is denoted L . A limit set that is a closed orbit is a *limit cycle*. The limit cycle is *simple* if it has exactly two intersections with the switch plane S . It is *symmetric* if $x \in L$ implies that $-x \in L$. The limit cycle is called globally attractive if it is the limit set of all possible trajectories.

The main results are in the following stated as theorems. A result known from the literature or of less importance is stated as a proposition.

3. Stability of Limit Cycles

An important behavior of relay feedback systems is that they often tend to a stable oscillation. In this section a necessary and sufficient condition is given for local stability of a limit cycle. The condition was derived in [Åström and Hägglund, 1984a; Åström, 1995] and is here compared to a similar result in the literature.

An obvious question is whether it exists relay feedback systems that do not have a unique stable limit cycle. For higher-order systems it does, as shown by the following example.

EXAMPLE 1

Let

$$G(s) = \frac{(s+1)^2}{(s+0.1)^3(s+7)^2}.$$

Depending on the initial conditions, the relay feedback system tends to either a slow or a fast limit cycle. In Figure 1 the relay output u is shown for the two cases after the initial transient has disappeared. Analysis shows that the limit cycles are locally stable, see Example 3. \square

A describing function analysis [Atherton, 1975] gives in this case the correct qualitative result.

If $\phi^*(t, x_0)$ is part of a stable simple limit cycle, and thus $\phi^*(t, x_0) \in L$ for all $t \geq 0$, then the intersections with S equals $\pm x^* \in L$, where x^* is a fixed point of g , that is, $x^* = g(x^*)$. Hence, solving the equation $x = g(x)$ gives candidates for simple limit cycle intersections with S_+ . If

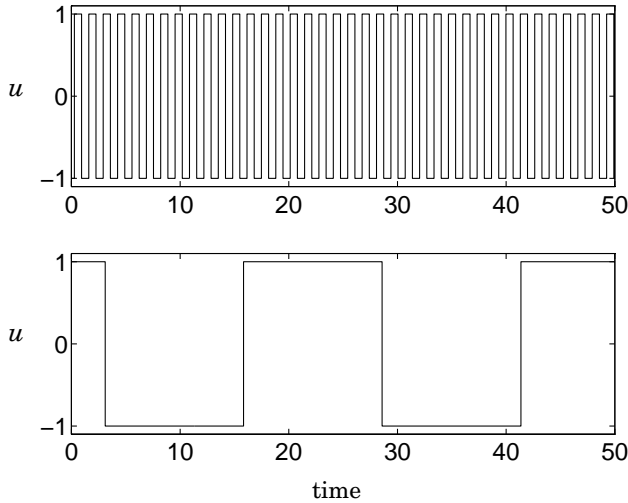

Figure 1. Two stable limit cycles for the system in Example 1.

A is nonsingular, the solution is given by

$$x = (e^{Ah(x)} + I)^{-1}(e^{Ah(x)} - I)A^{-1}B. \quad (4)$$

The following proposition is proved in [Åström and Hägglund, 1984a; Åström, 1995] by the classical approach of studying small perturbations of the Poincaré map g .

PROPOSITION 1

Consider the relay feedback system (1)–(2) with nonsingular A . If there exists a simple limit cycle with period $2h^*$, then

$$f(h^*) := C(e^{Ah^*} + I)^{-1}(e^{Ah^*} - I)A^{-1}B = 0. \quad (5)$$

The limit cycle is stable if and only if all eigenvalues of

$$W_a := \left(I - \frac{wC}{Cw} \right) e^{Ah^*}, \quad w = 2(e^{Ah^*} + I)^{-1}e^{Ah^*}B \quad (6)$$

are in the open unit disc. □

Note that $f(0) = 0$, so the trivial solution $h^* = 0$ always satisfies the necessary condition (5). It is easy to show that this is the only solution for first-order systems and for second-order systems with no zeros. Hence, these systems exhibit no simple limit cycles under relay feedback.

Stability of limit cycles is also studied in [Balasubramanian, 1981]. The relay feedback system is rewritten as a periodically time-varying linear system, which gives the following result.

PROPOSITION 2

Consider the relay feedback system (1)–(2) with $CB = 0$. If there exists a simple limit cycle with period $2h^*$, then the limit cycle is stable if and only if one eigenvalue of

$$W_b := \exp\left(-\frac{2BC}{Cw}\right) \exp(Ah^*), \quad w = 2(e^{Ah^*} + I)^{-1}e^{Ah^*}B$$

is on the unit circle and the others are in the open unit disc. □

From (4) it follows that $Cw = CAx^* + CB$, where $x^* \in S_+$ corresponds to the switch plane intersections of the limit cycle. If $CB \neq 0$, the output y possesses a discontinuity at the relay switches. It was suggested in [Balasubramanian, 1981] that a similar result to Proposition 2 holds for $CB \neq 0$, if W_b is replaced by

$$\widehat{W}_b = \exp\left(BC[(Ce^{-Ah^*}w)^{-1} - (Cw)^{-1}]\right) \exp(Ah^*),$$

compare [Wadey and Atherton, 1986] and [Atherton, 1993]. Note that w is the velocity immediately prior to the switch. The expression for \widehat{W}_b is obtained simply by replacing $(Cw)^{-1}$ by the harmonic mean immediately before and after the switches. This is, however, not correct as illustrated by the following example.

EXAMPLE 2

Consider the system

$$G(s) = \frac{\beta s + 1}{(s + 1)(s + 2)}$$

with state-space representation

$$\begin{aligned} \dot{x} &= \begin{pmatrix} 0 & -2 \\ 1 & -3 \end{pmatrix} x + \begin{pmatrix} 1 \\ \beta \end{pmatrix} u, \\ y &= \begin{pmatrix} 0 & 1 \end{pmatrix} x, \end{aligned}$$

and relay feedback. Let $\beta = -1$. The equation (5) has only one positive solution $h^* = 1.76$. The eigenvalues of W_a are 0 and -0.03 for h^* , so a locally stable limit cycle is predicted. In contrast, the eigenvalues of

\widehat{W}_b are -0.02 and -31.38 . It is possible to show that the system has a globally attractive limit cycle, for example, see [Holmberg, 1991]. Hence, \widehat{W}_b erroneously predicts a locally unstable limit cycle. \square

Next, we show that Propositions 1 and 2 are equivalent if $CB = 0$. First, note that if $CB = 0$, then

$$\exp\left(-\frac{2BC}{Cw}\right) = \sum_{k=0}^{\infty} \frac{(-2)^k}{k!(Cw)^k} (BC)^k = I - \frac{2BC}{Cw},$$

so that

$$W_b = \left(I - \frac{2BC}{Cw}\right) e^{Ah^*}. \quad (7)$$

PROPOSITION 3

Consider W_a and W_b as previously defined and assume $CB = 0$. Then, W_a has one eigenvalue equal to 0 and W_b has one eigenvalue equal to -1 . Furthermore, $\lambda \notin \{-1, 0\}$ is an eigenvalue of W_a if and only if λ is also an eigenvalue of W_b .

Proof: Combining (6) and (7), straightforward calculations give

$$W_b = W_a - e^{-Ah^*} \frac{wC}{Cw} e^{Ah^*}.$$

From the equalities

$$\begin{aligned} W_a e^{-Ah^*} w &= 0, \\ (W_b + I) e^{-Ah^*} w &= 0, \end{aligned} \quad (8)$$

it follows that $e^{-Ah^*} w$ is an eigenvector of W_a corresponding to the eigenvalue 0 and an eigenvector of W_b corresponding to the eigenvalue -1 .

Assume v is a left eigenvector of W_a corresponding to an eigenvalue $\lambda \neq 0$. Then,

$$\begin{aligned} v^T W_b &= v^T W_a - v^T e^{-Ah^*} \frac{wC}{Cw} e^{Ah^*} \\ &= v^T W_a - \lambda^{-1} v^T W_a e^{-Ah^*} \frac{wC}{Cw} e^{Ah^*} \\ &= v^T W_a, \end{aligned}$$

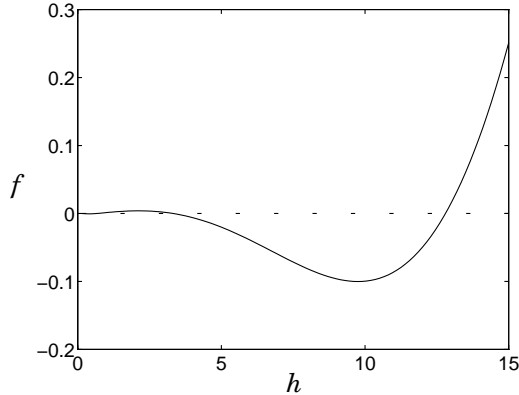

Figure 2. The solutions of the equation $f(h) = 0$, given in (5), yield possible limit cycle periods. For the system in Example 3 there exist four solutions (including $h = 0$).

where the last equality follows from (8). Hence, $v^T W_b = \lambda v^T$, so λ is also an eigenvalue of W_b . Next, assume instead v is a left eigenvector of W_b corresponding to an eigenvalue $\lambda \neq -1$. Then, similar to above,

$$\begin{aligned} v^T W_a &= v^T W_b + v^T e^{-Ah^*} \frac{wC}{Cw} e^{Ah^*} \\ &= v^T W_b + (\lambda + 1)^{-1} v^T (W_b + I) e^{-Ah^*} \frac{wC}{Cw} e^{Ah^*} \\ &= v^T W_b \\ &= \lambda v^T \end{aligned}$$

and the proof is complete. \square

Proposition 3 thus show that if $CB = 0$, the stability criteria in Proposition 1 and Proposition 2 are equivalent. Note, however, that Proposition 1 is valid even if $CB \neq 0$.

EXAMPLE 3

Consider the relay feedback system in Example 1. Figure 2 shows the function f in (5) as a function of h . The zero-crossings are at 0, 0.66, 3.32, and 12.80, so these are candidates for limit cycle periods. The eigenvalues with maximum magnitude of W_a and W_b (excluding the eigenvalue in -1 of W_b) for the four cases are 1, 0.60, 1.42, and 0.64, respectively. Only the second and the fourth zero-crossings thus come from a locally stable limit cycle. Note that we cannot draw any conclusions about convergence. \square

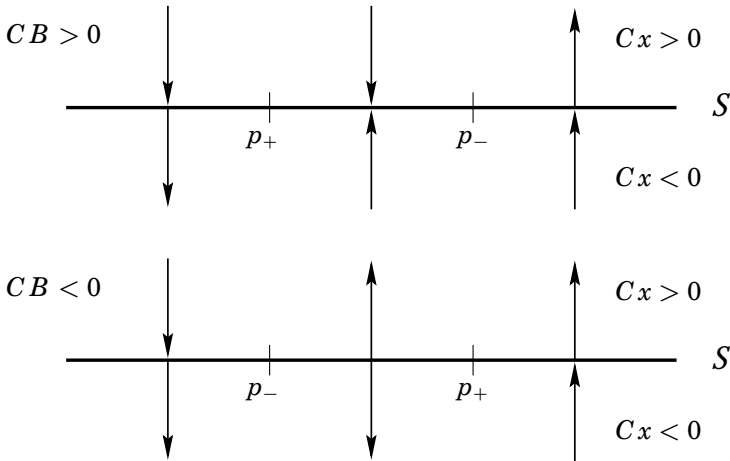

Figure 3. Switch plane S and trajectories close to S for second-order system with $CB \neq 0$. The points p_+ and p_- indicate where the trajectories change directions. There exist first-order sliding modes if and only if $CB > 0$.

4. Existence of Fast Switches

A necessary and sufficient condition for the existence of multiple fast relay switches is proved in this section. There are interesting similarities to the condition for sliding modes. We start by recalling a well-known result.

If the vector fields on both side of the switch plane are pointing towards the plane, the trajectories will be driven to the plane and then slide along it. This sliding behavior is called a regular or a first-order sliding mode and is treated thoroughly in [Filippov, 1988]. See [Fridman and Levant, 1996] for a definition of higher-order sliding modes. The existence of first-order sliding modes in linear systems with relay feedback can simply be determined from studying $\dot{y} = CAx \pm CB$ close to S . We see that depending on the value of CB , a classification of the directions of the trajectories divide the switch plane into two or three regions. Sliding modes exist if there is a region in S , such that the vector fields on both sides are pointing towards S . We illustrate with a second-order example.

EXAMPLE 4

Consider the same system as in Example 2, that is,

$$G(s) = \frac{\beta s + 1}{(s + 1)(s + 2)}$$

with state-space representation

$$\begin{aligned}\dot{x} &= \begin{pmatrix} 0 & -2 \\ 1 & -3 \end{pmatrix} x + \begin{pmatrix} 1 \\ \beta \end{pmatrix} u, \\ y &= \begin{pmatrix} 0 & 1 \end{pmatrix} x,\end{aligned}$$

and relay feedback. Then \mathcal{S} equals the x_1 -axis, see Figure 3. Let p_+ and p_- be the solutions of the equations

$$CAx + CB = 0, \quad CAx - CB = 0,$$

respectively. These are the points where the trajectories change directions, and they are given by $p_+ = (-\beta, 0)$ and $p_- = (\beta, 0)$. For $CB = \beta > 0$ there exist sliding modes, whereas for $CB < 0$ the region between p_+ and p_- is repelling. The region vanishes if $CB = 0$. \square

The condition in the example for existence of sliding modes directly generalizes to systems of order $n > 2$. Then p_+ and p_- denote hyperplanes of dimension $n - 2$, which still divide the switch plane into two or three regions. The following well-known result is for example pointed out on page 436 in [Tsyppkin, 1984], see also [Filippov, 1988].

PROPOSITION 4

Consider the relay feedback system (1)–(2) with order $n \geq 2$. There exist first-order sliding modes if and only if $CB > 0$. \square

If $CB < 0$ we can conclude that there exist no arbitrarily fast relay switches.

Next, we consider systems with $CB = 0$. Figure 4 shows trajectories close to $\{x \in \mathcal{S} : CAx = 0\}$ for a third-order system with $CAB > 0$ and $CAB < 0$. The tick marks indicate

$$CA^2\chi_- - CAB = 0, \quad CA^2\chi_+ + CAB = 0,$$

that is, the points x on the line $\{x \in \mathcal{S} : CAx = 0\}$ such that $\ddot{y} = 0$. Solid trajectories are above the switch plane ($Cx > 0$) and dashed under ($Cx < 0$). The figure suggests that consecutive switch times $h(\cdot)$ can be arbitrarily short if and only if $CAB > 0$. A proof will be given next that for systems of arbitrary order to have multiple fast switches, it is necessary and sufficient for the first non-vanishing Markov parameter to be positive.

THEOREM 1

Consider the relay feedback system (1)–(2) with order $n \geq 3$. Define $k \in \{1, \dots, n - 2\}$ such that $CA^\ell B = 0$ for $\ell = 0, \dots, k - 1$ and $CA^k B \neq 0$. Then, there exists a bounded sequence $\{x_m\}_{m=1}^\infty$ with $x_m \in \mathcal{S}_+$ such that $h(x_m) + h(g(x_m)) \rightarrow 0$ as $m \rightarrow \infty$ if and only if $CA^k B > 0$.

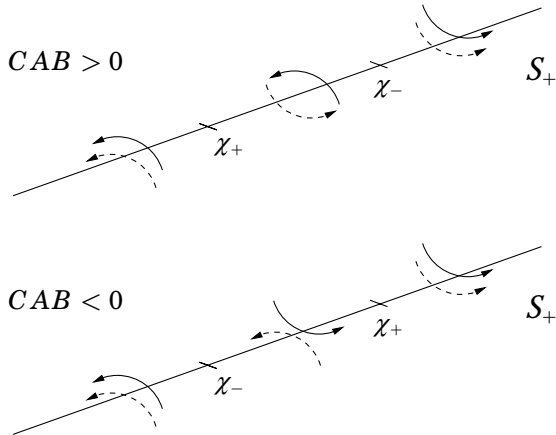

Figure 4. The sign of the first non-vanishing Markov parameter determines the existence of multiple fast switches. Here the trajectories close to the second-order sliding set $\{x \in S : CAx = 0\}$ for a third-order system with $CB = 0$ are shown. We have $Cx > 0$ above the switch plane and $CAx > 0$ to the right of the line. Multiple fast relay switches occur if and only if $CAB > 0$.

Proof: Let $\phi_-(t, x)$, $t > 0$, denote the trajectory of $\dot{x} = Ax - B$ starting in x at time $t = 0$. For $x \in S_+$, Taylor expansion gives

$$\begin{aligned}
 C\phi_-(t, x) &= CAxt + \cdots + CA^k x \frac{t^k}{k!} \\
 &+ (CA^{k+1}x - CA^k B) \frac{t^{k+1}}{(k+1)!} + O(t^{k+2}).
 \end{aligned} \tag{9}$$

Sufficiency: Assume $CA^k B > 0$. Then,

$$C\phi_-(t_0, 0) = -CA^k B \frac{t_0^{k+1}}{(k+1)!} + O(t_0^{k+2}) < 0,$$

for $t_0 > 0$ sufficiently small. For a fixed such t_0 , we have $C\phi_-(t_0, \tilde{x}) < 0$ for all $\tilde{x} \in S_+$ with $|\tilde{x}|$ sufficiently small. Consider a fixed such \tilde{x} . Then, there exists a small $t \in (0, t_0)$ such that $C\phi_-(t, x) > 0$, because $CA\tilde{x} > 0$. In between t and t_0 a switch thus occurs. Hence, we have that $h(x) \rightarrow 0$ as $x \rightarrow 0$ in S_+ and therefore also $g(x) \rightarrow 0$. The same type of argument gives that $h(g(x)) \rightarrow 0$.

Necessity: Assume there exists a bounded sequence $\{x_m\}_{m=1}^\infty$, $x_m \in S_+$, such that $h(x_m) + h(g(x_m)) \rightarrow 0$ as $m \rightarrow \infty$. After replacing $\{x_m\}_{m=1}^\infty$

with a suitable subsequence, we can assume that there exists $\hat{x} \in S$ with $CA\hat{x} = 0$ such that $x_m \rightarrow \hat{x}$. It is obvious that $g(x_m) \rightarrow -\hat{x}$. Now, assume $CA^2\hat{x} > 0$. Then, there exists $t_1 > 0$ such that

$$C\phi_-(t, \hat{x}) = CA^2\hat{x}\frac{t^2}{2} + O(t^3) > 0,$$

for $t \in (0, t_1)$. Hence, $C\phi_-(t, x_m) > 0$ for all $t \in (0, t_1)$ and m sufficiently large. However, this contradicts that $h(x_m) \rightarrow 0$ as $m \rightarrow \infty$ and $C\phi_-(h(x_m), x_m) = 0$. Hence, $CA^2\hat{x} \leq 0$. A similar argument for $g(x_m)$ gives $CA^2\hat{x} \geq 0$, so we have $CA^2\hat{x} = 0$. In the same way, $CA^\ell\hat{x} = 0$ for every $\ell \in \{1, \dots, k\}$. The same type of argument applied to term $k + 1$ in (9) gives

$$CA^{k+1}\hat{x} - CA^k B \leq 0, \quad CA^{k+1}g(\hat{x}) - CA^k B \leq 0,$$

or equivalently

$$CA^{k+1}\hat{x} \leq CA^k B, \quad -CA^{k+1}\hat{x} \leq CA^k B.$$

Hence, $CA^k B \geq 0$ and the result follows. \square

REMARK 1 It follows from the proof that multiple fast switches only occur close to $\{x \in S : CA^\ell x = 0, \ell = 1, \dots, k\}$ in the region $|CA^{k+1}x| < CA^k B$.

The following example illustrates multiple fast switches in a third-order system.

EXAMPLE 5

Consider the system

$$G(s) = \frac{\zeta - s}{\zeta(s+1)^3}$$

with state-space representation

$$\begin{aligned} \dot{x} &= \begin{pmatrix} -3 & 1 & 0 \\ -3 & 0 & 1 \\ -1 & 0 & 0 \end{pmatrix} x + \begin{pmatrix} 0 \\ -1/\zeta \\ 1 \end{pmatrix} u, \\ y &= \begin{pmatrix} 1 & 0 & 0 \end{pmatrix} x, \end{aligned}$$

and relay feedback. Figure 5 shows two trajectories starting close to the origin for $\zeta = -4$ and $\zeta = 1$, respectively. As predicted by Theorem 1, multiple fast switches occur when $CAB = -1/\zeta > 0$ but not when $CAB < 0$. Compare Figure 4 and Figure 5.

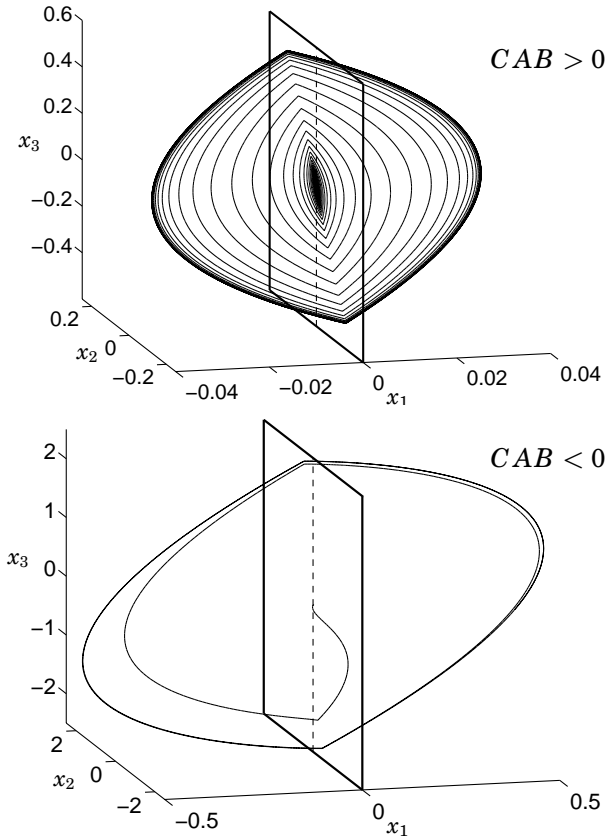

Figure 5. Clockwise trajectories with initial conditions close to the origin for the third-order system in Example 5. Multiple fast switches exist if $CB = 0$ and $CAB > 0$ ($\zeta < 0$). The system performs a large number of fast switches with slowly growing amplitude. If $CB = 0$ and $CAB < 0$ ($\zeta > 0$) there are no fast oscillations. Both trajectories converge to a limit cycle.

The trajectories tend to a limit cycle for both systems. Figure 6 shows the limit cycle period $2h$ as a function of the zero ζ . The dashed line corresponds to the limit cycle for the system $1/(s+1)^3$. The relay feedback system is stable for $\zeta \in (-3, 0)$. Local analysis around the limit cycle, as described in Section 3, gives in agreement with Figure 5 that the convergence is faster if $\zeta = -4$ than if $\zeta = 1$. Note, however, that the results in Theorem 1 are independent of the existence of limit cycles. \square

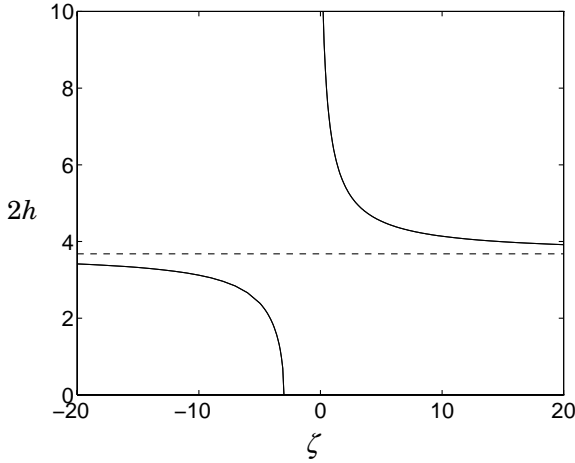

Figure 6. The limit cycle period as a function of zero location in Example 5.

5. Nature of Fast Switches

Having established that the sign of the first non-vanishing Markov parameter determines if there will be fast switches, we will now investigate the nature of the fast switches in more detail. It turns out that the behavior is given by the pole excess and a number of the first non-vanishing Markov parameters. It was already mentioned that there will be a first-order sliding mode if the pole excess is one and $CB > 0$. In this section, we study the nature of fast switches for systems with pole excess two, pole excess three, and higher-order pole excess.

Pole excess two—many fast switches

There exist initial conditions that give a large number of fast switches if $CB = 0$ and $CAB > 0$. The generic case is represented by the double integrator

$$\begin{aligned} \dot{x} &= \begin{pmatrix} 0 & 1 \\ 0 & 0 \end{pmatrix} x + \begin{pmatrix} 0 \\ 1 \end{pmatrix} u, \\ y &= \begin{pmatrix} 1 & 0 \end{pmatrix} x. \end{aligned}$$

Assume the trajectory of this system with relay feedback passes the switch plane at time $t = 0$ at

$$x(0) = \begin{pmatrix} 0 & x_{20} \end{pmatrix}^T, \quad x_{20} > 0.$$

Then, until next switch

$$\begin{aligned}x_1(t) &= x_{20}t - \frac{t^2}{2}, \\x_2(t) &= x_{20} - t.\end{aligned}$$

The first equation gives that the first switch occurs at $h_1 = 2x_{20}$. Between the first and the second switch we have

$$\begin{aligned}x_1(h_1 + t) &= x_{20}t - h_1t + \frac{t^2}{2}, \\x_2(h_1 + t) &= x_{20} - h_1 + t,\end{aligned}$$

so the second switch time is $h_2 = 2(h_1 - x_{20}) = 2x_{20}$. Hence, $h_k = 2x_{20}$ for all $k > 0$, so a double integrator with relay feedback has a limit cycle with any period.

Next, consider the system

$$G(s) = \frac{K}{s(s+a)}, \quad K > 0,$$

and let the relay be approximated with a steep slope. Then, a root-locus argument predicts fast oscillations with increasing amplitude if $a < 0$ and fast oscillations with decreasing amplitude if $a > 0$. The double integrator with a neutral stable oscillation corresponds to $a = 0$.

A higher-order system with zeros $\{z_i\}$, poles $\{p_i\}$, and pole excess two can be written as

$$G(s) = K \frac{\prod_{i=1}^{n-2} (s - z_i)}{\prod_{i=1}^n (s - p_i)} = K \frac{\prod_{i=1}^{n-2} (1 - z_i/s)}{s^2 \prod_{i=1}^n (1 - p_i/s)}.$$

A series expansion in $1/s$ gives the terms that dominate the behavior of the system for high frequencies. Hence,

$$G(s) \approx \frac{K}{s(s+a)}, \tag{10}$$

where

$$a = \sum_{i=1}^{n-2} z_i - \sum_{i=1}^n p_i.$$

The behavior of the system is thus governed by the sign of the parameter $a = CA^2B/K$. The oscillations are unstable for $a < 0$, neutral for $a = 0$, and damped for $a > 0$. We illustrate with a simulation.

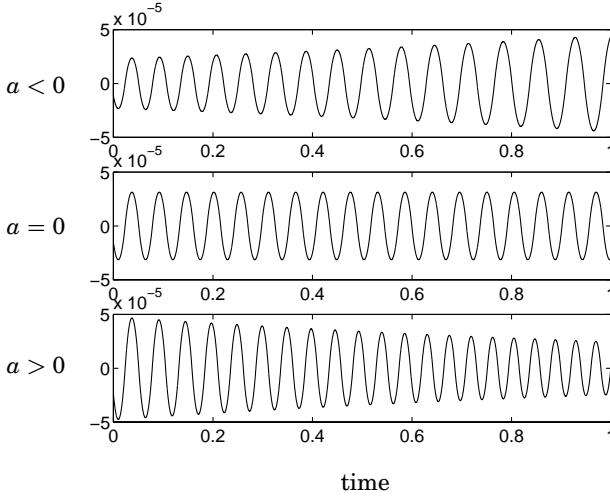

Figure 7. Fast oscillations for systems with pole excess two. The oscillations are unstable, neutral, or damped, depending on the parameter a in (10).

EXAMPLE 6

Consider the system in Example 5:

$$G(s) = \frac{\zeta - s}{\zeta(s + 1)^3}.$$

Here, $a = \zeta + 3$. Figure 7 shows the output y for $a = -1, 0, 1$ and initial condition $x(0)$ close to the origin. □

Pole excess three—few fast switches

Systems of pole excess higher than two cannot have fast oscillations as the ones shown in Figure 7. A triple integrator represents the fast behavior in systems of pole excess three. Therefore, consider the system

$$\begin{aligned} \dot{x} &= \begin{pmatrix} 0 & 1 & 0 \\ 0 & 0 & 1 \\ 0 & 0 & 0 \end{pmatrix} x + \begin{pmatrix} 0 \\ 0 \\ 1 \end{pmatrix} u, \\ y &= \begin{pmatrix} 1 & 0 & 0 \end{pmatrix} x, \end{aligned}$$

with relay feedback. Assume the trajectory of the system passes the switch plane at time $t = 0$ at

$$x(0) = \begin{pmatrix} 0 & x_{20} & x_{30} \end{pmatrix}^T, \quad x_{20} > 0.$$

Then, until next switch

$$\begin{aligned}x_1(t) &= x_{20}t + x_{30}\frac{t^2}{2} - \frac{t^3}{6}, \\x_2(t) &= x_{20} + x_{30}t - \frac{t^2}{2}, \\x_3(t) &= x_{30} - t.\end{aligned}$$

Because $x_1(h_1) = 0$, the first switch time fulfills the equation

$$h_1^2 - 3x_{30}h_1 - 6x_{20} = 0.$$

Continued evaluation of the state-space system gives at the second switch instant, where $x_1(h_1 + h_2) = 0$, that

$$h_2^2 + 3(x_{30} - h_1)h_2 + 6x_{20} + 6x_{30}h_1 - 3h_1^2 = 0.$$

By solving for x_{20} and x_{30} in these two equations, we get

$$\begin{aligned}x_{20} &= h_1 \frac{h_2^2 - h_1^2 - 2h_1h_2}{6(h_1 + h_2)}, \\x_{30} &= \frac{2h_1^2 - h_2^2 + 3h_1h_2}{3(h_1 + h_2)}.\end{aligned}$$

Because $x_{20} > 0$, we have $h_2^2 - h_1^2 - 2h_1h_2 > 0$ and thus $h_2 > (1 + \sqrt{2})h_1$. Repeated evaluation yields

$$h_k > (1 + \sqrt{2})^{k-1}h_1.$$

This estimate gets tighter as the initial state approaches the origin. We can conclude that there is a substantial increase in switch time after each iteration for a triple integrator.

Higher-order systems with pole excess three can be analyzed via a series expansion similar to the one in previous section. At high frequencies, these systems respond as a triple integrator. In particular,

$$G(s) \approx \frac{K}{s^2(s + a)}, \quad K > 0.$$

From a root-locus argument, we see that any fast behavior is unstable regardless of the sign of a .

Higher-order pole excess—fewer fast switches

The increase in switch time is even higher for systems with pole excess larger than three. Consider an integrator of order n

$$\dot{x} = \begin{pmatrix} 0 & 1 & 0 & \dots & 0 \\ 0 & 0 & 1 & & 0 \\ \vdots & & & \ddots & \vdots \\ 0 & 0 & 0 & & 1 \\ 0 & 0 & 0 & \dots & 0 \end{pmatrix} x + \begin{pmatrix} 0 \\ 0 \\ \vdots \\ 0 \\ 1 \end{pmatrix} u,$$

$$y = \begin{pmatrix} 1 & 0 & 0 & \dots & 0 \end{pmatrix} x,$$

and introduce the partitioned matrices

$$\left(\begin{array}{c|c} 1 & \alpha(t) \\ \hline 0 & V(t) \end{array} \right) := e^{At} = \begin{pmatrix} 1 & t & \frac{1}{2}t^2 & \dots & \frac{1}{(n-1)!}t^{n-1} \\ 0 & 1 & t & \dots & \frac{1}{(n-2)!}t^{n-2} \\ \vdots & & & \ddots & \vdots \\ 0 & 0 & 0 & & t \\ 0 & 0 & 0 & \dots & 1 \end{pmatrix}$$

and

$$\left(\begin{array}{c} \beta(t) \\ \gamma(t) \end{array} \right) := \int_0^t e^{A\tau} B d\tau = \begin{pmatrix} \frac{1}{n!}t^n \\ \frac{1}{(n-1)!}t^{n-1} \\ \vdots \\ \frac{1}{2}t^2 \\ t \end{pmatrix}.$$

Let the initial state

$$x(0) = \begin{pmatrix} 0 \\ \xi^0 \end{pmatrix}$$

lie on the switch plane and assume $\xi_1^0 > 0$, so that the trajectory passes through S_+ . Then, we have

$$x(t) = \begin{pmatrix} \alpha(t)\xi^0 - \beta(t) \\ V(t)\xi^0 - \gamma(t) \end{pmatrix}, \quad 0 < t < h_1,$$

where h_1 is the first switch time. Hence,

$$\begin{aligned} \alpha(h_1)\xi^0 &= \beta(h_1), \\ \xi^1 &= V(h_1)\xi^0 - \gamma(h_1). \end{aligned} \tag{11}$$

Furthermore, for the second switch time h_2 ,

$$\begin{aligned}\alpha(h_2)\xi^1 &= -\beta(h_2), \\ \xi^2 &= V(h_2)\xi^1 + \gamma(h_2),\end{aligned}$$

so that

$$\alpha(h_2)V(h_1)\xi^0 = \alpha(h_2)\gamma(h_1) - \beta(h_2). \quad (12)$$

Continued evaluation gives

$$\begin{aligned}\alpha(h_k)V(h_{k-1}) \cdots V(h_1)\xi^0 \\ &= \alpha(h_k)V(h_{k-1}) \cdots V(h_2)\gamma(h_1) - \alpha(h_k)V(h_{k-2}) \cdots V(h_3)\gamma(h_2) + \dots \\ &\quad - (-1)^k \alpha(h_k)V(h_{k-1})\gamma(h_{k-2}) + (-1)^k \alpha(h_k)\gamma(h_{k-1}) - (-1)^k \beta(h_k).\end{aligned}$$

Stacking $n-1$ of these equations yields a linear equation in ξ^0 . An analysis similar to the preceding for the triple integrator is therefore possible. It results in lower bounds on the switch times h_k . The analysis is particular simple if we assume the initial condition $\xi^0 = (\xi_1^0, 0, \dots, 0)$. Then, (11) gives $h_1 \xi_1^0 = h_1^n / n!$ or

$$h_1 = n! \sqrt[n]{\xi_1^0}.$$

Hence, for small initial states, the switch time increases considerably with the number of integrators n . Furthermore, (12) gives after some calculations

$$\left(1 + \frac{h_1}{h_2}\right)^n = 2 + \left(\frac{h_1}{h_2}\right)^{n-1} + \left(\frac{h_1}{h_2}\right)^n.$$

Therefore, for h_1 much smaller than h_2 , we have the formula

$$h_2 \approx (\sqrt[n]{2} - 1)^{-1} h_1.$$

Analysis that gives similar results can be done assuming other initial states ξ^0 .

The fast behavior in systems with pole excess greater than or equal to three is thus unstable. The number of fast switches following a given initial state decrease with increasing pole excess.

Summary

The pole excess is important to characterize the solutions in relay feedback systems. With pole excess one there can be first-order sliding modes. For the system $1/s^2$ there will be limit cycles of arbitrary period. The limit

cycles are not asymptotically stable. For systems of higher order with pole excess two, the behavior can be understood from a series expansion. In a similar way, the fast switches in any system of pole excess $k > 0$ can be analyzed by studying an integrator of order k . There is, however, a particular difference between consecutive fast switches for systems with pole excess two and systems with pole excess three or higher.

Note that the dimension of the subspace that the trajectories approach decreases with increasing pole excess: a first-order sliding mode takes place in a hyperplane of dimension $n - 1$, the fast oscillation for system with pole excess two approaches a hyperplane of dimension $n - 2$ etc. These hyperplanes correspond to the sliding sets defined in [Fridman and Levant, 1996]. The first-order sliding set is equal to \mathcal{S} , the second-order sliding set is equal to $\{x \in \mathcal{S} : CAx = 0\}$, the third-order sliding set is equal to $\{x \in \mathcal{S} : CAx = CA^2x = 0\}$ etc. Only systems with pole excess one and two can have stable sliding sets in the sense that a trajectory tends to the corresponding sliding set.

6. Fast Switches in Limit Cycles

Sliding modes and fast switches can be part of a stable limit cycle. A necessary condition for this is that the assumptions in Proposition 4 or Theorem 1 hold, that is, that the first non-vanishing Markov parameter is positive. We show next how the various fast oscillations discussed in the previous sections can be part of limit cycles. It is the pole excess of the system that determines the kind of fast behavior the limit cycle will contain.

Pole excess one—limit cycles with first-order sliding modes

Consider a relay feedback system (1)–(2) with $CB > 0$. Proposition 4 gives that there exist first-order sliding modes. This sliding can be part of a stable limit cycle.

Suppose that the limit cycle consists of one smooth part and one sliding mode part. Furthermore, suppose that the smooth part starts at time $t = 0$ in $x^0 = x(0)$ with $CAx^0 = CB$. The trajectory of the system will then follow the dynamics $\dot{x} = Ax - B$. Assume that the trajectory hits the switch plane at $t = t_{\text{sm}}$ in $x^1 = x(t_{\text{sm}})$ with $|CAx^1| < CB$. A sliding mode \bar{x} can then be defined that describes the solution in \mathcal{S} . This is done by replacing u with

$$\bar{u} = -\frac{CA\bar{x}}{CB},$$

such that $C\dot{\bar{x}} = CA\bar{x} + CB\bar{u} = 0$, see [Utkin, 1987; Filippov, 1988]. The variable \bar{u} is called the equivalent control. The dynamics of the sliding

mode are given by

$$\dot{\bar{x}} = PA\bar{x}, \quad (13)$$

where

$$P := I - \frac{BC}{CB} \quad (14)$$

is a projection matrix fulfilling $CP = 0$ and $PB = 0$. Hence, the projection is such that $C\bar{x}(t) = 0$ until $CA\bar{x}(t) = -CB$. If the limit cycle is symmetric and simple, it leaves the switch plane at time $t_{\text{sm}} + t_{\text{sl}}$ at $x(t_{\text{sm}} + t_{\text{sl}}) = -x^0$. We have the following necessary condition for the described limit cycle.

PROPOSITION 5

Consider the relay feedback system (1)–(2) with $CB > 0$. If there exists a simple symmetric limit cycle with a first-order sliding mode and period time $2h^*$, then

$$\begin{aligned} f_1(t_{\text{sm}}, t_{\text{sl}}) &:= C(e^{At_{\text{sm}}}e^{PA t_{\text{sl}}} + I)^{-1}(e^{At_{\text{sm}}} - I)A^{-1}B = 0, \\ f_2(t_{\text{sm}}, t_{\text{sl}}) &:= CA(e^{PA t_{\text{sl}}}e^{At_{\text{sm}}} + I)^{-1}e^{PA t_{\text{sl}}}(e^{At_{\text{sm}}} - I)A^{-1}B + CB = 0, \end{aligned}$$

where $h^* = t_{\text{sm}} + t_{\text{sl}}$. Here, t_{sm} is the time for the smooth part of the trajectory, and t_{sl} is the sliding mode time.

Proof: Using the notation introduced above, we have that

$$\begin{aligned} x^1 &= e^{At_{\text{sm}}}x^0 - (e^{At_{\text{sm}}} - I)A^{-1}B, \\ -x^0 &= x(t_{\text{sm}} + t_{\text{sl}}) = e^{PA t_{\text{sl}}}x^1. \end{aligned}$$

Solving for x^1 gives

$$x^1 = (e^{At_{\text{sm}}}e^{PA t_{\text{sl}}} + I)^{-1}(e^{At_{\text{sm}}} - I)A^{-1}B, \quad (15)$$

so $f_1(t_{\text{sm}}, t_{\text{sl}}) = 0$ follows from $Cx^1 = 0$. Furthermore,

$$\begin{aligned} x^0 &= -e^{PA t_{\text{sl}}}(e^{At_{\text{sm}}}e^{PA t_{\text{sl}}} + I)^{-1}(e^{At_{\text{sm}}} - I)A^{-1}B \\ &= -(e^{PA t_{\text{sl}}}e^{At_{\text{sm}}} + I)^{-1}e^{PA t_{\text{sl}}}(e^{At_{\text{sm}}} - I)A^{-1}B, \end{aligned} \quad (16)$$

so $f_2(t_{\text{sm}}, t_{\text{sl}}) = 0$ follows from $CAx^0 = CB$. \square

REMARK 2 The points where a limit cycle hits and leaves the switch plane are given by (15) and (16), respectively.

REMARK 3 Using $Cx^0 = 0$ instead of $Cx^1 = 0$ in the proof, gives an equivalent condition. This follows because $Ce^{PA t_{sl}} = C$ and thus

$$Ce^{PA t_{sl}}(e^{At_{sm}}e^{PA t_{sl}} + I)^{-1} = C(e^{At_{sm}}e^{PA t_{sl}} + I)^{-1}.$$

The solutions of the equations $f_1(t_1, t_2) = 0$ and $f_2(t_1, t_2) = 0$ give candidates for switch times. This is illustrated in Example 7, compare Example 3 in Section 3.

To get some more insight, we adopt the state-space representation

$$\begin{aligned} \dot{x} &= \begin{pmatrix} -a_1 & 1 & 0 & \dots & 0 \\ -a_2 & 0 & 1 & & 0 \\ \vdots & & & \ddots & \vdots \\ -a_{n-1} & 0 & 0 & & 1 \\ -a_n & 0 & 0 & \dots & 0 \end{pmatrix} x + \begin{pmatrix} 1 \\ b_2 \\ \vdots \\ b_{n-1} \\ b_n \end{pmatrix} u, \\ y &= \begin{pmatrix} 1 & 0 & 0 & \dots & 0 \end{pmatrix} x, \end{aligned} \quad (17)$$

where we normalized such that $CB = 1 > 0$. Note that $Cx = x_1$ and that $x \in S$ implies $CAx = x_2$. Moreover,

$$PA = \begin{pmatrix} 0 & 0 & 0 & \dots & 0 \\ b_2 a_1 - a_2 & -b_2 & 1 & & 0 \\ \vdots & & & \ddots & \vdots \\ b_{n-1} a_1 - a_{n-1} & -b_{n-1} & 0 & & 1 \\ b_n a_1 - a_n & -b_n & 0 & \dots & 0 \end{pmatrix},$$

so the sliding dynamics

$$\dot{z} = \begin{pmatrix} -b_2 & 1 & \dots & 0 \\ \vdots & & & \vdots \\ -b_{n-1} & 0 & & 1 \\ -b_n & 0 & \dots & 0 \end{pmatrix} z, \quad z := \begin{pmatrix} \bar{x}_2 & \dots & \bar{x}_n \end{pmatrix}^T$$

are unstable if and only if the polynomial $b(s) = s^{n-1} + b_2 s^{n-2} + \dots + b_{n-1} s + b_n$ is unstable. The sliding time t_{sl} depends on the zeros of b . We have the following well-known result.

PROPOSITION 6

Consider the relay feedback system (1)–(2) with $CB > 0$. Its sliding mode defined by (13) is stable if and only if the zeros of (1) are in the left half-plane. \square

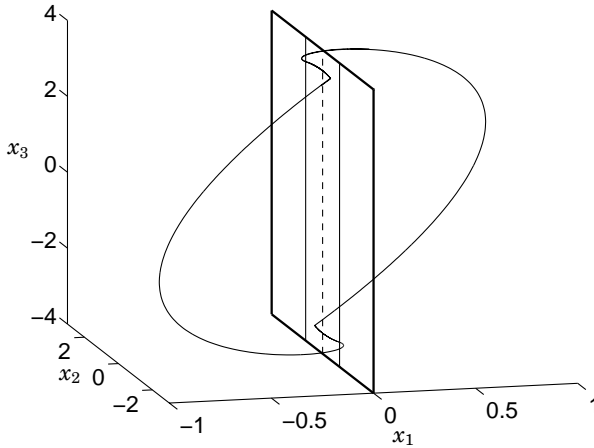

Figure 8. Clockwise limit cycle with sliding mode. The dashed line in the switch plane illustrates the line $\{x \in S : CAx = 0\}$ and the solid lines illustrate $\{x \in S : |CAx| = CB\}$. Note the points $\pm x^0$ and $\pm x^1$, where the limit cycle leaves and hits the switch plane, respectively.

EXAMPLE 7

Consider

$$G(s) = \frac{(s - \zeta)^2}{(s + 1)^3}, \quad \zeta > 0 \quad (18)$$

with state-space representation

$$\begin{aligned} \dot{x} &= \begin{pmatrix} -3 & 1 & 0 \\ -3 & 0 & 1 \\ -1 & 0 & 0 \end{pmatrix} x + \begin{pmatrix} 1 \\ -2\zeta \\ \zeta^2 \end{pmatrix} u, \\ y &= \begin{pmatrix} 1 & 0 & 0 \end{pmatrix} x. \end{aligned}$$

Then, $b(s) = (s - \zeta)^2$ has an unstable zero in ζ . Let $\zeta = 1$. The equations $f_1(t_{sm}, t_{sl}) = 0$ and $f_2(t_{sm}, t_{sl}) = 0$ in Proposition 5 have the solution $(t_{sm}, t_{sl}) = (4.04, 0.39)$. This corresponds to

$$x^0 = \begin{pmatrix} 0.00 \\ 1.00 \\ 3.35 \end{pmatrix}, \quad x^1 = \begin{pmatrix} 0.00 \\ 0.47 \\ -3.42 \end{pmatrix},$$

and agrees with the simulated (clockwise) limit cycle shown in Figure 8. The sliding dynamics are given by

$$\dot{z} = \begin{pmatrix} 2\zeta & 1 \\ -\zeta^2 & 0 \end{pmatrix} z.$$

For a sufficiently large ζ there will be no sliding modes. \square

Limit cycles with sliding modes are also reported in [Atherton *et al.*, 1985] and [Atherton, 1993]. Note that there exists no stable system of lower order than three that gives a limit cycle with a first-order sliding mode.

Pole excess two—limit cycles with many fast switches

Theorem 1 gives that systems with pole excess two have multiple fast switches if and only if $CAB > 0$. Next, it is shown that these systems may have a limit cycle, where part of the limit cycle is such a fast oscillation.

Let $CB = 0$ and $CAB > 0$. For small x_1 and x_2 , the states of the relay feedback system can be approximated by the averaged state variable \bar{x} . This is done through replacing u in the original equation by $\bar{u} = -CA^2\bar{x}/CAB$. Then,

$$\dot{\bar{x}} = \left(I - \frac{BCA}{CAB} \right) A\bar{x}.$$

Adopting the state-space representation (17) but with

$$B = \begin{pmatrix} 0 & 1 & b_3 & \dots & b_n \end{pmatrix}^T,$$

it is easy to see that this second-order sliding mode evolves in an $n - 2$ -dimensional subspace. It is close to this subspace the fast oscillations appear. The averaged dynamics are stable if the zeros of the linear system are stable. Furthermore, we have that the fast behavior can only persist as long as $|CA^2x| < CAB$ from Remark 1 of Theorem 1. Similar to the analysis of limit cycles with first-order sliding modes, the duration of the fast oscillations can be estimated. We illustrate with an example.

EXAMPLE 8
Consider

$$G(s) = \frac{(s - \zeta)^2}{(s + 1)^4}, \quad \zeta > 0$$

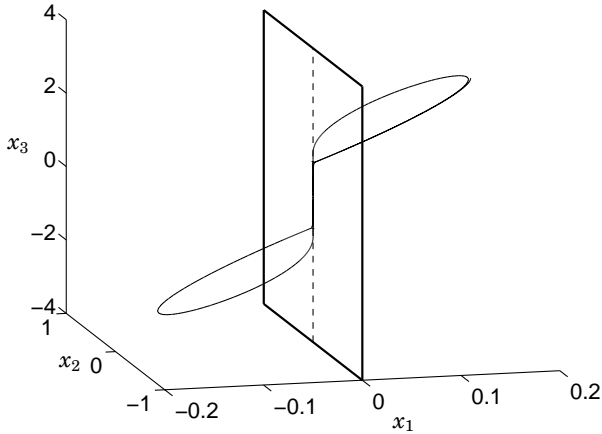

Figure 9. Limit cycle with fast oscillations for system with pole excess two. The two loops are clockwise. The dashed line in the switch plane illustrates the second-order sliding set $\{x \in S : CAx = 0\}$.

with state-space representation

$$\dot{x} = \begin{pmatrix} -4 & 1 & 0 & 0 \\ -6 & 0 & 1 & 0 \\ -4 & 0 & 0 & 1 \\ -1 & 0 & 0 & 0 \end{pmatrix} x + \begin{pmatrix} 0 \\ 1 \\ -2\zeta \\ \zeta^2 \end{pmatrix} u,$$

$$y = \begin{pmatrix} 1 & 0 & 0 & 0 \end{pmatrix} x.$$

Let $\zeta = 0.2$. Figure 9 shows the limit cycle in the subspace (x_1, x_2, x_3) . The averaging analysis above gives that the fast oscillations should be in the two-dimensional subspace (x_1, x_2) . This is illustrated in Figure 10, where the fast oscillations around the line $\{x \in S : CAx = 0\} = \{x : x_1 = x_2 = 0\}$ are magnified. Figure 11 shows the four states during the fast oscillations. In agreement with the preceding analysis, the oscillations start at $CA^2x = -CAB$ and end at $CA^2x = CAB$, that is, at $x_3 = -1$ and $x_3 = 1$, respectively. The state x_4 is approximately constant during the fast oscillations. \square

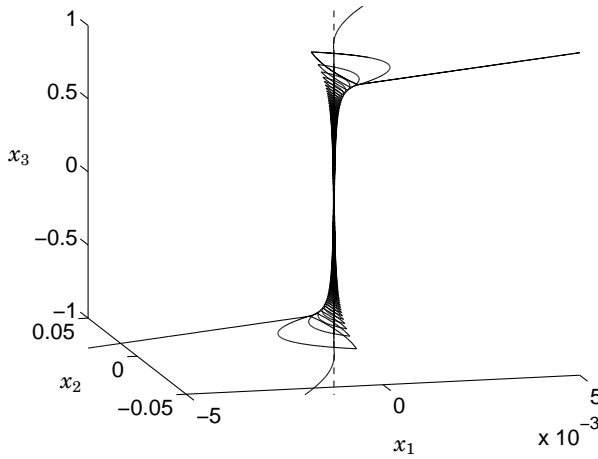

Figure 10. A closer look at the fast oscillations in the limit cycle. The dashed line is the second-order sliding set $\{x \in \mathcal{S} : CAx = 0\}$.

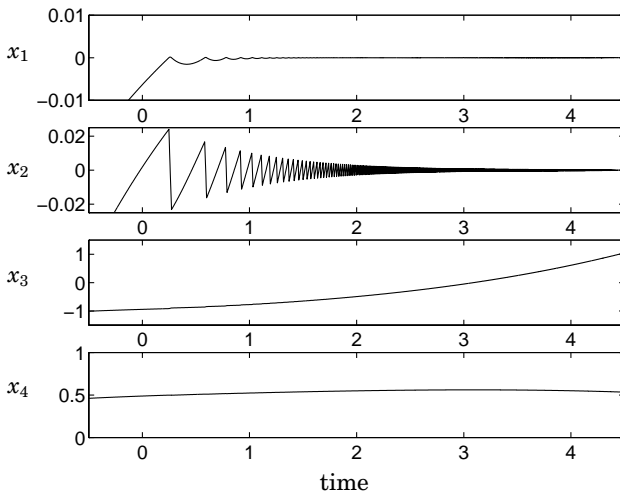

Figure 11. Fast oscillations in a limit cycle for system with pole excess two. The fast oscillations start at $x_3 = -1$ and end at $x_3 = 1$.

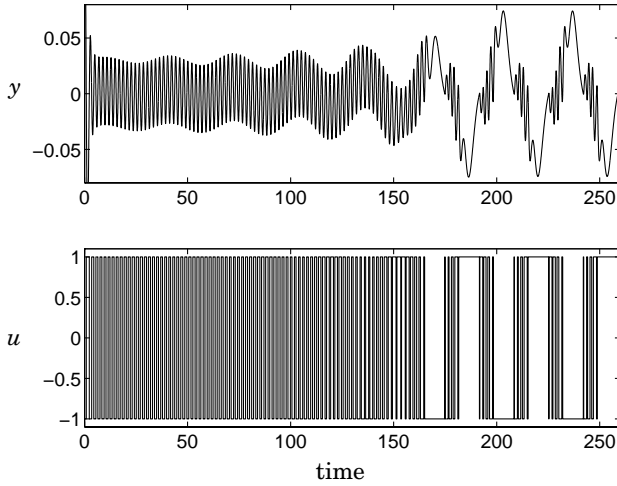

Figure 12. Convergence to a limit cycle for a system with pole excess three. The output $y = x_1$ of the linear system and the output u of the relay are shown.

Pole excess three—limit cycles with few fast switches

The analysis done for systems of pole excess one and two also carries over to systems of higher-order pole excess. Next, we show an example of a system with pole excess three, which has a limit cycle with a few fast switches each period.

EXAMPLE 9
Consider

$$G(s) = \frac{(s - \zeta)^2}{(s + 1)^5}, \quad \zeta > 0$$

with state-space representation

$$\dot{x} = \begin{pmatrix} -5 & 1 & 0 & 0 & 0 \\ -10 & 0 & 1 & 0 & 0 \\ -10 & 0 & 0 & 1 & 0 \\ -5 & 0 & 0 & 0 & 1 \\ -1 & 0 & 0 & 0 & 0 \end{pmatrix} x + \begin{pmatrix} 0 \\ 0 \\ 1 \\ -2\zeta \\ \zeta^2 \end{pmatrix} u,$$

$$y = \begin{pmatrix} 1 & 0 & 0 & 0 & 0 \end{pmatrix} x.$$

Let $\zeta = 0.12$ and $x(0) = (0, 1, 0, 0, 0)$. The convergence to the stable limit cycle is complicated as shown in Figures 12 and 13.

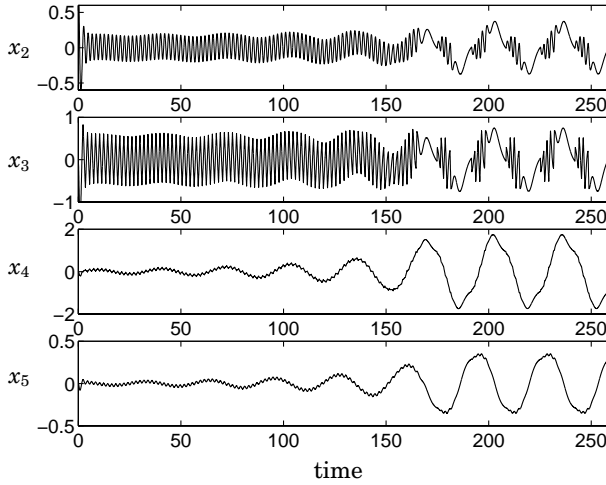

Figure 13. The state variables x_2, \dots, x_5 converging to a limit cycle for a system with pole excess three.

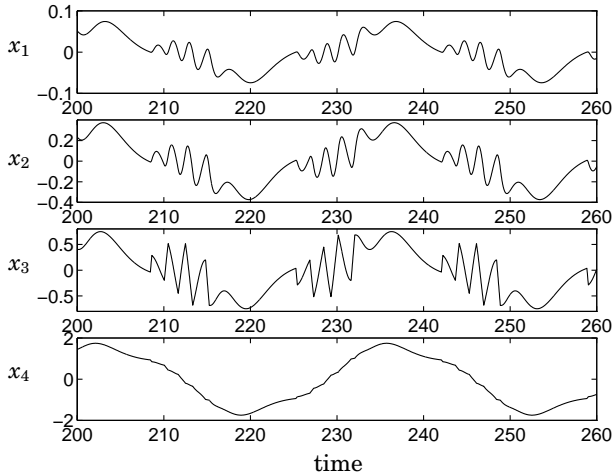

Figure 14. A few fast switches occur each period of the limit cycle. These start and stop at $x_4 = \pm 1$, that is, when $|CA^3x| = CA^2B$. (The state x_5 is not shown here, but it is approximately constant during the fast switches.)

The limit cycle characteristics can, however, be predicted also in this case. Figure 14 shows x_1, \dots, x_4 during the limit cycle. Because the pole excess is three, the fast switches do not last long. Only nine relay switches occur each time the fast switches appear. Note, as we may expect, it is the

points where $|CA^3x| = CA^2B$ that determines when the fast switching starts and ends. In this example they correspond to $x_4 = \pm 1$. The state x_5 is approximately constant during the fast switch phase. \square

7. Conclusions

The problem of characterizing behaviors in relay feedback systems has been addressed. It was motivated by a number of examples from the literature, where the main one was the automatic tuning procedure of PID controllers using relay feedback by Åström and Hägglund. Another motivation for the study of relay feedback systems is their connection to hybrid systems [Morse, 1995]. The system we have considered can be viewed as a simple hybrid system that consists of only one discrete state.

The main result of the paper was a complete characterization of all relay feedback systems that have initial states that give multiple fast relay switches. It was shown that multiple fast switches exist if and only if the first non-vanishing Markov parameter is positive. The nature of the fast behavior was further investigated. It was shown that there is a fundamental difference between systems of pole excess one, pole excess two, and pole excess greater than two. The fast behavior of these systems can be studied via relay feedback of an integrator, double integrator, and a higher-order integrator. The results on fast switches were applied to analysis of limit cycles, where part of the limit cycle consists of a number of fast switches. Future work will include stability analysis of these limit cycles. Local stability analysis of limit cycles without fast switches was also done. It was proved that two conditions in the literature are equivalent in most cases.

8. References

- ANDRONOV, A. A., S. E. KHAIKIN, and A. A. VITT (1965): *Theory of oscillators*. Pergamon Press, Oxford.
- ANOSOV, D. V. (1959): "Stability of the equilibrium positions in relay systems." *Automation and Remote Control*, **20**, pp. 135–149.
- ÅSTRÖM, K. J. (1995): "Oscillations in systems with relay feedback." In ÅSTRÖM *et al.*, Eds., *Adaptive Control, Filtering, and Signal Processing*, vol. 74 of *IMA Volumes in Mathematics and its Applications*, pp. 1–25. Springer-Verlag.

- ÅSTRÖM, K. J. and T. HÄGGLUND (1984a): "Automatic tuning of simple regulators." In *Preprints 9th IFAC World Congress*, pp. 267–272. Budapest, Hungary.
- ÅSTRÖM, K. J. and T. HÄGGLUND (1984b): "Automatic tuning of simple regulators with specifications on phase and amplitude margins." *Automatica*, **20**, pp. 645–651.
- ÅSTRÖM, K. J. and T. HÄGGLUND (1995): *PID Controllers: Theory, Design, and Tuning*, second edition. Instrument Society of America, Research Triangle Park, NC.
- ATHERTON, D. P. (1975): *Nonlinear Control Engineering: Describing Function Analysis and Design*. Van Nostrand Reinhold Co., London, U.K.
- ATHERTON, D. P. (1993): "Analysis and design of relay control systems." In LINKENS, Ed., *CAD for control systems*, chapter 15, pp. 367–394. Marcel Dekker.
- ATHERTON, D. P., O. P. MCNAMARA, and A. GOUCEM (1985): "SUNS: The Sussex University nonlinear control systems software." In *Preprints CADCE*. Copenhagen.
- BALASUBRAMANIAN, R. (1981): "Stability of limit cycles in feedback systems containing a relay." *IEE Proc D*, **128:1**, pp. 24–29.
- FILIPPOV, A. F. (1988): *Differential Equations with Discontinuous Right-hand Sides*. Kluwer Academic Publishers.
- FLÜGGE-LOTZ, I. (1953): *Discontinuous automatic control*. Princeton University Press.
- FLÜGGE-LOTZ, I. (1968): *Discontinuous and optimal control*. McGraw-Hill, New York, NY.
- FRIDMAN, L. M. and A. LEVANT (1996): "Higher order sliding modes as a natural phenomenon in control theory." In GAROFALO AND GLIELMO, Eds., *Robust Control via Variable Structure & Lyapunov Techniques*, vol. 217 of *Lecture notes in control and information science*, pp. 107–133. Springer-Verlag.
- HOLMBERG, U. (1991): *Relay Feedback of Simple Systems*. PhD thesis TFRT-1034, Department of Automatic Control, Lund Institute of Technology, Lund, Sweden.
- JOHANSSON, K. H. and A. RANTZER (1996): "Global analysis of third-order relay feedback systems." In *Preprints IFAC 13th World Congress*, vol. E, pp. 55–60. San Francisco, CA.

- LUNDH, M. and K. J. ÅSTRÖM (1994): "Automatic initialization of a robust self-tuning controller." *Automatica*, **30:11**, pp. 1649–1662.
- MEES, A. I. (1981): *Dynamics of Feedback Systems*. John Wiley & Sons.
- MEGRETSKI, A. (1996): "Global stability of oscillations induced by a relay feedback." In *Preprints IFAC 13th World Congress*, vol. E, pp. 49–54. San Francisco, CA.
- MORSE, A. S. (1995): "Control using logic-based switching." In ISIDORI, Ed., *Trends in Control. A European Perspective*, pp. 69–113. Springer.
- PARKER, S. R. and S. F. HESS (1971): "Limit cycle oscillations in digital filters." *IEEE Trans. Circ. Theory*, **CT-18**, pp. 687–697.
- SHEVITZ, D. and B. PADEN (1994): "Lyapunov stability theory of nonsmooth systems." *IEEE Transactions on Automatic Control*, **39:9**, pp. 1910–1914.
- SMITH, R. S. and J. C. DOYLE (1993): "Closed loop relay estimation of uncertainty bounds for robust control models." In *Preprints 12th IFAC World Congress*, vol. 9, pp. 57–60. Sydney, Australia.
- TSYPKIN, YA. Z. (1984): *Relay Control Systems*. Cambridge University Press, Cambridge, U.K.
- UTKIN, V. I. (1987): "Discontinuous control systems: State of the art in theory and applications." In *Preprints 10th IFAC World Congress*. Munich, Germany.
- WADEY, M. D. and D. P. ATHERTON (1986): "A simulation study of unstable limit cycles." In *IFAC Simulation of Control Systems*, pp. 149–154. Vienna, Austria.
- YAKUBOVICH, V. A. (1964): "The absolute stability of nonlinear control systems in critical cases. III." *Automation and Remote Control*, **25:5**, pp. 601–612.
- YAKUBOVICH, V. A. (1973): "Frequency-domain criteria for oscillation in nonlinear systems with one stationary nonlinear component." *Sibirskii Matematicheskii Zhurnal*, **14:5**, pp. 1100–1129.

Paper 2

Limit Cycles with Chattering in Relay Feedback Systems

**Karl Henrik Johansson, Andrey Barabanov,
and Karl Johan Åström**

Abstract

Several interesting behaviors occur in relay feedback systems. One of them is a limit cycle where part of the limit cycle consists of fast relay switches. This chattering is analyzed in detail and conditions for approximating it by a sliding mode are derived. Stability conditions are proved for limit cycles with regular sliding modes as well as with chattering. Simulated examples illustrate these new results.

1. Introduction

Relay-like functions are used in many control systems. Mechanical and electromechanical systems were an early motivation for studying relay feedback systems [Andronov *et al.*, 1965; Tsytkin, 1984]. Lately there has been renewed interest due to a variety of applications, for example, automatic tuning of PID controllers [Åström and Hägglund, 1995], modeling of quantization errors in digital control [Parker and Hess, 1971], analysis of sigma-delta converters [Aziz *et al.*, 1996], design of variable-structure systems [Utkin, 1992], and investigation of hybrid systems [Morse, 1995].

Consider a linear time-invariant system with relay feedback. The linear system has scalar input u and scalar output y and it is described by

$$\begin{aligned} \dot{x} &= Ax + Bu, \\ y &= Cx, \end{aligned} \tag{1}$$

with $x \in \mathbf{R}^n$. Let $G(s) = b(s)/a(s)$ be the transfer function of the system. The relay feedback is defined by

$$u = -\operatorname{sgn} y = \begin{cases} -1, & \text{if } y > 0, \\ 1, & \text{if } y < 0, \end{cases} \tag{2}$$

so the relay does not have hysteresis. The switch plane \mathcal{S} is the hyperplane of dimension $n - 1$ where the output vanishes, that is, $\mathcal{S} = \{x : Cx = 0\}$.

It is well-known that a linear system with relay feedback can show several interesting phenomena. Some of them can be analyzed with frequency methods [Atherton, 1975; Tsytkin, 1984]. However, more complicated behaviors such as sliding modes must be treated with other mathematical tools [Filippov, 1988; Utkin, 1992; Fridman and Levant, 1996]. There exist trajectories having arbitrarily fast relay switches even if an exact sliding mode is not part of the trajectory. It was shown in [Johansson *et al.*, 1997] that a necessary and sufficient condition for this is that the first non-vanishing Markov parameter is positive. In the same paper, it was shown through simulations that this type of chattering can be part of a stable limit cycle. The main contribution of this paper is to give conditions for existence and stability of such a limit cycle. In particular, it is shown to be sufficient to study a second-order sliding mode instead of the complicated map that describes the chattering.

The paper is organized as follows. Sliding sets and sliding modes are recalled in Section 2. Section 3 gives a result on approximation of chattering by sliding modes. In Section 4 this result is used to show existence and stability of limit cycles with chattering. Stability conditions for limit

cycles with first-order sliding modes are also shown. Conclusions are given in Section 5. All proofs are collected in Appendix.

2. Sliding Modes

We follow the terminology of [Fridman and Levant, 1996; Levant, 1997] and define the first-order (or regular) sliding set as

$$S_1 := \{x : Cx = 0\} = S$$

and the second-order sliding set as

$$S_2 := \{x : Cx = CAx = 0\}.$$

Trajectories of (1)–(2) in these sets are defined in the sense of Filippov, that is, they are defined as solutions satisfying almost everywhere a differential inclusion corresponding to (1)–(2), see [Filippov, 1988]. A first-order sliding mode is defined as this motion on S_1 and a second-order sliding mode as the motion on S_2 . Higher-order sliding modes can be defined similarly. It is, however, shown in [Johansson *et al.*, 1997] that a system (1)–(2) with pole excess greater than two do not have any solutions converging to higher-order sliding sets. Therefore, these systems are not discussed further. Let $\Sigma_1 = (A, B_1, C)$ and $\Sigma_2 = (A, B_2, C)$ represent the state-space system (1) with parameterizations given by

$$A = \begin{pmatrix} -a_1 & 1 & 0 & \dots & 0 \\ -a_2 & 0 & 1 & & 0 \\ \vdots & & & \ddots & \vdots \\ -a_{n-1} & 0 & 0 & & 1 \\ -a_n & 0 & 0 & \dots & 0 \end{pmatrix},$$

$$B_1 = \begin{pmatrix} 1 & b_1 & \dots & b_{n-1} \end{pmatrix}^T,$$

$$B_2 = \begin{pmatrix} 0 & 1 & b_1 & \dots & b_{n-2} \end{pmatrix}^T,$$

$$C = \begin{pmatrix} 1 & 0 & \dots & 0 \end{pmatrix},$$

where A is assumed to be nonsingular. Note that Σ_1 and Σ_2 are normalized such that $CB = 1$ and $CAB = 1$, respectively. For the system (1)–(2) a first-order sliding mode only exists if $CB > 0$ and a second-order sliding mode only if $CB = 0$ and $CAB > 0$, so for Σ_1 there exists a first-order

sliding mode whereas for Σ_2 there exists a second-order sliding mode. For systems with pole excess two, the initial data that give a sliding mode lie in a set with lower dimension than for systems with pole excess one. This means basically that an exact second-order sliding will never occur. Still there can exist trajectories with arbitrarily fast relay switches which wind around the second-order sliding set. We call this phenomenon *chattering* and it is analyzed in next section.

There are several ways to derive a sliding mode. For a general non-smooth system they do not necessarily agree, but they do so for linear systems with relay feedback [Filippov, 1988]. A convenient way to derive the sliding modes is to replace u in (1) by an equivalent control $u_{\text{eq}} \in [-1, 1]$ that impose restrictions on y and the derivatives of y , see [Utkin, 1992]. For Σ_1 the equivalent control is $u_{\text{eq}} = -CAx/CB = -x_2$, because $x_1 = 0$ for the first-order sliding mode. This gives the first-order sliding mode for Σ_1 as $x_1 = 0$ together with the solution of

$$\dot{w} = F_1 w,$$

where $w = (x_i)_{i=2}^n$ and

$$F_1 = \begin{pmatrix} -b_1 & 1 & 0 & \cdots & 0 \\ -b_2 & 0 & 1 & & 0 \\ \vdots & & & \ddots & \vdots \\ -b_{n-2} & 0 & 0 & & 1 \\ -b_{n-1} & 0 & 0 & \cdots & 0 \end{pmatrix}. \quad (3)$$

The sliding mode is thus stable ($w \rightarrow 0$) if all zeros of Σ_1 are in the open left half-plane. It follows from $u_{\text{eq}} = -x_2$ and $1 \leq u_{\text{eq}} \leq 1$ that the sliding mode occurs only for $|x_2| < 1$.

The sliding mode for Σ_2 can be derived similarly. It is given by $x_1 = x_2 = 0$ and the solution of

$$\dot{w} = F_2 w,$$

where $w = (x_i)_{i=3}^n$ and

$$F_2 = \begin{pmatrix} -b_1 & 1 & 0 & \cdots & 0 \\ -b_2 & 0 & 1 & & 0 \\ \vdots & & & \ddots & \vdots \\ -b_{n-3} & 0 & 0 & & 1 \\ -b_{n-2} & 0 & 0 & \cdots & 0 \end{pmatrix}. \quad (4)$$

A second-order sliding mode occurs only for $|x_3| < 1$.

3. Chattering

It was mentioned in the previous section that an exact sliding mode will not occur for systems with pole excess two, because S_2 is of lower dimension. Still, arbitrarily fast relay switches can occur, which we call chattering. For the parameterization given by Σ_2 the *chattering variables* are x_1 and x_2 , whereas x_3, \dots, x_n are *smooth variables*. “Chattering” discussed here should not be mixed up with fast relay switches occurring in systems with relay imperfections such as hysteresis. The system description here is exact and the chattering can be described as a trajectory close to a second-order sliding mode in S_2 .

A trajectory for Σ_2 with relay feedback that starts at a point $x(0)$ with $x_1(0) = 0$, $|x_3(0)| < 1$, and $x_2(0)$ sufficiently small will wind around the set S_2 . This follows from Theorem 1 given next, which states a first-order approximation for the amplitude of this chattering. A necessary and sufficient condition for the stability of the chattering is also obtained.

THEOREM 1

Consider Σ_2 with order $n \geq 3$ under relay feedback (2). Assume $x_1(0) = 0$, $x_2(t)$ is small, and $|x_3(t)| < 1$ for $t \in [0, T]$. Let the switch times be denoted by t_k , $k \geq 1$, so that $x_1(t_k) = 0$. Then the chattering variable x_1 satisfies

$$\frac{1}{|x_2(0)|} \sup_{t \in [0, T]} |x_1(t)| \rightarrow 0, \quad \text{as } |x_2(0)| \rightarrow 0$$

and the envelope of the peaks of the chattering variable x_2 is given by

$$\begin{aligned} x_2(t_k) &= (-1)^k x_2(0) \exp \left[- (a_1 - b_1) t_k / 3 \right] \\ &\quad \times \left(\frac{1 - x_3^2(t_k)}{1 - x_3^2(0)} \right)^{1/3} + \varepsilon_1(x_2(0); t_k), \end{aligned} \quad (5)$$

where $\varepsilon_1(x_2(0); t_k)/x_2(0) \rightarrow 0$ as $x_2(0) \rightarrow 0$ uniformly for all k with $t_k \in [0, T]$.

Proof: See Appendix. □

REMARK 1 The chattering can be stable or unstable. Theorem 1 gives a simple necessary and sufficient condition for stability:

$$a_1 > b_1.$$

This requirement is equivalent to the heuristic condition given in Section 5 in [Johansson *et al.*, 1997]. Therein it is argued that for high frequencies

$$G(s) \approx \frac{K}{s(s + a_1 - b_1)}, \quad K > 0,$$

so a root-locus argument gives that the chattering is stable if and only if $a_1 - b_1 > 0$.

REMARK 2 The solution of a linear system depends continuously on the initial data. This gives that the smooth variables $x_{\text{sm}} = (x_i)_{i=2}^n$ are close to the corresponding sliding mode $w(t)$:

$$\begin{aligned} x_{\text{sm}}(t) &= w(t) + \varepsilon_2(x_2(0); t), \\ \dot{w}(t) &= F_2 w(t), \end{aligned}$$

for $t \in [0, T]$, where $\varepsilon_2(x_2(0); t)/x_2(0) \rightarrow 0$ as $x_2(0) \rightarrow 0$ and F_2 is given by (4).

The following result is a formula for the number of switches on a chattering trajectory.

THEOREM 2

Given the assumptions in Theorem 1, the number of switches on the interval $[0, \tilde{T}]$ is equal to

$$K = \frac{1}{|x_2(0)|} \left[\frac{1}{2} (1 - x_3^2(0))^{1/3} \int_0^{\tilde{T}} \exp [(a_1 - b_1)t/3] (1 - x_3^2(t))^{2/3} dt + \varepsilon_3(x_2(0); \tilde{T}) \right], \quad (6)$$

where $\varepsilon_3(x_2(0); \tilde{T}) \rightarrow 0$ as $x_2(0) \rightarrow 0$ uniformly for $\tilde{T} \in [0, T]$.

Proof: See Appendix. □

REMARK 3 Equation (5) captures the behavior of chattering quite well. Consider a chattering solution that starts with x_1 and x_2 small and $|x_3|$ close to one. Because x_2 changes rapidly in comparison with x_3 , Equation (5) tells that x_2 oscillates with exponentially decreasing amplitude. The length of the switch intervals will decrease as x_2 decreases. As $|x_3|$ approaches one it follows from (6) that the interval between switches increases again. Note that (5) and (6) are not proved for $|x_3(t)| \rightarrow 1$ and that they are singular for $|x_3(0)| = 1$. This will be subject to further research.

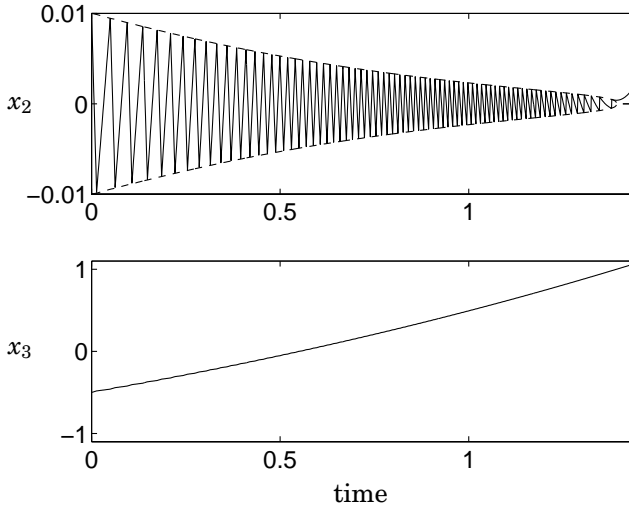

Figure 1. Chattering for a fourth-order system (solid) together with envelope estimate from Theorem 1 (dashed). The chattering ends when $x_3(t)$ becomes greater than one.

EXAMPLE 1

Consider

$$G(s) = \frac{(s - \zeta)^2}{(s + 1)^4}$$

with state-space representation

$$\dot{x} = \begin{pmatrix} -4 & 1 & 0 & 0 \\ -6 & 0 & 1 & 0 \\ -4 & 0 & 0 & 1 \\ -1 & 0 & 0 & 0 \end{pmatrix} x + \begin{pmatrix} 0 \\ 1 \\ -2\zeta \\ \zeta^2 \end{pmatrix} u,$$

$$y = \begin{pmatrix} 1 & 0 & 0 & 0 \end{pmatrix} x$$

and let $\zeta = 0.2$. Figure 1 shows a simulation of the system that starts in $x(0) = (10^{-10}, 0.010, -0.5, 1.0)$ (solid line) together with the continuous estimate of the envelope of $x_2(t)$ obtained from Theorem 1 (dashed lines). The chattering ends when $x_3(t)$ becomes greater than one. Note that the switch periods increase close to the end point of the chattering, as was mentioned in Remark 3. The estimated number of switches from Theorem 2 is $K = 151$, whereas the true number is 152. \square

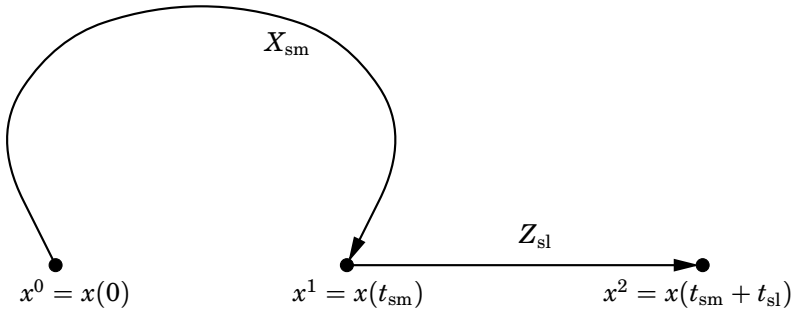

Figure 2. The variables defining the map Z , which consists of one smooth part X_{sm} and one sliding mode part Z_{sl} .

4. Stability of Limit Cycles

First-order sliding modes and chattering can be part of stable limit cycles. Necessary and sufficient conditions for local stability of these limit cycles are given in this section.

We start by defining a limit cycle. Let $\phi(t, x^0)$ denote a trajectory of (1)–(2) starting in x^0 . A *closed orbit* is a trajectory such that $\phi(t_1, x^0) = \phi(t_2, x^0)$ for some $t_1 < t_2$. A point p is a *limit point* of the trajectory if there exists a sequence $\{t_k\}$, with $t_k \rightarrow \infty$ as $k \rightarrow \infty$, such that $\phi(t_k, x^0) \rightarrow p$ as $k \rightarrow \infty$. The set of all limit points is the *limit set* of the trajectory and is denoted L . Finally, a *limit cycle* is a limit set that is a closed orbit. The limit cycle is *symmetric* if $x \in L$ implies that $-x \in L$ and it is *simple* if L intersects S only twice.

Limit cycles with first-order sliding modes

Simulated limit cycles where part of the trajectory is a first-order sliding mode are given in [Wadey and Atherton, 1986; Johansson *et al.*, 1997]. Stability and existence of these limit cycles can be straightforwardly analyzed by studying a Poincaré map that consists of a smooth part and a sliding mode part. Here we do this and derive its Jacobian.

Consider Σ_1 with relay feedback and suppose $b(s)$ has zeros in the open right half-plane. Then the sliding mode is unstable so every sliding mode ends in a point with $|x_2(t')| = 1$. The smooth part of the limit cycle starts at a point $x = (x_i)_{i=1}^n$, such that $(x_1, x_2) = (0, 1)$ if $x_3 > 0$ and $(x_1, x_2) = (0, -1)$ if $x_3 < 0$. The set of such points is symmetric and for that reason we only consider $x_2(t') = +1$. For any vector $z = (x_i)_{i=3}^n$ with $x_3 > 0$ we define the following variables illustrated in Figure 2:

- $X_{sm}(t, z)$ is the trajectory of the closed-loop system with initial data $x^0 = (0, 1, z^T)^T$;

- $t_{\text{sm}}(z)$ is the first positive instant for a switch of $X_{\text{sm}}(t, z)$;
- $y_{\text{sm}}(z) \in \mathbf{R}$ and $z_{\text{sm}}(z) \in \mathbf{R}^{n-1}$ are the components of the first switch point, i.e., $x^1 = x(t_{\text{sm}}(z)) = (y_{\text{sm}}(z)^T, z_{\text{sm}}(z)^T)^T$;
- $Z_{\text{sl}}(t, z)$ for $t > t_{\text{sm}}(z)$ is the trajectory of a sliding mode, which starts at the point $z_{\text{sm}}(z)$;
- $t_{\text{sl}}(z)$ is the sliding mode time, that is, the smallest t for which the end point $(v_i)_{i=1}^{n-1} := Z_{\text{sl}}(t + t_{\text{sm}}(z), z)$ satisfies the conditions $|v_1| = 1$ and $v_1 v_2 > 0$; and
- $Z(z) = -v_1(v_i)_{i=2}^n$ is the last $n - 1$ components of the final point with sign determined by v_1 .

The map Z is nonlinear, but consists of two linear parts parameterized by two scalars t_{sm} and t_{sl} . The smooth part is from x^0 to x^1 and the sliding mode is from x^1 to x^2 , see Figure 2. Let P_1 denote the projection $P_1(x)_{i=2}^n = (x)_{i=3}^n$, P_2 the projection $P_2(x)_{i=1}^n = (x)_{i=2}^n$, and P_3 the projection $P_3(x)_{i=1}^n = (x)_{i=3}^n$. Moreover, let e_1 be the unit row vector of length $n - 1$ with unity in the first position. We then have the following result.

THEOREM 3

Consider Σ_1 with order $n \geq 3$ under relay feedback (2). Assume there exists a symmetric simple limit cycle with a first-order sliding mode. Let $x^0 =: (0, \chi^T)^T$ be the fixed point of the map Z defined above, let x^1 , t_{sl} , and t_{sm} be the corresponding parameters of this map, and let F_1 be given as (3). Then the limit cycle is stable if and only if all eigenvalues of

$$W_1 = P_1 \left(I - \frac{F_1 \chi e_1}{e_1 F_1 \chi} \right) e^{F_1 t_{\text{sl}}} P_2 \left(I - \frac{(Ax^1 - B)C}{C(Ax^1 - B)} \right) e^{At_{\text{sm}}} P_3^T \quad (7)$$

are in the open unit disc.

Proof: See Appendix. □

REMARK 4 For limit cycles without sliding modes $t_{\text{sl}} = 0$ and Theorem 3 reduces to Theorem 3.1 in [Åström, 1995].

The definitions of x^0 , x^1 , and x^2 give two nonlinear equations in t_{sl} and t_{sm} . These may have several solutions. One or more can correspond to a stable limit cycle with sliding mode, see [Johansson *et al.*, 1997].

EXAMPLE 2

It was shown in [Johansson *et al.*, 1997] that

$$G(s) = \frac{(s-1)^2}{(s+1)^3} \quad (8)$$

with state-space representation

$$\begin{aligned} \dot{x} &= \begin{pmatrix} -3 & 1 & 0 \\ -3 & 0 & 1 \\ -1 & 0 & 0 \end{pmatrix} x + \begin{pmatrix} 1 \\ -2 \\ 1 \end{pmatrix} u \\ y &= \begin{pmatrix} 1 & 0 & 0 \end{pmatrix} x \end{aligned}$$

exhibit a limit cycle with first-order sliding mode under relay feedback with $t_{sl} = 0.39$ and $t_{sm} = 4.04$. Theorem 3 gives that the limit cycle is stable because $W_1 = -0.033$. \square

Limit cycles with chattering

Next we show that limit cycles with chattering can be analyzed similar to limit cycles with first-order sliding modes. Conditions for existence and stability of chattering limit cycles are derived.

Consider Σ_2 with relay feedback and assume that all poles are stable and that one or more zeros are unstable. We also assume that the sliding time is much longer than the period of the fast oscillations in the chattering variables (x_1, x_2) . Otherwise there will be no chattering, because the chattering stops when $|x_3(t)| > 1$ and this will happen after a small number of switches. Note that the second-order sliding mode is slow, if the unstable zeros of $b(s)$ are close to the origin.

Let us now translate some of the terminology of limit cycles with first-order sliding modes to chattering limit cycles. Every second-order sliding mode ends in a point with $|x_3(t')| = 1$. The smooth parts of the limit cycle always start at a point $x = (x_i)_{i=1}^n$, such that the subvector (x_1, x_2, x_3) is close to $(0, 0, 1)$ (if $x_4 \geq 0$) or $(0, 0, -1)$ (if $x_4 \leq 0$). We only consider $x_3(t') = +1$. The variables defined prior to Theorem 3 are easily modified. For example, $z = (x_4, \dots, x_n)^T$ with $x_4 > 0$ and $x^0 = (0, 0, 1, z^T)^T$. The Jacobian W_2 of Z is given by (7) with F_1 replaced by F_2 and obvious changes of matrix dimensions. The map Z still consists of a smooth part and an exact second-order sliding mode part.

To prove stability of a chattering limit cycle, we need to confirm that the chattering is sufficiently close to a second-order sliding mode. The analysis of chattering in the previous section showed that the chattering

variable x_2 can be approximated to a high accuracy by a product of an exponential function and a gain, where the gain depends on the smooth variable x_3 as stated in Theorem 1. If this exponential function is decreasing, there is contraction in the chattering variable x_2 and therefore also in the chattering variable x_1 . The smooth state variables can then be approximated by the differential equation for the sliding mode. The accuracy is proportional to the amplitude of x_2 . If the differential equation for the smooth state variables also gives a contraction, then the two contractions give a Lyapunov function for the full system. Such a system has a stable limit cycle containing one smooth and one chattering part. This is formulated in the following theorem.

THEOREM 4

Consider Σ_2 with order $n \geq 4$ under relay feedback (2). Assume the corresponding polynomial $a(s)$ is stable, $b(s)$ is unstable, $G(0) > 0$, and that the following conditions hold:

1. The map Z has a fixed point z^0 and the matrix W_2 has all eigenvalues in the open unit disc;
2. The inequality $a_1 > b_1$ is satisfied; and
3. The first component of $e^{At}(0, 0, 0, (z^0)^T)^T$ is positive for all $t > 0$.

If all zeros of $b(s)$ are sufficiently close to the origin (compared to the zeros of $a(s)$), then there exists a symmetric stable limit cycle with chattering. The limit cycle is close to the trajectory $X_{sm}(t, z^0)$ for $t \in [0, t_{sm}(z^0)]$ and the $n - 2$ smooth variables of the limit cycle are close to $Z_{sl}(t, z^0)$ for $t \in [t_{sm}(z^0), t_{sm}(z^0) + t_{sl}(z^0)]$.

Proof: See Appendix. □

REMARK 5 Theorem 4 states that it is sufficient to study the map Z that consists of a second-order sliding mode part and a smooth part, instead of the complicated map that describes a chattering part and a smooth part.

REMARK 6 The assumptions on the steady-state gain $G(0) > 0$ and the zeros of $G(s)$ close to the origin have the following geometric interpretations. The stationary point for $\dot{x} = Ax - B_2$ is $\hat{x} = A^{-1}B_2$. Hence, $G(0) = -CA^{-1}B_2 > 0$ is equivalent to that $C\hat{x} < 0$, so positive steady-state gain guarantees a relay switch to occur. Furthermore, the stationary point \hat{x} belongs to the hyperplane $\{x : CA^2x - CAB_2 = 0\} = \{x : x_3 = 1\}$. A Taylor expansion shows that $CA^{-1}B_2$ is small, if all zeros of $G(s)$ are close to the origin compared to the poles. The trajectory of the system will

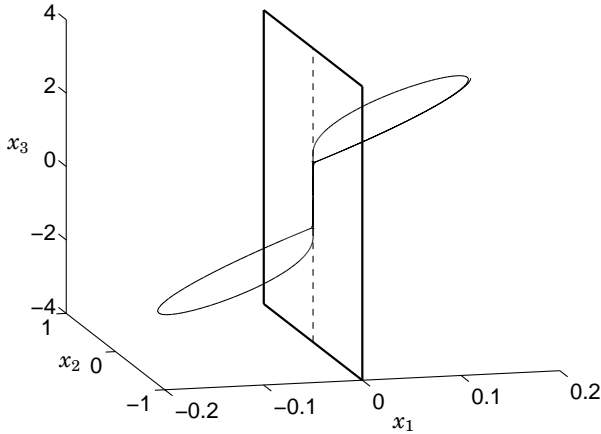

Figure 3. Limit cycle with chattering for a system with pole excess two. The dashed line is the second-order sliding set S_2 .

approach a point close to where $(x_1, x_2, x_3) = (0, 0, 1)$. The assumptions of Theorem 1 is thus fulfilled if all zeros are close to the origin.

The assumptions of Theorem 4 are not very restrictive. The key conditions are that the zeros of $b(s)$ should be small (yielding a long sliding mode) and that there should exist a stable stationary point for the associated quasi-linear map. The other conditions are, for example, always fulfilled for the following fourth-order case.

LEMMA 1

Suppose the dimension of the system is $n = 4$. If all zeros of $a(s)$ are real and stable and all zeros of $b(s)$ are unstable, then Conditions 2 and 3 of Theorem 4 are satisfied.

Proof: See Appendix. □

Convergence to a limit cycle with chattering for a fourth-order system was shown by simulations in [Johansson *et al.*, 1997]. Next, it is proved formally by application of Theorem 4 and Lemma 1 that it is stable.

EXAMPLE 3

Consider again the system in Example 1. The parameter $\zeta = 0.2$ gives zeros that are sufficiently close to the origin to give a limit cycle with chattering. Figure 3 shows the limit cycle in the subspace (x_1, x_2, x_3) . The fast oscillations in the chattering mode are magnified in Figure 4. Figure 5 shows the four state variables during the chattering mode. In agreement

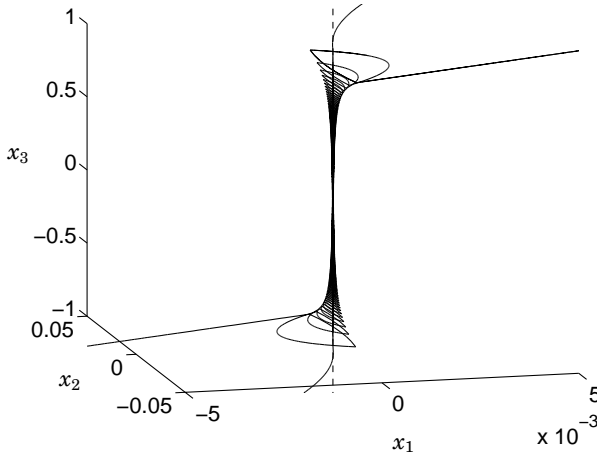

Figure 4. A closer look on the winding around the second-order sliding set S_2 (dashed line).

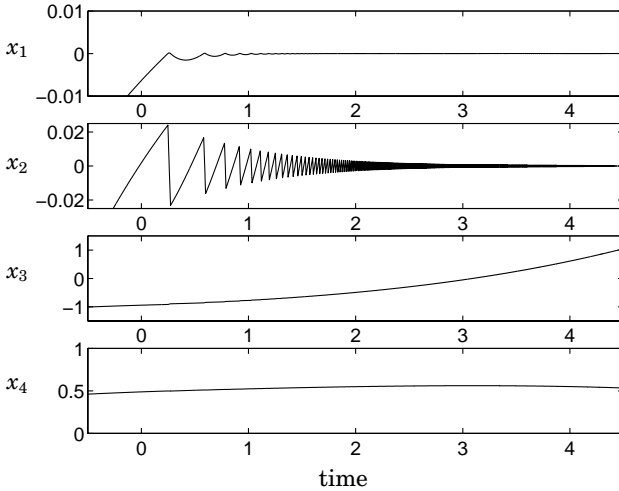

Figure 5. Chattering in a limit cycle for a system with pole excess two. The chattering starts at $x_3 = -1$ and ends at $x_3 = 1$.

with the analysis above, the chattering mode starts at $x_3(t) = -1$, ends at $x_3(t) = 1$, and $x_4(t)$ is almost constant. Similar derivations as described in Example 2 give $t_{sm} = 7.5$ and $t_{sl} = 4.3$, whereas simulations give a smooth time of 7.4 and and chattering time of 4.2. The fixed point of Z is $z^0 = 0.54$, which is approximately the value of x_4 in Figure 5 when

x_3 becomes greater than one. The Jacobian $W_2 = -0.0025$ is stable, so therefore the chattering limit cycle is stable. \square

5. Conclusions

Trajectories winding around a second-order sliding set in relay feedback systems were described. Conditions for existence and stability of this chattering were derived. Limit cycles with chattering were also discussed and stability conditions for both limit cycles with first-order sliding modes and chattering were obtained.

Chattering occurs in systems with pole excess two. This type of phenomenon can, however, not occur in systems with higher-order pole excess. It can be understood intuitively, because a system whose first non-vanishing Markov parameter M is of order k behaves similar to M/s^k . A double integrator gives a limit cycle with arbitrarily fast period, whereas higher order integrators are unstable under relay feedback, see [Johansson *et al.*, 1997] for further details. Simulation therein shows that for systems with pole excess three, there exist limit cycles with only a few extra switches each period.

The examples were simulated in OmSim, a simulation package for continuous-time and discrete-event dynamical systems [Andersson, 1994].

6. References

- ANDERSSON, M. (1994): *Object-Oriented Modeling and Simulation of Hybrid Systems*. PhD thesis ISRN LUTFD2/TFRT--1043--SE, Department of Automatic Control, Lund Institute of Technology, Lund, Sweden.
- ANDRONOV, A. A., S. E. KHAIKIN, and A. A. VITT (1965): *Theory of oscillators*. Pergamon Press, Oxford.
- ÅSTRÖM, K. J. (1995): "Oscillations in systems with relay feedback." In ÅSTRÖM *et al.*, Eds., *Adaptive Control, Filtering, and Signal Processing*, vol. 74 of *IMA Volumes in Mathematics and its Applications*, pp. 1–25. Springer-Verlag.
- ÅSTRÖM, K. J. and T. HAGGLUND (1995): *PID Controllers: Theory, Design, and Tuning*, second edition. Instrument Society of America, Research Triangle Park, NC.

- ATHERTON, D. P. (1975): *Nonlinear Control Engineering: Describing Function Analysis and Design*. Van Nostrand Reinhold Co., London, U.K.
- AZIZ, P. M., H. V. SORENSSEN, and J. VAN DER SPIEGEL (1996): "An overview of sigma-delta converters." *IEEE Signal Processing Magazine*, January, pp. 61–84.
- FILIPPOV, A. F. (1988): *Differential Equations with Discontinuous Right-hand Sides*. Kluwer Academic Publishers.
- FRIDMAN, L. M. and A. LEVANT (1996): "Higher order sliding modes as a natural phenomenon in control theory." In GAROFALO AND GLIELMO, Eds., *Robust Control via Variable Structure & Lyapunov Techniques*, vol. 217 of *Lecture notes in control and information science*, pp. 107–133. Springer-Verlag.
- JOHANSSON, K. H., A. RANTZER, and K. J. ÅSTRÖM (1997): "Fast switches in relay feedback systems." Submitted for journal publication.
- LEVANT, A. (1997): "Higher order sliding: Collection of design tools." In *European Control Conference*. Brussels, Belgium.
- MORSE, A. S. (1995): "Control using logic-based switching." In ISIDORI, Ed., *Trends in Control. A European Perspective*, pp. 69–113. Springer.
- PARKER, S. R. and S. F. HESS (1971): "Limit cycle oscillations in digital filters." *IEEE Trans. Circ. Theory*, **CT-18**, pp. 687–697.
- TSYPKIN, YA. Z. (1984): *Relay Control Systems*. Cambridge University Press, Cambridge, U.K.
- UTKIN, V. I. (1992): *Sliding Modes in Control Optimization*. Springer-Verlag, Berlin.
- WADEY, M. D. and D. P. ATHERTON (1986): "A simulation study of unstable limit cycles." In *IFAC Simulation of Control Systems*, pp. 149–154. Vienna, Austria.

Appendix

Proof of Theorem 1: Assume $x_1(0) = 0$, $x_2(0)$ is small, and $|x_3(0)| < 1$. For $t > 0$ up to next switch instant, it holds that

$$\begin{aligned} x(t) &= e^{At}x(0) + (e^{At} - I)A^{-1}Bu \\ &= x(0) + t(Ax(0) + Bu) + \frac{t^2}{2}(A^2x(0) + ABu) \\ &\quad + \frac{t^3}{6}(A^3x(0) + A^2Bu) + \kappa(t)t^4, \end{aligned}$$

where $u = \pm 1$ is constant and

$$|\kappa(t)| \leq \max_{\xi \in (0,t)} \|e^{A\xi}A^3(Ax(0) + Bu)\|/24.$$

Note that it follows from $CAB = 1 > 0$ that there will be a next switch if $x_2(0)$ is sufficiently small. For the sake of simplicity, introduce the notation

$$\begin{aligned} \alpha_1 &:= CAx(0) = x_2(0), \\ \alpha_2 &:= CA^2x(0) + CABu = x_3(0) + u - a_1x_2(0) \approx x_3(0) + u, \\ \alpha_3 &:= CA^3x(0) + CA^2Bu \approx x_4(0) + b_1u - a_1(x_3(0) + u), \end{aligned}$$

where the last equation holds if the order $n \geq 4$. If $n = 3$ this equation and the following still holds, but with $x_4 \equiv 0$. Note that $\alpha_1u = -|\alpha_1| < 0$ and that $\alpha_1\alpha_2 < 0$. Now assume that t is the next switch instant, that is, $Cx(t) = x_1(t) = 0$. Then it holds that

$$0 = x_1(t) = \alpha_1t + \alpha_2t^2/2 + \alpha_3t^3/6 + O(t^4), \quad (9)$$

$$CAx(t) = x_2(t) = \alpha_1 + \alpha_2t + \alpha_3t^2/2 + O(t^3), \quad (10)$$

for small t . Introduce t_0 as an approximation of t to the accuracy of $O(t^3)$ through the equation

$$\alpha_1 + \alpha_2t_0/2 + \alpha_3t_0^2/6 = 0. \quad (11)$$

Then, because

$$\frac{1}{1 + \sqrt{1 - \beta}} = \frac{1}{2} + \frac{1}{8}\beta + O(\beta^2),$$

for small β , we get

$$t_0 = \frac{4|\alpha_1|}{|\alpha_2| + \sqrt{\alpha_2^2 - 8\alpha_1\alpha_3/3}} = \frac{2|\alpha_1|}{|\alpha_2|} \left(1 + \frac{2}{3} \cdot \frac{\alpha_1\alpha_3}{\alpha_2^2} + O(\alpha_1^3) \right) \quad (12)$$

as $x_2(0) = \alpha_1 \rightarrow 0$. It is obvious from this expression that t_0 has the same order as α_1 as $\alpha_1 \rightarrow 0$. For this reason the expressions $O(t^k)$ and $O(\alpha_1^k)$ are equivalent for every $k > 0$. In particular, from (9) we have that $x_1(\tau) = O(x_2^2(0))$ as $x_2(0) \rightarrow 0$ for all $\tau \in [0, t]$, which proves the first equation in the theorem. In the following, it will be shown that $x_2(t)$ is proportional to $x_2(0)$ and (5) will be derived.

Let $\tilde{\alpha}_1 := x_2(t)$ be the starting point for the next part of the trajectory in the chattering mode between two successive switches. The map $\alpha_1 \mapsto \tilde{\alpha}_1$ describes the envelope of $x_2(t)$ in the chattering mode. By substituting t with t_0 and taking into account that $\alpha_1\alpha_2 < 0$ at any switch point, we get from (10) and (11) that

$$\tilde{\alpha}_1 = \alpha_1 + \alpha_2 t_0 - 3(\alpha_1 + \alpha_2 t_0/2) + O(\alpha_1^3) = -2\alpha_1 - \frac{1}{2}\alpha_2 t_0 + O(\alpha_1^3).$$

Then, (12) gives

$$\tilde{\alpha}_1 = -\alpha_1 \left(1 - \frac{2}{3} \frac{\alpha_1 \alpha_3}{\alpha_2^2} \right) + O(\alpha_1^3) = -\alpha_1 \left(1 + \frac{\alpha_3}{3\alpha_2} t + O(t^2) \right), \quad (13)$$

where the last equality follows from (9). The variable $x_2(t)$ thus shifts sign in successive switch points. After neglecting these sign shifts, the last equation looks very similar to a one-step iteration of a numerical solution to a differential equation. Next, we show that such a differential equation exists and that it describes the envelope of $x_2(t)$ at the switch instants t_k . It is surprising that this equation can be analytically integrated.

Consider three successive switch points at the time instants 0, t , and $t+\tilde{t}$. The relay output u has opposite sign in the intervals $(0, t)$ and $(t, t+\tilde{t})$. This influences α_2 , so that it shows a gap in two successive switch points. After two switches, however, α_2 is close to its initial value. Denote x_2 in three successive switch points by α_1 , $\tilde{\alpha}_1$, and $\tilde{\tilde{\alpha}}_1$, respectively. Denote by $\tilde{\alpha}_2$ and $\tilde{\tilde{\alpha}}_2$ the corresponding values for α_2 and α_3 . It was proved above that

$$\begin{aligned} \tilde{\alpha}_1 &= -\alpha_1(1 + \gamma) + O(\alpha_1^3), & \gamma &:= -\frac{2}{3} \cdot \frac{\alpha_1 \alpha_3}{\alpha_2^2}, \\ \tilde{\tilde{\alpha}}_1 &= -\tilde{\alpha}_1(1 + \tilde{\gamma}) + O(\tilde{\alpha}_1^3), & \tilde{\gamma} &:= -\frac{2}{3} \cdot \frac{\tilde{\alpha}_1 \tilde{\alpha}_3}{\tilde{\alpha}_2^2}. \end{aligned}$$

Therefore, after two successive switch points,

$$x_2(t + \tilde{t}) = x_2(0) \left[1 + \gamma + \tilde{\gamma} + O((t + \tilde{t})^2) \right].$$

Straightforward calculations using (12)–(13) and $\alpha_2\tilde{\alpha}_2 = x_3^2(0) - 1$ show that

$$t + \tilde{t} = \frac{4|\alpha_1|}{1 - x_3^2(0)} + O(\alpha_1^2). \quad (14)$$

Furthermore,

$$\begin{aligned} \gamma + \tilde{\gamma} &= \frac{4|\alpha_1|}{3(1 - x_3^2(0))^2} \\ &\quad \times \left[a_1(x_3^2(0) - 1) + b_1(x_3^2(0) + 1) - 2x_3(0)x_4(0) \right] + O(\alpha_1^2) \\ &= (t + \tilde{t}) \left[\frac{b_1 - a_1}{3} - \frac{1}{3} \cdot \frac{2x_3(0)(x_4(0) - b_1x_3(0))}{1 - x_3^2(0)} \right] + O(\alpha_1^2). \end{aligned}$$

This gives the differential equation associated with the peak values of the chattering variable $x_2(t)$ as

$$\dot{\bar{x}}_2(t) = \bar{x}_2(t) \left[\frac{b_1 - a_1}{3} - \frac{1}{3} \frac{2\bar{x}_3(t)(\bar{x}_4(t) - b_1\bar{x}_3(t))}{1 - \bar{x}_3^2(t)} \right],$$

where $(\bar{x}_i)_{i=3}^n = w$ is the solution to the sliding mode equation $\dot{w} = F_2w$ with F_2 given by (4). We have

$$\dot{\bar{x}}_3(t) = \bar{x}_4(t) - b_1\bar{x}_3(t).$$

Therefore, the associated differential equation can be rewritten as

$$\frac{d}{dt} \log(\bar{x}_2(t)) = \frac{b_1 - a_1}{3} + \frac{1}{3} \frac{d}{dt} \log(1 - \bar{x}_3^2(t)).$$

Integration of this equation leads to the formula for x_2 and the proof is completed. \square

Proof of Theorem 2: Introduce a slower time τ associated with the number of switches on a trajectory. The monotonous function $t = t(\tau)$ indicates the switch times with an integer argument: $t(k) = t_k$ is switch instant number k . Equation (14) in the proof of Theorem 1 states that the increments of this function can be approximated as

$$t(k+2) - t(k) = \frac{4|x_2(t(k))|}{1 - x_3^2(t(k))} + O\left(x_2^2(t(k))\right).$$

Because the increments are small as $x_2 \rightarrow 0$, the function $t(\tau)$ can be approximated by the solution of the differential equation

$$\frac{d}{d\tau} \bar{t}(\tau) = \frac{2|\bar{x}_2(\bar{t}(\tau))|}{1 - \bar{x}_3^2(\bar{t}(\tau))}.$$

The inverse function $\tau = \tau(t)$ satisfies

$$\frac{d}{d\bar{t}} \tau(\bar{t}) = \frac{1 - \bar{x}_3^2(\bar{t})}{2|\bar{x}_2(\bar{t})|}.$$

It remains now only to substitute \bar{x}_2 with the expression given in Theorem 1 and integrate over \bar{t} . \square

Proof of Theorem 3: Consider a simple symmetric limit cycle with sliding mode. Let its initial point be $x^0 = (0, 1, (z^0)^T)^T$ and let the sliding mode start in x^1 and end in $x^2 = -x^0$. Furthermore, let the sliding time and the smooth time be t_{sl} and t_{sm} , respectively. To derive the Jacobian W_1 , we study a trajectory starting in a perturbed initial point $x^0 + (0, 0, (\delta^0)^T)^T$. Let its next intersection with S be in $x^1 + \delta^1$ after time $t_{sm} + \delta_{sm}$. Taylor expansion gives

$$\delta^1 = e^{At_{sm}}(Ax^0 - B)\delta_{sm} + e^{At_{sm}}P_3^T\delta^0 + O(|(\delta_{sm}, \delta^0)|^2).$$

Because $C\delta^1 = 0$, we get asymptotically

$$(\delta_i^1)_{i=2}^n = P_2 \left(I - \frac{(Ax^1 - B)C}{C(Ax^1 - B)} \right) e^{At_{sm}} P_3^T \delta^0. \quad (15)$$

Consider the trajectory from $x^1 + \delta^1$ to $x^2 + \delta^2$ and let the time it takes be $t_{sl} + \delta_{sl}$. Then,

$$(\delta_i^2)_{i=2}^n = F_1 e^{F_1 t_{sl}} (x_i^1)_{i=2}^n \delta_{sl} + e^{F_1 t_{sl}} (\delta_i^1)_{i=2}^n + O(|(\delta_{sl}, \delta^1)|^2).$$

Because $e_1(\delta_i^2)_{i=2}^n = 0$, asymptotically

$$(\delta_i^2)_{i=3}^n = P_1 \left(I - \frac{F_1(1, (z^0)^T)^T e_1}{e_1 F_1(1, (z^0)^T)^T} \right) e^{F_1 t_{sl}}. \quad (16)$$

Equations (15) and (16) together with $\chi = (1, (z^0)^T)^T$ complete the proof. \square

The following lemma is used in the proof of Theorem 4.

LEMMA 2

Consider a sequence of stable state-space systems

$$\begin{aligned}\dot{x}^k &= Ax^k - B_2^k, \\ y^k &= Cx^k,\end{aligned}\tag{17}$$

where

$$B_2^k = \left(0 \quad 1 \quad b_1^k \quad \dots \quad b_{n-2}^k \right)^T$$

with b_i^k bounded and $b_i^k \rightarrow 0$ as $k \rightarrow \infty$ for $i = 1, \dots, n-2$, and $B_2^\infty = (0, 1, 0, \dots, 0)^T$. Let $x^k(0) = (0, 0, 1, z^T)^T$ be a fixed initial point and $\tau^k > 0$ equal the first time instant $x_1^k(t) = 0$ or infinity if this never occurs. If the first component of $e^{At}(0, 0, 0, z^T)^T$ is positive for all $t > 0$, then

$$e^{A\tau^k}(x^k(0) - A^{-1}B_2^k) \rightarrow 0 \quad \text{as } k \rightarrow \infty.$$

Proof: Because A is stable, the solution of (17) is

$$x^k(t) = e^{At}(x^k(0) - A^{-1}B_2^k) + A^{-1}B_2^k$$

with

$$A^{-1}B_2^k = \begin{pmatrix} 0 \\ 0 \\ 1 \\ \vdots \\ b_{n-3}^k \end{pmatrix} - \frac{b_{n-2}^k}{a_n} \begin{pmatrix} 1 \\ a_1 \\ a_2 \\ \vdots \\ a_{n-1} \end{pmatrix}$$

and

$$x^k(0) - A^{-1}B_2^k = \begin{pmatrix} 0 \\ 0 \\ 0 \\ z - (b_i^k)_{i=1}^{n-3} \end{pmatrix} + \frac{b_{n-2}^k}{a_n} \begin{pmatrix} 1 \\ a_1 \\ a_2 \\ \vdots \\ a_{n-1} \end{pmatrix} =: \psi^k + \frac{b_{n-2}^k}{a_n} \phi.$$

Thus, we have

$$\bar{\psi}_1^k(\tau^k) + \frac{b_{n-2}^k}{a_n} \left[\bar{\phi}_1(\tau^k) - 1 \right] = 0,\tag{18}$$

where $\bar{\psi}^k(t) = e^{At}\psi^k$ and $\bar{\phi}(t) = e^{At}\phi$. It follows from (18) and the assumption that the first component of $e^{At}(0, 0, 0, z^T)^T$ is positive that $\tau^\infty = \infty$. Moreover, due to that (17) is a stable linear system, $x^k(t)$ converges to $x^\infty(t)$ uniformly on $[0, \infty)$. Hence, $\tau^k \rightarrow \infty$ as $k \rightarrow \infty$ and the result follows. \square

Proof of Theorem 4: The first claim to prove is that the vector $y_{\text{sm}}(z^0)$ is sufficiently small. (We omit the argument z^0 in the sequel.) Consider the initial system with constant input $u = -1$. The entries b_1, \dots, b_{n-2} are small by the assumptions, because all zeros of $b(s)$ are close to the origin. The time $t_{\text{sm}} > 0$ is defined as the instant when $x_1(t) = 0$. It exists because $G(0) > 0$, see Remark 6. We have

$$x(t_{\text{sm}}) = e^{At_{\text{sm}}}(x(0) - A^{-1}B_2) + A^{-1}B_2.$$

Lemma 2 gives that

$$e^{At_{\text{sm}}}(x(0) - A^{-1}B_2) \rightarrow 0$$

as $b_i \rightarrow 0$ for all $i = 1, \dots, n - 2$. Moreover,

$$A^{-1}B_2 = \begin{pmatrix} 0 \\ 0 \\ 1 \\ \vdots \\ b_{n-3} \end{pmatrix} - \frac{b_{n-2}}{a_n} \begin{pmatrix} 1 \\ a_1 \\ a_2 \\ \vdots \\ a_{n-1} \end{pmatrix}.$$

Hence, y_{sm} is small if the zeros of $b(s)$ are close to the origin. The chattering thus appears close to the trajectory $x(t)$ with initial data $x(0) = (0, 0, 1, (z^0)^T)^T$.

The chattering is described by Theorem 1, because $x_2(t)$ is infinitely small as $b_i \rightarrow 0$ for all $i = 1, \dots, n - 2$. In particular, the chattering variables $x_1(t)$ and $x_2(t)$ decay exponentially and the peak values of $x_2(t)$ are proportional to $\exp[-(a_1 - b_1)t/3]$. Hence, we have a contraction of the chattering variables. Moreover, the time t_{sl} of the chattering mode tends to infinity as the zeros of $b(s)$ tend to the origin.

The smooth variables $(x_i)_{i=3}^n$ can be approximated during the chattering by the sliding mode $\dot{w} = F_2 w$, $w = (\bar{x}_i)_{i=3}^n$, where F_2 is given by (4). This trajectory is thus close to $Z_{\text{sl}}(t)$.

We have shown so far that the trajectory $x(t)$ of the relay feedback system which starts in $x(0) = (0, 0, 1, z^T)^T$ tends to the trajectory

$$\bar{x}(t) = \begin{cases} X_{\text{sm}}(t), & 0 \leq t \leq t_{\text{sm}}, \\ (0, 0, Z_{\text{sl}}(t)^T)^T, & t_{\text{sm}} < t \leq t_{\text{sm}} + t_{\text{sl}} \end{cases}$$

as the zeros of $b(s)$ tend to zero. In particular, the end point $x(t_{\text{sm}} + t_{\text{sl}})$ is close to the point $(0, 0, -Z(z^0)^T)^T$.

Finally, concerning stability of the limit cycle, we consider the Jacobian W_2 . By assumption, it defines a contraction in a neighborhood of z^0 , and by continuity it remains stable in some neighborhood of z^0 . For every $x = (x_1, x_2, z^T)^T$ with $|x_1|$, $|x_2|$, and $|z - z^0|$ small, define $f(x)$ as the final switch plane intersection of the chattering starting in x . Then the map f is a contraction

$$|f(x^1) - f(x^2)|_P \leq \gamma |x^1 - x^2|_P, \quad 0 < \gamma < 1,$$

with some appropriate metric P . Therefore the stationary point exists and is locally stable. \square

Proof of Lemma 1: Because all zeros of $b(s) = s^2 + b_1s + b_2$ are unstable, we have $b_1 < 0$. Condition 2 is obviously satisfied.

To check Condition 3, note that

$$x^0 = (0, 0, 0, x_4 - b_1)^T = (x_4 + |b_1|)(0, 0, 0, 1)^T$$

with $x_4 + |b_1| > 0$. The first entry of the vector $x(t) = e^{At}(0, 0, 0, 1)^T$ is the impulse response of a system with transfer function

$$\frac{1}{a(s)} = \frac{1}{(s + \lambda_1) \cdots (s + \lambda_4)},$$

where $-\lambda_i$ are the zeros of $a(s)$. The impulse response has the property

$$L^{-1}\{a^{-1}(s)\} = e^{-\lambda_1 t} * \cdots * e^{-\lambda_4 t} > 0,$$

where L^{-1} denotes the inverse Laplace transform and $*$ convolution. This completes the proof. \square

Paper 3

Performance Limitations in Multi-Loop Control Systems

Karl Henrik Johansson and Anders Rantzer

Abstract

Fundamental limitations in decentralized control design imposed by multivariable zeros are considered. It is shown that arbitrary bandwidth can be obtained with a stable block-diagonal controller, if certain subsystems of the open-loop system have no zeros in the right half-plane and a high-frequency condition holds. Implications on control structure design and sequential loop-closure methods are discussed.

1. Introduction

Industry faces a huge number of interacting control loops. The last three decades a variety of multivariable control design methods have been developed. Almost all of these are based on the assumption of a centralized control structure. However, for most industrial plants it is impossible to implement a centralized controller. Start-up schemes, identification experiments, and communication nets are only some issues that are considerable harder to face with centralized controllers than with decentralized, or multi-loop, controllers. Multi-loop control is the absolutely dominating structure in practice.

It is natural to look for fundamental limitations in a control system. In particular, this is motivated for multi-loop systems, because there is a great lack of theoretical results supporting control design methods for these systems. There exist formulas for performance limitations for centralized control systems. Extending results of Bode [Bode, 1945], implications of right half-plane (RHP) poles and zeros on achievable closed-loop performance for these systems are shown in [Zames, 1981; Zames and Francis, 1983; Holt and Morari, 1985; Freudenberg and Looze, 1988; Seron *et al.*, 1997]. For example, it is proved that for multivariable systems with no RHP zeros, the sensitivity function can be made arbitrarily small with a centralized controller.

Our main contribution is to connect multivariable zeros to closed-loop performance for multi-loop systems. Performance is measured through a weighted sensitivity function [Freudenberg and Looze, 1988; Zhou *et al.*, 1996]. *Sequentially minimum phase* is introduced as when the top left submatrices of the open-loop system are minimum phase. It is then shown that if an open-loop system is sequentially minimum phase and a condition on the relative degree of the subsystems holds, then the sensitivity can be arbitrarily reduced with a diagonal controller. An earlier sufficient condition for sensitivity reduction via multi-loop control was proved in [Zames and Bensoussan, 1983]. Their analysis was limited to systems diagonal at high frequencies, but other assumptions were weaker. Results on achievable performance for decentralized systems were also given in [Ünyelioğlu and Özgüner, 1994].

The outline of the paper is as follows. Notation and some preliminary results are given in Section 2. In Section 3 a new condition is presented for arbitrarily sensitivity reduction for systems with no RHP zeros under multi-loop control. For systems with RHP zeros an upper bound on the performance loss due to decentralization is shown in Section 4. Results on the connection between sequential control design and multivariable zeros are presented in Section 5. The concluding remarks in Section 6 cover connections to relative gain array analysis.

2. Preliminaries

Notation and some preliminary results are presented in this section.

Notation

Let the square transfer matrix G represent a system with equal number of inputs u_j and outputs y_i . The elements of G are denoted G_{ij} , $i, j = 1, \dots, m$, and can be scalar transfer functions as well as transfer matrices. We only consider proper G with full normal rank [Zhou *et al.*, 1996]. For the top left submatrix of G , the notation

$$G_k := \begin{pmatrix} G_{11} & \dots & G_{1k} \\ \vdots & & \vdots \\ G_{k1} & \dots & G_{kk} \end{pmatrix}$$

is used, and the first $k - 1$ elements of the last row and column of this matrix are denoted as

$$\begin{aligned} L_k &:= \begin{pmatrix} G_{k1} & \dots & G_{k,k-1} \end{pmatrix}, \\ R_k &:= \begin{pmatrix} G_{1k} & \dots & G_{k-1,k} \end{pmatrix}, \end{aligned} \tag{1}$$

respectively. We consider a block diagonal control law $u = -Cy$, where $C = \text{diag}\{C_1, \dots, C_m\}$ and C_i is a transfer matrix of dimension one or higher, corresponding to the size of G_{ii} .

Our main result concerns stable systems. Therefore, recall that a stable open-loop system G remains stable after interconnection with feedback controller C , if and only if $C(I + GC)^{-1}$ is stable and the closed-loop system is well-posed, that is, $I + C(\infty)G(\infty)$ is nonsingular [Zhou *et al.*, 1996, page 119]. The sensitivity function is defined as

$$S := (I + GC)^{-1}$$

and for the subsystems we use the notation

$$S_k := (I + G_k \bar{C}_k)^{-1},$$

where $\bar{C}_k := \text{diag}\{C_1, \dots, C_k\}$. We only need the simplest definition of a multivariable right half-plane (RHP) zero.

DEFINITION 1

A *RHP zero* of a stable transfer matrix G is a point z in the closed right half-plane for which $\text{rank } G(z)$ is smaller than the normal rank of G . \square

If a transfer matrix does not have any RHP zeros it is called minimum phase and otherwise nonminimum phase. The norm $\|A\|$ of a matrix A is its largest singular value and for transfer matrices we define

$$\|G\|_{\infty} := \sup_{\text{Re } s \geq 0} \|G(s)\|.$$

Background

Frequency-weighted sensitivity functions are widely used in practice; for example, loop-shaping is often done based on shaping the sensitivity and complementary sensitivity functions [Freudenberg and Looze, 1988; Zhou *et al.*, 1996]. In control design, the weights are chosen to reflect frequency contents in, for example, disturbances and perturbations. Closed-loop performance limitations have been quantified in terms of weighted sensitivity functions in [Zames, 1981; Zames and Bensoussan, 1983; Zames and Francis, 1983]. This will also be the framework for our analysis.

Recall the Youla parameterization [Francis, 1987].

LEMMA 1

Let G be a stable transfer matrix. All proper stabilizing controllers are given as

$$C = (I - QG)^{-1}Q = Q(I - GQ)^{-1},$$

where Q is a proper stable transfer matrix. \square

The following lemma is a slight variation of Corollary 6.2 in [Zames, 1981].

LEMMA 2

Consider a stable transfer matrix G with no RHP zeros and a strictly proper stable transfer function W with no RHP zeros. For every $\varepsilon > 0$ there exists a strictly proper stabilizing and stable (centralized) controller C such that

$$\|W(I + GC)^{-1}\|_{\infty} < \varepsilon$$

and $\|W^{-1}C\|_{\infty}$ is bounded.

Proof: Let d be a positive integer such that $[s^d W(s)G(s)]^{-1}$ is proper. Consider

$$\widehat{C}(s) = \frac{G^{-1}(s)}{(1 + \tau s)^d - 1},$$

where $\tau > 0$ is chosen such that

$$\|W(I + G\widehat{C})^{-1}\|_{\infty} = \left\| W(s) \frac{(1 + \tau s)^d - 1}{(1 + \tau s)^d} \right\|_{\infty} < \varepsilon.$$

The closed-loop system has all poles in $-\tau$ and \widehat{C} has all poles uniformly distributed on a circle intersecting the origin and $-2/\tau$. In order to get a stable controller let

$$C(s) = \frac{G^{-1}(s)}{(1 + \tau s)^d - 1 + \delta}.$$

For $\delta > 0$ sufficiently small, it follows by continuity that the closed-loop system is stable,

$$\|W(I + GC)^{-1}\|_{\infty} = \left\| W(s) \frac{(1 + \tau s)^d - 1 + \delta}{(1 + \tau s)^d + \delta} \right\|_{\infty} < \varepsilon,$$

and that C has all poles in the open left half-plane. The proof is complete because $W^{-1}C$ is stable and proper. \square

Lemma 2 should be considered together with the lower bound on sensitivity reduction given as Theorem 4 in [Zames, 1981], which is restated next.

PROPOSITION 1

Consider a stable transfer matrix G with RHP zeros in $z_i, i = 1, \dots, \ell$, and a proper stable transfer function W with no RHP zeros. Then for every proper stabilizing controller C

$$\|W(I + GC)^{-1}\|_{\infty} \geq \max_{i \in \{1, \dots, \ell\}} |W(z_i)|.$$

\square

Proposition 1 provides a lower bound for multi-loop control of systems with RHP zeros. No controller can give a tight feedback if a RHP zero of G is located in a heavily weighted part of the right half-plane.

3. **Sequentially Minimum Phase**

This section is devoted to a new theorem on minimization of the sensitivity function under multi-loop control. The theorem is proved using sequential control design. It turns out that certain submatrices of G should be minimum phase.

DEFINITION 2

A stable transfer function matrix G is *sequentially minimum phase* if G_1, \dots, G_m have full normal rank and no RHP zeros. \square

Under the assumption that G_{k-1} , $k \in \{2, \dots, m\}$, has no RHP zeros and W is a proper stable transfer function with no RHP zeros, introduce the scalar $\phi_k(W) \in [0, \infty]$ as

$$\phi_k(W) := \|W^{-1}L_k G_{k-1}^{-1}\|_\infty,$$

where L_k is given by (1).

EXAMPLE 1

The transfer matrix

$$G(s) = \begin{pmatrix} \frac{1}{s+1} & \frac{1}{s+1} \\ \frac{1}{(s+2)^2} & \frac{1}{(s+1)^2} \end{pmatrix}$$

is sequentially minimum phase, because $G_1(s) = (s+1)^{-1}$ and $G_2(s) = G(s)$ have no RHP zeros. Furthermore, $\phi_2(W)$ is bounded for all weighting functions of relative degree less than two, because

$$\phi_2(W) = \|W^{-1}G_{21}G_{11}^{-1}\|_\infty = \left\| W^{-1}(s) \frac{s+1}{(s+2)^2} \right\|_\infty < \infty.$$

\square

A symmetric definition of $\phi_k(W)$ including R_k instead of L_k arises in a natural way, if the input sensitivity function $S_i = (I + CG)^{-1}$ is studied instead of the output sensitivity function $S_o = (I + GC)^{-1}$. See [Freudenberg and Looze, 1988] and [Zhou *et al.*, 1996] for interpretations of S_i and S_o . Next we state our main result.

THEOREM 1

Consider a stable transfer matrix G and a strictly proper stable transfer function W with no RHP zeros. If G is sequentially minimum phase and $\phi_k(W)$ is bounded for $k = 2, \dots, m$, then for every $\varepsilon > 0$ there exists a strictly proper stabilizing and stable controller $C = \text{diag}\{C_1, \dots, C_m\}$ such that

$$\|W(I + GC)^{-1}\|_\infty < \varepsilon.$$

Proof: See Appendix. \square

REMARK 1 Note that if G_k for $k < m$ has a RHP zero, then after permutation of inputs and outputs (the new) G_1, \dots, G_m do not necessarily have any RHP zeros. An obvious algorithm for control structure design can be derived, where the inputs and outputs are permuted until a suitable sequence G_1, \dots, G_m is found. During the search, the structure of the controller may change in the sense that the dimensions of C_1, \dots, C_m may vary, and thus the number of blocks m . A centralized controller corresponds to $m = 1$, in which case Theorem 1 corresponds to Lemma 2 in Section 2 and Corollary 6.2 in [Zames, 1981].

REMARK 2 The condition on $\phi_k(W)$ being bounded has a natural connection to engineering practice. In multi-loop design it is often preferable to close the fastest loops first. Consider, for example, a system with two scalar inputs and two scalar outputs and a weighting function $W(s) = a(s + a)^{-1}$, $a > 0$. Then G is sequentially minimum phase if G_{11} has relative degree smaller than G_{21} , that is, G_{11} is faster than G_{21} in the sense that G_{21} suppresses high-frequency signals better than G_{11} . Compare with Example 1.

REMARK 3 A similar statement for systems being diagonal at high frequencies is proved in [Zames and Bensoussan, 1983]. Then there is no requirements on the zeros of G_1, \dots, G_{m-1} or on $\phi_k(W)$. The system in Example 1 satisfies the assumptions of Theorem 1, but is not ultimately diagonally dominant. Decentralized two-by-two controllers that minimize $\|S_1(i\omega)\|$ are considered in [Ünyeliöglu and Özgüner, 1994].

Control design was analyzed in [O'Reilly and Leithead, 1991] for the system in the following example.

EXAMPLE 2—AUTOMOTIVE GAS TURBINE

The estimated model for the automotive gas turbine in [Winterbone *et al.*, 1973] is given by

$$G(s) = \begin{pmatrix} \frac{130 \times 10^4 s + 33600 \times 10^4}{s^2 + 392s + 13900} & -\frac{5.6s^2 + 246s + 744}{s^2 + 28.9s + 24.6} \\ \frac{904 \times 10^4 s + 28400 \times 10^4}{s^3 + 233s^2 + 8610s + 11900} & \frac{83.4s + 6300}{s^2 + 115s + 195} \end{pmatrix}.$$

The inputs are fuel mass flow and nozzle flow area, and the outputs are turbine inlet temperature and gas generator speed. The system G has no RHP poles or zeros. The zero of G_{11} is also stable and, furthermore, $\phi_2(W)$ is bounded for all weighting functions W of relative degree one.

Hence, the sensitivity function can be made arbitrarily small in the sense of Theorem 1. \square

If a system fulfills the assumptions in Theorem 1, theoretically a multi-loop controller can give arbitrarily tight control. In practice, however, the region in which the model is accurate gives the performance limitations. Hence, fulfilled assumptions imply that effort should be put into investigations of nonlinearities, such as actuator limitations, and unmodeled high-frequency dynamics.

4. Right Half-Plane Zeros

It is well-known that RHP zeros impose restrictions on the achievable closed-loop performance. Proposition 1 in Section 2 gave an interpretation of these restrictions in achievable sensitivity reduction. This section presents a result on how close to the estimate for centralized control systems in Proposition 1 we can get with a decentralized design.

Consider a partially closed system having the first $k - 1$ loops closed and the last $m - k + 1$ loops open. Let the controller be

$$\bar{C}_{k-1} = \text{diag}\{C_1, \dots, C_{k-1}\}$$

and suppose it stabilizes G_{k-1} . Introduce $H_k = H_k(C_1, \dots, C_{k-1})$ as the transfer matrix between u_k and y_k for this partially closed system. We define $H_1 := G_{11}$ and for $k = 2, \dots, m$ it follows that

$$H_k = G_{kk} - L_k \bar{C}_{k-1} S_{k-1} R_k^T. \quad (2)$$

(The argument of H_k showing the dependency of the controller is omitted for convenience.) Note that $\bar{C}_{k-1} S_{k-1}$ is stable because the partially closed system is stable, and thus H_k is stable if G is stable. It is easy to show that if G_{k-1} is nonsingular, then

$$H_k = G_{kk} - L_k G_{k-1}^{-1} (I - S_{k-1}) R_k^T, \quad k = 2, \dots, m. \quad (3)$$

We also use the notation

$$\hat{H}_k := G_{kk} - L_k G_{k-1}^{-1} R_k^T, \quad k = 2, \dots, m. \quad (4)$$

Note that \hat{H}_k is not necessarily proper and that \hat{H}_k does not depend on the controller C .

Next we combine Proposition 1 with the idea of Theorem 1 to state a result that gives an upper bound on the minimal weighted sensitivity for a decentralized control system with open-loop RHP zeros.

THEOREM 2

Consider a stable transfer matrix G and a strictly proper stable transfer function W with no RHP zeros. If G_{m-1} is sequentially minimum phase, $\phi_k(W)$ is bounded for $k = 2, \dots, m$, and C_m is strictly proper and stabilizes \hat{H}_m with $\|W^{-1}C_m\|_\infty$ bounded, then for every $\delta > 0$ there exists a strictly proper stabilizing controller $C = \text{diag}\{C_1, \dots, C_m\}$ such that

$$\|W(I + GC)^{-1}\|_\infty < \|W(I + \hat{H}_m C_m)^{-1}\|_\infty (1 + \phi_m(W)\|W\|_\infty) + \delta.$$

Proof: See Appendix. □

REMARK 4 Lemma 4 in Section 5 implies that \hat{H}_m has the same RHP zeros as G . The limitations imposed by \hat{H}_m are in this sense similar to the limitations faced at a centralized control design for G . Theorem 2 gives a connection between sensitivity reduction using decentralized and centralized control for some open-loop systems that have RHP zeros.

REMARK 5 If $L_m = 0$, which for example holds when G is upper triangular, then $\|WS\|_\infty < \|W(I + \hat{H}_m C_m)^{-1}\|_\infty + \delta$. Decentralization impose, of course, no extra limitations on the sensitivity reduction in this case.

5. Zeros and Sequential Loop-Closure

Closing one control loop at a time is for many practical reasons the dominating way of designing control systems in industry. There exist, however, only few systematic design methods based on such a sequential loop-closure [Mayne, 1979; Bryant and Yeung, 1996]. From a theoretical point of view, this kind of approach have several limitations compared to an approach with all loops closed simultaneously. Nevertheless, it is interesting to quantify the fundamental properties of the sequential method. In this section results on the connection between sequential loop-closure design and multivariable zeros are derived.

A key result for sequentially closed loops is the following simple fact.

LEMMA 3

Consider a stable transfer matrix G . If $C_k(I + H_k C_k)^{-1}$, with H_k defined in (2), is stable for all $k = 1, \dots, m$, then $C = \text{diag}\{C_1, \dots, C_m\}$ stabilizes G .

Proof: Let $\bar{C}_k = \text{diag}\{C_1, \dots, C_k\}$. Application of

$$\begin{pmatrix} A & B \\ C & D \end{pmatrix}^{-1} = \begin{pmatrix} A^{-1} & 0 \\ 0 & 0 \end{pmatrix} + \begin{pmatrix} A^{-1}B \\ -I \end{pmatrix} (D - CA^{-1}B)^{-1} \begin{pmatrix} CA^{-1} & -I \end{pmatrix} \quad (5)$$

gives, with appropriate matrix partitioning and the assumption that all inverses exist,

$$\begin{aligned} \bar{C}_k(I + G_k\bar{C}_k)^{-1} &= \begin{pmatrix} \bar{C}_{k-1} & 0 \\ 0 & C_k \end{pmatrix} \begin{pmatrix} I + G_{k-1}\bar{C}_{k-1} & R_k^T C_k \\ L_k \bar{C}_{k-1} & I + G_{kk} C_k \end{pmatrix}^{-1} \\ &= \begin{pmatrix} \bar{C}_{k-1}(I + G_{k-1}\bar{C}_{k-1})^{-1} & 0 \\ 0 & 0 \end{pmatrix} \\ &\quad + \begin{pmatrix} \bar{C}_{k-1}(I + G_{k-1}\bar{C}_{k-1})^{-1} R_k^T \\ -I \end{pmatrix} C_k (I + H_k C_k)^{-1} \\ &\quad \times \begin{pmatrix} L_k \bar{C}_{k-1} (I + G_{k-1} \bar{C}_{k-1})^{-1} & -I \end{pmatrix}. \end{aligned}$$

Hence, if $C_k(I + H_k C_k)^{-1}$ and $\bar{C}_{k-1}(I + G_{k-1}\bar{C}_{k-1})^{-1}$ are stable, then $\bar{C}_k(I + G_k\bar{C}_k)^{-1}$ is stable. Because $\bar{C}_1(I + G_1\bar{C}_1)^{-1} = C_1(I + H_1 C_1)^{-1}$ and $C_k(I + H_k C_k)^{-1}$ is stable for all $k = 1, \dots, m$, mathematical induction proves the result. Well-posedness follows similarly. \square

REMARK 6 The single condition that $C_k(I + H_k C_k)^{-1}$ is stable does not imply that the whole closed-loop system is stable after k loops closed. The opposite is, of course, true: If the system is stable after k loops closed, then $C_k(I + H_k C_k)^{-1}$ is stable because

$$\begin{pmatrix} 0 & I \end{pmatrix} \bar{C}_k (I + G_k \bar{C}_k)^{-1} \begin{pmatrix} 0 \\ I \end{pmatrix} = C_k (I + H_k C_k)^{-1}.$$

The following result is a slight generalization of Theorem 5.2.7 in [Rosenbrock, 1970].

LEMMA 4

Consider a transfer matrix G and let $k \in \{2, \dots, m\}$. If loops 1 to $k-1$ are closed such that $S_{k-1}(s_0) = 0$ for some $s_0 \in \mathbf{C}$ and $G_{k-1}(s_0)$ is nonsingular, then

$$\det H_k(s_0) = \frac{\det G_k(s_0)}{\det G_{k-1}(s_0)}.$$

Proof: Equation (3) with $S_{k-1}(s_0) = 0$ gives

$$\det H_k(s_0) = \det(G_{kk} - L_k G_{k-1}^{-1} R_k^T)(s_0).$$

The equation

$$\det \begin{pmatrix} A & B \\ C & D \end{pmatrix} = \det A \det(D - CA^{-1}B)$$

applied to

$$G_k = \begin{pmatrix} G_{k-1} & R_k^T \\ L_k & G_{kk} \end{pmatrix}$$

then leads to

$$\det G_k(s_0) = \det G_{k-1}(s_0) \det H_k(s_0),$$

which gives the result. \square

Lemma 4 relates zeros of the subsystem G_k to zeros in loop k . Hence, if all loops but one have tight control, the achievable performance in that loop will be given by the zeros of G . This consequence was exposed in Theorem 2. A result similar to Lemma 4 holds even if we only know that $S_{k-1}(s_0)$ is small.

THEOREM 3

Consider a transfer matrix G . Let $k \in \{2, \dots, m\}$ and $s_0 \in \mathbf{C}$. If $G_k(s_0)$ is nonsingular and loops 1 to $k-1$ are closed such that

$$\|S_{k-1}(s_0)\| \cdot \|G_k(s_0)\| \cdot \|G_k^{-1}(s_0)\| < 1,$$

then

$$\|H_k^{-1}(s_0)\| < \frac{\|G_k^{-1}(s_0)\|}{1 - \|S_{k-1}(s_0)\| \cdot \|G_k(s_0)\| \cdot \|G_k^{-1}(s_0)\|}.$$

Proof: Introduce the matrix

$$\Gamma_k := \begin{pmatrix} G_{k-1} & (I - S_{k-1})R_k^T \\ L_k & G_{kk} \end{pmatrix}.$$

Then

$$\begin{aligned} \Gamma_k^{-1}(s_0) &= \left(G_k - \begin{pmatrix} 0 & S_{k-1}R_k^T \\ 0 & 0 \end{pmatrix} \right)^{-1} (s_0) \\ &= G_k^{-1} \left(I - \begin{pmatrix} 0 & S_{k-1}R_k^T \\ 0 & 0 \end{pmatrix} G_k^{-1} \right)^{-1} (s_0). \end{aligned}$$

Recall that $\|F\| < 1$ implies $\|(I - F)^{-1}\| \leq (1 - \|F\|)^{-1}$. Hence, because

$$\|S_{k-1}R_k^T\| \cdot \|G_k^{-1}\| \leq \|S_{k-1}\| \cdot \|G_k\| \cdot \|G_k^{-1}\| < 1,$$

we have

$$\|\Gamma_k^{-1}(s_0)\| < \frac{\|G_k^{-1}(s_0)\|}{1 - \|S_{k-1}(s_0)\| \cdot \|G_k(s_0)\| \cdot \|G_k^{-1}(s_0)\|}.$$

Applying the estimate

$$\left\| \begin{pmatrix} A & B \\ C & D \end{pmatrix}^{-1} \right\| \geq \|(D - CA^{-1}B)^{-1}\|$$

to Γ_k^{-1} gives $\|\Gamma_k^{-1}(s_0)\| \geq \|H_k^{-1}(s_0)\|$, which completes the proof. \square

Theorem 3 states that if neither G_k lose rank in s_0 , nor does H_k provided that the feedback of the subsystem G_{k-1} is sufficiently tight and G_k is bounded. Note that the assumption $\|S_{k-1}\| \cdot \|G_k\| \cdot \|G_k^{-1}\| < 1$ is equivalent to that $\|S_{k-1}\| < 1/\kappa(G_k)$, where $\kappa(G_k) := \|G_k\| \cdot \|G_k^{-1}\|$ is the condition number, well-known as a measure of how close a matrix is to singularity. The condition number of the open-loop system $\kappa(G)$ is suggested for plant assessment and for choosing input–output pairing in [Morari and Zafiriou, 1989].

6. Conclusions

New results on performance limitation of multi-loop control systems have been presented. *Sequentially minimum phase* was introduced as when the top left submatrices of the open-loop system are minimum phase. The main theorem said that for stable systems any bandwidth is achievable with multi-loop control, provided that the system is sequentially minimum phase and a condition on the relative degree of the subsystems holds. The zeros of G_1, \dots, G_{m-1} can be seen as the the cost of choosing a certain control structure, and, hence, give suggestions for solutions to the control structure design problem. There exist only few systematic methods to compare decentralized and centralized control structures. Our result give suggestions on how to derive such a method, where the zeros of the subsystems of G should be considered. Another recent method is given in [Freudenberg and Middleton, 1996]. RHP zeros of open-loop subsystems also set constraints for stabilization of unstable plants [Davison and Wang, 1985].

The transfer matrices H_k and \hat{H}_k arising in the preceding analysis have connections to the relative gain array (RGA). The RGA was introduced by Bristol [Bristol, 1966] and is today a standard tool for interaction analysis in chemical process control [Morari and Zafiriou, 1989]. For simplicity, consider a system with two inputs and two outputs. Then the dynamic RGA is represented by the transfer function

$$\lambda := \frac{G_{11}G_{22}}{G_{11}G_{22} - G_{12}G_{21}}.$$

It follows from (4) that $\lambda = G_{22}/\hat{H}_2$. Hence, the RGA can be interpreted as the fraction between G_{22} and H_2 under infinitely tight feedback in loop one. Theorem 1 provides a sufficient condition for applicability of RGA analysis. Note, however, that Proposition 1 suggests that if there exist RHP zeros close to the imaginary axis, the RGA analysis might be less appropriate.

7. References

- BODE, H. W. (1945): *Network Analysis and Feedback Amplifier Design*. Van Nostrand, New York, NY.
- BRISTOL, E. (1966): "On a new measure of interaction for multivariable process control." *IEEE Transactions on Automatic Control*, **11**, p. 133.
- BRYANT, G. F. and L. F. YEUNG (1996): *Multivariable Control System Design Techniques: Dominance and Direct Methods*. Wiley.
- DAVISON, E. J. and S. H. WANG (1985): "A characterization of decentralized fixed modes in terms of transmission zeros." *IEEE Transactions on Automatic Control*, **30:1**, pp. 81–82.
- FRANCIS, B. A. (1987): *A Course in H_∞ Control Theory*. Springer-Verlag, Berlin, Germany.
- FREUDENBERG, J. and D. LOOZE (1988): *Frequency Domain Properties of Scalar and Multivariable Feedback Systems*. Springer-Verlag, Berlin, Germany.
- FREUDENBERG, J. and R. MIDDLETON (1996): "Design rules for multivariable feedback systems." In *35th IEEE Conference on Decision and Control*, pp. 1980–1985. Kobe, Japan.
- HOLT, B. R. and M. MORARI (1985): "Design of resilient processing plants—VI. The effect of right-half-plane zeros on dynamic resilience." *Chemical Engineering Science*, **40:1**, pp. 59–74.

- MAYNE, D. Q. (1979): "Sequential design of linear multivariable systems." *Proc. IEE*, **126:6**, pp. 568–572.
- MORARI, M. and E. ZAFIRIOU (1989): *Robust Process Control*. Prentice-Hall, Englewood Cliffs, NJ.
- O'REILLY, J. and W. E. LEITHEAD (1991): "Multivariable control by 'individual channel design.'" *International Journal of Control*, **54:1**, pp. 1–46.
- ROSENBROCK, H. H. (1970): *State-Space and Multivariable Theory*. Nelson, London, U.K.
- SERON, M. M., J. H. BRASLAVSKY, and G. C. GOODWIN (1997): *Fundamental Limitations in Filtering and Control*. Springer-Verlag.
- ÜNYELIOĞLU, K. and Ü. ÖZGÜNER (1994): " H_∞ sensitivity minimization using decentralized feedback: 2-input 2-output systems." *Systems & Control Letters*, **22**, pp. 99–109.
- WINTERBONE, D. E., N. MUNRO, and P. M. G. LOURTIE (1973): "A preliminary study of the design of a controller for an automotive gas turbine." *Journal of Engineering for Power*, **95**, pp. 244–250.
- ZAMES, G. (1981): "Feedback and optimal sensitivity: Model reference transformations, multiplicative seminorms and approximate inverses." *IEEE Transactions on Automatic Control*, **AC-26**, pp. 301–320.
- ZAMES, G. and D. BENSOUSSAN (1983): "Multivariable feedback, sensitivity, and decentralized control." *IEEE Transactions on Automatic Control*, **28:11**, pp. 1030–1035.
- ZAMES, G. and B. A. FRANCIS (1983): "Feedback, minimax sensitivity, and optimal robustness." *IEEE Transactions on Automatic Control*, **28:5**, pp. 585–601.
- ZHOU, K., J. C. DOYLE, and K. GLOVER (1996): *Robust and Optimal Control*. Prentice Hall.

Appendix

Theorems 1 and 2 are proved in this appendix. Notations and results from Sections 4 and 5 as well as the following two lemmas are used in the proofs.

LEMMA 5

Let $k \in \{2, \dots, m\}$ and suppose $I + H_k C_k$ is nonsingular. Then

$$S_k = \begin{pmatrix} S_{k-1} & 0 \\ 0 & 0 \end{pmatrix} + \begin{pmatrix} S_{k-1} R_k^T C_k \\ -I \end{pmatrix} (I + H_k C_k)^{-1} \begin{pmatrix} L_k \bar{C}_{k-1} S_{k-1} & -I \end{pmatrix}.$$

Proof: The equality follows from the matrix equation (5) applied to

$$S_k = (I + G_k \bar{C}_k)^{-1} = \left(\begin{array}{c|c} S_{k-1}^{-1} & R_k^T C_k \\ \hline L_k \bar{C}_{k-1} & I + G_{kk} C_k \end{array} \right)^{-1}$$

using

$$I + H_k C_k = I + G_{kk} C_k - L_k \bar{C}_{k-1} S_{k-1} R_k^T C_k.$$

□

LEMMA 6

Consider a stable transfer matrix G_k and a strictly proper stable transfer function W with no RHP zeros. Assume G_k is sequentially minimum phase, $\phi_\ell(W)$ is bounded for $\ell = 2, \dots, k$, and that \bar{C}_{k-1} stabilizes G_{k-1} . Let C_k be given as $C_k = (I - Q \hat{H}_k)^{-1} Q$ with Q proper and stable, \hat{H}_k be defined by (4), and $\|W^{-1} C_k\|_\infty$ be bounded. If $\|W S_{k-1}\|_\infty$ is sufficiently small, then \bar{C}_k stabilizes G_k and

$$\begin{aligned} \|W S_k\|_\infty &\leq \|W S_{k-1}\|_\infty + (1 + \|W S_{k-1}\|_\infty \cdot \|G\|_\infty \cdot \|W^{-1} C_k\|_\infty) \\ &\quad \times \|W(I + \hat{H}_k C_k)^{-1}\|_\infty (1 - \phi_k(W) \|W S_{k-1}\|_\infty \cdot \|Q\|_\infty)^{-1} \\ &\quad \times [1 + \phi_k(W) (\|W\|_\infty + \|W S_{k-1}\|_\infty)]. \end{aligned}$$

Proof: We start by showing closed-loop stability. Note that

$$H_k - \hat{H}_k = L_k G_{k-1}^{-1} S_{k-1} R_k^T$$

is stable and that

$$\begin{aligned} \|L_k G_{k-1}^{-1} S_{k-1} R_k^T\|_\infty &= \|W^{-1} L_k G_{k-1}^{-1} W S_{k-1} R_k^T\|_\infty \\ &\leq \phi_k(W) \cdot \|W S_{k-1}\|_\infty \cdot \|G\|_\infty < \infty. \end{aligned}$$

Because H_k is proper, this gives that \hat{H}_k is proper. Hence, $C_k(I + H_k C_k)^{-1}$ is stable for all $\|W S_{k-1}\|_\infty$ sufficiently small, because $Q = C_k(I + \hat{H}_k C_k)^{-1}$ is stable.¹ Closed-loop stability follows from Lemma 3.

¹A crucial point here and in the remaining part of the proof is that G_{k-1} has no RHP zeros. If G_{k-1} has a RHP zero, then there does not exist any stabilizing controller \bar{C}_{k-1} such that $\|W S_{k-1}\|_\infty$ is arbitrarily small, see Proposition 1.

From Lemma 5 we then have that

$$\begin{aligned} \|WS_k\|_\infty &\leq \|WS_{k-1}\|_\infty + (1 + \|S_{k-1}R_k^T C_k\|_\infty) \\ &\quad \times \|W(I + H_k C_k)^{-1}\|_\infty (1 + \|L_k \bar{C}_{k-1} S_{k-1}\|_\infty). \end{aligned} \quad (6)$$

Each of the right-hand side expressions of (6) is estimated next. First,

$$\|S_{k-1}R_k^T C_k\|_\infty \leq \|WS_{k-1}\|_\infty \cdot \|G\|_\infty \cdot \|W^{-1}C_k\|_\infty.$$

Second,

$$\begin{aligned} \|W(I + H_k C_k)^{-1}\|_\infty &= \|W(I - \hat{H}_k Q)(I - (\hat{H}_k - H_k)Q)^{-1}\|_\infty \\ &\leq \|W(I + \hat{H}_k C_k)^{-1}\|_\infty (1 - \|L_k G_{k-1}^{-1} S_{k-1} R_k^T Q\|_\infty)^{-1} \\ &\leq \|W(I + \hat{H}_k C_k)^{-1}\|_\infty (1 - \phi_k(W) \cdot \|WS_{k-1}\|_\infty \cdot \|Q\|_\infty)^{-1}, \end{aligned}$$

if $\|WS_{k-1}\|_\infty$ is sufficiently small. Finally, for the last expression of (6) we have

$$\begin{aligned} \|L_k \bar{C}_{k-1} S_{k-1}\|_\infty &\leq \|W^{-1}L_k G_{k-1}^{-1}\|_\infty \cdot \|W G_{k-1} \bar{C}_{k-1} S_{k-1}\|_\infty \\ &= \phi_k(W) \|W(I - S_{k-1})\|_\infty \\ &\leq \phi_k(W) (\|W\|_\infty + \|WS_{k-1}\|_\infty). \end{aligned}$$

□

Proof of Theorem 1: We prove by mathematical induction that for every ε_ℓ , $\ell \in \{1, \dots, m\}$, there exists a strictly proper stabilizing and stable controller $\bar{C}_\ell = \text{diag}\{C_1, \dots, C_\ell\}$ such that

$$\|W(I + G_\ell \bar{C}_\ell)^{-1}\|_\infty < \varepsilon_\ell. \quad (7)$$

Lemma 2 gives that this is true for $\ell = 1$. Suppose it holds also for $\ell = 2, \dots, k-1$. From the assumptions and Lemma 4 it follows that \hat{H}_k has no RHP zeros. Lemma 2 gives that for every $\delta_k > 0$ there exists a strictly proper and stable C_k such that $C_k(I + \hat{H}_k C_k)^{-1}$ is stable, $\|W^{-1}C_k\|_\infty$ bounded, and

$$\|W(I + \hat{H}_k C_k)^{-1}\|_\infty < \delta_k.$$

Hence, by first choosing $\delta_k > 0$ and then $\varepsilon_{k-1} > 0$ sufficiently small, we obtain from Lemma 6 that for every $\varepsilon_k > 0$ there exists a stabilizing and stable controller \bar{C}_k such that $\|WS_k\|_\infty < \varepsilon_k$. The induction completes the proof. □

Proof of Theorem 2: Lemma 4 gives that \widehat{H}_m is stable. Because $\phi_m(W)$ is bounded, we get as in the proof of Theorem 1 that \widehat{H}_m is proper. It is thus no restriction to assume that $C_m = Q(I - \widehat{H}_m Q)^{-1}$, where Q is proper and stable. Theorem 1 gives that for every $\varepsilon > 0$ there exists a strictly proper controller $\widetilde{C}_{m-1} = \text{diag}\{C_1, \dots, C_{m-1}\}$ stabilizing G_{m-1} such that $\|WS_{m-1}\|_\infty < \varepsilon$. From Lemma 6 we get

$$\begin{aligned} \|WS\|_\infty &\leq \varepsilon + (1 + \varepsilon\|G\|_\infty \cdot \|W^{-1}C_m\|_\infty) \|W(I + \widehat{H}_m C_m)^{-1}\|_\infty \\ &\quad \times (1 - \phi_m(W)\varepsilon\|Q\|_\infty)^{-1} [1 + \phi_m(W)(\|W\|_\infty + \varepsilon)] \\ &\leq \|W(I + \widehat{H}_m C_m)^{-1}\|_\infty (1 + \phi_m(W)\|W\|_\infty) + \delta(\varepsilon), \end{aligned}$$

where $\delta(\varepsilon) \rightarrow 0$ as $\varepsilon \rightarrow 0$. Closed-loop stability follows from Lemma 3. \square

Paper 4

A Multivariable Process with an Adjustable Zero

Karl Henrik Johansson and José Luís Rocha Nunes

Abstract

A novel multivariable laboratory process that consists of four interconnected water tanks is presented. The linearized dynamics of the system have a multivariable zero that is possible to move along the real axis by changing a valve. The zero can be placed in both the left and the right half-plane. In this way the quadruple-tank process is ideal for illustrating many concepts in multivariable control, particularly performance limitations due to multivariable right half-plane zeros. Accurate models are derived from both physical and experimental data and multi-loop control is illustrated.

1. Introduction

There is an increased industrial interest in the use of multivariable control techniques. They are needed to achieve improved performance of complex industrial processes [Shinskey, 1981]. Therefore, it is important to include multivariable methods in the control curriculum. Of course, true understanding and engineering skills are only obtained if these concepts are illustrated in laboratory exercises. However, few multivariable laboratory processes have been reported in the literature. Mechanical systems such as the helicopter model [Mansour and Schaufelberger, 1989; Åkesson *et al.*, 1996] and the active magnetic bearing process [Vischer and Bleuler, 1990] have been developed at ETH in Zürich. Davison has developed a water tank process, where multivariable water level control and temperature–flow control can be investigated [Davison, 1985]. Some multivariable laboratory processes are commercially available, for example from Quanser Consulting in Canada, Educational Control Products in U.S., and Feedback Instruments and TecQuipment in U.K.

This paper describes a new laboratory process that consists of four interconnected water tanks and two pumps. The system is shown in Figure 1. Its inputs are the voltages to the two pumps and the outputs are the water levels in the lower two tanks. This quadruple-tank process is a simple interconnection of two double-tank processes, which are standard processes in many control laboratories [Åström and Östberg, 1986; Åström and Lundh, 1992]. The setup is thus simple, but still the process can illustrate interesting multivariable phenomena. The linearized model of the quadruple-tank process has a multivariable zero, which can be located in either the left or the right half-plane by simply changing a valve. Control performance limitations due to zero locations can be derived from complex analysis [Freudenberg and Looze, 1988; Seron *et al.*, 1997]. These illustrate fundamental restrictions on the possible choice of closed-loop system. For example, right half-plane zeros impose restrictions on the sensitivity function: if the sensitivity is forced to be small in one frequency band, it has to be large in another, possibly yielding an overall bad performance. The fundamentals for what can be achieved with linear control have also received industrial interest and application [Stein, 1990; Goodwin, 1997].

The outline of the paper is as follows. A nonlinear model for the quadruple-tank process based on physical data is derived in Section 2. It is linearized and some properties of the linear model is emphasized. In Section 3 linear models are estimated from experimental data and they are compared to the physical model. Simple multi-loop PI control of the quadruple-tank process is performed in Section 4 and some concluding remarks are given in Section 5.



Figure 1. The quadruple-tank laboratory process shown together with a new controller interface running on a Pentium PC.

2. Physical Model

In this section we derive a mathematical model for the quadruple-tank process from physical data.

A schematic diagram of the quadruple-tank process is shown in Figure 2. The target is to control the level in the lower two tanks with two pumps. The process inputs are v_1 and v_2 (input voltages to the pumps) and the outputs are y_1 and y_2 (voltages from level measurement devices). Mass balance for one of the tanks gives

$$A \frac{dh}{dt} = -q_{\text{out}} + q_{\text{in}},$$

where A denotes the cross-section of the tank, $h \geq 0$ the water level, and $q_{\text{in}} \geq 0$ and $q_{\text{out}} \geq 0$ the inflow and outflow of the tank, respectively. Bernoulli's law yields $q_{\text{out}} = a\sqrt{2gh}$, where a is the cross-section of the outlet hole and g is the acceleration of gravity.

The flow through each pump is split proportional to how a valve is adjusted, see Figure 2. Assume that the flow generated by the each pump is proportional to the applied voltage v and let q_L be the flow going to the

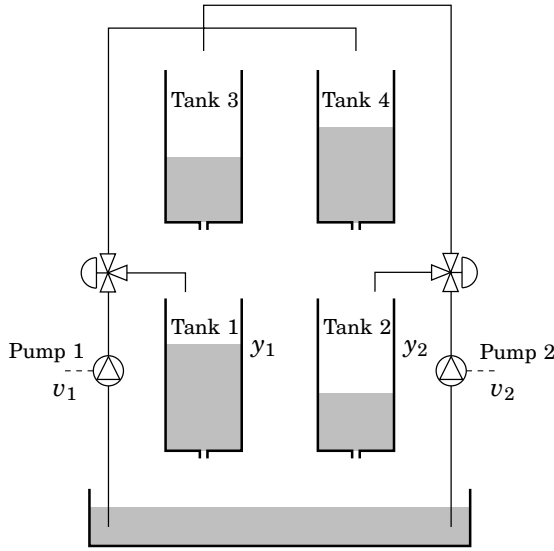

Figure 2. The quadruple-tank laboratory process. The water levels in Tank 1 and Tank 2 are controlled by two pumps. When changing the position of the valves, the location of a multivariable zero for the linearized model is moved.

lower tank and q_U the flow going to the upper tank. Then

$$q_L = \gamma kv, \quad q_U = (1 - \gamma)kv, \quad \gamma \in [0, 1].$$

The parameter γ is determined from how the valve is set. Combining these equations for the interconnected tanks gives

$$\begin{aligned} \frac{dh_1}{dt} &= -\frac{a_1}{A_1} \sqrt{2gh_1} + \frac{a_3}{A_1} \sqrt{2gh_3} + \frac{\gamma_1 k_1}{A_1} v_1, \\ \frac{dh_2}{dt} &= -\frac{a_2}{A_2} \sqrt{2gh_2} + \frac{a_4}{A_2} \sqrt{2gh_4} + \frac{\gamma_2 k_2}{A_2} v_2, \\ \frac{dh_3}{dt} &= -\frac{a_3}{A_3} \sqrt{2gh_3} + \frac{(1 - \gamma_2)k_2}{A_3} v_2, \\ \frac{dh_4}{dt} &= -\frac{a_4}{A_4} \sqrt{2gh_4} + \frac{(1 - \gamma_1)k_1}{A_4} v_1, \end{aligned} \tag{1}$$

where subscript i of a_i , A_i , and h_i represents Tank i , k_i and v_i corresponds to Pump i , and γ_i to the flow through Pump i . The measured level signals are proportional to the true levels, that is, $y_1 = k_c h_1$ and $y_2 = k_c h_2$. The parameter values of the laboratory process are given in Table 4.1. The

A_1, A_3	[cm ²]	28
A_2, A_4	[cm ²]	32
a_1, a_3	[cm ²]	0.071
a_2, a_4	[cm ²]	0.057
k_c	[V/cm]	0.50
g	[cm/s ²]	981

Table 4.1 Parameter values of the laboratory process.

pump gains k_1 and k_2 vary slightly with the operating point. Their values are given when discussing the operating points next.

Operating points

For a stationary operating point (h^0, v^0) , the differential equations in (1) give that

$$\begin{aligned} \frac{a_3}{A_3} \sqrt{2gh_3^0} &= \frac{(1-\gamma_2)k_2}{A_3} v_2^0, \\ \frac{a_4}{A_4} \sqrt{2gh_4^0} &= \frac{(1-\gamma_1)k_1}{A_4} v_1^0, \end{aligned} \quad (2)$$

and thus

$$\begin{aligned} \frac{a_1}{A_1} \sqrt{2gh_1^0} &= \frac{\gamma_1 k_1}{A_1} v_1^0 + \frac{(1-\gamma_2)k_2}{A_1} v_2^0, \\ \frac{a_2}{A_2} \sqrt{2gh_2^0} &= \frac{(1-\gamma_1)k_1}{A_2} v_1^0 + \frac{\gamma_2 k_2}{A_2} v_2^0. \end{aligned}$$

It follows that there exists a unique constant input (v_1^0, v_2^0) giving the steady-state levels (h_1^0, h_2^0) if and only if the matrix

$$M = \begin{pmatrix} \gamma_1 k_1 & (1-\gamma_2)k_2 \\ (1-\gamma_1)k_1 & \gamma_2 k_2 \end{pmatrix} \quad (3)$$

is non-singular, that is, if and only if $\gamma_1 + \gamma_2 \neq 1$. The singularity is natural. In stationarity, the flow through Tank 1 is $\gamma_1 q_1 + (1-\gamma_2)q_2$ and the flow through Tank 2 is $\gamma_2 q_2 + (1-\gamma_1)q_1$. If $\gamma_1 + \gamma_2 = 1$, these flows equal $\gamma_1(q_1 + q_2)$ and $(1-\gamma_1)(q_1 + q_2)$, respectively. The stationary flows through Tank 1 and Tank 2 are thus dependent, and so must the levels also be.

		P_-	P_+
(h_1^0, h_2^0)	[cm]	(12.4, 12.7)	(12.6, 13.0)
(h_3^0, h_4^0)	[cm]	(1.8, 1.4)	(4.8, 4.9)
(v_1^0, v_2^0)	[V]	(3.00, 3.00)	(3.15, 3.15)
(k_1, k_2)	[cm ³ /Vs]	(3.33, 3.35)	(3.14, 3.29)
(γ_1, γ_2)		(0.70, 0.60)	(0.43, 0.34)

Table 4.2 Parameter values for the minimum phase operating point P_- and the nonminimum phase point P_+ .

The model and control of the quadruple-tank process are studied at two operating points: P_- at which the system will be shown to have minimum phase characteristics and P_+ at which it will be shown to have nonminimum phase characteristics. The operating points correspond to the parameter values in Table 4.2.

Linearization

Introduce the variables $x_i := h_i - h_i^0$ and $u_i := v_i - v_i^0$. The linearized state-space equations are then given by

$$\frac{dx}{dt} = \begin{pmatrix} -\frac{1}{T_1} & 0 & \frac{A_3}{A_1 T_3} & 0 \\ 0 & -\frac{1}{T_2} & 0 & \frac{A_4}{A_2 T_4} \\ 0 & 0 & -\frac{1}{T_3} & 0 \\ 0 & 0 & 0 & -\frac{1}{T_4} \end{pmatrix} x + \begin{pmatrix} \frac{\gamma_1 k_1}{A_1} & 0 \\ 0 & \frac{\gamma_2 k_2}{A_2} \\ 0 & \frac{(1-\gamma_2)k_2}{A_3} \\ \frac{(1-\gamma_1)k_1}{A_4} & 0 \end{pmatrix} u,$$

$$y = \begin{pmatrix} k_c & 0 & 0 & 0 \\ 0 & k_c & 0 & 0 \end{pmatrix} x,$$
(4)

where the time constants are

$$T_i = \frac{A_i}{a_i} \sqrt{\frac{2h_i^0}{g}}, \quad i = 1, \dots, 4.$$

The corresponding transfer matrix is

$$G(s) = \begin{pmatrix} \frac{\gamma_1 c_1}{1 + sT_1} & \frac{(1 - \gamma_2)c_1}{(1 + sT_3)(1 + sT_1)} \\ \frac{(1 - \gamma_1)c_2}{(1 + sT_4)(1 + sT_2)} & \frac{\gamma_2 c_2}{1 + sT_2} \end{pmatrix}$$

with

$$c_1 = \frac{T_1 k_1 k_c}{A_1}, \quad c_2 = \frac{T_2 k_2 k_c}{A_2}.$$

Multivariable zeros

The multivariable zeros are in our case the zeros of the numerator polynomial of the rational function

$$\det G(s) = \frac{c_1 c_2}{\gamma_1 \gamma_2 \prod_{i=1}^4 (1 + sT_i)} \left[(1 + sT_3)(1 + sT_4) - \frac{(1 - \gamma_1)(1 - \gamma_2)}{\gamma_1 \gamma_2} \right].$$

The transfer matrix G thus has two finite zeros for $\gamma_1, \gamma_2 \in (0, 1]$. A root-locus argument gives that one of them is always in the left half-plane, but the other can be located either in the left or the right half-plane. Introduce a parameter $\eta \in [0, \infty)$ as

$$\eta := \frac{(1 - \gamma_1)(1 - \gamma_2)}{\gamma_1 \gamma_2}.$$

If η is small, the two zeros are close to $-1/T_3$ and $-1/T_4$, respectively. Furthermore, one zero tends to $-\infty$ and one zero tends to $+\infty$ as $\eta \rightarrow \infty$. If $\eta = 1$ one zero is located at the origin. This case corresponds to $\gamma_1 + \gamma_2 = 1$, which is also the condition for that the matrix M in (3) is singular. It follows that the system is nonminimum phase for

$$0 < \gamma_1 + \gamma_2 \leq 1$$

and minimum phase for

$$1 < \gamma_1 + \gamma_2 \leq 2.$$

Recall from Table 4.2 that $\gamma_1 + \gamma_2 = 1.30 > 1$ for P_- and $\gamma_1 + \gamma_2 = 0.77 < 1$ for P_+ .

For the two operating points P_- and P_+ we have the following time constants and zeros:

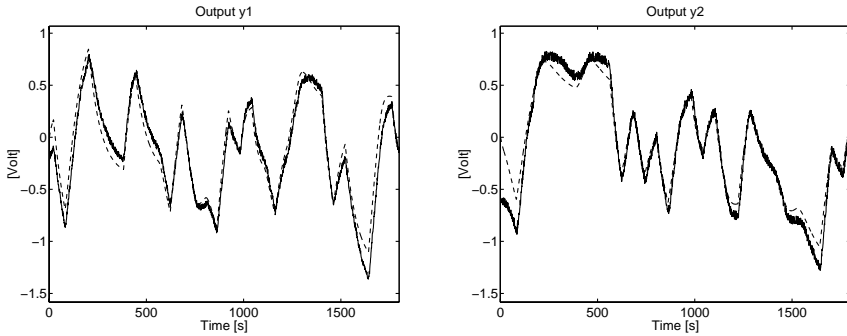

Figure 3. Validation of the linear physical model G_- . The outputs from the model (dashed lines) together with the outputs from the real process (solid lines) are shown in the minimum phase setting.

	P_-	P_+
(T_1, T_2)	(62, 90)	(63, 91)
(T_3, T_4)	(23, 30)	(39, 56)
Zeros	(-0.060, -0.018)	(-0.057, 0.013)

The dominating time constants are thus similar in both operating conditions. The physical modeling gives the two transfer matrices

$$G_- = \begin{pmatrix} \frac{2.6}{1 + 62s} & \frac{1.5}{(1 + 23s)(1 + 62s)} \\ \frac{1.4}{(1 + 30s)(1 + 90s)} & \frac{2.8}{1 + 90s} \end{pmatrix}, \quad (5)$$

$$G_+ = \begin{pmatrix} \frac{1.5}{1 + 63s} & \frac{2.5}{(1 + 39s)(1 + 63s)} \\ \frac{2.5}{(1 + 56s)(1 + 91s)} & \frac{1.6}{1 + 91s} \end{pmatrix}. \quad (6)$$

Figures 3 and 4 show simulations of these two models compared to real data obtained from identification experiments discussed in next section. The inputs are pseudo-random binary sequences (PRBSs) with low amplitudes, so that the dynamics are captured by the linear models. The model outputs agree very well with the responses of the real process.

A multivariable RHP zero may influence the achievable performance for only part of the system. The reason for this is that a multivariable zero is associated with a direction. The output direction ψ of a single zero z is a complex vector of unit length defined from

$$\psi^* G(z) = 0,$$

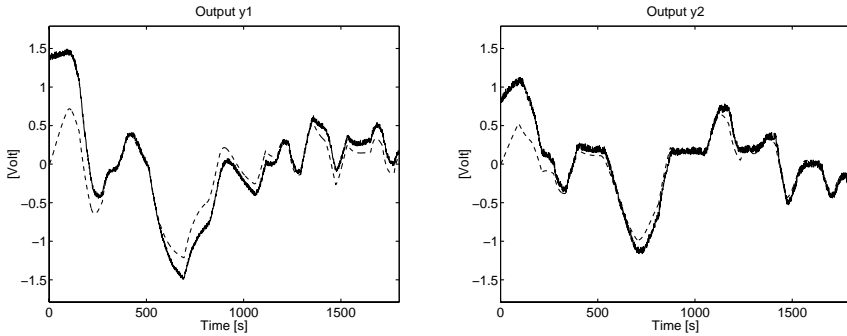

Figure 4. Validation of the linear physical model G_+ . The outputs from the model (dashed lines) together with the outputs from the real process (solid lines) are shown in the nonminimum phase setting.

where the asterisk denotes conjugate transpose. If the output direction for a RHP zero has more than one non-zero element, the effect of the zero can be distributed to the outputs associated with these elements by proper control design. Corollary 4.3.4 in [Seron *et al.*, 1997] suggests this in terms of minimizing the H_∞ norm of elements of the sensitivity function. A consequence of this result is that the deterioration resulting from a RHP zero may not be so bad for MIMO systems as for SISO. This is not the case if the output direction has only one non-zero element. A related result is given as Corollary 13.2-2 in [Morari and Zafriou, 1989] saying that if z is the only zero and element k of ψ is non-zero, then the complementary sensitivity function can be chosen such that z only shows up in diagonal element k . The influence of the zero thus cannot only be distributed, but also (if it is preferable) concentrated to one loop.

From (5) and (6) we see that neither G_- nor G_+ have a zero with unit vector direction. A multivariable control design for G_+ can thus move the effect of the RHP zero to either of the loops and the full freedom of multivariable control can be utilized. This will not be pursued further. Let it suffice to mention that the quadruple-tank process is well suited for testing multivariable design methods.

3. System Identification

The physical model derived in previous section is now compared to a model estimated using standard system identification techniques [Ljung, 1987; Johansson, 1993].

Both SIMO and MIMO identification experiments were performed with

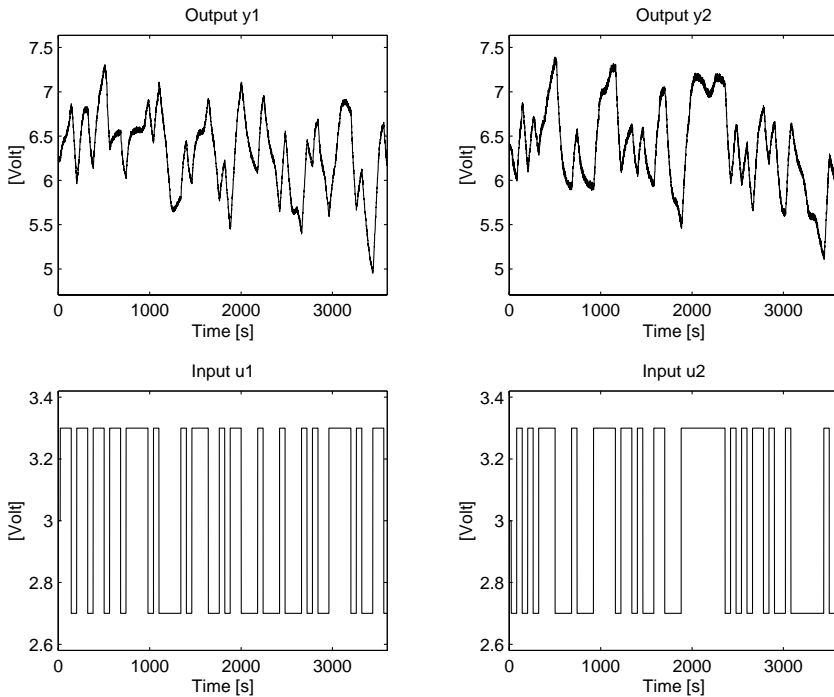

Figure 5. Identification experiment using two uncorrelated PRBS signals as inputs for the minimum phase setting.

PRBS signals as inputs. Collected data from a MIMO experiment for the minimum phase setting are shown in Figure 5. The levels of the PRBS signals were chosen so that the process dynamics were approximately linear.

Black-box and gray-box identification methods were tested using Matlab's System Identification Toolbox [Ljung, 1997]. Linear SISO, MISO, and MIMO maps were identified in ARX, ARMAX, and state-space forms. All model structures gave similar responses to validation data. Here we only present some examples of the results. We start with a black-box approach. Figure 6 shows validation data for the minimum phase setting together with a simulation of a state-space model derived with the sub-space algorithm N4SID [Van Overschee and De Moor, 1994; Ljung, 1997]. The state-space model has three real poles corresponding to time constants 8, 41, and 113. It has one multivariable zero in -0.99 . Validation data and simulation for the nonminimum phase case are given in Figure 7. This model is of fourth order and has time constants 11, 31, 140, and 220. Its

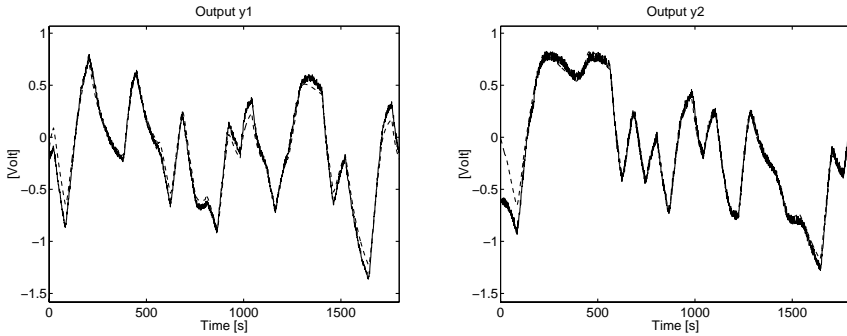

Figure 6. Validation of state-space model for the minimum phase setting. Outputs from identified model (dashed) together with the outputs from the real process (solid) are shown.

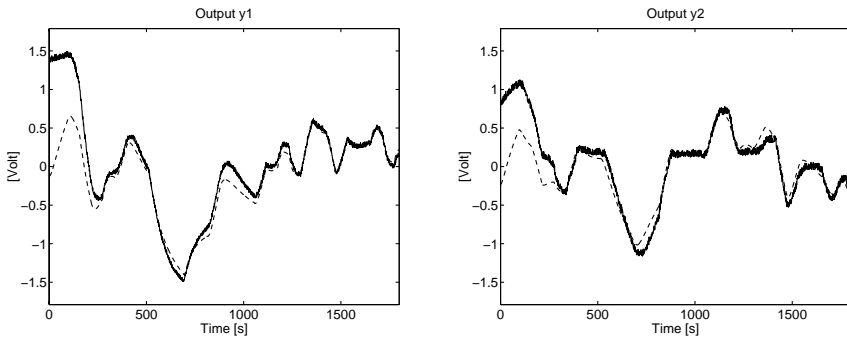

Figure 7. Validation of state-space model for the nonminimum phase setting. Outputs from identified model (dashed) together with the outputs from the real process (solid) are shown.

two zeros are located in -0.288 and 0.019 . The validation results in Figures 6 and 7 are of similar quality as the results for the physical models shown in Figures 3 and 4. Note that the minimum phase setting gives an identified model with no RHP zero, whereas the nonminimum phase setting gives a dominating RHP zero (*i.e.*, a RHP zero close to the origin compared to the time scale given by the time constants).

Gray-box models with structure fixed to the linear state-space equation (4) gave similar validation results as the previously shown. Because of the fixed structure, the number of poles and zeros are the same as for the physical model. For the minimum phase setting we have time constants $(T_1, T_2, T_3, T_4) = (96, 99, 32, 39)$ and zeros at -0.045 and -0.012 , whereas for the nonminimum phase setting we have $(T_1, T_2, T_3, T_4) =$

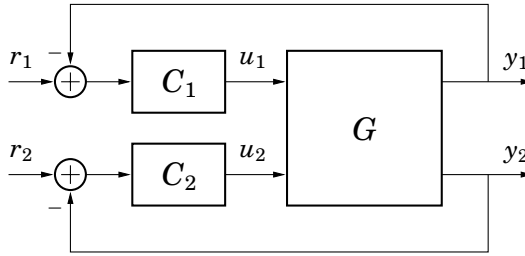

Figure 8. Multi-loop control structure with two PI controllers C_1 and C_2 .

(77, 112, 53, 55) and zeros 0.014 and -0.051 . The zeros agree very well with the ones derived from the physical model.

4. Multi-Loop Control

The multi-loop control structure shown in Figure 8 are next applied to the real process as well as to nonlinear and linear process models. PI controllers of the form

$$C_\ell(s) = K_\ell \left(1 + \frac{1}{T_{i\ell}s} \right), \quad \ell = 1, 2$$

are tuned manually based on the linear physical models (5) and (6).

For the minimum phase setting P_- the controller parameters $(K_1, T_{i1}) = (3.0, 30)$ and $(K_2, T_{i2}) = (2.7, 40)$ are easily obtained. They give reasonable performances as shown in Figure 9, where the responses are given for a step in the reference signal r_1 . The top four plots show control of the simulated nonlinear model in (1) (dashed lines) and control of the identified linear state-space model (solid). The four lower plots show the responses of the real process. The discrepancies between simulations and the true time responses are small.

It is hard to find good controller parameters for the nonminimum phase setting P_+ . The controller parameters $(K_1, T_{i1}) = (1.5, 110)$ and $(K_2, T_{i2}) = (-0.12, 220)$ stabilize the process, but give much slower responses than for the minimum phase setting, see Figure 10. Note the different time scales compared to Figure 9. The settling time is approximately ten times longer for the nonminimum phase setting. The control signal u_2 seems to be noiseless. This is due to the low gain K_2 . It is no coincidence that K_2 is chosen negative. Because $\det G_+(0) < 0$, there exists no multi-loop PI controller with $K_1 = K_2 > 0$ that stabilizes the system,

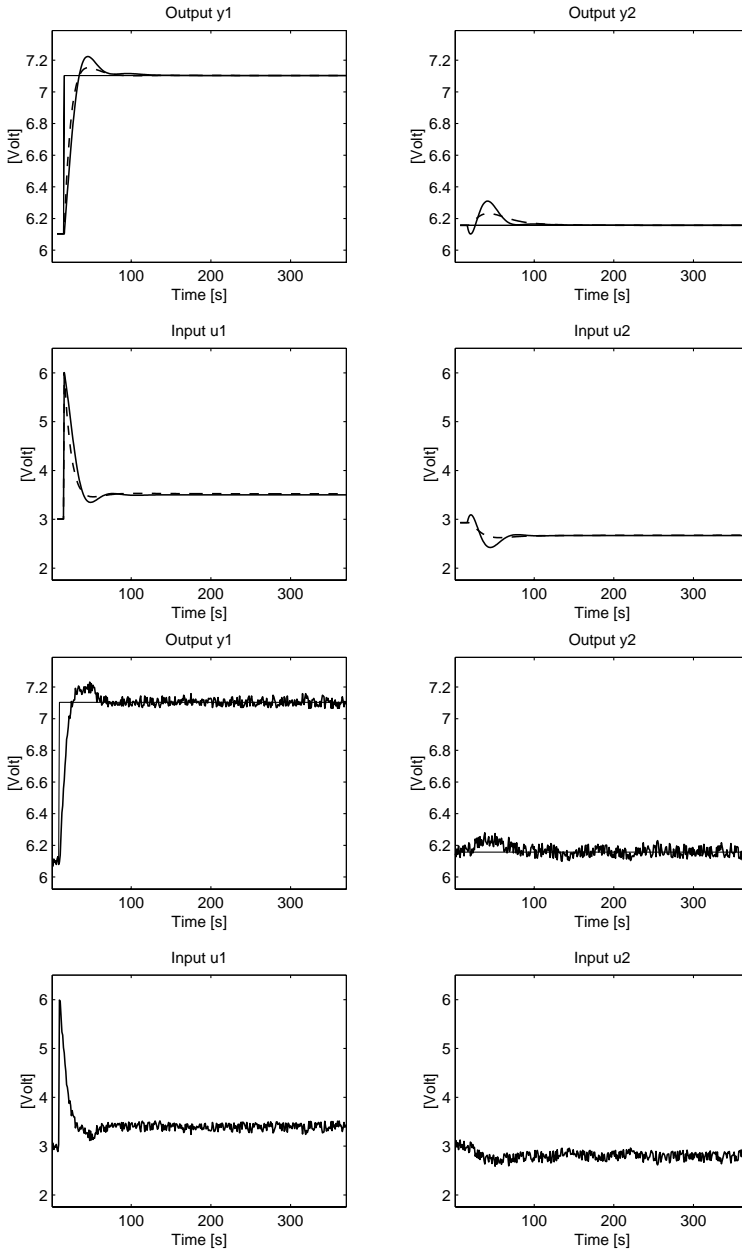

Figure 9. Results of PI control of minimum phase system. The upper four plots show simulations with the nonlinear physical model (dashed) and the identified linear model (solid). The four lower plots show experimental results.

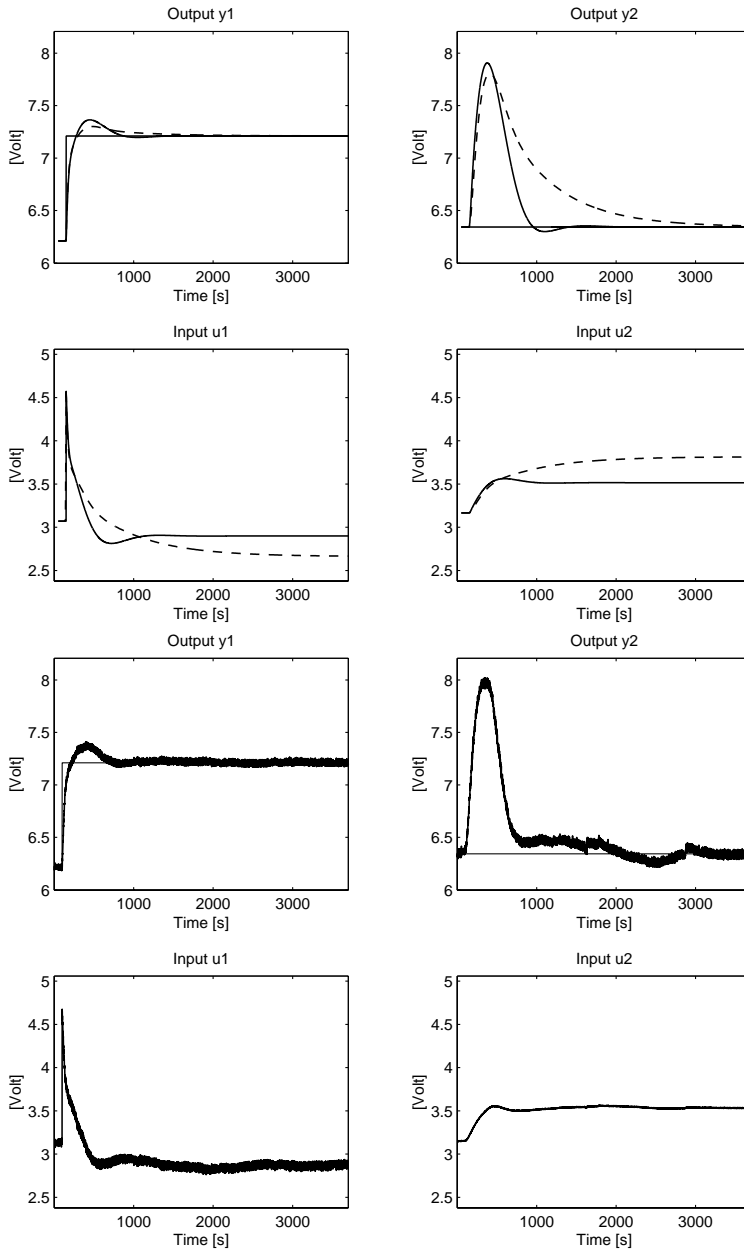

Figure 10. Results of PI control of nonminimum phase system. Same variables are shown as in Figure 9. Note the ten times longer time scale.

see Theorem 14.3-1 in [Morari and Zafiriou, 1989]. Even if the controller gains are small the closed-loop system will be unstable.

5. Conclusions

A new multivariable laboratory process has been described. The quadruple-tank process seems to fulfill the following criteria stated in [Kheir *et al.*, 1996]:

[The control laboratory's] main purpose is to provide the connection between abstract control theory and the real world. Therefore it should give an indication of how control theory can be applied and also an indication of some of its limitations.

More precisely it was shown that the quadruple-tank process is well suited for illustrating performance limitations in multivariable control design caused by RHP zeros. This followed from that the linearized model of the process has a multivariable zero that in a direct way is connected to the physical position of two valves. Models from physical data and experimental data were derived and they were shown to have responses similar to the real process. Decentralized PI control showed that it was much more difficult to control the process in the nonminimum phase case than in the minimum phase case.

The experiments described in this paper have been performed using the PC interface shown in Figure 11 [Nunes, 1997], which has been developed in the man-machine interface generator InTouch from Wonderware Corporation. The interface is connected to the real process as well as to a real-time kernel [Andersson and Blomdell, 1991], where the nonlinear model of the process can be simulated. This gives a flexible experimental platform where controllers can be designed in Matlab, loaded into the interface, simulated with the nonlinear model, and finally tested on the real process.

Ongoing work includes multivariable controller design for the quadruple-tank process. For example, a new multivariable controller tuning method based on relay feedback experiments will be tested on the process [Johansson *et al.*, 1997]. Also other control design methods will be tried.

6. References

ÅKESSON, M., E. GUSTAFSON, and K. H. JOHANSSON (1996): "Control design for a helicopter lab process." In *IFAC'96, Preprints 13th World Congress of IFAC*. San Francisco, CA.

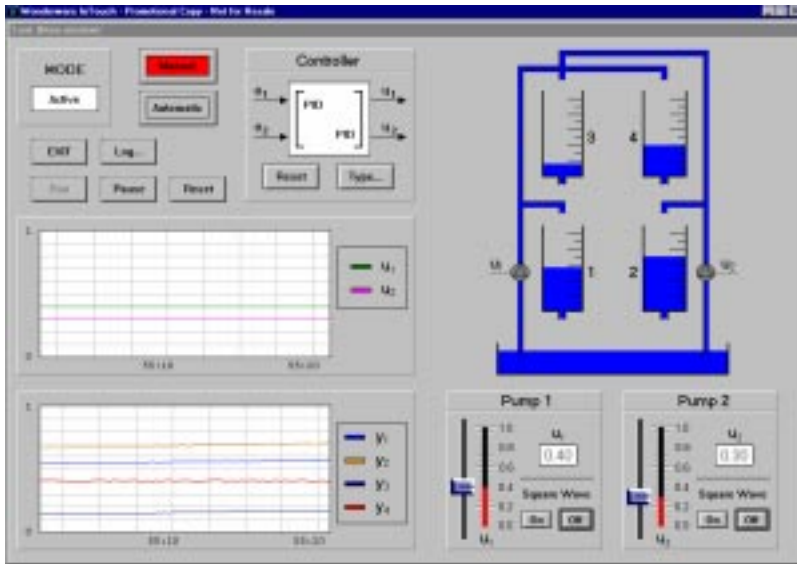

Figure 11. Computer interface developed for experiments with different control structures for the quadruple-tank process.

ANDERSSON, L. and A. BLOMDELL (1991): "A real-time programming environment and a real-time kernel." In ASPLUND, Ed., *National Swedish Symposium on Real-Time Systems*, Technical Report No 30 1991-06-21. Dept. of Computer Systems, Uppsala University, Uppsala, Sweden.

ÅSTRÖM, K. J. and M. LUNDH (1992): "Lund control program combines theory with hands-on experience." *IEEE Control Systems Magazine*, **12:3**, pp. 22–30.

ÅSTRÖM, K. J. and A.-B. ÖSTBERG (1986): "A teaching laboratory for process control." *IEEE Control Systems Magazine*, **6**, pp. 37–42.

DAVISON, E. J. (1985): "Description of multivariable apparatus for real time-control studies (MARTS)." Technical Report 8514a. Dept. of Electrical Engineering, Univ. of Toronto, Canada.

FREUDENBERG, J. and D. LOOZE (1988): *Frequency Domain Properties of Scalar and Multivariable Feedback Systems*. Springer-Verlag, Berlin, Germany.

GOODWIN, G. C. (1997): "Defining the performance envelope in industrial control." In *16th American Control Conference*. Albuquerque, NM. Plenary Session I.

- JOHANSSON, K. H., B. JAMES, G. F. BRYANT, and K. J. ÅSTRÖM (1997): "Multivariable controller tuning." Submitted to 17th American Control Conference.
- JOHANSSON, R. (1993): *System Modeling and Identification*. Prentice Hall, Englewood Cliffs, NJ.
- KHEIR, N. A., K. J. ÅSTRÖM, D. AUSLANDER, K. C. CHEOK, G. F. FRANKLIN, M. MASTEN, and M. RABINS (1996): "Control systems engineering education." *Automatica*, **32:2**, pp. 147–166.
- LJUNG, L. (1987): *System Identification—Theory for the User*. Prentice Hall, Englewood Cliffs, NJ.
- LJUNG, L. (1997): *System Identification Toolbox, Version 4.0.3*. The Mathworks, Inc.
- MANSOUR, M. and W. SCHAUFELBERGER (1989): "Software and laboratory experiment using computers in control education." *IEEE Control Systems Magazine*, **9:3**, pp. 19–24.
- MORARI, M. and E. ZAFIRIOU (1989): *Robust Process Control*. Prentice-Hall, Englewood Cliffs, NJ.
- NUNES, J. R. (1997): "Modeling and control of the quadruple-tank process." Master thesis. Department of Automatic Control, Lund Institute of Technology, Lund, Sweden.
- SERON, M. M., J. H. BRASLAVSKY, and G. C. GOODWIN (1997): *Fundamental Limitations in Filtering and Control*. Springer-Verlag.
- SHINSKEY, F. G. (1981): *Controlling Multivariable Processes*. Instrument Society of America, Research Triangle Park, NC.
- STEIN, G. (1990): "Respect the unstable." In *30th IEEE Conference on Decision and Control*. Honolulu, HI.
- VAN OVERSCHEE, P. and B. DE MOOR (1994): "N4SID: Subspace algorithms for the identification of combined deterministic-stochastic systems." *Automatica*, **30:1**, pp. 75–93.
- VISCHER, D. and H. BLEULER (1990): "A new approach to sensorless and voltage controlled AMBs based on network theory concepts." In *2nd International Symposium on Magnetic Bearings*. Institute of Industrial Science, Tokyo University.

Paper 5

Multivariable Controller Tuning

**Karl Henrik Johansson, Ben James,
Greyham F. Bryant, and Karl Johan Åström**

Abstract

The problem of tuning individual loops in a multivariable controller is investigated. It is shown how the performance of a specific loop relates to a row in the controller matrix. Several interpretations of this relation are given. An algorithm is also presented that estimates the model required for the tuning via a relay feedback experiment. The algorithm does not need any prior information about the system or the controller. The results are illustrated by examples.

1. Introduction

Poorly tuned control loops represent a large economic cost for industry [Ender, 1993]. It has been claimed that only twenty percent of the loops in pulp and paper industry reduce variability [Bialkowski, 1992]. Control parameters are often set to default values or are manually tuned in an *ad hoc* way. The reason for this is that there is a great lack of tools for tuning industrial controllers systematically. Nowadays there exist methods for automatic tuning of SISO control loops, which have been widely accepted and implemented in several commercial controllers [Åström and Hägglund, 1995]. Many control loops are, however, coupled and the interaction has to be considered in the control design to gain improved performance [Shinsky, 1981]. Most modern multivariable control design methods require a full model of the process [Maciejowski, 1989]. In many cases such a model is not available and physical modeling or system identification may require a prohibitive engineering effort. Furthermore, it is hard, or impossible, to impose a certain control structure on standard multivariable design methods. Therefore, there is a need for simple methods of tuning multivariable controllers; particularly methods that compromise optimality for engineering efficiency.

This paper focus on the problem of retuning an existing multivariable control system. A framework is developed where it is possible to derive the influence of retuning one loop on the overall closed-loop performance. A badly tuned loop can in this way be improved by changing certain elements of the controller matrix. Tuning a loop corresponds to changing a row in the controller matrix; hence, to solve a SIMO control design problem. The idea is that this description can be exploited in conjunction with the designer's knowledge of the process to achieve the desired closed-loop performance and robustness specifications. Several quantities useful for estimating the influence of a controller row on the closed-loop system are derived in the paper. The information required for this type of design is also discussed together with how this information can be obtained. It is shown that no prior knowledge of the process dynamics or of the controller dynamics is needed, if a modeling experiment based on relay feedback is used.

In existing work on extending the auto-tuning method for SISO control systems developed in [Åström and Hägglund, 1984] to MIMO systems, either one relay is used for each experiment by closing one loop at a time [Hang *et al.*, 1994; Friman and Waller, 1994; Vasnani, 1994; Shen and Yu, 1994] or all loops are set under relay feedback simultaneously [Zhuang and Atherton, 1994; Vasnani, 1994; Palmor *et al.*, 1995; Wang *et al.*, 1997]. A major drawback with the latter approach is that instead of giving stationary limit cycles the relays can induce very complicated oscillations

[Vasnani, 1994; Johansson, 1997]. There exist no results in terms of plant data for when this may or may not happen. Based on a successful relay experiment a controller is designed. Most authors limit the control structure to a decentralized configuration of SISO PID controllers [Zgorzelski *et al.*, 1990; Vasnani, 1994; Zhuang and Atherton, 1994; Shen and Yu, 1994; Palmor *et al.*, 1995]. Decoupling design is derived in [Friman and Waller, 1994; Wang *et al.*, 1997]. Tuning cascade controllers (MISO controllers) is considered in [Hang *et al.*, 1994]. For a survey on relay feedback methods see [Åström *et al.*, 1995].

In the present paper we use relay feedback experiments for tuning a general multivariable controller. We choose a type of single-relay experiment due to its robustness. The approach allows freedom in the choice of control structure and multivariable design method. This means that a decentralized PID controller can be used if the system is easy to control, whereas a MIMO controller might be better in other situations. The proposed method covers some of the preceding proposals from the literature, and can be seen as a formalization or generalization of some of them. For example, conditions for closed-loop stability using the suggested method are derived.

The philosophy of treating a multivariable design problem as a series of single-loop designs underlies various well-established design methodologies, such as sequential loop-closure and dominance design. It is also the way most multivariable control designs are done in practice [Mayne, 1979; Bryant and Yeung, 1996]. The sequential methods have the advantage of being able to deal with control structure constraints. Tuning methods for SISO controllers in MIMO systems are discussed in [Luyben, 1986; Gawthrop and Nomikos, 1990; Desbiens *et al.*, 1996] and in many textbooks in process control such as [Seborg *et al.*, 1989; Morari and Zafiriou, 1989]. One common approach is to detune controller parameters derived using SISO design techniques [Niederlinski, 1971; Toh and Devanathan, 1993]. This may, however, give a too low bandwidth. See [Maciejowski, 1989] for a survey on control design methods.

The outline of the paper is as follows. Section 2 presents some results that are useful for loop tuning. Retuning a row in the controller matrix is formalized. In Section 3 it is shown that the required information about the system can be obtained from an experiment with relay feedback. Section 4 describes an application to a model of a new laboratory process. Some concluding remarks are given in Section 5.

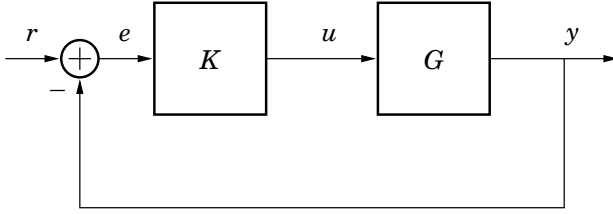

Figure 1. Multivariable feedback system.

2. Loop Tuning

Suppose that a multivariable control system with unsatisfactory closed-loop performance is given, for example, a loop may have too low a bandwidth yielding slow responses. The basic idea is to adjust certain elements of the controller matrix in order to improve the closed-loop behavior. In general, such an adjustment will affect all loops in the system. The challenge is to obtain this effect on the desired loop without degrading the performance of the other loops. This section gives results which enables the designer to compute the effect of an adjustment of a single loop on the overall closed-loop behavior.

Notation

Assume that there exists a stable closed-loop system as in Figure 1, comprising a process G and a nominal controller K , both with m inputs and m outputs. Denote the manipulated variable or process input $u = (u_1, \dots, u_m)^T$, the controlled variable or process output $y = (y_1, \dots, y_m)^T$, and the reference or set-point $r = (r_1, \dots, r_m)^T$. The controller matrix K acts on the error signal $e = (e_1, \dots, e_m)^T = r - y$. Hence, $y = Gu$ and $u = Ke$. The aim of the tuning procedure is to improve the performance of one loop by adjusting appropriate elements of the controller matrix. Without loss of generality, consider loop m and define the following partitions:

$$G = \begin{matrix} & \begin{matrix} m-1 & 1 \end{matrix} \\ \begin{matrix} m \\ \end{matrix} & \begin{pmatrix} G_1 & G_2 \end{pmatrix} \end{matrix}, \quad K = \begin{matrix} & \begin{matrix} m-1 & 1 \end{matrix} \\ \begin{matrix} m \\ \end{matrix} & \begin{pmatrix} K_1 \\ k \end{pmatrix} \end{matrix}. \quad (1)$$

Partition the signal vectors $u = (\bar{u}^T, u_m)^T$, $y = (\bar{y}^T, y_m)^T$, $r = (\bar{r}^T, r_m)^T$, and $e = (\bar{e}^T, e_m)^T$ correspondingly, so that $\bar{u} = (u_1, \dots, u_{m-1})^T$ etc. Then

$$u_m = \varepsilon_m^T K e = k e = k_1 e_1 + \dots + k_m e_m,$$

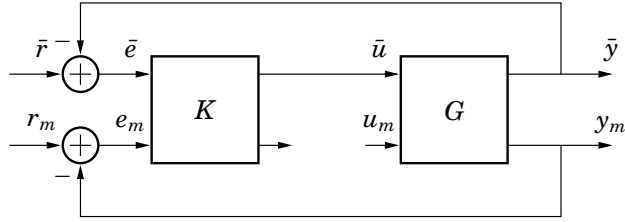

Figure 2. Opening of control loop m for controller row retuning.

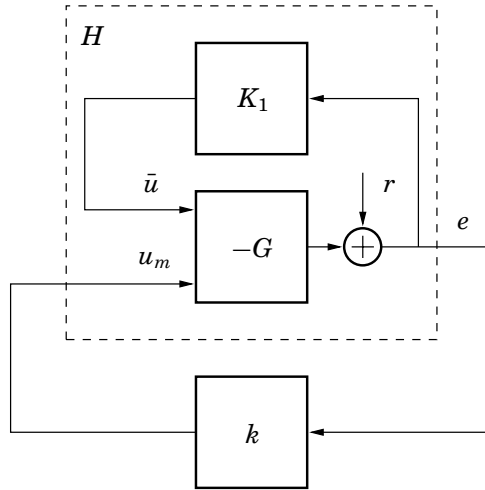

Figure 3. Contribution of controller row k . The dashed box corresponds to H .

where $\varepsilon_m^T = (0, \dots, 0, 1)$ and k_i , $i = 1, \dots, m$, are the elements of k . Row m of the controller matrix K thus contains the coupling from the error e to the control signal u_m . Figure 2 shows the closed-loop system with the signal path u_m broken. Any sensible choice of the controller row k that improves the performance of loop m , requires at least knowledge of the SIMO transfer matrix from u_m to e in this partially open system. We denote this transfer matrix

$$H = -(I + G_1 K_1)^{-1} G_2,$$

and assume that it is stable. The block diagram of Figure 3 shows explicitly the contribution of controller row m to the feedback control of the system. The transfer matrices of the full multivariable closed-loop system

can easily be described in terms of those for the system with H acting as a process and k as a controller. In other words, the multivariable control design problem for G is reduced to a SIMO control problem for H with MISO controller k .

Parameterization

It is simple to calculate the effect of new or redesigned controller row elements of the single-loop opening approach. If loop m is opened, the input sensitivity function $S_i := (I + KG)^{-1}$ and the output sensitivity function $S_o := (I + GK)^{-1}$ are replaced by

$$\begin{aligned}\tilde{S}_i &:= \left(I + \begin{pmatrix} K_1 \\ 0 \end{pmatrix} G \right)^{-1} = \begin{pmatrix} (I + K_1 G_1)^{-1} & -(I + K_1 G_1)^{-1} K_1 G_2 \\ 0 & 1 \end{pmatrix}, \\ \tilde{S}_o &:= \left(I + G \begin{pmatrix} K_1 \\ 0 \end{pmatrix} \right)^{-1} = (I + G_1 K_1)^{-1},\end{aligned}$$

respectively. We can also express S_i in terms of \tilde{S}_i :

$$S_i = \tilde{S}_i (I + \varepsilon_m k G \tilde{S}_i)^{-1}.$$

If \tilde{S}_i is partitioned similar to $G = (G_1, G_2)$, so that

$$\tilde{S}_i = \begin{matrix} m-1 & 1 \\ \tilde{S}_{i1} & \tilde{S}_{i2} \end{matrix},$$

then

$$H = -\tilde{S}_o G_2 = -G \tilde{S}_{i2}.$$

The diagonal element m of the sensitivity matrix S_i captures much of the performance in loop m . By the definition of H and k , we have that

$$\varepsilon_m^T S_i \varepsilon_m = \frac{1}{1 - kH}.$$

Knowledge of H alone is thus sufficient to compute the transfer function for loop m that results from a particular choice of k .

The closed-loop transfer matrices are affine functions in the Youla parameter $Q := (I + KG)^{-1}K$ if G is stable [Maciejowski, 1989]. For example, the sensitivity and complementary sensitivity matrices with reference to process inputs are $S_i = I - QG$ and $T_i = QG$, respectively, and the corresponding matrices with reference to process outputs are $S_o = I - GQ$ and $T_o = GQ$. The closed-loop transfer matrices are also affine functions in

$$q := \frac{k}{1 - kH}.$$

This $1 \times m$ vector of transfer functions is the Youla parameter for the partially open system. Some calculations gives the relation between q and Q as

$$Q = \begin{pmatrix} K_1 \\ 0 \end{pmatrix} (I + G_1 K_1)^{-1} + \begin{pmatrix} K_1 H \\ 1 \end{pmatrix} q (I + G_1 K_1)^{-1}.$$

Parameterization of stabilizing controller rows and columns are studied in [James and Bryant, 1995].

Nyquist theorem

Naturally, any adjustment of controller row m must be made in such a way that the closed loop system remains stable. The following proposition states a Nyquist stability result concerning this. First, let D_N denote the usual Nyquist contour encircling the right half-plane (RHP) and $N(f(s), z)$ the number of clockwise encirclements of the point z by the image of the contour D_N under the map f as it is traversed in a clockwise direction.

PROPOSITION 1

Assume the closed-loop system is stable with controller row k . Let k be replaced by \hat{k} , where \hat{k} is such that no unstable modes are cancelled and that the number of open-loop RHP poles does not change. Then the adjusted closed-loop system remains stable if and only if

$$N(1 - \hat{k}H, 0) = N(1 - kH, 0).$$

Proof: Because

$$\det(I + KG) = (1 - kH) \det\left(I + \begin{pmatrix} K_1 \\ 0 \end{pmatrix} G\right) = (1 - kH) \det(I + K_1 G_1),$$

application of the generalized Nyquist stability theorem [Maciejowski, 1989] with respect to the return difference $I + KG$ establishes the result. \square

By introducing new controller row entries it is possible to obtain a MIMO control system with more freedom than the corresponding decentralized control system. The following result follows from application of classical pole placement [Shaked and MacFarlane, 1977; Bryant, 1985].

PROPOSITION 2

If g_1 and g_2 are two scalar transfer functions with no common RHP poles or zeros, then there exist two scalar transfer functions k_1 and k_2 such that $g_1k_1 + g_2k_2$ has no RHP zeros. \square

Although the result illustrates an advantage of using MIMO control instead of SISO control, the limitations due to RHP zeros cannot be circumvented by a multivariable controller. Restrictions on performance imposed by multivariable zeros are derived in [Zames, 1981]. It is shown that independent of the controller structure, there are bounds on the achievable sensitivity function. However, in [Seron *et al.*, 1997] it is shown that these bounds are less severe if a centralized multivariable controller structure is used. The effect of a multivariable zero can be assigned to certain control loops by such a controller. The effect of a zero can also be distributed among several loops.

Example

The row tuning procedure is illustrated on the Rosenbrock system

$$G = \begin{pmatrix} \frac{1-s}{(s+1)^2} & \frac{2-s}{(s+1)^2} \\ \frac{1-3s}{3(s+1)^2} & \frac{1-s}{(s+1)^2} \end{pmatrix}.$$

This system is known to have severe interactions, which makes it difficult to control by two SISO controllers. Let the system initially be controlled by

$$K = \begin{pmatrix} \frac{8s+10}{20s} & 0 \\ 0 & \frac{6s+10}{10s} \end{pmatrix}.$$

This multi-loop PI controller gives quite poor control with oscillatory set-point responses. Assume that the second loop is to be retuned. Straight-forward calculations give

$$H = \begin{pmatrix} \frac{5s^2 - 10s}{5s^3 + 8s^2 + 6s + 1} \\ \frac{15s^4 + 15s^3 - 17s^2 - 18s - 1}{15s^5 + 54s^4 + 81s^3 + 63s^2 + 24s + 3} \end{pmatrix}.$$

The transfer function H_2 has a RHP zero in 1.09, which hence impose restriction on the performance achievable with a SISO controller in the

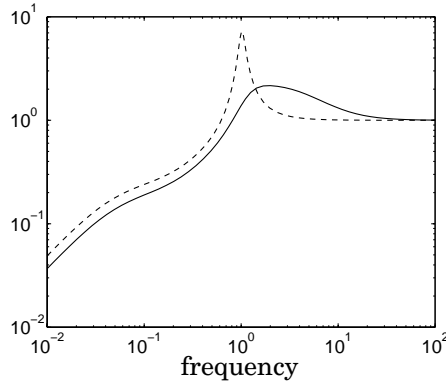

Figure 4. Second diagonal element of S_i for original (dashed line) and retuned (solid line) system.

second loop. To improve the response of the second loop a PD element is introduced; the second controller row is replaced by

$$k = \left(\frac{4s + 2}{s + 10} \quad \frac{6s + 10}{10s} \right).$$

Figure 4 shows the second diagonal element of the input sensitivity function for the initial control system and the improved system. Step responses are shown in Figure 5. A unit step in r_1 is applied at $t = 1$ and a unit step in r_2 at $t = 50$. As predicted, the response of y_2 is improved considerably. A retuned second loop may, of course, deteriorate the response in the first loop. Figure 5 shows that this is not the case in this particular example. If there would have been a performance loss in the first loop, it could have been retuned in a similar way as the second. This sequential way of tuning controllers is often used in practice.

Why controller rows and not columns?

A system parameterization in controller rows were given in this section. A dual representation for controller columns exist. The elements of control column m describe the coupling between controller input e_m and controller output u . Column control design is then governed by the partially open system from u to e_m , with the feedback path from y_m open. It turns out, as we will see in next section, that the row formulation is best suited for experiments with relay feedback. It is thus the choice in this paper.

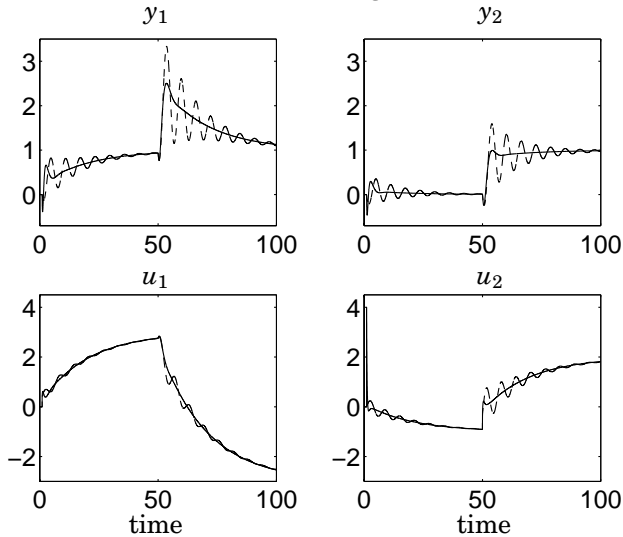

Figure 5. Step responses for original (dashed) and retuned (solid) system.

3. Relay Experiment

A relay feedback experiment is a simple and robust way of doing closed-loop identification. The setup for the original SISO experiment is simply to replace the SISO controller by a relay [Åström and Hägglund, 1984]. For a large class of systems the relay induces a stationary oscillation. The frequency of this oscillation and its amplitude can be used for tuning SISO PID controllers similar to Ziegler and Nichols' method [Ziegler and Nichols, 1942]. After the PID parameters are derived, the relay is replaced by the tuned controller.

The main advantages of an identification experiment based on relay feedback are (1) that the frequency of the excitation signal is near the cross-over frequency of the open-loop system, (2) that the experiment is done in closed loop, and (3) that no prior knowledge about the process dynamics is needed. The frequency of the relay output is close to optimum in the sense that it is in the band where the estimated model has to be accurate to support a satisfying control design. Even if no controller is present in the loop during the experiment, the relay itself gives a high-gain feedback. This means, for instance, that the process is automatically kept close to its operating point during the experiment.

A drawback with the original relay feedback experiment is its lack of excitation. Because only a square-wave of a single frequency enters the

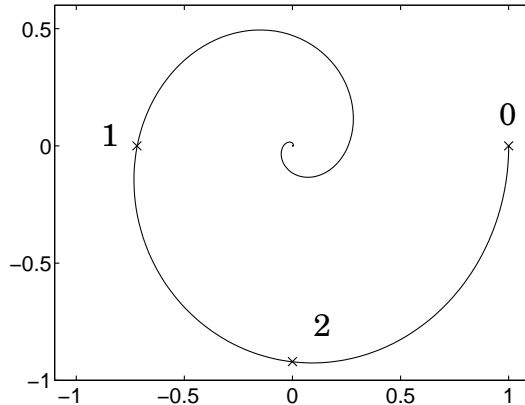

Figure 6. Three important points on the Nyquist curve.

process, only models such as

$$G(s) = \frac{K}{1 + sT} e^{-sL}$$

can be estimated. (The steady-state gain K is easily estimated from a step-response experiment or by adding a bias to the relay output [Wang *et al.*, 1997].) If more complex models are needed, we must have a wider frequency band of excitation. Next we introduce a modification of the standard relay experiment, by simply estimating two points on the Nyquist curve instead of one.

Extended relay experiment

It is well-known that with a filter in series with the relay, any point on the Nyquist curve can be estimated using relay feedback [Åström and Hägglund, 1995]. This idea has been explored for SISO systems in [Schei, 1992; Schei, 1994]. Persson [Persson, 1992] investigated the amount of process information needed for control design in number of points and their location on the Nyquist curve. Three crucial points are marked with crosses in Figure 6. Point 1 is determined by a standard relay experiment, whereas Point 2 is determined from an experiment with a relay and an integrator in series. Figure 7 shows an extended relay experiment applied to a SISO system. The filter W is initially set to $W = 1$ and then to $W = 1/s$. Together with steady-state data, this information is sufficient to derive a model of the form

$$G(s) = \frac{b_0s + b_1}{s^3 + a_1s^2 + a_2s + a_3}. \quad (2)$$

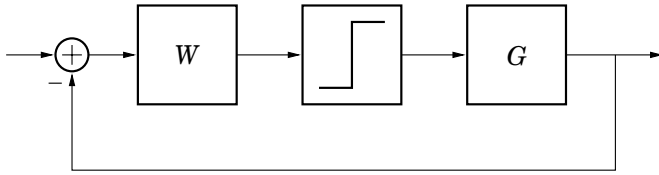

Figure 7. Extended relay feedback experiment for SISO system.

The controller tuning described in Section 2 is based on knowledge of the column vector H . The set-up for an extended relay experiment to identify H is shown in Figure 8, compare with Figures 3 and 7. The block with ε_m^T picks out error signal e_m . The relay is thus connected between We_m and u_m . This gives an oscillation with frequencies determined by H_m , which is typically the most important transfer function for controller tuning in loop m . From measuring \bar{e} and e_m , we can estimate all elements of H . We summarize the method in the following algorithm.

ALGORITHM 1—SIMO RELAY EXPERIMENT

1. Set $W = 1$ and wait for a stationary oscillation. Measure the frequency ω_1 and derive the response for each element H_i .
2. Set $W = 1/s$ and wait for a stationary oscillation. Measure the frequency ω_2 and derive the response for each element H_i .
3. Freeze the relay output and wait for steady-state and derive the steady-state gains for each element H_i .
4. Estimate H_i as in (2) based on the responses and the corresponding frequencies ω_1 and ω_2 .

□

The amounts of time required for a stationary oscillation in Step 1 and Step 2 are small. Experiments show that stationarity is often reached after three–four relay switches.

Because of measurement noise, the relay must have hysteresis in all practical implementations. The estimated points on the Nyquist curve will then differ slightly from Point 1 and Point 2 in Figure 6. This can be easily compensated, see [Åström and Häggglund, 1995].

Note that Algorithm 1 automatically gives highest priority to the last element of H in the sense that the excitation frequencies are adjusted to suit H_m . This means also that if H_1, \dots, H_{m-1} give small responses around the cross-over frequency of H_m , then the estimates of H_1, \dots, H_{m-1} are

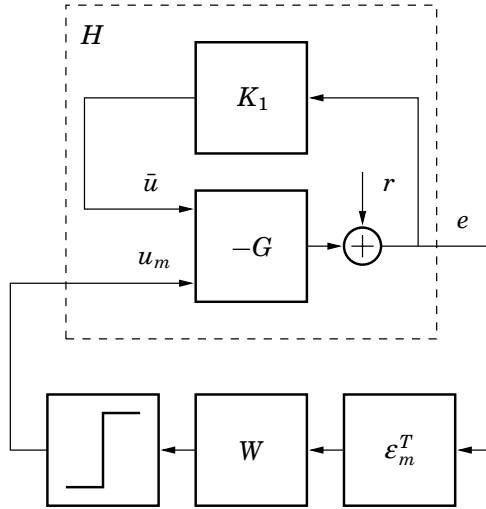

Figure 8. Relay experiment for identifying H .

probably poor. However, because the elements are small, the lack of accuracy has only a small influence on the control performance. This simple measure of the size of H_i in three frequency points indicates if multi-loop SISO control is sufficient or not. This is illustrated by the examples in next section.

If more than one loop is initially poorly tuned or if a second loop is affected by the tuning procedure of loop m , it might be necessary to repeat the tuning for the other loops. After m relay experiments, a model of the system G can be derived from the obtained data. The procedure is illustrated for a system with $m = 2$ loops. Let $H^1 = H$ with H defined as above and let H^2 equal the corresponding column when the second loop is closed instead of the first. Then we have $G = (G_1, G_2)$ with

$$G_1 = \frac{(I - H^1 k^2) H^2}{k^1 H^1 k^2 H^2 - 1}, \quad G_2 = \frac{(I - H^2 k^1) H^1}{k^1 H^1 k^2 H^2 - 1},$$

where k^1 and k^2 are controller row one and two, respectively. A variety of multivariable control design methods can be applied to the estimated G . Note that the same information can be obtained from two closed-loop relay experiments, where the relay is first connected between r_1 and y_1 and then between r_2 and y_2 . No signal paths in the existing control system have to be opened. This approach may be chosen if no loop openings of the existing control system are tolerated.

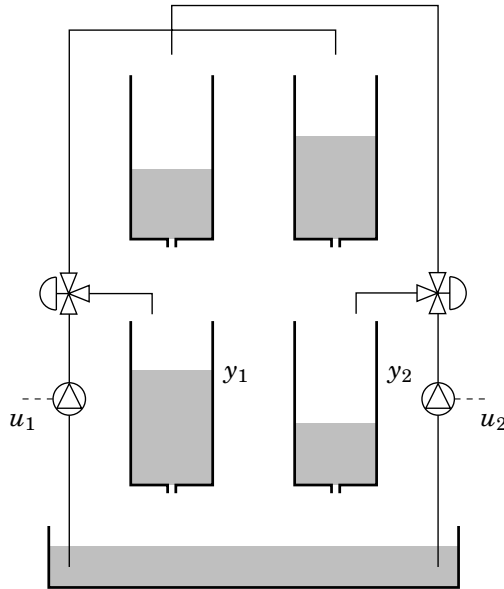

Figure 9. The quadruple-tank laboratory process. The water levels in the lower two tanks are controlled with the help of two pumps.

4. Example

In this section the retuning procedure is applied to a multivariable level control problem. The considered system is the quadruple-tank laboratory process consisting of four water tanks shown in Figure 9. Modeling and control of the real process is described in [Johansson and Nunes, 1997]. Here we use a normalized model. The two valves are set prior to an experiment. In this way it is possible to make the control problem easy or difficult. The positions of the valves can be interpreted in terms of two parameters $\gamma_1, \gamma_2 \in [0, 1]$. With $\gamma_i = 0$ the flow goes only to the upper tank and with $\gamma_i = 1$ the flow goes only to the lower tank. The linearized system that maps pump flows to tank levels has the transfer matrix

$$P = \begin{pmatrix} \frac{\gamma_1 c_{11}}{1 + sT_1} & \frac{(1 - \gamma_2) c_{12}}{(1 + sT_1)(1 + sT_3)} \\ \frac{(1 - \gamma_1) c_{21}}{(1 + sT_2)(1 + sT_4)} & \frac{\gamma_2 c_{22}}{1 + sT_2} \end{pmatrix},$$

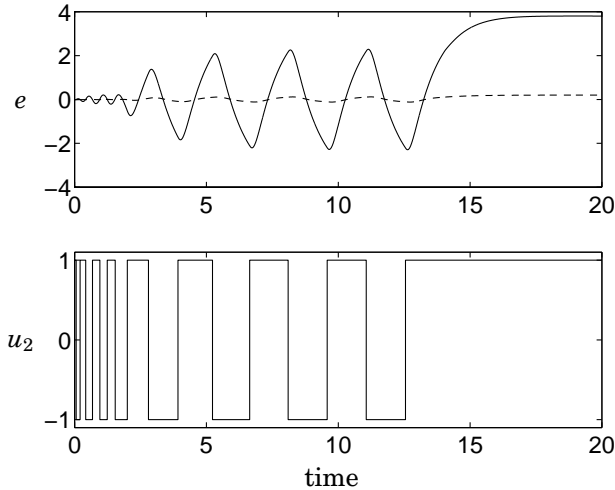

Figure 10. Extended relay experiment for minimum phase system. The error signal e_1 (dashed) is negligible compared to e_2 (solid).

where T_i and c_{ij} depend on the cross-section areas of the tanks, the cross-section areas of the outlets, and the operating point. Here we study a normalized model with $c_{ij} = 5$ and $T_i = 1$. We model the dynamics in the actuators and measurement devices as first-order lags $10/(s+10)$, so that the open-loop system is given by

$$G = \frac{500}{(s+10)^2} \begin{pmatrix} \frac{\gamma_1}{s+1} & \frac{1-\gamma_2}{(s+1)^2} \\ \frac{1-\gamma_1}{(s+1)^2} & \frac{\gamma_2}{s+1} \end{pmatrix}.$$

It can be shown that G has a RHP zero if and only if $\gamma_1 + \gamma_2 \in (0, 1]$, see [Johansson and Nunes, 1997]. Next we study the system for one setting without a RHP zero and one with a RHP zero.

Minimum phase system

Let $\gamma_1 = \gamma_2 = 4/5$. Then G has zeros in $-5/4$ and $-3/4$, so the system is minimum phase. Let $K = \text{diag}\{1, 1\}$ be the initial controller. The response of the extended relay experiment described in Algorithm 1 is shown in Figure 10. The response of e_1 is small compared to e_2 . This is further illustrated in Figure 11, where the small crosses are the estimated frequency points for H_1 and the large crosses the points for H_2 . The dashed curves are the Nyquist curves for the true systems, whereas the solid curve is a third-order estimate of H_2 .

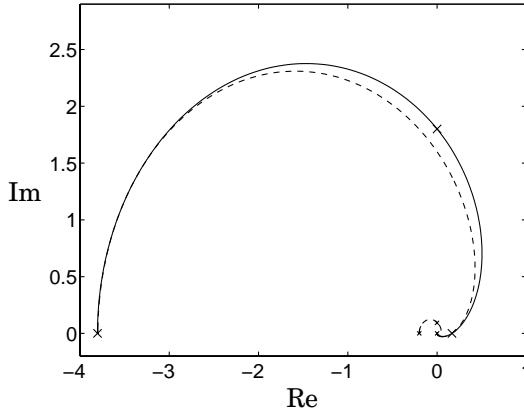

Figure 11. Nyquist curves of H for minimum phase system. The crosses are estimated frequency points from relay feedback experiments. The small crosses correspond to H_1 and the large to H_2 . A third-order estimate of H_2 is also shown (solid line). The frequency response of H_1 is negligible compared to the response of H_2 .

The result from the relay experiment indicates that we can neglect the influence of H_1 and simply retune the last element of k . The PI controller

$$k = \left(0 \quad \frac{2s + 3}{s} \right)$$

gives the poles -41.9 and $-2.2 \pm 4.6i$ for the second diagonal element of S_i . Note that the tuning here corresponds to applying SISO methods. For this example the MIMO characteristics of the system are insignificant.

Nonminimum phase system

Let us now change the valves so that $\gamma_1 = \gamma_2 = 2/5$. Then G has zeros in $-5/2$ and $1/2$, so the system is nonminimum phase. Let $K = \text{diag}\{-0.1, 0.1\}$ be the initial controller. Figure 12 shows the result of the relay experiment. The estimated Nyquist curves (solid) are shown in Figure 13, together with the true ones (dashed). We see that the interaction is severe, so it is probably not sufficient to only retune the second loop. If a relay experiment is also done in the first loop, it is straightforward to derive a multivariable controller, for example based on decoupling.

5. Conclusions

It was shown how a poorly tuned multivariable controller can be retuned through a simple closed-loop experiment based on relay feedback and controller row design. In particular, the case with one bad loop was discussed.

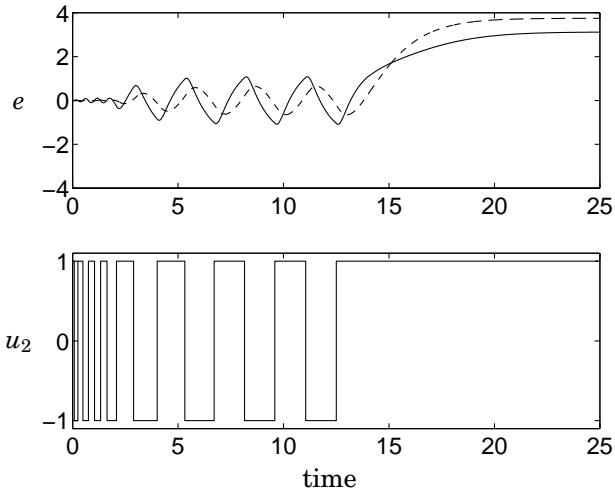

Figure 12. Extended relay experiment for nonminimum phase system. The error signals e_1 (dashed) and e_2 (solid) are of the same magnitude.

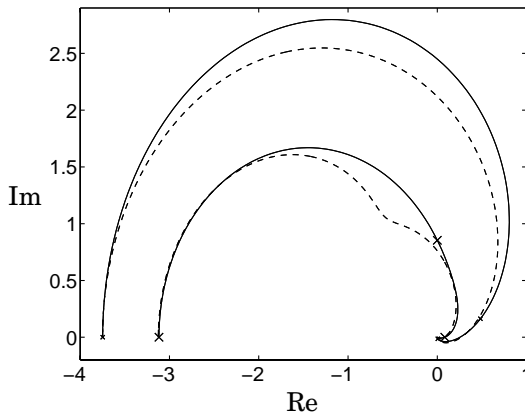

Figure 13. Nyquist curves of H for nonminimum phase system. The crosses are estimated frequency points from relay feedback experiments. The small crosses correspond to H_1 and the large to H_2 . Third-order estimates of H_1 and H_2 are also shown (solid lines). The frequency responses of H_1 and H_2 are of the same magnitude.

The standard SISO relay feedback experiment in [Åström and Hägglund, 1995] was extended to give better excitation and a more accurate model, which seems to be necessary for many MIMO control designs. Several results on how a row in the controller matrix affects the closed-loop per-

formance were derived. No fully automatic procedure was described in the sense of automatic tuning for SISO systems. It is believed that this can only be done if the considered class of systems is more limited than in this paper. It was pointed out through an example that for “simple” multivariable control systems the proposed method agrees with automatic SISO tuning. For “difficult” MIMO control problems the method still provides a solid ground for controller design.

6. References

- ÅSTRÖM, K. J. and T. HÄGGLUND (1984): “Automatic tuning of simple regulators with specifications on phase and amplitude margins.” *Automatica*, **20**, pp. 645–651.
- ÅSTRÖM, K. J. and T. HÄGGLUND (1995): *PID Controllers: Theory, Design, and Tuning*, second edition. Instrument Society of America, Research Triangle Park, NC.
- ÅSTRÖM, K. J., T. H. LEE, K. K. TAN, and K. H. JOHANSSON (1995): “Recent advances in relay feedback methods—a survey.” In *IEEE SMC Conference*, pp. 2616–2621. Vancouver, WA. Invited paper.
- BIALKOWSKI, W. L. (1992): “Dreams vs reality: A view from both sides of the gap.” In *Control Systems '92*. Whistler, B.C., Canada.
- BRYANT, G. F. (1985): “Direct methods in multivariable control I—Gauss elimination revisited.” In *IEE Control*, vol. 1, pp. 83–88.
- BRYANT, G. F. and L. F. YEUNG (1996): *Multivariable Control System Design Techniques: Dominance and Direct Methods*. Wiley.
- DESBIENS, A., A. POMERLEAU, and D. HODOUIN (1996): “Frequency based tuning of SISO controllers for two-by-two processes.” *IEE Proc. Control Theory Appl.*, **143:1**, pp. 49–56.
- ENDER, D. B. (1993): “Process control performance: Not as good as you think.” *Control Engineering*, **40:10**, pp. 180–190.
- FRIMAN, M. and K. V. WALLER (1994): “Autotuning of multiloop control systems.” *Ind. Eng. Chem. Res.*, **33**, pp. 1708–1717.
- GAWTHROP, P. J. and P. E. NOMIKOS (1990): “Automatic tuning of commercial PID controllers for single-loop and multiloop applications.” *IEEE Control Systems Magazine*, January, pp. 34–42.
- HANG, C. C., A. P. LOH, and V. U. VASNANI (1994): “Relay feedback auto-tuning of cascade controllers.” *IEEE Trans. on Control Systems Technology*, **2:1**, pp. 42–45.

- JAMES, B. and G. F. BRYANT (1995): "A parametrization for automatic loop-by-loop multivariable controller design." In *34th IEEE Conference on Decision and Control*. New Orleans, LA.
- JOHANSSON, K. H. (1997): *Relay feedback and multivariable control*. PhD thesis ISRN LUTFD2/TFRT--1048--SE, Department of Automatic Control, Lund Institute of Technology, Lund, Sweden.
- JOHANSSON, K. H. and J. L. R. NUNES (1997): "A multivariable laboratory process with an adjustable zero." Submitted to 17th American Control Conference.
- LUYBEN, W. L. (1986): "Simple method for tuning SISO controllers in multivariable systems." *Ind. Eng. Chem. Process Des. Dev.*, **25**, pp. 654–660.
- MACIEJOWSKI, J. M. (1989): *Multivariable Feedback Design*. Addison-Wesley, Reading, MA.
- MAYNE, D. Q. (1979): "Sequential design of linear multivariable systems." *Proc. IEE*, **126:6**, pp. 568–572.
- MORARI, M. and E. ZAFIRIOU (1989): *Robust Process Control*. Prentice-Hall, Englewood Cliffs, NJ.
- NIEDERLINSKI, A. (1971): "A heuristic approach to the design of linear multivariable interacting control systems." *Automatica*, **7**, pp. 691–701.
- PALMOR, Z. J., Y. HALEVI, and N. KRASNEY (1995): "Automatic tuning of decentralized PID controllers for TITO processes." *Automatica*, **31:7**, pp. 1001–1010.
- PERSSON, P. (1992): *Towards Autonomous PID Control*. PhD thesis ISRN LUTFD2/TFRT--1037--SE, Department of Automatic Control, Lund Institute of Technology, Lund, Sweden.
- SCHEI, T. S. (1992): "A method for closed loop automatic tuning of PID controllers." *Automatica*, **28:3**, pp. 587–591.
- SCHEI, T. S. (1994): "Automatic tuning of PID controllers based on transfer function estimation." *Automatica*, **30:12**, pp. 1983–1989.
- SEBORG, D. E., T. F. EDGAR, and D. A. MELLICHAMP (1989): *Process Dynamics and Control*. Wiley, New York, NY.
- SERON, M. M., J. H. BRASLAVSKY, and G. C. GOODWIN (1997): *Fundamental Limitations in Filtering and Control*. Springer-Verlag.

- SHAKED, U. and A. G. J. MACFARLANE (1977): "Design of linear multivariable systems for stability under large parameter uncertainty." In ATHERTON, Ed., *Fourth IFAC International Symposium on Multivariable Technological Systems*. Fredericton, Canada.
- SHEN, S.-H. and C.-C. YU (1994): "Use of relay-feedback test for automatic tuning of multivariable systems." *AIChE Journal*, **40:4**, pp. 627–646.
- SHINSKEY, F. G. (1981): *Controlling Multivariable Processes*. Instrument Society of America, Research Triangle Park, NC.
- TOH, K.-A. and R. DEVANATHAN (1993): "An expert autotuner for multiloop SISO controllers." *Control Eng. Practice*, **1:6**, pp. 999–1008.
- VASNANI, V. U. (1994): *Towards Relay Feedback Auto-Tuning of Multi-Loop Systems*. PhD thesis, National University of Singapore.
- WANG, Q. G., B. ZOU, T. H. LEE, and Q. BI (1997): "Auto-tuning of multivariable PID controllers from decentralized relay feedback." *Automatica*, **33:3**, pp. 319–330.
- ZAMES, G. (1981): "Feedback and optimal sensitivity: Model reference transformations, multiplicative seminorms and approximate inverses." *IEEE Transactions on Automatic Control*, **AC-26**, pp. 301–320.
- ZGORZELSKI, P., H. UNBEHAUEN, and A. NIEDERLINSKI (1990): "A new simple decentralized adaptive multivariable regulator and its application to multivariable plants." In *IFAC 11th Triennial World Congress*, pp. 381–386. Tallinn, Estonia.
- ZHUANG, M. and D. P. ATHERTON (1994): "PID controller design for a TITO system." *IEE Proc. Control Theory Appl.*, **141:2**, pp. 111–120.
- ZIEGLER, J. G. and N. B. NICHOLS (1942): "Optimum settings for automatic controllers." *Trans. ASME*, **64**, pp. 759–768.

Concluding Remarks

Several problems related to relay feedback, multivariable control, and automatic tuning were discussed in this thesis. A number of new results were proved, but unsolved problems and important questions were also pointed out. In these concluding remarks we first briefly summarize the main contributions of the thesis and then we discuss various extensions. An affiliation list of the coauthors of the papers is also included.

1. Main Contribution

Relay feedback and multivariable control are two topics in control engineering that present many interesting problems. In the thesis it was demonstrated that it is theoretically challenging to investigate even such an apparently simple system as a scalar linear system with relay feedback. The work was motivated by several applications. In particular, automatic controller tuning played a central role. It was also claimed that widespread industrial use of multivariable control requires attention to several unsolved problems of theoretical as well as of practical nature. Questions related to choice of controller structure and modeling for simple control design were discussed. The main contributions of the thesis are

- analysis of fast oscillations in linear systems with relay feedback;
- a stability condition for a new type of limit cycle in such systems;
- a new result on achievable performance for linear multivariable systems with diagonal feedback;
- a novel multivariable laboratory process with a transmission zero that can be located anywhere on the real axis; and
- an extension of SISO automatic controller tuning to MIMO systems via a relay experiment for retuning individual control loops.

All these issues are important. For example, fundamental limitations in control systems are significant. They identify what properties that limit the achievable performance of a system and they can therefore be used

in process design. It is important to understand the behaviors of relay feedback systems. For example, conventional simulation tools may give a totally wrong representation of the fast oscillations. Furthermore, there exists no exact condition when the automatic tuning method works.

2. Ideas for Future Work

In this section we propose research problems that are natural extensions of the results presented in the thesis. Some general problems concerning relay feedback and multivariable control are mentioned and a particular generalization of a result in Paper 1 is discussed.

Relay feedback

There exist few results that describe the behavior of switched systems, although such systems are widely used, for example, in supervisory control and in various hierarchical control systems. A linear system under relay feedback is a special class of switched systems with a simple characteristic. It is natural to ask similar questions for nonlinear systems under relay feedback as was done for linear systems in Paper 1 and Paper 2. A nonlinear system under relay feedback is defined by the equations

$$\begin{aligned}\dot{x} &= f(x, u), \\ y &= c(x), \\ u &= -\operatorname{sgn} y,\end{aligned}\tag{3}$$

where f and c are smooth functions. The proof of Theorem 1 in Paper 1 on fast switches was based on a Taylor expansion of the step response of the linear part of the system. Therefore it seems promising to generalize to a local result for the nonlinear counterpart (3). In particular, if f is affine in u , so that $f(x, u) = a(x) + b(x)u$ with smooth functions a and b , then $CA^{\ell+1}x \pm CA^{\ell}B$ studied in the proof of Theorem 1 will be replaced by $L_a^{\ell+1}c(x) \pm L_b L_a^{\ell}c(x)$, where $L_a c$ is the Lie derivative of c along a , see [Isidori, 1989; Nijmeijer and van der Schaft, 1990]. The first non-vanishing Markov parameter $CA^k B$ thus corresponds to $L_b L_a^k c(x)$.

It is interesting to study oscillations in affine nonlinear systems with relay feedback. One problem is to state existence of initial conditions that gives a sequence of consecutive switch times that tends to zero. The answer for the linear case was given in Paper 1, where this was shown to happen only for systems with relative degree one and two. For an affine nonlinear system the relative degree can be defined roughly as the number of differentiations of the output that are needed before the input appears

explicitly, see Chapter 4 in [Isidori, 1989]. For systems with relative degree one, a first-order sliding mode occurs if the vector fields on both sides of the switch surface $S = \{x \in \mathbf{R}^n : c(x) = 0\}$ are pointing towards S [Filippov, 1988]. Stability of second-order sliding modes is derived in [Malmberg, 1998]. For third-order sliding modes a natural approach seems to be to transform the relay feedback system in a neighborhood of a considered point x^0 into

$$\begin{aligned}
 \dot{z}_1 &= z_2, \\
 \dot{z}_2 &= z_3, \\
 \dot{z}_3 &= a_1(z) + b(z)u, \\
 \dot{z}_4 &= a_2(z), \\
 &\vdots \\
 \dot{z}_n &= a_{n-2}(z), \\
 y &= z_1, \\
 u &= -\operatorname{sgn} y.
 \end{aligned} \tag{4}$$

This is possible if the system has relative degree three in a neighborhood of x^0 , see Proposition 4.1.4 in [Isidori, 1989]. Equation (4) can be analyzed similar to the linear system in Paper 1. The idea is that a sign shift in u has to propagate through three integrators, which was shown to be unstable under relay feedback in Paper 1. Therefore, it is a reasonable conjecture that under mild assumptions the nonlinear affine systems of relative degree three and higher do not yield multiple fast switches.

It is a challenging problem to develop analysis and simulation tools for hybrid systems. Using a recent simulation tool [Andersson, 1994], new phenomena in dynamical systems with a discrete state were shown in the thesis. In systems with several relays, the intersection of switch surfaces gives possibility to new behaviors that remain to be analyzed [Alexander and Seidman, 1995]. For large hybrid systems, like the hierarchical hybrid control system studied in connection to intelligent vehicle highway systems [Varaiya, 1993], other types of simulation tools have been developed [Bodbole *et al.*, 1994].

Multivariable control

Much effort should be spent to close the gap between practical and theoretical multivariable control. This can be done (1) by development of better theoretical understanding of existing industrial multivariable methods and (2) by experimenting with academic MIMO methods in practice.

An example of theoretical investigation of an existing method is the analysis of the relative gain array (RGA). The RGA was introduced in

[Bristol, 1966] as a simple tool for control structure design and was developed from heuristic reasoning. Recently some of its properties have been investigated by relating the RGA to theoretical control performance measures, for example, see [Nett and Manousiouthakis, 1987; Morari and Zafriou, 1989; Hovd, 1992]. Some conclusions about applicability of RGA analysis for systems with RHP zeros were drawn in Paper 3 and in [Manousiouthakis *et al.*, 1986]. From the framework in Paper 3, it appears possible to modify the RGA to better handle a broader range of systems such as those with bandwidth limitations, see [Arkun, 1987] and [Johansson, 1996] for two different approaches.

There are many ways to improve the practical use of multivariable design methods. All model-based design methods depend on efficient and reliable modeling and identification methods. Paper 5 provided a step in this direction, by presenting a simple and robust experiment for identifying part of the dynamics of a multivariable plant. However, more work has to be done to combine this method with control design.

The derivation of multivariable performance limitations caused by a certain controller structure or control design method is an interesting problem. Some progress was made in the thesis. An open problem is to define a criteria to judge the relative merits of centralized and decentralized control. Some preliminary results on this subject in connection to two applications are given in [Freudenberg and Middleton, 1996]. A discussion of the performance deterioration due to a RHP zero for decentralized and centralized designs was made in Paper 3.

The performance limitations given in Section 2 of the introduction and in Paper 3 are conservative. It is, however, possible to reduce the conservativeness by imposing shapes on the bounds of the sensitivity function and the complementary sensitivity function. Some rules of thumb for the choice of closed-loop bandwidth using this approach was derived in [Middleton, 1991] for scalar systems. Multivariable extensions, which relate to both process and controller structure, would be useful. Another open problem is performance limitations for systems with saturation constraints.

The question whether there are any potential benefits of using a hybrid controller for a linear system is asked in [Feuer *et al.*, 1997]. The question is not answered in general, but it is shown through examples that some linear systems have inherent properties that cannot be removed even with a hybrid controller. The problem formulation gives a glance at the open field of hybrid control.

3. References

- ALEXANDER, J. C. and T. I. SEIDMAN (1995): "Sliding modes in intersecting switching surfaces." Unpublished manuscript.
- ANDERSSON, M. (1994): *Object-Oriented Modeling and Simulation of Hybrid Systems*. PhD thesis ISRN LUTFD2/TFRT--1043--SE, Department of Automatic Control, Lund Institute of Technology, Lund, Sweden.
- ARKUN, Y. (1987): "Dynamic block relative gain and its connection with the performance and stability of decentralized control structures." *Int. J. Control*, **46:4**, pp. 1187–1193.
- BODBOLE, D. N., J. LYGEROS, and S. SASTRY (1994): "Hierarchical hybrid control: a case study." In *IEEE Conference on Decision and Control*, pp. 1592–1597. Lake Buena Vista, FL.
- BRISTOL, E. (1966): "On a new measure of interaction for multivariable process control." *IEEE Transactions on Automatic Control*, **11**, p. 133.
- FEUER, A., G. C. GOODWIN, and M. SALGADO (1997): "Potential benefits of hybrid control for linear time invariant plants." In *16th American Control Conference*. Albuquerque, NM.
- FILIPPOV, A. F. (1988): *Differential Equations with Discontinuous Right-hand Sides*. Kluwer Academic Publishers.
- FREUDENBERG, J. and R. MIDDLETON (1996): "Design rules for multivariable feedback systems." In *35th IEEE Conference on Decision and Control*, pp. 1980–1985. Kobe, Japan.
- HOVD, M. (1992): *Studies on control structure selection and design of robust decentralized and SVD controllers*. PhD thesis, University of Trondheim, Norway.
- ISIDORI, A. (1989): *Nonlinear Control Systems*, second edition. Springer-Verlag.
- JOHANSSON, K. H. (1996): "Performance limitations in coordinated control." In *EURACO Workshop on Robust and Adaptive Control of Integrated Systems*. Munich, Germany.
- MALMBORG, J. (1998): "Hybrid control systems." Ph.D. thesis, to appear.
- MANOUSIOUTHAKIS, V., R. SAVAGE, and Y. ARKUN (1986): "Synthesis of decentralized process control structures using the concept of block relative gain." *AIChE Journal*, **32:6**, pp. 991–1003.

Concluding Remarks

- MIDDLETON, R. H. (1991): "Trade-offs in linear control system design." *Automatica*, **27:2**, pp. 281–292.
- MORARI, M. and E. ZAFIRIOU (1989): *Robust Process Control*. Prentice-Hall, Englewood Cliffs, NJ.
- NETT, C. N. and V. MANOUSIOUTHAKIS (1987): "Euclidean condition and block relative gain—connections, conjectures, and clarifications." *IEEE Transactions on Automatic Control*, **32:5**, pp. 405–407.
- NIJMEIJER, H. and A. J. VAN DER SCHAFT (1990): *Nonlinear Dynamical Control Systems*. Springer-Verlag, New York, NY.
- VARAIYA, P. (1993): "Smart cars on smart roads: Problems of control." *IEEE Transactions on Automatic Control*, **38:2**, pp. 195–207.

4. Coauthor Affiliations

Karl Johan Åström
Dept. of Automatic Control
Lund Institute of Technology
Lund, Sweden
kja@control.lth.se

Andrey Barabanov
Saint-Petersburg State University
Saint-Petersburg, Russia
andrey.barabanov@pobox.spbu.ru

Greyham F. Bryant
Centre for
Process Systems Engineering
Imperial College
London, United Kingdom
g.bryant@ic.ac.uk

Ben James
Exposure Management
Bank of America
London, United Kingdom
113277.2673@compuserve.com

Anders Rantzer
Dept. of Automatic Control
Lund Institute of Technology
Lund, Sweden
rantzer@control.lth.se

José Luís Rocha Nunes
Dept. of Informatics
University of Coimbra
Coimbra, Portugal
jnunes@student.dei.uc.pt



ISSN 0280-5316
ISRN LUTFD2/TFRT--1048--SE