



LUND UNIVERSITY

Piecewise Linear Control Systems

Johansson, Mikael

1999

Document Version:

Publisher's PDF, also known as Version of record

[Link to publication](#)

Citation for published version (APA):

Johansson, M. (1999). *Piecewise Linear Control Systems*. [Doctoral Thesis (monograph), Department of Automatic Control]. Department of Automatic Control, Lund Institute of Technology (LTH).

Total number of authors:

1

General rights

Unless other specific re-use rights are stated the following general rights apply:

Copyright and moral rights for the publications made accessible in the public portal are retained by the authors and/or other copyright owners and it is a condition of accessing publications that users recognise and abide by the legal requirements associated with these rights.

- Users may download and print one copy of any publication from the public portal for the purpose of private study or research.
- You may not further distribute the material or use it for any profit-making activity or commercial gain
- You may freely distribute the URL identifying the publication in the public portal

Read more about Creative commons licenses: <https://creativecommons.org/licenses/>

Take down policy

If you believe that this document breaches copyright please contact us providing details, and we will remove access to the work immediately and investigate your claim.

LUND UNIVERSITY

PO Box 117
221 00 Lund
+46 46-222 00 00

Piecewise Linear Control Systems

Piecewise Linear Control Systems

Mikael Johansson

Lund 1999

To Laurence

Published by Department of Automatic Control
Lund Institute of Technology
Box 118
SE-221 00 LUND
Sweden

ISSN 0280-5316
ISRN LUTFD2/TFRT-1052-SE

©1999 by Mikael Johansson
All rights reserved

Printed in Sweden by Lunds Offset AB
Lund 1999

Contents

Acknowledgments	7
Financial Support	8
1. Introduction	9
1.1 Nonlinearity, Uncertainty and Computation	10
1.2 Piecewise Linear Systems	11
1.3 System Analysis using Lyapunov Techniques	13
1.4 Lyapunov Analysis of Piecewise Linear Systems	16
1.5 Thesis Outline	17
2. Piecewise Linear Modeling	21
2.1 Model Representation	21
2.2 Solution Concepts	26
2.3 Uncertainty Models	28
2.4 Modularity and Interconnections	33
2.5 Comments and References	34
3. Structural Analysis	39
3.1 Equilibrium Points and Static Gain Analysis	39
3.2 Detection of Instabilities	43
3.3 Constraint Verification	44
3.4 Detecting Attractive Sliding Modes	46
3.5 Comments and References	49
4. Lyapunov Stability	51
4.1 Exponential Stability	51
4.2 Quadratic Stability	54
4.3 Conservatism of Quadratic Stability	58
4.4 From Quadratic to Piecewise Quadratic	60
4.5 Interlude: Describing Partition Properties	63
4.6 Piecewise Quadratic Lyapunov Functions	68
4.7 Analysis of Uncertain Systems	75
4.8 Improving Computational Efficiency	77

4.9	Piecewise Linear Lyapunov Functions	84
4.10	A Unifying View	89
4.11	Systems with Attractive Sliding Modes	91
4.12	Local Analysis and Convergence to a Set	95
4.13	Comments and References	98
5.	Dissipativity Analysis	101
5.1	Dissipativity Analysis via Convex Optimization	102
5.2	Computation of L_2 -induced Gain	104
5.3	Estimation of Transient Energy	106
5.4	Dissipative Systems with Quadratic Supply Rates	108
5.5	Comments and References	111
6.	Controller Design	113
6.1	Piecewise Linear Quadratic Control	113
6.2	Comments and References	118
7.	Extensions	121
7.1	Fuzzy Logic Systems	121
7.2	Hybrid Systems	127
7.3	Smooth Nonlinear Systems	134
7.4	Automated Partition Refinements	136
7.5	Comments and References	139
8.	Computational Issues	141
8.1	Computing Constraint Matrices	142
8.2	On the S-procedure in Piecewise Quadratic Analysis	150
8.3	A Matlab Toolbox	155
8.4	Comments and References	165
9.	Concluding Remarks	167
	Summary of Contributions	167
	Open Problems and Ideas for Future Research	170
A.	Proofs	173
A.1	Proofs for Chapter 2	173
A.2	Proofs for Chapter 3	175
A.3	Proofs for Chapter 4	175
A.4	Proofs for Chapter 8	179
B.	Additional Details on Examples	183
B.1	Further Details on the Min-Max System	183
C.	Bibliography	187

Acknowledgments

Behind every doctoral thesis lie years of hard work. It is therefore a great pleasure for me to have the opportunity to thank those who have given me the support and encouragement to write this thesis.

I started my PhD studies in 1994, partly because of a strong interest in automatic control and partly because I found the Department of Automatic Control at Lund University such an extraordinary scientific environment. When I now put the final words to this thesis I am very happy to see that this friendly and creative atmosphere prevails. My first thanks therefore go to all the people at the department for creating such a great place. In particular, I would like to thank Professor Karl Johan Åström for making it all possible. His dynamic leadership fuels creativity and makes research in control exciting and rewarding.

I would like to express my sincere gratitude to my advisors, Karl-Erik Årzén and Anders Rantzer, who have guided me through my PhD studies. They are both very skilled researchers and it has been a great privilege to work with them. They have always been enthusiastic and encouraging, and have given me a lot of freedom in conducting my research. Thank you both! A special thanks to Andrey Ghulchak who has been a great asset during the completion of this thesis. I am also indebted to Mats Åkesson, Ulf Jönsson, Lennart Andersson and Rolf Johansson for reading different versions of the manuscript and suggesting many improvements.

Many thanks to all the PhD students at the department for making the everyday work so enjoyable. In particular, I would like to thank Mats Åkesson who has been a great roommate during the past two years.

My PhD studies have included two research visits at foreign universities. These visits have provided useful perspectives and have had profound impact on me. I would like to thank Professor Li-Xin Wang at the Hong Kong University of Science and Technology where I spent three early months of my PhD studies, and Professor Romeo Ortega at SUPÉLEC where I spent six rewarding months during 1998.

I would also like to express my gratitude to friends for giving me perspective on what I do, and to my family for supporting me in whatever I choose to do. The encouragement from my parents has been invaluable.

My final thanks go to Laurence for her love, patience and support.

Mikael

Financial Support

The work resulting in this thesis has been sponsored by a number of sources over the years. The financial support of Volvo, ABB and the Institute of Applied Mathematics (ITM), the Swedish Research Council for Engineering Sciences (TFR) under grant 95-759 and the Esprit LTR project FAMIMO is gratefully acknowledged.

1

Introduction

Computer control systems are becoming an increasingly competitive factor in a wide range of industries. Many products now achieve their competitive edge due to the complex functionality provided in algorithms and software. As more and more product value is invested in software, there is a strong desire to formally verify its correctness. System analysis, which many engineers may previously have regarded as an academic exercise, is becoming instrumental for coping with complexity and guaranteeing correctness of advanced software. At the same time, increased performance demands over wide operating ranges force control engineers to move from linear to nonlinear controllers. More and more often, linear techniques fall short in analysis of control systems.

Competition also forces faster and more effective product development. Today, more and more control designs are based on mathematical process models, and their performance is thoroughly tested in simulations before full scale trials. This reduces expensive and time consuming experimentation and tuning on prototype products. Working with mathematical models, however, always involves uncertainty. There is always a mismatch between what is predicted by mathematical models and what can be observed in reality. It then becomes important to account for uncertainty in the analysis, in order to grant that the results are valid also in reality. The wide availability of simulation models makes it very attractive to develop design and verification methods that are based on numerical computations. Future software environments for control design are likely to include some analysis features, such as stability analysis and gain computations.

The aim of this thesis is to develop computational algorithms for analysis of nonlinear and uncertain systems. In particular, we focus on systems with piecewise linear dynamics and extend some aspects of the celebrated theory for linear systems and quadratic criteria to piecewise linear systems and piecewise quadratic criteria.

1.1 Nonlinearity, Uncertainty and Computation

Nonlinear systems are much harder to analyze than linear systems, and nonlinear controllers are considerably less well understood than their linear counterparts. Linearity means that local properties also hold globally. Nonlinearity is the absence of this property, meaning that a local analysis may say nothing about the global behavior of the system. In order to arrive at strong results for nonlinear systems one typically needs to constrain the class of system under consideration. A key problem in systems theory is then to find classes of systems that are practically relevant, yet allow to a tractable mathematical analysis. This usually involves approximations of physical models that brings some structure into the problem. Such structure may for example be linearity, smoothness or convexity. What structure to enforce on the model is typically dependent on the mathematical analysis tools at hand. Consider for example the work on nonlinear systems on the form

$$\dot{x} = f(x) + g(x)u$$

By assuming that $f(x)$ and $g(x)$ are sufficiently smooth, and exploiting linearity in u it is possible to invoke tools from differential geometry to derive a strong toolset for controller design [51, 101]. This thesis takes another route and focuses on convexity. The motivation for this choice is a desire to base the analysis on efficient numerical computations [19, 99].

Uncertainty is one of the main motivations for feedback control. Most control design methodologies are based on mathematical models of the process to be controlled. Uncertainty describes the differences between the behavior of our mathematical models and reality. These discrepancies are typically due to uncertain parameters, unmodeled components or disturbances. The differences between mathematical models and reality raises the question whether a design that is derived from the mathematical models will actually work in reality. Feedback control can reduce the effects of these uncertainties, and in many cases it renders the performance of the controlled system invariant under small process variations. However, if the process variations become too large, the feedback may force the system to become unstable. It is therefore important to account for uncertainties in the design, so that stability and performance can be granted for the real system.

The amazing advances in computer technology have made high performance computers broadly available. Large parts of the development process for a control systems can nowadays be performed within one single piece of software. Not only are today's control engineers skilled users of advanced software, but large investments have also been put on developing mathematical models for their applications. This motivates research

in computational methods for analysis and design of control systems. The recent progress in software for convex optimization is a promising foundation for efficient numerical design methods. Aiming at a computational analysis one should be aware of the fundamental limitations of computations. Many analysis problems, even for mildly nonlinear systems, have been shown to be intractable or even impossible to solve by computations [18]. However, this is not reason enough to refrain from further research. It is often possible to derive efficient algorithms that work well in most cases, or deliver solutions that are close to optimal.

This thesis considers systems that are piecewise linear. By the term piecewise linear we refer to a dynamic system that has different linear dynamics in different regions of the continuous state space. Piecewise linear systems capture many of the most common nonlinearities in engineering systems, and are powerful also for approximation of more general nonlinear systems. Moreover, they enjoy certain properties that will allow us to develop an efficient computer-aided analysis, taking standard models of uncertainty into account.

1.2 Piecewise Linear Systems

We consider piecewise linear systems on the form

$$\dot{x} = A_i x + a_i \quad \text{for } x \in X_i.$$

Here $\{X_i\}$ is a partition of the state space into operating regimes. The dynamics in each region is described by a linear (or rather affine) dynamics. Piecewise linear systems have a wide applicability in a range of engineering sciences. Some of the most common nonlinear components encountered in control systems such as relays and saturations are piecewise linear. Diodes and transistors, key components in even the simplest electronic circuits, are naturally modeled as piecewise linear. Many advanced controllers, notably gain scheduled flight control systems, are based on piecewise linear ideas. The construction of a globally valid nonlinear model from locally valid linearizations is easy to understand and widely accepted among engineers.

Some of the first investigations of piecewise linear systems in the control literature can be traced back to Andronov [2], who used tools from Poincaré to investigate oscillations in nonlinear systems. The practical benefits of piecewise linear servomechanisms were also noticed early on [124]. An interesting early attempt to develop a qualitative understanding of piecewise linear systems were made by Kalman [73]. He considered a saturated system as a series of linear regions in the state space, separated

by switching boundaries. This is also the view of piecewise linear systems that we will adopt in this thesis. By identifying the singular points of the dynamics in the different regions it was possible to make qualitative statements about the global dynamics. It would take several decades before these ideas were refined and developed into more complete analysis tools. In the meantime, developments on piecewise linear systems appeared almost exclusively as work on linear systems interconnected with static nonlinearities such as relays, saturations and friction. Since these systems turned out to be very challenging to analyze, these directions have remained very active areas of research. Several theoretical results with broader applications has come out of these lines of research, notably in the work on optimal control [40] absolute stability [115] and differential equations with discontinuous right hand sides [39].

It is fair to say that it was the circuit theory community that first recognized piecewise linear systems as an interesting system class in its own right. Driven by the need for efficient simulation and analysis of large-scale circuits with diodes and other piecewise linear elements, a considerable research effort has focused on efficient representation of piecewise linear systems [30, 139] The analysis problems have mainly been concerned with static problems and DC analysis [144], while the more complicated dynamic behaviors have remained largely unattended.

Triggered by the recent increase in the use of switched and hybrid controllers, two conceptually different approaches to analysis of general piecewise linear dynamical systems have emerged. For discrete time dynamics, some attempts have been made to formulate analysis procedures based on properties of affine mappings and polyhedral sets [131]. This approach captures some unique features of discrete time piecewise linear systems, and similar ideas have been used for robustness analysis of piecewise linear systems [75]. For continuous time dynamics, Pettit has developed a method for qualitative analysis of piecewise linear systems that is based on vector field considerations [110]. The approach can be seen as a multidimensional extension of phase portrait techniques and gives a qualitative picture of the overall dynamics, indicating sliding modes, probable limit cycles and instabilities. In some sense this approach represents the most recent extensions and refinements of the work initiated by Kalman in the 50's.

This thesis focuses on quantitative analysis of piecewise linear dynamic systems. Stability and gain computations are typical examples. Today, such results exist almost exclusively for specific piecewise linear components. For more general piecewise linear systems, there is a clear shortage of analysis tools. The results developed in this thesis are some of the first steps towards a more complete theory for general piecewise linear systems.

1.3 System Analysis using Lyapunov Techniques

Stability is one of the most fundamental properties of dynamic systems, and many concepts have been introduced for the mathematical study of stability. Irrespectively of the precise definition that we choose to use, stability is the intuitive property that a system does not explode. There is a close relation between stability and notions of energy.

Stability analysis of dynamic systems was pioneered by Lyapunov [89, 90]. The intuition behind the results came from energy considerations. The key idea was that if every motion of a system has the property that its energy decreases with time, the system must come to rest irrespectively of its initial state. To make the argument more rigorous, Lyapunov required that the energy measure $V(x(t))$ of a motion $x(t)$ should be proper in the sense that $V(0) = 0$ and

$$V(x) > 0 \quad \forall x \neq 0.$$

The requirement that the V should be decreasing along all trajectories of the system $\dot{x} = f(x)$ takes the form

$$\dot{V}(x) = \frac{\partial V(x)}{\partial x} f(x) < 0 \quad \forall x \neq 0.$$

Together, these conditions are the well known conditions for Lyapunov stability, and a function $V(x)$ that satisfies the two inequalities is called a Lyapunov function for the system.

Energy measures are very powerful tools in systems theory, and similar functions appear throughout dynamical systems analysis; in gain computations and in the design of optimal control laws. The Lyapunov function $V(x)$ that satisfies the above conditions is an abstract measure of the system energy. For some systems, physical insight may hint at the appropriate energy function. For other systems, the choice is much less obvious. To this day, the main obstacle in the use of Lyapunov's method is the nontrivial step of finding an appropriate Lyapunov function.

The situation is much simpler for linear systems, $\dot{x} = Ax$. Lyapunov showed that for asymptotic stability of linear systems it is both necessary and sufficient that there exists a quadratic Lyapunov function $V(x) = x^T P x$. The conditions that such a function be proper, and that its value decreases along all motions of the linear systems result in the well-known Lyapunov inequalities

$$P > 0, \quad A^T P + P A < 0.$$

With today's terminology, we would say that these conditions are linear matrix inequalities (LMIs) in P . Since the inequalities admit an explicit solution, this view should not be adopted until almost a century later. Indeed, by picking an arbitrary positive definite matrix $Q = Q^T > 0$, stability can be assessed from the solution P to the system of linear equalities

$$A^T P + PA = -Q.$$

The system is asymptotically stable if and only if P is positive definite.

Encouraged by these results, several researchers tried to find results of similar elegance for systems with simple nonlinearities. In particular, much research was focused on the absolute stability problem, which considers a linear system interconnected with a static memoryless nonlinearity. The absolute stability problem nurtured several important theoretical developments. Two beautiful examples are the circle criteria [152] and the Popov criteria [113]. These results give frequency domain conditions on the transfer function of the linear system that are sufficient for existence of certain Lyapunov functions for the interconnection. Such frequency domain criteria give valuable insight and were particularly important before the computer era, since they allowed for simple geometrical verification rather than solving difficult matrix inequalities in the time domain.

Automatic control went through a drastic change in the 1960's with the advent of state space theory. The development was fueled by demanding applications (the space race), new technology (computers), and a strong influence of mathematics. This led to the development of optimal control. As the name indicates, the field of optimal control does not only aim at merely providing a satisfactory controller, but it actually tries to achieve the best performance possible. The merit of a control law is often expressed as some integral criteria

$$\int_0^{\infty} L(x(t), u(t)) dt.$$

Bellman [10] showed that optimal control laws u for the system $\dot{x} = f(x, u)$ could be characterized in terms of solutions V to the Hamilton-Jacobi-Bellman equation

$$\inf_u \left(\frac{\partial V(x)}{\partial x} f(x) + L(x, u) \right) = 0.$$

Notice that for the optimal solutions we have $\dot{V} = -L(x, u)$ which is typically negative. Hence $V(x)$ may serve as a Lyapunov function for the closed loop systems. Similar to the Lyapunov inequalities, the Hamilton-Jacobi-Bellman equation is notoriously hard to solve in general. Many

numerical methods have been devised for the solution of optimal control problems, but they tend to suffer from computational explosion. This limits practical applications of optimal control theory to systems of low state dimension, or to the optimization of trajectories rather than feedback laws.

An important exception is the combination of linear systems and quadratic criteria. In this case, the dynamics is on the form $\dot{x} = Ax + Bu$, and the criterion takes the form

$$\int_0^{\infty} x^T Qx + 2u^T Cx + u^T Ru dt.$$

The first solution to this problem was due to Kalman [74] who showed that the optimal controller is a linear state feedback. In the early 1970's, Willems gave several equivalent characterizations of the optimal solution [148]. One of these characterizations was that there should exist a symmetric matrix $P = P^T$ that satisfies the linear matrix inequality condition

$$\begin{bmatrix} A^T P + PA + Q & PB + C^T \\ B^T P + C & R \end{bmatrix} \geq 0.$$

However, the numerical methods at hand made it more attractive to consider an alternative characterization in terms of an algebraic matrix equation which could be solved using numerical linear algebra. Willems also showed that many other questions involving quadratic criteria, such as computations of induced gains, can be characterized by Lyapunov-like functions (called storage functions) [149]. For linear systems the existence conditions for such functions take the form of linear matrix inequalities.

A decade later, numerical methods for convex optimization started to get widely available. In their 1982 study of the absolute stability problem (now extended to multiple nonlinearities) [117], Pyatnitskii and Skorodinskii derived a solution in terms of LMIs and gave a numerical algorithm that is guaranteed to find the solution, if it exists.

The early methods for convex optimization had high complexity. A breakthrough came in 1984, when Karmarkar introduced the interior point method for linear programming [76] This method had polynomial complexity and worked well in practice. The method was later extended to general convex programming by Nesterov and Nemirovski [99]. Promoted by efficient software [42, 151, 143] and excellent tutorial texts [19, 122] researchers have started to accept a linear matrix inequality condition as a solution of similar value to an analytical result. Moreover, linear matrix inequalities have turned out to be convenient for the formulation of a wide range of important control problems, and the interest in these methods has soared.

1.4 Lyapunov Analysis of Piecewise Linear Systems

Lyapunov techniques are very useful in system analysis. Not only do they allow stability analysis and gain computations, but they are also useful in the solution of optimal control problems. This makes Lyapunov techniques a natural basis for analysis of piecewise linear systems. The main obstacle to a direct application of the existing techniques is the nontrivial step of finding the appropriate Lyapunov function. Hence, methods for efficient Lyapunov function construction are of fundamental importance in a useful theory for piecewise linear systems.

At the outset of this thesis work, the prevailing approach was to use quadratic Lyapunov functions. Such functions could be computed by solving an LMI-problem in terms of multiple Lyapunov inequalities,

$$P > 0 \quad A_i^T P + P A_i < 0, \quad i = 1, \dots, L.$$

This approach has its roots in work on linear uncertain systems [48, 20]. An important development was the paper [142] that showed that the cost for solving the multiple LMIs does not need to be much bigger than the cost of solving a single LMI (see also [19]). Unfortunately, these LMI conditions are often found to be conservative when applied to piecewise linear systems. One reason for this is that the stability conditions are derived for linear uncertain (time-varying) systems. Hence, they do not take into account the fact that a certain dynamics is only used in a specific part of the state space. Another reason is that many systems do not admit a quadratic Lyapunov function.

A natural extension for piecewise linear systems is to consider Lyapunov functions that are piecewise quadratic,

$$V(x) = \begin{bmatrix} x \\ 1 \end{bmatrix}^T \bar{P}_i \begin{bmatrix} x \\ 1 \end{bmatrix} \quad \text{for } x \in X_i.$$

These functions have different quadrature in different operating regimes, and are obviously much more powerful than globally quadratic functions. One of the main contributions of this thesis is to show how the search for piecewise quadratic Lyapunov functions can be formulated as a convex optimization problem in terms of LMIs. The analysis makes use of the fact that each system matrix A_i only describes the dynamics in a certain part of the state space. The stability conditions take the form

$$\bar{P}_i - \bar{R}_i > 0, \quad \bar{A}_i^T \bar{P}_i + \bar{P}_i \bar{A}_i + \bar{S}_i < 0, \quad i = 1, \dots, L.$$

where \bar{R}_i and \bar{S}_i are matrices with a particular structure. These matrices express the fact that the inequalities are only required to hold for certain

x (those x such that $x \in X_i$). The stability conditions are linear matrix inequalities in \bar{P}_i , \bar{R}_i and \bar{S}_i .

Based on this result, it is possible to extend the successful theory of linear systems and quadratic constraints to piecewise linear systems with piecewise quadratic constraints. This allows us to compute induced gains of piecewise linear systems and to solve optimal control problems. Moreover, since we are working with quadratic integrals, it is possible to adopt the standard models for uncertainty. An important feature is that the analysis tasks are formulated as LMI conditions that can be solved using efficient numerical computations. Most results in this thesis have been packaged into computational algorithms, allowing several important analysis problems to be solved “at the press of a button”.

Caveat. This thesis does not present a complete theory for piecewise linear systems. The aim of this work has been to provide some first methods for quantitative analysis of more general piecewise linear systems. Many interesting problems remain open, and more precise results are likely to be found for specific classes of piecewise linear systems. However, the possibility to automate several important analysis tasks for nonlinear and uncertain systems using efficient numerical computations is an important contribution. I sincerely hope that this work will encourage further research on piecewise linear systems.

1.5 Thesis Outline

This thesis treats seven aspects of piecewise linear control systems

1. Piecewise Linear Modeling
2. Structural Analysis
3. Lyapunov Stability
4. Dissipativity Analysis
5. Controller Design
6. Extensions
7. Computational Issues

Each theme corresponds to one chapter of the thesis.

Theme 1 deals with modeling of piecewise linear systems. It is shown how uncertainty models for linear systems can be extended to piecewise linear systems. These extensions give new insight in the classical modeling trade-off between computational complexity and fidelity of the model.

It is shown how series, parallel and feedback interconnection of piecewise linear systems yield piecewise linear systems. Such properties open up for many interesting trade-offs in input-output analysis of piecewise linear systems.

The second theme is to show how some important structural properties of piecewise linear systems can be verified via linear programming. This includes equilibrium point computations, state transformations, detection of attractive sliding modes and constraint verification. These results are useful for ruling out degeneracies in the model, and are important complements to the quantitative computations derived in the sequel.

The third theme is stability analysis of piecewise linear systems using Lyapunov function techniques. This chapter contains many of the main results of the thesis. A key idea is the use of Lyapunov functions that are piecewise quadratic. It is shown how piecewise quadratic Lyapunov functions can be computed via convex optimization in terms of linear matrix inequalities (LMIs). Piecewise quadratic Lyapunov functions are substantially more powerful than globally quadratic functions. These novel results are based on a compact parameterization of continuous piecewise quadratic functions and conditional analysis using the S-procedure. Several improvements and trade-offs are discussed that reduce the computation times to a fraction of what was originally required. The parameterization of piecewise quadratic Lyapunov functions is specialized to Lyapunov functions that are piecewise affine. It is shown how these Lyapunov functions can be computed using linear programming. This has some computational advantages over LMI computations used in the construction of piecewise quadratic Lyapunov functions. More importantly, it establishes a unified framework for computation of quadratic, polytopic, piecewise affine and piecewise quadratic Lyapunov functions. Such a unification makes it easier to judge the merits and drawbacks of the different approaches, and to exploit the trade-offs between accuracy in the analysis and computational complexity. The basic computations are extended to systems with attractive sliding modes, and to systems that are not globally uniformly exponentially stable.

Lyapunov-like functions arise in many analysis problems. Based on the previous developments, the fourth theme is to show how many analysis procedures for linear systems using quadratic Lyapunov functions can be extended to piecewise linear systems and Lyapunov functions that are piecewise quadratic. This includes computations of induced gains and verification of dissipation inequalities. These are important developments, since they open up for input-output analysis, allowing properties of complex feedback systems to be estimated from the analysis of simpler subsystems. Another important aspect is that it allows analysis of systems that otherwise do not fit into the piecewise linear framework. An interesting

example is nonlinear systems with time delays.

Theme 5 concerns controller design for piecewise linear systems. It is shown that by considering optimal control problems in terms of Hamilton-Jacobi-Bellman inequalities rather than equalities leads to convex (but infinite dimensional) problems. By restricting the system equations to be piecewise linear and by considering cost functions that are piecewise quadratic, it is then possible to use the machinery from the previous sections to design optimal control laws.

A sixth theme is to show how the basic results for piecewise linear systems can be extended in several directions. Fuzzy systems are popular in many applications but are desperately short of efficient analysis methods. It is also an area where engineers often prefer to tune local controllers “by hand”, but would like to verify system properties before full scale trials. We show how the analysis methods developed for piecewise linear systems extend to fuzzy systems. The area of hybrid control has attracted a large interest in the control community over the past few years. We show how a class of piecewise linear hybrid systems can be analyzed using convex optimization. The approach uses piecewise quadratic Lyapunov functions that have a discontinuous dependence on the discrete state. The main contribution is to formulate the search for these Lyapunov functions in terms of linear matrix inequalities. Finally, we show how the piecewise linear framework can be used for rigorous analysis of smooth nonlinear systems. An important feature of the approach is that a local linear-quadratic analysis near an equilibrium point of a nonlinear system can be improved step by step, by splitting the state space into more regions, thereby increasing the flexibility in the nonlinearity description and enlarging the validity domain for the analysis. In this way, the tradeoff between precision and computational complexity can be addressed directly. We suggest a procedure for automatic partition refinements that uses duality. This procedure increases the flexibility of the Lyapunov function candidate in the regions where it is needed the most.

The aim of this thesis is to develop a computational analysis of piecewise linear systems. The value of these results lies in the facts that stability analysis of reasonably large systems, with several tens of operating regimes, can be made automatically and in a matter of seconds. The final theme is the development of a Matlab toolbox that contains most of the tools developed in this thesis. A set of user-friendly commands makes it easy to describe piecewise linear systems. Stability analysis, gain computations and controller design can then be performed with simplicity and efficiency. The toolbox also includes a simulation engine that treats systems with sliding modes. The toolbox is publically available, free of charge.

A summary of the thesis contributions can be found in Chapter 9.

Publications

The thesis is based on the following publications.

- [1] M. JOHANSSON and A. RANTZER. “Computation of piecewise quadratic Lyapunov functions for hybrid systems.” *IEEE Transactions on Automatic Control*, 1998. Special issue on Hybrid Systems. Also appeared as conference article in the 1997 European Control Conference, Brussels, Belgium. July 1997.
- [2] A. RANTZER and M. JOHANSSON. “Piecewise linear quadratic optimal control.” *IEEE Transactions on Automatic Control*, 1998. Accepted for publication. Also appeared as conference article in the 1997 American Control Conference, Albuquerque, N.M, June 1997.
- [3] M. JOHANSSON, A. RANTZER, and K.-E. ÅRZÉN. “A piecewise quadratic approach to stability analysis of fuzzy systems.” In *Stability Issues in Fuzzy Control*. Springer-Verlag, 1998. To appear.
- [4] M. JOHANSSON, A. RANTZER, and K.-E. ÅRZÉN. “Piecewise quadratic stability of fuzzy systems.” Submitted for journal publication. Also appeared as the conference article “Piecewise quadratic stability of affine Sugeno systems” in the 7th IEEE International Conference on Fuzzy Systems, Fuzz-IEEE, Anchorage, Alaska, May 1998. 1998.
- [5] M. JOHANSSON. “Analysis of piecewise linear systems via convex optimization – a unifying approach.” In *Proceedings of the 1999 IFAC World Congress*, Beijing, China, 1999. To appear.
- [6] M. JOHANSSON and A. RANTZER. “On the computation of piecewise quadratic Lyapunov functions.” In *Proceedings of the 36th IEEE Conference on Decision and Control*, San Diego, USA, December 1997.
- [7] M. JOHANSSON, A. GHULCHAK, and A. RANTZER. “Improving efficiency in the computation of piecewise quadratic Lyapunov functions.” In *Proceedings of the 7th IEEE Mediterranean Conference in Control and Automation*, Haifa, Israel, 1999. To appear.
- [8] M. JOHANSSON, J. MALMBORG, A. RANTZER, B. BERNHARDSSON, and K.-E. ÅRZÉN. “Modeling and control of fuzzy, heterogeneous and hybrid systems.” In *Proceedings of the SiCiCa 1997*, Annecy, France, June 1997.
- [9] S. HEDLUND and M. JOHANSSON. “A toolbox for computational analysis of piecewise linear systems.” Submitted to the 1999 European Control Conference. 1998.

2

Piecewise Linear Modeling

This thesis treats analysis and design of piecewise linear control systems. In this chapter, we lay the foundation for the analysis by presenting the mathematical model on which the subsequent developments will be based. We discuss properties of solutions, and derive an explicit matrix representation of the model. By straightforward extensions of modeling techniques for uncertain linear systems, we show how norm-bounded uncertainties and smooth nonlinearities can be treated rigorously in the piecewise linear framework. Moreover, these extensions give new insight into the classical trade-off between uncertainty and complexity in modeling of dynamical systems. Finally, we note that piecewise linear dynamical systems enjoy important interconnection properties, allowing complicated piecewise linear systems to be constructed from the interconnection of simpler subsystems.

2.1 Model Representation

A piecewise linear dynamical system is a nonlinear system

$$\begin{cases} \dot{x} = f(x, u, t) \\ y = g(x, u, t) \end{cases}$$

whose right-hand side is a piecewise linear function of its arguments. For example, a linear system with saturated input results in system equations that are piecewise linear in the input variable. Linear systems with abrupt changes in parameter values are piecewise linear systems in time (see, for example, the work on jump linear systems [133]). The most common situation, however, is when the system equations are piecewise in the system state. Such a model can for example arise from linearizations of a nonlinear system around different operating points or from interconnections of piecewise linear components and linear systems.

Throughout this thesis, we will understand the term piecewise as piecewise in the system state. With this interpretation, piecewise linear indicates that the state space can be subdivided into a set of regions, X_i , such that the dynamics within each region is affine in x

$$\begin{cases} \dot{x} = A_i x + a_i + B_i u \\ y = C_i x + c_i + D_i u \end{cases} \quad \text{for } x \in X_i.$$

When written in this way, it is clear that a piecewise linear system has two important components; the partition $\{X_i\}$ of the state space into regions, and the equations describing the dynamics within each region. To obtain a good understanding of the global dynamics of such systems, one needs to account for both. Although the term piecewise linear does not impose any restriction on the geometry of the regions, such restrictions are often necessary to impose in order to arrive at useful results. In this thesis, we restrict our attention to *polyhedral piecewise linear dynamical systems*, where the state space is partitioned into convex polyhedra.

While most readers of this thesis probably have a good knowledge of linear [72, 121] and nonlinear [78, 130] dynamical systems, they may be less familiar with polytope theory. Since many results in this thesis are based on properties of polyhedra and polytopes, and a basic orientation in polytope theory may be useful. The texts [27, 157, 123] give a thorough introduction to convex polytopes.

Introductory Examples

Before giving a more precise definition of piecewise linear systems, it is useful to consider some simple examples. One of the simplest piecewise linear control systems is obtained when a linear system is interconnected with a static nonlinearity, such as a saturation or a relay.

EXAMPLE 2.1—ACTUATOR SATURATION IN LINEAR SYSTEMS

Consider a linear system under bounded linear state feedback,

$$\dot{x} = Ax + b \operatorname{sat}(v), \quad v = k^T x.$$

The saturation nonlinearity induces a natural polyhedral partition of the state space. The partition has three cells corresponding to negative saturation (X_1), linear operation (X_2), and positive saturation (X_3) respectively, see Figure 2.1. The dynamics is piecewise linear

$$\dot{x} = \begin{cases} Ax - b & x \in X_1 \\ (A + bk^T)x & x \in X_2 \\ Ax + b & x \in X_3 \end{cases} \quad (2.1)$$

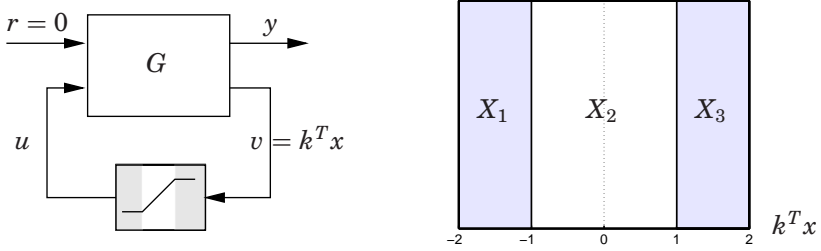

Figure 2.1 A saturated linear feedback (left) induces a piecewise linear system with a polyhedral partition of the state space (right).

In this example, it is natural to let the cells be closed polyhedral sets that only share their common boundaries. Note that the presence of offset terms makes the dynamics affine rather than linear in the state x . \square

The initial motivation to use piecewise linear components in circuit theory was the possibility to approximate nonlinear components in a way that allows for efficient computations. This is also the basic idea behind gain scheduling in modeling and control of dynamic systems. A simple method to obtain an approximation of a smooth function is to evaluate the function on a number of points, and then use linear interpolation to construct the approximant. This was how piecewise linear circuit models were constructed in [50, 103, 29].

EXAMPLE 2.2—APPROXIMATION OF SMOOTH SYSTEMS

The following equations describe a mechanical system with a nonlinear spring and damper.

$$\begin{aligned}\dot{x}_1 &= f_1(x) = x_2 \\ \dot{x}_2 &= f_2(x) = -x_2|x_2| - x_1(1 + x_1^2)\end{aligned}$$

A piecewise linear approximation of this system can be obtained by evaluating the right-hand side of the system equations on the grid shown in Figure 2.2 (left). A piecewise linear approximant can then be constructed from a linear approximation between these points. Figure 2.2 (right) shows the function $f_2(x)$ and the piecewise linear approximation $\hat{f}_2(x)$ obtained by this procedure. \square

In many cases we are more interested in achieving good approximation in all space, rather than the exact reconstruction of the dynamic behavior at isolated points of the state space. Methods for identification of piecewise linear systems from data have been suggested in [14, 129, 98, 26].

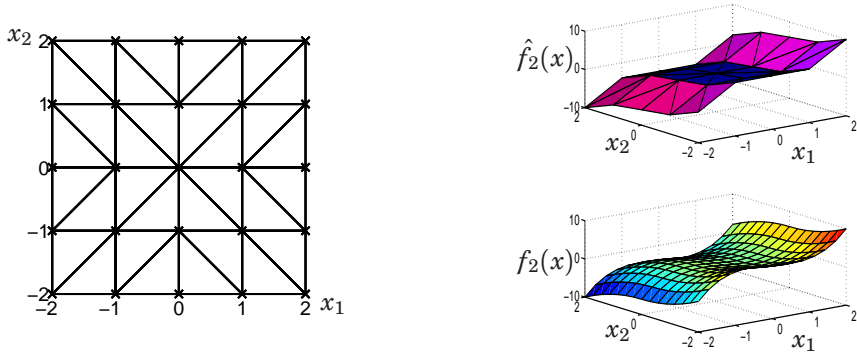

Figure 2.2 Partition (left) induced by the grid points marked with \times , piecewise linear approximation (top right), and actual nonlinear function (bottom right).

The aim of this thesis is to develop methods for analysis and design of polyhedral piecewise linear control systems. The above examples serve as simple prototype systems that illustrate the system class and indicate some systems that can be dealt with using this approach.

Model Definition

A polyhedral piecewise linear system consists of a subdivision of the state space into polyhedra, and the specification of the dynamics valid within each region. In this way, a piecewise linear system may be described as a collection of ordered pairs,

$$\{(\Sigma_i, X_i)\}_{i \in I} \quad (2.2)$$

that to each polyhedral region X_i associates a linear dynamics Σ_i . The index set of the sets is denoted I . We will write the system dynamics as

$$\Sigma_i : \begin{cases} \dot{x}(t) = A_i x(t) + a_i + B_i u(t) \\ y(t) = C_i x(t) + c_i + D_i u(t) \end{cases} \quad \text{for } x(t) \in X_i. \quad (2.3)$$

Here, $x \in \mathbb{R}^n$ is the continuous state vector, $u \in \mathbb{R}^m$ is the input vector and $y \in \mathbb{R}^p$ is the output vector. The notion $\dot{x} = dx/dt$ denotes the time derivative of x . The matrices $A_i, a_i, B_i, C_i, c_i, D_i$ are fixed in time, and of compatible dimensions.

The sets $X_i \subseteq \mathbb{R}^n$ are assumed to be closed, possibly unbounded, convex polyhedra. In other words, the X_i are convex sets resulting from the intersection of a finite number of closed halfspaces. This implies that for each X_i , there exists a matrix G_i and a vector g_i so that

$$X_i = \{x \mid G_i x + g_i \geq 0\}. \quad (2.4)$$

Here, the vector inequality $z \succeq 0$ means that every element of the vector z should be non-negative. The *partition*, $X = \{X_i\}_{i \in I}$ covers a subset of the state space, $X \subseteq \mathbb{R}^n$. We will assume that the cells have disjoint interior, so that any two cells may only share their common boundary.

Many results in this thesis are concerned with the analysis of equilibria. We will assume that the interesting equilibrium point is located at $x = 0$. It is then convenient to let $I_0 \subseteq I$ be the set of indices for cells that contain the origin, and $I_1 \subseteq I$ be the set of indices for cells that do not contain the origin. It is assumed that $a_i = c_i = 0$ for $i \in I_0$.

In order to evaluate the right hand side of (2.3) for a given $x = x_0$, we simply have to find i such that the vector inequality $G_i x_0 + g_i \succeq 0$ holds. Thus, G_i and g_i work as *cell identifiers* for cell X_i . If x_0 lies in the interior of a cell, this i is unique, and we can recall the appropriate system matrices to evaluate the model (2.3). If x_0 lies on a cell boundary, there are several i that satisfies the vector inequality and the right-hand side may not be uniquely defined. This is the case for non-smooth systems, and we will return to this later. We demonstrate the notation on the piecewise linear system in Example 2.1.

EXAMPLE 2.3—CELL IDENTIFIERS FOR SATURATED SYSTEM

Consider the linear system with actuator saturation used in Example 2.1. The cell identifiers are given by

$$\begin{aligned} G_1 &= [-k^T], & g_1 &= [-1], \\ G_2 &= \begin{bmatrix} k^T \\ -k^T \end{bmatrix}, & g_2 &= \begin{bmatrix} 1 \\ 1 \end{bmatrix}, \\ G_3 &= [k^T], & g_3 &= [-1]. \end{aligned}$$

We have the index sets $I_0 = \{2\}$ and $I_1 = \{1, 3\}$. From (2.1) we can verify that $a_i = c_i = 0$ for $i \in I_0$. \square

A Notational Simplification and a Matrix Parameterization

For convenient treatment of affine terms, we define

$$\bar{x}(t) = \begin{bmatrix} x(t) \\ 1 \end{bmatrix}.$$

The vector \bar{x} can be thought of as an augmented state vector, where the last component is constant. Throughout this thesis, a bar over a vector denotes the augmentation of the vector with the unit element 1, Somewhat informally, a bar over a matrix indicates that it has been modified to be

compatible with the augmented signal vector, *i.e.*

$$\dot{\bar{x}} = \begin{bmatrix} \dot{x} \\ 0 \end{bmatrix} = \begin{bmatrix} A_i & a_i \\ 0_{1 \times n} & 0 \end{bmatrix} \bar{x} := \bar{A}_i \bar{x}$$

This allows us to introduce the compact notation

$$\bar{S}_i = \left[\begin{array}{c|c} \bar{A}_i & \bar{B}_i \\ \hline \bar{C}_i & \bar{D}_i \end{array} \right] = \left[\begin{array}{cc|c} A_i & a_i & B_i \\ 0_{1 \times n} & 0 & 0_{1 \times m} \\ \hline C_i & c_i & D_i \end{array} \right] \quad (2.5)$$

$$\bar{G}_i = [G_i \quad g_i]. \quad (2.6)$$

The matrices \bar{S}_i will be called *system matrices*, and \bar{G}_i will be called *cell identifiers*. With this notation, the dynamics (2.3) can be re-written as

$$\begin{bmatrix} \dot{\bar{x}}(t) \\ y(t) \end{bmatrix} = \bar{S}_i \begin{bmatrix} \bar{x}(t) \\ u(t) \end{bmatrix} \quad \text{for } \{x \mid \bar{G}_i \bar{x} \succeq 0\} \quad (2.7)$$

which allows the system (2.2) to be represented by a set of matrix pairs,

$$\{(\bar{S}_i, \bar{G}_i)\}_{i \in I}.$$

specifying the local dynamics and state space partitioning respectively.

2.2 Solution Concepts

A dynamic model can not be fully understood without specifying what we mean by a solution to the system equations. One way of defining a solution is to specify how to generate the future behavior $x(t)$ of the system from any initial state $x(0) = x_0$. This is closely related to providing a simulation algorithm for the system. This approach is intuitive and favored by many engineers. For some models, however, it may be impossible to find a meaningful solution concept that gives unique solutions. It is then more natural to define a solution as any behavior which is compatible with the model. In other words, a function $x(t)$ is a solution to a model if it has a time derivative and satisfies the model equation everywhere on a given time interval. This is the classical solution concept for ordinary differential equations, and a system model may in this case admit a whole family of solutions for a given initial value.

The right-hand side of the equation (2.3) may in general be discontinuous at cell boundaries. As we will see later, this makes it hard to devise

simulation algorithms that give unique solutions, and the alternative approach is more appropriate. Initially, we will restrict our attention to the case when the non-smooth dynamics does not create any problems for our analysis. The following definition of a trajectory will allow us to discuss admissible behaviors of the model (2.3)

DEFINITION 2.1—TRAJECTORY

Let $x(t) \in \cup_{i \in I} X_i$ be an absolutely continuous function. We say that $x(t)$ is a *trajectory* of the system (2.3) on $[t_0, t_f]$ if, for almost all $t \in [t_0, t_f]$, the equation $\dot{x}(t) = A_i x(t) + a_i + B_i u(t)$ holds for all i with $x(t) \in X_i$. \square

For our class of piecewise linear systems, the equation (2.3) defines unique C^1 trajectories in the interior of the cells. If such a trajectory at time t_k passes through a cell boundary where the vector fields in the neighboring regions do not match, the time derivative $\dot{x}(t_k)$ is not defined. However, if $x(t)$ does not remain on the cell boundary for any time interval, these time instants can be removed without disqualifying $x(t)$ from being a trajectory, see Figure 2.3. Trajectories are allowed to remain on cell boundaries only if the vector fields defined in the interior of the neighboring cells match.

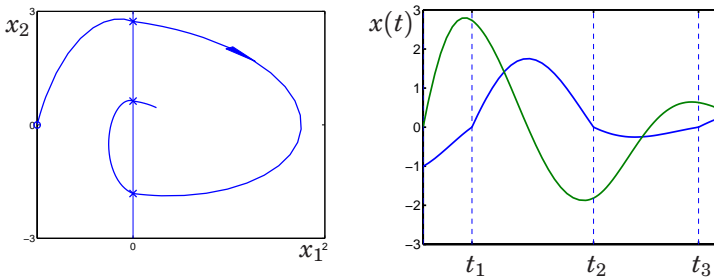

Figure 2.3 Phase plane plot and time plots of a trajectory of a piecewise linear system. The times t_k , marked with dashed lines in the time plot, are the times where $x(t) \in X_1 \cap X_2$, and the time derivative of (2.3) is not defined. As $x(t)$ does not stay on the boundary for any time interval, it still qualifies as a trajectory.

The main obstacle in the analysis of non-smooth systems will be the cases when no continuation of a trajectory in the sense of Definition 2.1 is possible. In these cases, it may still be possible to define meaningful solution concepts that considers $x(t)$ that remain on the cell boundaries for some time interval, see [39, 138]. Such a behavior is often called a sliding mode. We will comment upon sliding modes on several occasions in this thesis. For sake of clarity, however, we prefer to present the main ideas for systems that do not have sliding modes. The following definition allow us to single out such situations.

DEFINITION 2.2—ATTRACTIVE SLIDING MODE

Given $u \equiv 0$, the system (2.3) is said to have an *attractive sliding mode* at x_S if there exists a system trajectory with final state x_S , but no trajectory with initial state x_S . \square

Methods for detection of attractive sliding modes in piecewise linear systems will be given in Section 3.4. Analysis conditions will initially be derived for systems without attractive sliding modes. The necessary extensions for systems with sliding modes will be given in Section 4.11.

2.3 Uncertainty Models

Uncertainty and robustness are central themes in modeling and analysis of feedback systems. One of the most important reasons for using feedback is to guarantee that system specifications are met despite variations in system components and exogenous disturbances. Furthermore, since there is always a mismatch between the models that are used for control design and the actual system, it is important to account for this uncertainty so as to ensure that the results derived from the model also hold in reality.

To verify robustness we have to somehow specify the sets of admissible uncertainties and disturbances. In this section, we will extend the standard uncertainty models for linear uncertain systems to systems that are piecewise linear. This will allow us to use analysis results for piecewise linear systems for rigorous analysis of smooth nonlinear systems. We will consider two main classes of uncertainties. The first class is systems

$$\dot{x} = f(x)$$

where the function $f(x)$ is uncertain. This situation may occur when $f(x)$ is a piecewise linear approximation of some smooth function. If the uncertainty is due to unknown or time-varying parameters, this is usually called *parametric uncertainty*. The second class of uncertainty descriptions deals with systems on the form

$$\begin{aligned}\dot{x} &= f(x, y) \\ \dot{y} &= g(x, y)\end{aligned}$$

where $g(x, y)$ is uncertain or lacks a description with appropriate structure. This type of uncertainty is usually called *dynamic uncertainty*, and may occur when y represents an exogenous disturbance or a neglected component.

Piecewise Linear Differential Inclusions

One way to embed more general nonlinear systems in the piecewise linear framework is to allow systems with time-varying system matrices

$$\begin{cases} \dot{x}(t) = A_i(t)x(t) + a_i(t) + B_i(t)u(t) \\ y(t) = C_i(t)x(t) + c_i(t) + D_i(t)u(t) \end{cases} \quad \text{for } x \in X_i$$

We will consider the case when the system matrices \bar{S}_i for each cell can be written as a convex combination of matrices $\bar{S}_i^1, \dots, \bar{S}_i^k$. In other words, we assume that for every t there exist scalars $\alpha_k(t) \geq 0$ with $\sum_k \alpha_k(t) = 1$ such that $\bar{S}_i(t)$ can be written as

$$\bar{S}_i(t) = \sum_k \alpha_k(t) \bar{S}_i^k. \quad (2.8)$$

We will then consider the family of models obtained by considering all admissible $\alpha_k(t)$. For notational convenience, we will to each cell X_i associate an index set $K(i)$ that specifies the matrices that are used in the inclusion. We will then write (2.8) as

$$\bar{S}_i(t) \in \overline{\text{co}}_{k \in K(i)} \{ \bar{S}_k \}. \quad (2.9)$$

Here, $\overline{\text{co}}$ stands for convex closure. We will call these models *piecewise linear differential inclusions, pwLDIs*. An absolutely continuous function $x(t)$ is called a solution of the inclusion on $[t_0, t_f]$ if, for almost all $t \in [t_0, t_f]$ it satisfies

$$\begin{bmatrix} \dot{x}(t) \\ y(t) \end{bmatrix} \in \overline{\text{co}}_{k \in K(i)} \left\{ \bar{S}_k \begin{bmatrix} x(t) \\ u(t) \end{bmatrix} \right\} \quad \text{for } x(t) \in X_i \quad (2.10)$$

Linear differential inclusions have been used to model parametric uncertainty in linear systems. An important special case is the sector conditions that have been used in the work on absolute stability [88, 152, 114]. In this context, the extension to piecewise linear differential inclusions allows us to use *piecewise linear sector bounds* to embed smooth nonlinear systems into the piecewise linear framework.

EXAMPLE 2.4—SECTOR BOUNDED NONLINEARITY

Consider an integrator in a negative feedback loop with static nonlinearity

$$\begin{cases} \dot{x}(t) = -\phi(x(t)) \\ y(t) = x(t) \end{cases}$$

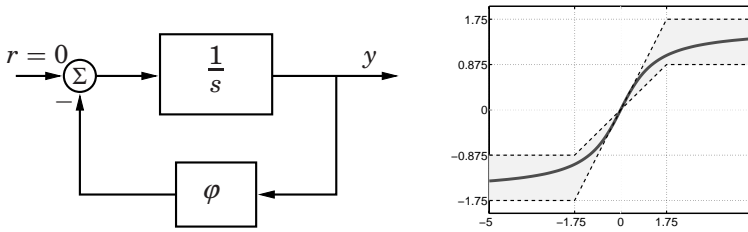

Figure 2.4 Analysis of smooth nonlinear system (left) via piecewise linear sector bounds on the nonlinearity (right).

Assume that the nonlinearity $\phi(x(t))$ can be bounded by “piecewise linear sectors”, see Figure 2.4. This implies that there exists vectors \bar{l}_i and \bar{u}_i describing upper and lower bounds respectively, such that

$$\phi(x(t)) \in \overline{\text{co}}(\bar{l}_i^T \bar{x}(t), \bar{u}_i^T \bar{x}(t)) \quad \text{for } x \in X_i.$$

The closed loop system can then be described by the piecewise linear differential inclusion

$$\bar{S}_i(t) \in \overline{\text{co}}(\bar{S}_i^+, \bar{S}_i^-)$$

with

$$\bar{S}_i^+ = \left[\begin{array}{c|c} -\bar{l}_i & 1 \\ \mathbf{0} & 0 \\ \hline 1 & 0 \end{array} \right], \quad \bar{S}_i^- = \left[\begin{array}{c|c} -\bar{u}_i & 1 \\ \mathbf{0} & 0 \\ \hline 1 & 0 \end{array} \right].$$

Notice that the integrator system could be replaced with a general piecewise linear system, and all results would follow similarly. \square

The piecewise linear sector bounds will be used to derive computational analysis methods for smooth nonlinear systems and fuzzy systems in Chapter 7. The problem of finding piecewise upper and lower bounds on smooth nonlinear functions has also attracted interest in the approximation community, see [85].

Norm-Bounded Approximation Errors

One problem with uncertainty descriptions in terms of differential inclusions is that the analysis conditions must consider every extreme dynamics in each region. A careless application of pwLDIs in the modeling phase can then generate a large number of extreme systems, which may render the analysis computations intractable.

If the piecewise linear system is obtained by approximating a smooth system, it is natural to use a norm bound on the error

$$\|f(x) - A_i x - a_i\| \leq \varepsilon_i \|x\| \quad \text{for } x \in X_i, i \in I.$$

between the right-hand side of $\dot{x} = f(x)$ and its piecewise linear approximation. Now, rather than specifying a set of extreme dynamics for each cell, we only have to provide one norm bound ε_i for each cell. Moreover, if $f(x)$ is smooth, the bounds on the approximation error will decrease as the partition is refined. This observation is useful in theoretical studies of algorithms that use piecewise linear system descriptions to analyze smooth nonlinear systems. We will return to this issue in Chapter 7.

Dynamic Uncertainties and Dissipation Inequalities

The standard approach to account for dynamic uncertainties is to consider norm-bounded uncertainties in a feedback interconnection as shown in Figure 2.5. In robust control literature, the nominal system Σ is assumed

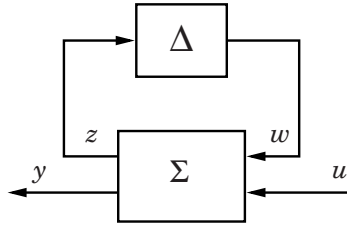

Figure 2.5 Piecewise linear system with uncertainty feedback.

to be linear time invariant, while system nonlinearities and uncertainties are confined to the uncertainty block Δ . In contrast to this, we will allow Σ to be piecewise linear. In this way, we can choose whether system nonlinearities should be expressed in the piecewise linear subsystem or as uncertainties in the Δ subsystem. This additional freedom can be used to trade off computational complexity against conservatism in the analysis.

The operator Δ that specify the feedback $u = \Delta y$ may be linear time varying or nonlinear, but is assumed to satisfy the dissipation inequality

$$\int_0^t \begin{bmatrix} y(s) \\ u(s) \end{bmatrix}^T M \begin{bmatrix} y(s) \\ u(s) \end{bmatrix} ds \geq 0 \quad \text{for all } t \geq 0 \quad (2.11)$$

for some real symmetric matrix M . Passivity and bounded \mathcal{L}_2 -induced gains can for example be expressed in this way. After establishing gain and passivity properties of the components, we may try to use small gain or passivity results to establish stability of the closed loop system [78].

A Modeling Trade-off: Uncertainty versus Complexity

There is an intrinsic tradeoff between fidelity and complexity of a model. Limited physical knowledge and limited modeling resources enforce us to settle with simple models that capture the “most important” system characteristics. Such models are often easier to understand and use in the design process.

The piecewise linear sector bounds allows stepwise refinements of a global sector bounds to improve a nonlinearity description. In the end, such refinements allow arbitrarily tight inclusions of any continuous function. However, each such refinement comes at the price of increased memory requirements for the model representation and increased computational cost for the analysis. It is thus natural to look for the simplest model that gives a sufficiently accurate answer in the analysis. The following example illustrates the ideas.

EXAMPLE 2.5—PIECEWISE LINEAR MODELING AND COMPLEXITY

In Chapter 5 we will encounter a system on the form

$$\frac{d}{dt}x(t) = Ax(t) - B\varphi(Cx(t))$$

where the nonlinearity $\varphi(\cdot)$ is a spring with the piecewise linear characteristic shown in Figure 2.6 (left). Using the exact description requires many segments and results in relatively demanding analysis computations. It is therefore attractive to base the analysis on an approximate model that requires less computations. The piecewise linear sector bounds give many possibilities. For the specific example in Chapter 5, the piecewise linear sector bounds (middle) can be used to assess stability while an analysis based on global sector bounds (right) fails. \square

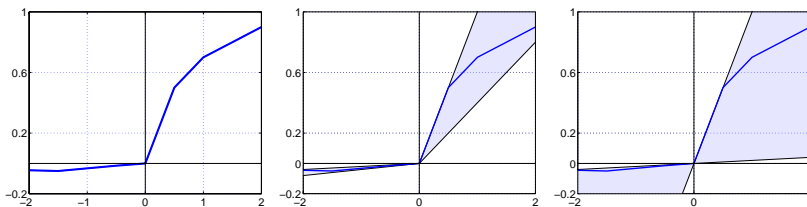

Figure 2.6 From exact description to global sector bounds. Piecewise linear sector bounds allow us to trade precision of the model against simplicity of the computations.

Although the principle of refinements using piecewise linear sector bounds has been illustrated on a scalar nonlinearity, the methods applies also to multi-variable nonlinearities.

Note that pointwise function approximation measures are only very loosely related to the question about what is a “good” description of a nonlinearity for system analysis. Although global sector bounds can be arbitrarily bad in function approximation measures, they are often sufficiently accurate to assess stability of systems. The possibility of arbitrarily good approximations, however, is useful in establishing asymptotic results that computations will always give an affirmative answer for a “sufficiently refined” partition (see [120]).

2.4 Modularity and Interconnections

Modularity and structure-preserving interconnections are attractive features in modeling and analysis of dynamic systems. Modularity allows complex systems to be represented as the interconnection of simpler subsystems. Important model components can be stored in a library and recalled and interconnected as needed. Structure-preserving interconnections are also very useful, since they grant that the interconnected system shares important structural properties with its components. For example, series, parallel and feedback interconnections of linear systems are themselves linear systems. This allows the full systems and its components to be analyzed using the same tools. We can then choose whether to analyze the complex system directly, or to analyze its subcomponents and invoke interconnection results such as small gain and passivity theorems.

The following proposition states that the most common interconnection structures preserves the piecewise linearity of its components. Its proof also shows how a system representation for a complex system can be derived from the representations of its piecewise linear subsystems and their interconnection structure.

PROPOSITION 2.1—STRUCTURE-PRESERVING INTERCONNECTIONS

Series, parallel and feedback interconnections without algebraic loops of polyhedral piecewise linear systems are themselves polyhedral piecewise linear systems. Moreover, a matrix representation $\{\tilde{S}_i, \tilde{G}_i\}_{i \in I}$ for the total system is obtained directly from the matrix representations of its components. \square

Proof: The result follows by direct computations, see Section A.1. The proof also gives the matrix representation of the interconnected system.

The proof of Proposition 2.1 reveals that the interconnection of two piecewise linear systems results in a combinatorial growth in the number of cells. Consider the interconnection of the system Σ_1 with state vector x and partition $\{X_i\}_{i \in I}$ and the system Σ_2 with state vector z and partition $\{Z_j\}_{j \in J}$. The partition of the interconnected system is obtained by considering all combinations of (i, j) such that $x \in X_i$ and $z \in Z_j$. Hence, if Σ_1 has a partition of p_1 cells, and Σ_2 has a partition of p_2 cells, the interconnected system may have $p_1 \times p_2$ cells. This illustrates the usefulness of an input-output analysis for piecewise linear systems. If analysis of the interconnected system gives too costly computations, we can try to analyze the simpler subsystems and apply small gain or passivity arguments.

Proposition 2.1 allows standard piecewise linear components, such as relays and saturations, to be stored in a library and recalled when needed. In these cases, it can be useful to allow partitioning in the product space of the input space and the state space, *i.e.*, to let

$$\tilde{X}_i = \left\{ \begin{bmatrix} x \\ u \end{bmatrix} \mid \tilde{G}_i \begin{bmatrix} \tilde{x} \\ u \end{bmatrix} \succeq 0 \right\}.$$

Although this route will not be pursued here, we note that a similar result to Proposition 2.1 holds also in this case. Modularity has been acknowledged in many other works on piecewise linear systems, see [139, 110]. The following example illustrates the interconnection properties.

EXAMPLE 2.6—INTERCONNECTION PRESERVES STRUCTURE

Consider the series connection of two piecewise linear systems

$$\begin{aligned} \dot{x} &= -\text{sat}(x) + u \\ \dot{y} &= -\text{sign}(y) - x \end{aligned}$$

illustrated in Figure 2.7 (left). The interconnection is itself piecewise linear in accordance with Proposition 2.1. The individual subsystems have two and three cells respectively, the interconnected system has six. Although the combinatorial growth is not so pronounced in this example, it can be significant in more complex systems. \square

Unfortunately, the modular approach does not extend directly to the case when the systems are uncertain in the PwLDI-sense since this may introduce uncertainty in the state space partitioning.

2.5 Comments and References

Piecewise linear systems is an interesting system class, and many important remarks can be made to the developments described so far. Rather

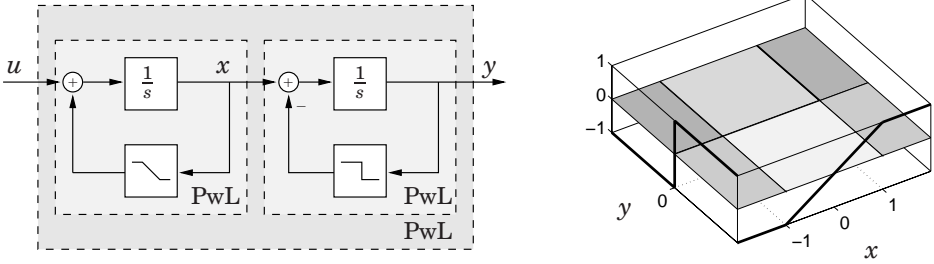

Figure 2.7 Series connection of two piecewise linear systems is piecewise linear (left). The interconnected system has the partition shown to the right.

than obstructing the general presentation with long discussions, we have chosen to collect such remarks in a special section. Some of the material presented here are pure remarks, while others discuss related work, give alternative perspectives on the material or present issues that are not otherwise covered in the thesis.

Piecewise Linear or Piecewise Affine?

The term piecewise linear may at first appear inappropriate for the system (2.3), since the dynamics is in fact affine in the state. However, since the name is generally accepted, we have chosen not to make a stronger point out of this. One may motivate the name piecewise linear by the fact that around any trajectory inside a cell, the dynamics will behave linearly.

Memory Efficient Representations

Modeling and simulation of piecewise linear systems has attracted a large interest in the circuit theory community during the last decades [30, 84]. Driven by the need to simulate large-scale circuits with piecewise linear components, a large research effort has been focused on deriving memory efficient representations for piecewise linear systems. More compact descriptions than the matrix representation (2.7) can be obtained when the vector field of the system is continuous across cell boundaries. To see this, consider the situation in Figure 2.8.

To obtain continuity on the hyperplane $\mathcal{H}_{ij} = \{x \mid h_{ij}^T x + g_{ij} = 0\}$, the system matrices must satisfy

$$\begin{aligned} A_j &= A_i + c_{ij} h_{ij}^T \\ \alpha_j &= \alpha_i + c_{ij} g_{ij} \end{aligned}$$

for some $c_{ij} \in \mathbb{R}^n$. Since the boundary equations of the cells reappear in the description of feasible changes in the mapping, there is a certain

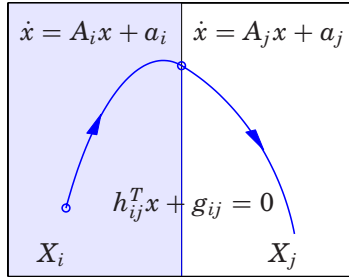

Figure 2.8 Continuity of vector fields allows parameter savings.

redundancy in the data given by the simple model (2.7). The argument above indicates that it should be sufficient to store one linear system description, the boundary equations, and the update vectors c_{ij} .

The first compact parameterization that appeared was the *canonical piecewise linear function description* introduced in [30]. For piecewise linear dynamic systems, it takes the form

$$\dot{x} = Ax + a + \sum_{i=1}^p c_i |g_i^T x + h_i|. \quad (2.12)$$

This representation stores only a single affine system description, the boundary hyperplane equations, and the update vectors. It has also eliminated the need for explicit storage of cell descriptions, and no cell identification is necessary to evaluate the mapping. The representation (2.12) is very efficient compared to the simple matrix parameterization (2.7). However, it can only represent a subset of the continuous piecewise linear mappings (cf. [71, 77]). To overcome this problems, various higher order basis function expressions have been suggested. These are much more complicated than the simple model (2.12), but can be put in the general form

$$\dot{x} = Ax + a + \sum_{i=1}^q c_i \varphi_i(x)$$

Here, the $\varphi_i(x)$ are piecewise linear functions constructed from nested absolute or maximum functions, see [71, 43, 77]

An alternative formulation, which is closely related to the matrix representation (2.7), is the *implicit piecewise linear function description* re-

ported in [139]

$$\begin{cases} \dot{x} = Ax + a + Bu \\ i = Gx + g + Cu \\ 0 = u^T i \quad u \succeq 0, i \succeq 0 \end{cases} \quad (2.13)$$

This representation was derived from a static linear network where some ports have been terminated by negative ideal diodes [77]. The variables i and u correspond to currents and voltages respectively, and the last equation of (2.13) describes the characteristic of an ideal negative diode. Vectors u and i that satisfy this equation are called *complementary*. To see the close connection to our matrix parameterization, consider the region where $u = 0$. Then, the above model reduces to

$$\dot{x} = Ax + a \quad \text{for } x \text{ such that } Gx + g \succeq 0.$$

Given a vector x , an evaluation of the mapping needs the associated diode voltages u . This requires that we solve the linear complementary problem of finding i and u that satisfy the last two equations of (2.13). In principle, a solution to this problem can be obtained through a sequence of pivoting operations around the C -matrix. Each such pivoting step forces one entry of the vectors u or i to zero, while the corresponding entry in the other vector is allowed to be non-zero. The non-zero entries of u and i define affine inequalities in x (since the corresponding entries of the other vector are zero), and hence closed halfspaces in the state space. The zero entries in the i -vector forces the corresponding entries of u to be affine functions of x . These affine expressions are used to describe the relative changes in the local dynamics via the first equation of (2.13). In this way, the matrix C encodes the changes in the cell descriptions, while the matrix B encodes the changes in the affine dynamics. The best way to understand the implicit model (2.13) in further detail is to work through some of the examples given in [139] (see also [28, 110]).

One drawback with the implicit model (2.13) is that a solution to the linear complementary problem may require a number of pivoting operations that is exponential in the number of entries of the vectors u and i . As we have seen above, solving the linear complementary problem is related to performing a cell identification in our framework. The exponential complexity is related to the fact that we may have to check membership to all cells when evaluating the piecewise linear mapping. However, once a feasible set of complementary vectors u and i has been found, only one pivoting operation is needed in order to determine the new set-up when one constraint has been violated. This has allowed the development of fast

and memory efficient simulation programs based on this model [28]. We also note that complementary conditions occur naturally in the modeling of impulse and contact forces in mechanics, see [87, 141].

3

Structural Analysis

The main aim of this thesis is to provide quantitative methods for analysis of piecewise linear dynamical systems. This chapter will present the first building blocks of such an analysis. The methods described here are mainly of a static nature, and can all be obtained through vector field considerations. We will treat equilibrium computations and static gain analysis, as well as detection of sliding modes and verification of affine state constraints. These results are useful for ruling out degeneracies in piecewise linear models, give important engineering insight and are valuable complements to the Lyapunov-based methods developed in the subsequent chapters.

3.1 Equilibrium Points and Static Gain Analysis

An initial problem in the study of a nonlinear system is to determine its equilibrium points. In this context, we will understand the term *equilibrium point* as a constant trajectory (in the sense of Definition 2.1). Contrary to a linear system which always has an equilibrium at the origin, a general nonlinear system

$$\begin{aligned}\dot{x} &= f(x, u) \\ y &= g(x, u)\end{aligned}$$

may have any number of equilibrium points. We will make a distinction between *equilibrium point computations* and *static gain analysis*. In equilibrium point computations, we let $u = 0$ and consider the problem of finding the solutions x^* to the equation $f(x^*, 0) = 0$. By static gain analysis, we refer to the problem of computing the outputs y^* that correspond to the equilibrium points obtained for a constant input signal $u = u^*$. This problem can be solved by first computing the equilibrium point $x = x^*$ for

the system corresponding to $u = u^*$, and then obtaining the corresponding output from the map $y^* = g(x^*, u^*)$. These computations may be more or less straightforward depending on the structure of the function $f(x, u)$.

Equilibrium Point Computations

For piecewise linear systems on the form (2.3), it is a simple matter to compute the equilibrium points that lie in the interior of cells. It suffices to check if each affine system has equilibrium points within its own operating regime. These computations are conveniently formulated as linear programming problems, and all equilibrium points of the system can be found with ease.

PROPOSITION 3.1—EQUILIBRIUM POINT COMPUTATIONS

The piecewise linear system (2.3) has an equilibrium point in the interior of cell X_i if and only if the linear programming problem

$$\begin{cases} \bar{A}_i \bar{x} = 0 \\ \bar{G}_i \bar{x} \succ 0 \end{cases}$$

has a feasible solution. □

The formulation of the above proposition does not treat equilibrium points on the boundary of cells. If one desires to consider equilibrium points also on cell boundaries, one can simply replace the strict vector inequality $\bar{G}_i \bar{x} \succ 0$ by its non-strict counterpart $\bar{G}_i \bar{x} \succeq 0$. In order for the computed x to be an equilibrium point, it must then satisfy

$$\bar{G}_i \bar{x} \succeq 0 \quad \text{for all } i \text{ with } x \in X_i.$$

Note that our discussion of equilibrium points depends on our trajectory definition, and that stationary points in attractive sliding modes are not considered in this definition.

The above approach is somewhat “brute-force” as all cells have to be considered, one-by-one. If the system has continuous vector fields, it is possible to exploit the continuity and arrive at more efficient algorithms for equilibrium point computations, see *e.g.* [32, 144, 105]. The following example demonstrates the analysis.

EXAMPLE 3.1—A BISTABLE ELECTRICAL CIRCUIT

Consider the tunnel diode circuit in Figure 3.1. The circuit equations are given by

$$\begin{cases} C \frac{d}{dt} v_c = i_L - g_R(v_c) \\ L \frac{d}{dt} i_L = u - R i_L - v_c \end{cases}$$

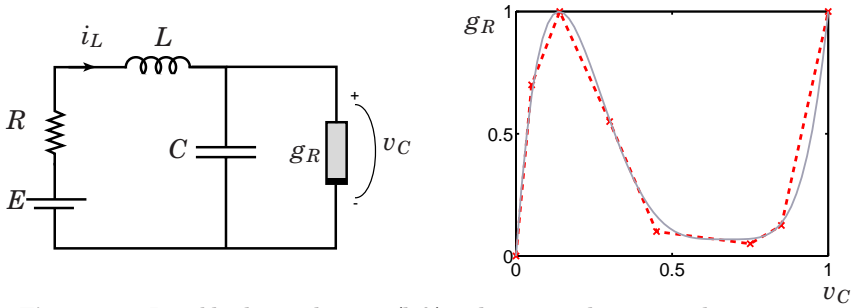

Figure 3.1 Bistable electrical circuit (left) and piecewise linear $i-v$ characteristic (right).

where $g_R(v_c)$ denotes the conductance of the nonlinear element. We use the parameters taken from [78, 31], $R = 1.5\text{k}\Omega$, $C = 2\text{pF}$, $L = 5\mu\text{H}$. By measuring time in nanoseconds and currents in mA, we obtain

$$\begin{cases} \frac{d}{dt}v_c = 0.5[-g_R(v_c) + i_L] \\ \frac{d}{dt}i_L = 0.2[-v_c - Ri_L + u] \end{cases}$$

Using a seven-segment piecewise linear approximation of $g_R(v_c)$ based on the data given in [78], we obtain a piecewise linear approximation of the system. Letting $u = 1.2$, we run the computations of Proposition 3.1 to find the three equilibrium points

$$x_1^* = \begin{bmatrix} 0.07 \\ 0.76 \end{bmatrix}, \quad x_2^* = \begin{bmatrix} 0.28 \\ 0.62 \end{bmatrix}, \quad x_3^* = \begin{bmatrix} 0.87 \\ 0.22 \end{bmatrix}.$$

which have good correspondence with the computations in [78]. \square

The formulation of Proposition 3.1 may appear unnecessarily complicated. A more straightforward solution would be to solve the equation

$$A_i x^* + a_i = 0 \tag{3.1}$$

and then simply test whether $\bar{G}_i \bar{x}^* > 0$. The only problem one may have is when the matrix A_i is not invertible, which corresponds to the case when the local dynamics has an equilibrium set. The solution set of (3.1) may in this case have points both within X_i and outside of X_i . By picking an arbitrary solution to (3.1) and subsequently performing a cell identification may then fail to find an equilibrium point within the operating regime. In

contrast, the computations in Proposition 3.1 will always admit a solution if the equilibrium set intersects the operating regime.

The value of an equilibrium point computation is significantly increased if it is combined with a local analysis of the properties of the equilibria. Such an analysis can be obtained by eigenvalue inspection. We have already mentioned how a local analysis may reveal that the system has an equilibrium set rather than isolated equilibrium points. More importantly, if the system has no sliding modes and no stable equilibrium points then the state vector either tends to infinity, or towards some non-stationary behavior (possibly a limit cycle). If there are no locally stable equilibrium points it is fruitless to try to assess global stability.

Static Gain Analysis

The equilibrium computation is a key component in a procedure for static gain analysis. The static gain analysis consists of determining the possible steady-state values of the system output for an arbitrary but constant input signal. For the piecewise linear system

$$\begin{cases} \dot{x} = \bar{A}_i \bar{x} + \bar{B}_i u \\ y = \bar{C}_i \bar{x} + \bar{D}_i u \end{cases} \quad \text{for } x \in X_i$$

we fix $u = u^*$ and invoke Proposition 3.1 to find the equilibrium points of the corresponding piecewise linear system

$$\dot{x} = A_i x + \underbrace{a_i + B_i u^*}_{a_i^*} := A_i x + a_i^* \quad \text{for } x \in X_i.$$

If the solution $x = x^*$ lies in X_i , the corresponding output is obtained as

$$y = C_i x^* + c_i + D_i u^*.$$

By repeating the computations for a range of inputs u^* one obtains a steady-state characteristic. Combining the computations with a local stability analysis, it is possible to determine if the steady state values are locally stable. In order to assess global convergence to the steady-state characteristic, it is necessary to do a global stability analysis for each constant input signal. Tools for such analysis will be developed later in this thesis. We give the following example.

EXAMPLE 3.2—STATIC GAIN ANALYSIS OF THE BISTABLE CIRCUIT

As shown in Example 3.1, the bistable electrical circuit can exhibit multiple equilibrium points for some values of the input voltage u . Indeed, the

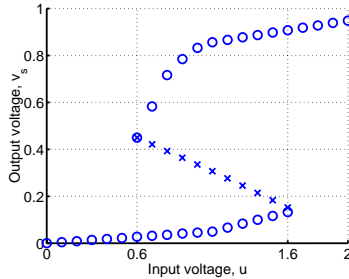

Figure 3.2 Static characteristic showing multiple equilibria for $0.6V \leq u \leq 1.6V$. Local stability of the equilibria is marked by \circ , instability marked by \times .

circuit has been used as a computer memory, since a small shift in the input voltage can make shift the system state from one equilibrium to the other. By considering the capacitor voltage v_c as an output and performing the static analysis above with $u \in [0, 2]$, we obtain the characteristic shown in Figure 3.2. We see that for $0.6V \leq u \leq 1.6V$ the system possesses three equilibrium points, while it has unique equilibria for other inputs. One equilibrium point is locally unstable (marked \times) while the others are locally stable (marked \circ).

□

State Transformations

When analyzing the global properties of an equilibrium point, it is often convenient to make a state transformation so that this point is the origin in the transformed coordinates. This transformation is then given by

$$z = x - x^* = [I \quad -x^*] \bar{x} := \mathcal{T}\bar{x}.$$

By applying this state transformation to all system dynamics and all cell identifiers, one obtains a piecewise linear system with an equilibrium point in the origin.

3.2 Detection of Instabilities

Equilibrium computations and subsequent analysis of the local dynamics reveal the presence of unstable equilibrium points. However, a local instability does not imply that the state vector tends to infinity, since the system may have several equilibrium points (some of which are stable) or limit cycles. However, in some cases it is simple to detect that

the state vector tends to infinity. One such situation is when we can find an eigenvector (corresponding to an unstable real eigenvalue) of some A_i along which the state can pass to infinity without leaving the cell X_i , see Figure 3.3. This can be done by the following proposition.

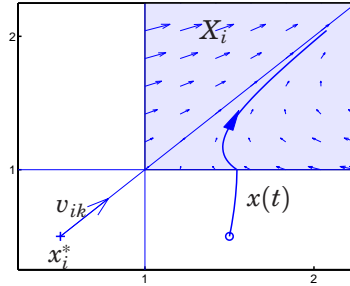

Figure 3.3 Detection of a global instability. The state passes to infinity along the unstable eigenvector v_{ik} of A_i without leaving the cell X_i .

PROPOSITION 3.2

Consider the polyhedral piecewise linear system

$$\dot{x} = A_i(x - x_i^*) = A_i x + a_i \quad \text{for } x \in X_i, i \in I \quad (3.2)$$

with partition $\{X_i\}_{i \in I}$ defined by cell identifiers $\{\bar{G}_i = [G_i \ g_i]\}_{i \in I}$. Let v_{ik} be an eigenvector corresponding to a positive real eigenvalue of A_i , such that $x_i^* + av_{ik} \in X_i$ for some $a \geq 0$. Let $[z]_l$ denote the l th entry of the vector z . If

$$G_i v_{ik} \succeq 0, \quad \text{and } [G_i x_i^* + g_i]_l \geq 0 \text{ when } [G_i v_{ik}]_l = 0$$

then there are trajectories of (3.2) that tend to infinity as $t \rightarrow \infty$. □

Proof: See Section A.2.

3.3 Constraint Verification

Vector field considerations can be used to settle many other analysis questions. One such problem of considerable interest is to verify that certain key variables satisfy magnitude constraints. To this end, we consider

piecewise linear systems on the form (2.3) whose input u satisfies the constraint

$$u^- \leq u(t) \leq u^+ \quad \text{for all } t \geq 0. \quad (3.3)$$

Our aim is to verify if the state vector stays in the constraint set

$$X_C = \{x \mid G_C x + g_C \geq 0\}$$

for all $t \geq 0$ and for any u satisfying the magnitude constraint (3.3). There are several interesting variations of this problem. We will consider the problem of verifying that all trajectories that start in the constraint set remain in this set for all future times. We then say that the constraint set is *positively invariant* with respect to the dynamics (2.3) (see [78]).

For sake of clarity we consider the verification of a single constraint

$$c^T x(t) \leq y^+ \quad \text{for all } t \geq 0. \quad (3.4)$$

This constraint is invariant if and only if we can assure that

$$\dot{y}(t) = c^T \dot{x}(t) \leq 0 \quad \text{for } c^T x = y^+.$$

The geometrical interpretation of this is that the vector field should be inward at the constraint hyperplane $\mathcal{H}_C = \{x \mid c^T x = y^+\}$, see Figure 3.4.

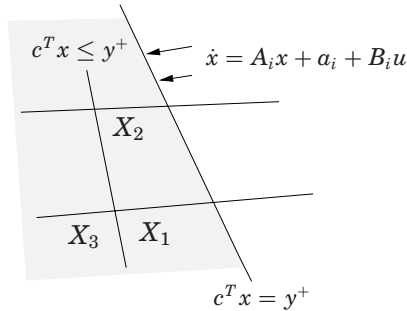

Figure 3.4 Invariance of the constraint $c^T x \leq y^+$ requires that the vector field is inward at the constraint hyperplane.

To single out the cells that intersect the constraint hyperplane, we introduce the index set

$$I_C = \{i \mid X_i \cap \mathcal{H}_C \neq \emptyset\}.$$

We would now like to assure that

$$\dot{y} = c^T(A_i x + a_i + Bu) \leq 0 \quad \text{for } x \in X_i \cap \mathcal{H}_C, \quad i \in I_C. \quad (3.5)$$

and all u that satisfy the magnitude constraint. For simplicity of computations, we will require the inequality (3.5) to be strict. The above verification problem then amounts to establishing that there is no solution x to the inequalities

$$\bar{K}_i(u)\bar{x} := \left[K_i \mid k_i(u) \right] \bar{x} = \left[\begin{array}{c|c} c^T A_i & c^T(a_i + B_i u) \\ c^T & -y^+ \\ -c^T & y^+ \\ G_i & g_i \end{array} \right] \bar{x} \succeq 0 \quad (3.6)$$

when $u \in [u^-, u^+]$. This can be verified using a direct application of Farkas' lemma, see [157]. We give the following result.

PROPOSITION 3.3—CONSTRAINT VERIFICATION

Consider the system (2.3) whose input satisfies the absolute constraint (3.3). If $c^T x(0) \leq y^+$ and there exists vectors $v_i \succeq 0$ and $w_i \succeq 0$ that satisfy

$$\begin{aligned} v_i^T K_i &= 0 & v_i^T k_i(u_-) &> 0 \\ w_i^T K_i &= 0 & w_i^T k_i(u_+) &> 0 \end{aligned}$$

for every $i \in I_C$, then the constraint (3.4) is satisfied for all $t \geq 0$. \square

In order to verify invariance of the full constraint set, we simply apply Proposition 3.3 repeatedly to each constraint. Moreover, if the intersection between the constraint hyperplane and the cell is a convex polytope, it suffices to check that the condition (3.6) is satisfied on the vertices of the polytope.

3.4 Detecting Attractive Sliding Modes

Piecewise linear systems may in general have discontinuous dynamics. This raises delicate issues when defining solutions, making these systems difficult to simulate and analyze, see [92, 91].

In the model (2.3), the cells share their common boundaries. If the right hand side of (2.3) is discontinuous in x , the model can only be used to generate unique trajectories in the interior of the cells. The trajectory

concept given in Definition 2.1 works also in the discontinuous case, as long as the state does not remain on a cell boundary for some time interval, but always “passes through”. The definition of attractive sliding mode accounts for the cases where such a continuation is not possible, but any solution must remain on boundary for some time interval. This is the case when the vector fields in all neighboring cells point towards their common boundary. Physically, such a situation would typically mean that the state would undergo a number of very fast mode changes, moving from one cell to its neighbor and back. We will discuss this behavior more in Section 4.11.

In many cases, sliding modes are unwanted phenomena that occur either due to modeling abnormalities or due to careless design of switching controllers. An important exception is the design of sliding mode controllers, see [130, 138], where sliding modes are used to design simple and robust controllers. In any case, it is very useful to be able to detect unintentional sliding modes at an early development stage. In many cases, unintended sliding modes are detected first when a control system is tested in simulations. Since the dynamics on the switching boundaries is not automatically well defined, most simulators simply gets stuck when entering a sliding mode.

Detection of Sliding Modes on Cell Faces

Sliding modes may occur at cell faces (the boundaries between two cells), or on intersection of multiple boundaries. Whereas sliding modes on single hypersurfaces are well studied, see [39, 138], the case of sliding modes on intersecting hypersurfaces is much more involved [91, 125]. Here, we will only consider the problem of detecting sliding modes on cell faces. In this case, we only need to check if there is a non-empty set on the cell boundary where the vector fields from the neighboring cells point inwards. Such a set will be called a *sliding set*.

Consider the system (2.3), and let $X_i \subset \mathbb{R}^n$ and $X_j \subset \mathbb{R}^n$ be two cells with a common $n - 1$ dimensional boundary

$$\partial X_{ij} = X_i \cap X_j = \{x \mid g_{ij}^T x + h_{ij} = 0\}$$

where the signs of h_{ij} and g_{ij} be chosen so that

$$\dot{x} = \begin{cases} \bar{A}_i x + a_i & \text{if } g_{ij}^T x + h_{ij} \leq 0 \\ \bar{A}_j x + a_j & \text{if } g_{ij}^T x + h_{ij} \geq 0 \end{cases} \quad (3.7)$$

The situation is illustrated in Figure 3.5. As stated in the following proposition, the sliding set on cell faces ∂X_{ij} can be expressed explicitly and sliding motion will occur if and only if this set is non-empty.

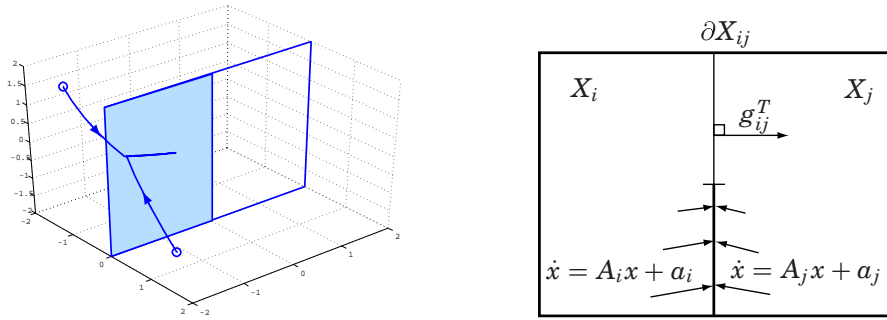

Figure 3.5 Vector fields in neighboring cells point inwards on the sliding set X_S causing a constrained motion along the boundary.

PROPOSITION 3.4—SLIDING MODE DETECTION

Let $\{X_i\}_{i \in I}$ be a polyhedral partition with associated cell identifiers \bar{G}_i . Let the boundary between the cells X_i and X_j be given by

$$\partial X_{ij} = X_i \cap X_j := \{x \mid \bar{g}_{ij}^T \bar{x} = 0\}$$

where $\bar{g}_{ij}^T \bar{x} \geq 0$ for all $x \in X_i$. The sliding set induced by (2.3) on the boundary ∂X_{ij} is the set of x that satisfies

$$\begin{bmatrix} \bar{G}_i \\ \bar{G}_j \\ \bar{g}_{ij}^T \bar{A}_i \\ -\bar{g}_{ij}^T \bar{A}_j \end{bmatrix} \bar{x} \succeq 0.$$

The system (2.3) has an attractive sliding mode on the interior of ∂X_{ij} if and only if this set is non-empty. \square

A similar argument gives conditions for when the vector fields point inwards with respect to several boundary hyperplanes. Such conditions can be used to detect whether there are sets on lower dimensional boundaries (intersections of several $n - 1$ dimensional boundaries) where all neighboring cells generate vector fields that are inward.

3.5 Comments and References

From Signals to Symbols

Vector field considerations are useful for obtaining simplified pictures of the dynamics of piecewise linear systems. By examining the behavior of trajectories on the surfaces of the cells, it is sometimes possible to limit the system behavior to a finite number of alternatives. For example, in some cases one may be able to establish that no trajectory that start inside a cell can exit through a certain cell face. Such an analysis gives a natural aggregation of solutions that makes it possible to abstract away detailed information about solutions in order to obtain a simple picture of the global dynamics. This idea has been used in [110] for the construction of “phase-portraits” for high-dimensional piecewise linear systems. Similar ideas have been used in [55] for verification of piecewise linear hybrid systems. Related is also the concept of cell-to-cell mappings, see [49].

Constraints and Invariance

Invariant sets is a useful notion in the analysis and design of control systems. Their history in control dates back to the early work on Lyapunov stability, see the survey [15]. As any level set of a proper Lyapunov function is invariant, Lyapunov functions can be used to establish invariance of state and control constraints [79, 19]. More recently, invariance have been used in the design of controllers that minimize the peak-to-peak gain (l_∞ -induced gains) see [17, 126] and the references therein. These approaches are often based on the same ideas that were used in Section 3.3. Highly related is also the work [55] that treats invariant set computations for piecewise linear systems using alternative techniques. Note that while [55] considers the construction of invariant sets, we have only treated the simpler problem of verification of a given constraint set.

Controllability and Observability of Piecewise Linear Systems

The treatment of static gain analysis touches upon the concepts of observability and controllability of piecewise linear systems. These issues have not been investigated within this thesis. Controllability of a certain class of piecewise linear systems has been treated in [145, 83].

4

Lyapunov Stability

The main contribution of this thesis is the development of Lyapunov-based analysis methods for piecewise linear systems. The key component of such an analysis, namely methods for Lyapunov function computations, will be presented in this chapter. More precisely, we will show how piecewise quadratic and piecewise linear Lyapunov functions can be computed via convex optimization. The application to system analysis and design of optimal control laws is given in the subsequent chapters. These approaches are substantially more powerful than analysis based on quadratic Lyapunov functions, and the analysis can be carried out using efficient numerical computations.

As always, it is a good idea to use a “simple things first” approach. After determining the equilibrium points of a piecewise linear system it is advisable to verify local stability properties first. If the desired property holds locally, one may invoke the tools developed in this chapter to try to extend the domain of analysis, or even establish global results.

4.1 Exponential Stability

Stability is one of the most fundamental properties of control systems. Intuitively, stability is the property that a system does not explode in some sense. Initially, we will be concerned with asymptotic stability, which in addition assures that the system state tends to rest after an initial transient. More precisely we will be concerned with *exponential stability*, which assures that the convergence of the system state to its equilibrium point can be bounded by an exponential function of time.

There are certainly many asymptotically stable systems whose convergence is not exponential. Still the framework of exponential stability is particularly attractive for Lyapunov analysis of piecewise linear systems. For linear systems, the concepts of asymptotic and exponential stability

coincide, and an equilibrium point of a smooth nonlinear system is locally exponentially stable if and only if its linearization around this point is exponentially stable (cf [78] Theorem 3.13). In other words, the linearization provides necessary and sufficient information to conclude exponential stability of an equilibrium. Moreover, a smooth nonlinear system is (globally) exponentially stable if and only if there exists a Lyapunov function that proves it (cf. [78], Theorem 3.12). This makes exponential stability the appropriate concept in a piecewise linear approach for smooth nonlinear systems. A local analysis around an equilibrium point can be improved step-by-step by splitting the state space into more regions, hereby increasing the flexibility in the nonlinearity description and enlarging the validity domain for the analysis.

The following result, which combines a number of standard results from Lyapunov theory, will be the main tool throughout this chapter.

LEMMA 4.1

Let $x(t) : [0, \infty) \rightarrow \mathbb{R}^n$ and let and let $V(t) : [0, \infty) \rightarrow \mathbb{R}$ be a non-increasing and piecewise C^1 function satisfying

$$\frac{d}{dt}V(t) \leq -\gamma\|x(t)\|^p \tag{4.1}$$

for some $\gamma > 0$ and some $p > 0$, almost everywhere on $[0, \infty)$.

If there exists $\alpha > 0$ such that

$$\alpha\|x(t)\|^p \leq V(t) \leq \beta\|x(t)\|^p \tag{4.2}$$

then $\|x(t)\|$ tends to zero exponentially. If the maximal α that satisfies (4.2) is negative, then $\|x(t)\| \rightarrow \infty$ as $t \rightarrow \infty$. \square

Proof: The following formula for evaluating a piecewise smooth function $W(t)$ will be useful. Let $W(t)$ be a piecewise smooth function, and let t_k denote the points of discontinuity of $W(t)$. Then,

$$W(t^-) = W(0) + \int_0^t \frac{d}{ds}W(s) ds + \sum_{k:t_k < t} \Delta W(t_k) \tag{4.3}$$

where $\Delta W(t_k) = W(t_k^+) - W(t_k^-)$. Obviously, if $W(t)$ is non-increasing, then $\Delta W(t_k) \leq 0$ for all k and we have

$$W(t^-) \leq W(0) + \int_0^t \frac{d}{ds}W(s) ds.$$

Now, let $\alpha > 0$. Then,

$$\frac{d}{dt}V(t) \leq -\gamma\|x(t)\|^p \leq -\frac{\gamma}{\beta}V(t) \quad \text{a.e.}$$

Multiplication with the positive function $e^{\gamma t/\beta}$ gives

$$e^{\gamma t/\beta} \left(\frac{d}{dt}V(t) + \frac{\gamma}{\beta}V(t) \right) = \frac{d}{dt}(e^{\gamma t/\beta}V(t)) \leq 0 \quad \text{a.e.}$$

Letting $W(t) = e^{\gamma t/\beta}V(t)$ and noting that $W(t)$ is non-increasing we have

$$V(t^-)e^{\gamma t/\beta} \leq V(0) + \int_0^t \frac{d}{ds}V(s)e^{\gamma s/\beta} ds.$$

The inequality (4.1) and the fact that $V(t)$ is non-negative implies

$$V(t^-)e^{\gamma t/\beta} \leq V(0) - \frac{\gamma}{\beta} \int_0^t V(s).e^{\gamma s/\beta} ds \leq V(0)$$

Invoking the bounds (4.2) gives

$$\|x(t)\|^p \leq \frac{\beta}{\alpha} \|x(0)\|^p e^{-\gamma t/\beta}$$

which establishes exponential convergence.

Now, let the maximal α that satisfies (4.2) be negative. This implies that there is a time $t = t_0$ such that $V(t_0) = \alpha\|x(t_0)\| < 0$. Since $V(t)$ is non-increasing, (4.3) gives

$$V(t) \leq V(t_0) + \int_{t_0}^t \frac{d}{ds}V(s) ds \leq V(t_0) - \frac{\gamma}{\alpha} \int_{t_0}^t V(s) ds.$$

Since $V(t)$ is nonincreasing, we have $V(t) \leq V(t_0)$ for $t \geq t_0$ and

$$V(t) \leq \left(1 + (t - t_0) \frac{\gamma}{|\alpha|} \right) V(t_0).$$

Thus, $V(t) \rightarrow -\infty$ as $t \rightarrow \infty$ and by (4.2) it follows that $\|x(t)\|^p \rightarrow \infty$. \square

Note that the above result allows both verification of exponential stability and detection of instabilities. Moreover, the formulation does not require that $V(t)$ be continuous, as long as the value of $V(t)$ does not increase at the points of discontinuity.

4.2 Quadratic Stability

By quadratic stability, one refers to stability that can be established using a quadratic Lyapunov function. Quadratic stability dates back to the pioneering work of Lyapunov [89, 90], who established that the existence of a quadratic Lyapunov function is a necessary and sufficient condition for asymptotic stability of a linear system. Quadratic Lyapunov functions are often the first resort also in the analysis of nonlinear systems and much work on absolute stability is based on quadratic Lyapunov functions (see the discussion in [19]).

Quadratic Stability for Local Analysis

To verify exponential stability of a nonlinear system one may start by establishing exponential stability of the linearization. This is often done by eigenvalue inspection. One drawback with this approach is that one has no idea about the domain of validity of the analysis. In the piecewise linear framework the domain of validity of the linearization is incorporated in the model. By using Lyapunov function computations rather than eigenvalue inspection it is then possible to obtain a guaranteed domain of validity for the analysis. The following theorem establishes exponential stability of an equilibrium point, and also returns the largest domain of validity that can be guaranteed by a local analysis using a quadratic Lyapunov function, see [19].

PROPOSITION 4.1—[19]

Let $\dot{x} = Ax$ be valid in the polyhedron $X = \{x \mid g_k^T x \leq 1, \quad k = 1, \dots, p\}$. The origin is exponentially stable if and only if the convex optimization problem

$$\begin{array}{ll} \max_Q & \det Q^{-1} \\ \text{subject to} & Q > 0 \\ & QA^T + AQ < 0 \\ & g_k^T Q g_k \leq 1 \quad k = 1, \dots, p \end{array}$$

has a solution. Moreover, the ellipsoid $\mathcal{E}_{\text{roa}} = \{x \mid x^T Q^{-1} x \leq 1\}$ is the domain of attraction with largest volume in X that can be estimated using any quadratic Lyapunov function. \square

Proof: See [19], Section 5.2.

The strength of this proposition is that not only do the computations return a domain of validity for the analysis, but they actually return the largest region of attraction that can be estimated using any quadratic

Lyapunov function. In most cases, this domain is substantially larger than what may be obtained by simply solving the Lyapunov inequality

$$P > 0 \quad A^T P + PA = -R \quad (4.4)$$

for some arbitrary chosen positive definite matrix R . This is illustrated in the following example.

EXAMPLE 4.1—LOCAL ANALYSIS OF SATURATED SYSTEM
Consider the saturated linear system of Example 2.1,

$$\dot{x} = Ax + b \text{sat}(k^T x)$$

and let

$$A = \begin{bmatrix} 0 & 1 \\ 0 & 0 \end{bmatrix}, \quad b = \begin{bmatrix} 0 \\ 1 \end{bmatrix}, \quad k = \begin{bmatrix} -2 \\ -3 \end{bmatrix}.$$

Restricting the analysis to the unsaturated region, the polyhedron $|k^T x| \leq 1$, we can use Proposition 4.1 to verify exponential stability of the origin. The analysis returns the region of attraction shown in dashed lines in Figure 4.1. The region of attraction obtained by solving the Lyapunov equation (4.4) with $R = I$ only establishes stability for the domain showed as a filled ellipsoid in Figure 4.1. \square

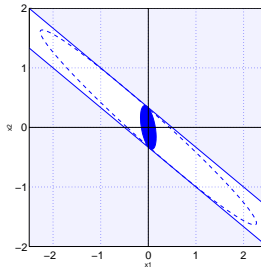

Figure 4.1 Linear (white) and saturated (shaded) regions in the state space. The maximal validity domain for analysis using a quadratic Lyapunov function obtained by Proposition 4.1 is the larger ellipsoid (dashed). The smaller (filled) ellipsoid is the domain of validity obtain from the Lyapunov equation (4.4).

In light of the above example, the results of Proposition 4.1 may appear surprisingly weak. Although the results are improved compared to a direct application of the Lyapunov inequality, exponential convergence has only been granted from initial values in a small neighborhood of the origin.

One should note, however, that the computed Lyapunov function may be able to verify stability also for the saturated regions but as these regions have not been used in the analysis of Proposition 4.1, no such conclusions can be drawn. This situation will appear repeatedly when we compute Lyapunov functions on a restricted domain. Stability can then be assured only for initial values starting within the largest level set of the computed Lyapunov function that is fully contained in the analysis domain.

Quadratic Stability for Global Analysis

Quadratic Lyapunov functions are often the first resort also for analysis of nonlinear systems. Many of these methods are somehow related to the analysis of the linear differential inclusion

$$\dot{x} \in \overline{\text{co}}\{A_1x, \dots, A_Lx\}. \quad (4.5)$$

In other words, they are related to the analysis of the family of linear time-varying systems that can be obtained as

$$\dot{x} = A(t)x = \sum_{i=1}^L \lambda_i(t) A_i x(t) \quad (4.6)$$

with $\lambda_i(t) \geq 0$ and $\sum_{i=1}^L \lambda_i(t) = 1$. The following result is central [48, 20].

PROPOSITION 4.2

Consider the system (4.5). If the convex optimization problem

$$P = P^T > 0 \quad (4.7)$$

$$A_i^T P + P A_i < 0 \quad i = 1, \dots, L \quad (4.8)$$

has a solution, then the origin is globally exponentially stable. \square

Proof: See Section A.3.

Note that Proposition 4.2 only gives sufficient conditions for stability. Since the Lyapunov function search of Proposition 4.2 is a convex optimization problem, a solution P can always be found if it exists. The sufficiency stems from the fact that quadratic Lyapunov functions are only sufficient for establishing stability of systems on the form (4.5), see [24, 25, 96]. We will discuss this issue in more detail at the end of this chapter.

The main advantage of Proposition 4.2 is that the search for a quadratic Lyapunov function has been formulated as a convex optimization

problem. The additional cost of imposing extra constraints on the form (4.8) is then comparatively low, and solving the multiple Lyapunov inequalities in Proposition 4.2 is not much more demanding than solving a single Lyapunov equation, see [19]. This makes quadratic stability a very powerful tool when applicable. There have been many applications of the above results to systems with piecewise linear dynamics, see for example the work on fuzzy systems [135, 156], which can be embedded in the linear time varying formulation (4.6) by the appropriate restrictions. The application to piecewise linear systems typically takes the following form.

COROLLARY 4.1

Consider the system (2.3), and assume that $a_i = 0$ for every $i \in I$. If the convex optimization problem (4.7), (4.8) has a solution, then every trajectory $x(t) \in \cup_{i \in I} X_i$ of (2.3) with $u \equiv 0$ tends to zero exponentially. \square

Proof: Note that we can write the system (2.3) on the form (4.6) for almost all t by setting $\lambda_i(t) = 1$ if x is in the interior of cell X_i and $\lambda_i(t) = 0$ otherwise. Since trajectories in the sense of Definition 2.1 do not remain on the boundary for any time interval, we do not need to define the dynamics on the cell boundaries. Continuity of $V(x)$ and $x(t)$ implies that $V(t) = V(x(t))$ is continuous for all t . The result now follows from Lemma 4.1.

In some cases, it is of interest to verify that no common solution P to the conditions of Proposition 4.2 exists. This verification can be done by solving the following dual problem (compare [11]).

PROPOSITION 4.3

If there exists positive definite matrices R_i satisfying

$$\begin{aligned} R_i &= R_i^T > 0 && \text{for } i \in I \\ \sum_{i \in I} (R_i A_i^T + A_i R_i) &> 0 \end{aligned}$$

then there exists no solution to the LMIs of Proposition 4.2. \square

Proof: If there exist R_i that solve the above inequalities, then for every $P > 0$, we have

$$0 < \text{tr}[P \sum_i (R_i A_i^T + A_i R_i)] = \sum_i \text{tr}[R_i (A_i^T P + P A_i)]$$

Hence, $0 < \text{tr}[R_i(A_i^T P + PA_i)]$ for some i , so $A_i^T P + PA_i$ can not be negative definite.

4.3 Conservatism of Quadratic Stability

Although quadratic stability is very powerful when it can be applied, there are several issues that make the quadratic stability analysis of piecewise linear systems given in Corollary 4.1 very conservative.

A first fact that one can notice is that no affine terms are permitted in the dynamics, and a simple system such as the saturated control system of Example 4.1 can not be analyzed as it stands.

The second issue is that no information of the partition is used in the analysis. Rather than using the fact that a certain dynamic system is only valid in a restricted domain of the continuous state space, the piecewise linear dynamics is embedded in a (possibly large) differential inclusion. The following example illustrates the limitations of the approach.

EXAMPLE 4.2—THE NEED TO USE PARTITION INFORMATION
 Consider the piecewise linear system

$$\dot{x} = \begin{cases} \begin{bmatrix} -0.1 & 1 \\ -10 & -0.1 \end{bmatrix} x & x_1 x_2 \geq 0 \\ \begin{bmatrix} -0.1 & 10 \\ -1 & -0.1 \end{bmatrix} x & x_1 x_2 < 0 \end{cases} \quad (4.9)$$

The system matrices are stable and have the same eigenvalues. The simulation shown in Figure 4.2 (left) indicates that the system is stable. It is straightforward to verify that $V(x) = x^T x$ is a Lyapunov function for the system, yet there is no solution to the LMI conditions in Proposition 4.2.

We can understand this by interchanging the system matrices in the model (4.9). Simulating this system yields unbounded trajectories, see Figure 4.2(right). Since stability depends on the partition, the standard LMI conditions can not prove stability. At the end of this chapter, we will be able to return to this example with a more powerful toolset and prove stability of the initial setup. \square

A third limitation is of course that many systems do not admit a quadratic Lyapunov function. The following example illustrates a simple system that can not be analyzed using quadratic Lyapunov functions.

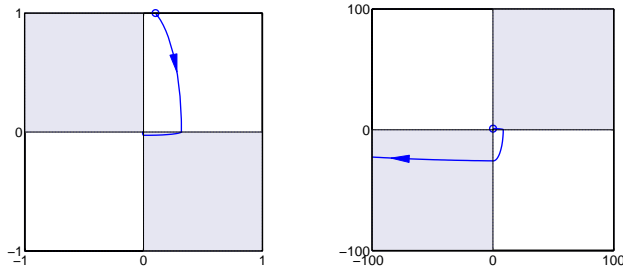

Figure 4.2 The original setup is exponentially stable, while interchanging the two system matrices gives an unstable system (note the different scalings!). Thus, stability can not be proved without taking the structural information into account.

EXAMPLE 4.3—THE NEED FOR NON-QUADRATIC LYAPUNOV FUNCTIONS

Consider the piecewise linear system $\dot{x}(t) = A_i x(t)$ with the cell partition shown in Figure 4.3 and system matrices

$$A_1 = A_3 = \begin{bmatrix} -\varepsilon & \omega \\ -\alpha\omega & -\varepsilon \end{bmatrix}, \quad A_2 = A_4 = \begin{bmatrix} -\varepsilon & \alpha\omega \\ -\omega & -\varepsilon \end{bmatrix}.$$

Letting $\alpha = 5$, $\omega = 1$ and $\varepsilon = 0.1$, the trajectory of a simulation with initial value $x_0 = (-2, 0)^T$ moves towards the origin in a flower-like trajectory, as shown in Figure 4.3. Clearly, no quadratic Lyapunov function can generate level sets with the property that a trajectory that enters a level set remains within this set for all future times. Hence, there is no obvious quadratic Lyapunov function that guarantees asymptotic stability of the system.

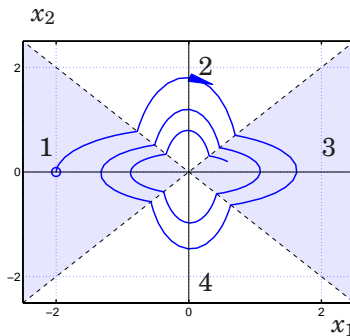

Figure 4.3 Simulated trajectory (full) and cell boundaries (dashed) in Example 4.3.

□

From a computational viewpoint, quadratic stability is very attractive. It allows analysis of complex systems to be cast as convex optimization problems that can be solved using very efficient numerical computations. However, as demonstrated above, there are some important shortcomings of the quadratic stability when applied to piecewise linear systems. Firstly, it can be very conservative to only consider quadratic Lyapunov functions. Moreover, in the standard results for quadratic stability no information about the state space partition is used in the analysis and no affine terms are permitted in the dynamics.

In the following pages we will develop an approach that does not suffer from these shortcomings. The method will be based on non-quadratic Lyapunov functions, take partition information into account and allow affine terms in the dynamics. All analysis conditions will be formulated as convex optimization problems, allowing piecewise linear systems to be analyzed using efficient numerical computations.

4.4 From Quadratic to Piecewise Quadratic

To find inspiration for alternatives to the globally quadratic Lyapunov functions, we will analyze the simple selector control system as shown in Figure 4.4. Selector control is a common solution for constraint handling

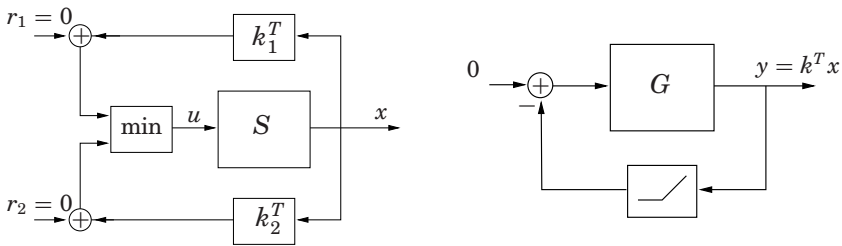

Figure 4.4 Selector control system (left) transformed into feedback form (right).

in process industry, see *e.g.* [4, 41, 21], and selector strategies often result in systems with piecewise linear dynamics.

Consider the system in Figure 4.4 and let $r_1 = r_2 = 0$. We assume that S is a linear system $\dot{x} = Ax + Bu$. Then, the closed loop dynamics can be written as

$$\dot{x} = Ax + B \min(k_1^T x, k_2^T x).$$

The min-function induces a piecewise linear system with dynamics

$$\dot{x} = \begin{cases} (A + Bk_1^T)x & \text{if } k_1^T x \leq k_2^T x, \\ (A + Bk_2^T)x & \text{if } k_2^T x \leq k_1^T x. \end{cases}$$

Letting $k = k_1 - k_2$, $A_1 = A + Bk_1^T$ and $A_2 = A_1 + Bk_2^T$, we obtain

$$\dot{x} = \begin{cases} A_1 x & \text{if } k^T x \leq 0, \\ A_2 x & \text{if } k^T x \geq 0. \end{cases}$$

Now, consider the particular system defined by

$$A_1 = \begin{bmatrix} -5 & -4 \\ -1 & -2 \end{bmatrix}, \quad B = \begin{bmatrix} -3 \\ -21 \end{bmatrix}, \quad k = \begin{bmatrix} 1 \\ 0 \end{bmatrix}.$$

By solving the dual problem stated in Proposition 4.3, one can verify that there is no globally quadratic Lyapunov function $V(x) = x^T P x$ that verifies stability of the system. Still, the simulations shown in Figure 4.5(left) indicate that the system is stable.

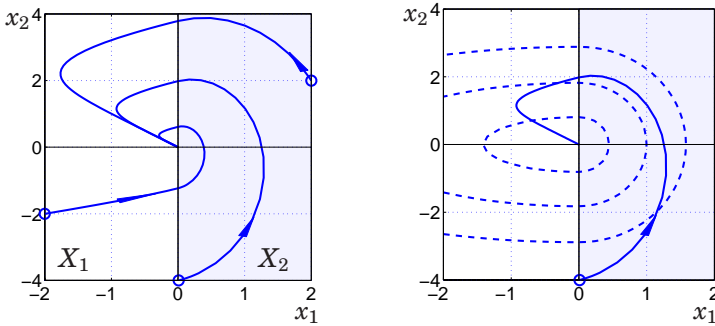

Figure 4.5 Trajectories in the phase plane of the selector control system.

As an alternative to a globally quadratic Lyapunov function, it is natural to consider the following Lyapunov function candidate

$$V(x) = \begin{cases} x^T P x, & \text{if } k^T x < 0 \\ x^T P x + \eta(k^T x)^2, & \text{if } k^T x \geq 0 \end{cases} \quad (4.10)$$

where P and $\eta \in \mathbb{R}$ are chosen so that both quadratic forms are positive definite. Note that the Lyapunov function candidate is constructed to be

continuous and piecewise quadratic. The search for appropriate values of η and P can be done by solving the following linear matrix inequalities

$$\begin{aligned} P = P^T > 0, & & P + \eta k k^T > 0, \\ A_1^T P + P A_1 < 0 & & A_2^T (P + \eta k k^T) + (P + \eta k k^T) A_2 < 0. \end{aligned}$$

One feasible solution is given by $P = \text{diag}\{1, 3\}$ and $\eta = 9$. The level surfaces of the computed Lyapunov function are indicated in Figure 4.5.

Relation to Frequency Domain Criteria

It is instructive to compare this solution with what can be achieved using frequency domain methods such as the circle and Popov criteria. Noting that $A_2 = A_1 - B k^T$ we can re-write the system equation as

$$\begin{aligned} \dot{x} &= A_1 x - B \varphi(k^T x) \\ \varphi(y) &= \begin{cases} 0, & \text{if } y \leq 0 \\ y, & \text{if } y \geq 0 \end{cases} \end{aligned} \quad (4.11)$$

Defining $G(s) = k^T (sI - A_1)^{-1} B$, we obtain the frequency condition

$$\text{Re } G(i\omega) > -1, \quad \forall \omega \in [0, \infty]$$

for the circle criterion and

$$\text{Re } [(1 + i\omega\eta)G(i\omega)] > -1, \quad \forall \omega \in [0, \infty]$$

for the Popov criterion. Inspection of the Nyquist and Popov plots of Figure 4.6 reveals that stability follows from the Popov criterion but not from the circle criterion. The failure of the circle criterion comes as no surprise, as the circle criterion relies on the existence of a common Lyapunov function on the form $V(x) = x^T P x$ [78] which we know does not exist. The standard proof of the Popov criteria, on the other hand, uses the Lyapunov function

$$V(x) = x^T P x + 2\eta \int_0^{k^T x} \varphi(\sigma) d\sigma. \quad (4.12)$$

By evaluating this function for the nonlinearity (4.11) one recovers the Lyapunov function candidate (4.10) which was used in the numerical optimization above.

It is not hard to establish that all Lyapunov function of Lure-type

$$V(x) = x^T P x + \int_0^z \varphi(z) dz$$

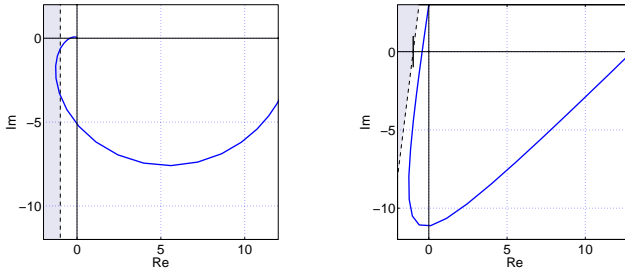

Figure 4.6 The circle criterion (left) fails to prove stability. The Popov plot (right) is separated from -1 by a straight line of slope $1/\eta$. Hence stability follows.

constructed from piecewise linear functions $\varphi(z)$ are continuous and piecewise quadratic. However, rather than tailoring the analysis to linear systems interconnected with scalar nonlinearities, we will aim for results that are applicable to general piecewise linear systems. Motivated by the examples above we will employ Lyapunov functions that are continuous and piecewise quadratic.

4.5 Interlude: Describing Partition Properties

To support the Lyapunov function search, we will introduce a compact matrix parameterization of continuous piecewise quadratic Lyapunov functions. Moreover, to avoid excessive conservatism we will exploit the fact each affine dynamics is used in a limited region of the state space. The aim of this section is to introduce a matrix format for describing these central partition properties. Procedures for constructing the necessary constraint matrices from partition data will be given in Chapter 8.

Similar to the example above, we will use Lyapunov functions that are continuous and piecewise quadratic. A fundamental problem in the search for such functions is how the continuity constraint should be enforced on the Lyapunov function candidate. One solution is of course to patch together piecewise quadratics “by hand”, as was done in the analysis of the selector system. If we only require continuity of the piecewise quadratics, we can allow less restrictive updates in the quadratic forms than the update $\eta k k^T$ used above. To illustrate this, let

$$V_i(x) = x^T P_i x + 2q_i^T x_i + r_i = \begin{bmatrix} x \\ 1 \end{bmatrix}^T \begin{bmatrix} P_i & q_i \\ q_i^T & r_i \end{bmatrix} \begin{bmatrix} x \\ 1 \end{bmatrix} := \bar{x}^T \bar{P}_i \bar{x}$$

be a quadratic function defined for $x \in X_i$. Consider two cells X_i and X_j with boundary hyperplane $\mathcal{H}_{ij} = \{x \mid h_{ij}^T x + g_{ij} = 0\}$. To obtain continuity across the boundary hyperplane,

$$V_i(x) = V_j(x) \quad \forall x \in \mathcal{H}_{ij}$$

there must exist $t_{ij} \in \mathbb{R}^n$ and $s_{ij} \in \mathbb{R}$ such that

$$V_i(x) = V_j(x) + 2(h_{ij}^T x + g_{ij})(t_{ij}^T x + s_{ij}).$$

Letting $\bar{h}_{ij} = [h_{ij}^T \quad g_{ij}]^T$ and $\bar{t}_{ij} = [t_{ij}^T \quad s_{ij}]^T$, this condition reads

$$\bar{P}_j = \bar{P}_i + \bar{h}_{ij} \bar{t}_{ij}^T + \bar{t}_{ij} \bar{h}_{ij}^T. \quad (4.13)$$

Although the above equation must be satisfied on each cell boundary, it is not useful for construction of explicit expressions for the matrices \bar{P}_i other than in very simple examples. We will therefore introduce a compact matrix parameterization of continuous piecewise quadratic functions on polyhedral partitions. In most cases we would also like that the computed function satisfies the interpolation property that it evaluates to zero for zero argument. The parameterization is based on continuity matrices, as defined below.

DEFINITION 4.1—CONTINUITY MATRIX

A matrix $\bar{F}_i = [F_i \quad f_i]$ is a continuity matrix for cell X_i if

$$\bar{F}_i \bar{x}(t) = \bar{F}_j \bar{x}(t) \quad \text{for } x(t) \in X_i \cap X_j. \quad (4.14)$$

Furthermore, we say that \bar{F}_i has the zero interpolation property if

$$f_i = 0 \quad \text{for } i \in I_0. \quad (4.15)$$

□

A format for continuous piecewise quadratic functions can now be obtained as follows.

LEMMA 4.2—PWQ PARAMETERIZATION

Let $\{X_i\}_{i \in I}$ be a polyhedral partition, and let $\bar{F}_i \in \mathbb{R}^{p \times (n+1)}$ be continuity matrices that satisfy (4.14). Then, for each $T \in \mathbb{R}^{p \times p}$, the scalar function

$$V(x) = \bar{x}^T \bar{F}_i^T T \bar{F}_i \bar{x} := \bar{x}^T \bar{P}_i \bar{x} \quad \text{for } x \in X_i.$$

is continuous and piecewise quadratic. Moreover, if each \bar{F}_i has the zero interpolation property, then there exist α and β such that

$$\alpha \|x\|_2^2 \leq V(x) \leq \beta \|x\|_2^2. \quad (4.16)$$

□

Proof: Obviously, $V(x)$ is piecewise quadratic. Continuity of $V(x)$ follows from (4.14). The only obstacle in establishing (4.16) can occur around the origin. However, the zero interpolation property guarantees that $V(x)$ has no affine terms in regions that contain the origin, *i.e.*,

$$V(x) = \bar{x}^T \bar{P}_i \bar{x} = x^T F_i^T F_i x := x^T P_i x, \quad x \in X_i, i \in I_0$$

and the desired result follows.

Note that the continuity matrices for a given partition are not unique. One could for instance use the following matrix in all regions,

$$\bar{F}_i = [I_{n \times n} \quad 0_{n \times 1}] \quad i \in I.$$

Using the parameterization of Lemma 4.2 we would then obtain a Lyapunov function candidate which is globally quadratic. Clearly, one would like a way of constructing the continuity matrices that gives maximal freedom in the Lyapunov function search. We will comment on this issue later. The following example illustrates one choice of continuity matrices for the saturated system in Example 2.1.

EXAMPLE 4.4—CONTINUITY MATRICES FOR SATURATED SYSTEM

The following matrices are natural continuity matrices for the saturated feedback system in Example 2.1.

$$\bar{F}_1 = \begin{bmatrix} -k^T & -1 \\ 0_{1 \times n} & 0 \\ I_{2 \times 2} & 0 \end{bmatrix}, \quad \bar{F}_2 = \begin{bmatrix} 0_{1 \times n} & 0 \\ 0_{1 \times n} & 0 \\ I_{2 \times 2} & 0 \end{bmatrix}, \quad \bar{F}_3 = \begin{bmatrix} 0_{1 \times n} & 0 \\ k^T & -1 \\ I_{2 \times 2} & 0 \end{bmatrix}.$$

Note that the matrices have the zero interpolation property and that a Lyapunov function candidate constructed as in Lemma 4.2 has no affine terms in the region that contains the origin. □

As discussed in Chapter 2, the operating regimes can be described by matrices \bar{G}_i with the property that

$$\bar{G}_i \bar{x}(t) \succeq 0 \quad \text{if and only if } x(t) \in X_i. \quad (4.17)$$

We named these matrices cell identifiers since they express whether a certain x belongs to cell X_i or not. In some computations, we will need to express the restriction that $x \in X_i$ via a linear form in x . Since the cell identifiers use affine forms in general, the \bar{G}_i -matrices can not be used directly. We therefore define *cell boundings* as follows.

DEFINITION 4.2—POLYHEDRAL CELL BOUNDING

A matrix $\bar{E}_i = [\bar{E}_i \ e_i]$ is called a cell bounding if it satisfies

$$\bar{E}_i \bar{x}(t) \succeq 0 \quad \text{if } x(t) \in X_i. \quad (4.18)$$

Furthermore, we say that \bar{E}_i has the zero interpolation property if

$$e_i = 0 \quad \text{if } i \in I_0. \quad (4.19)$$

□

Note that while a cell identifier can be used to determine if $x \in X_i$, this is not necessarily the case for cell boundings. For example, the zero matrix will always qualify as cell bounding (although this choice is of little use in most cases). Still, there is a close relationship between the two notions. More precisely, the following procedure shows how cell boundings with the zero interpolation property can be computed from the corresponding cell identifiers.

ALGORITHM 4.1—FROM CELL IDENTIFIER TO CELL BOUNDING

Let $\{X_i\}_{i \in I}$ be a polyhedral partition with associated cell identifiers \bar{G}_i . The corresponding cell boundings can be computed as follows.

If $i \in I_0$, then \bar{E}_i is obtained by deleting all rows of \bar{G}_i whose last entry is nonzero.

If $i \in I_1$ and there is only one non-zero entry in the last column of \bar{G}_i , then \bar{E}_i is obtained by augmenting \bar{G}_i with the row $[0_{1 \times n} \ 1]$, otherwise $\bar{E}_i = \bar{G}_i$.

□

Before motivating the suggested procedure in detail, we illustrate the application of Algorithm 4.1 on the saturated system.

EXAMPLE 4.5—CELL BOUNDING FOR SATURATED SYSTEM

Applying Algorithm 4.1 to the cell identifiers of the saturated system in Example 2.1, we obtain the following cell boundings.

$$\bar{E}_1 = \begin{bmatrix} -k^T & -1 \\ 0_{1 \times n} & 1 \end{bmatrix}, \quad \bar{E}_2 = \begin{bmatrix} 0_{1 \times n} & 0 \\ 0_{1 \times n} & 0 \end{bmatrix}, \quad \bar{E}_3 = \begin{bmatrix} k^T & -1 \\ 0_{1 \times n} & 1 \end{bmatrix}.$$

□

One may ask if there is any loss in using cell boundings rather than cell identifiers in conditional analysis of piecewise quadratic functions. The following lemma states that this is not the case.

LEMMA 4.3

Consider the piecewise quadratic function $V(x)$ constructed in Lemma 4.2 and let \bar{E}_i be cell boundings constructed using Algorithm 4.1. Then \bar{E}_i have the zero interpolation property, and

$$V(x) > 0 \quad \text{for } \{x \mid \bar{G}_i \bar{x} \geq 0\}$$

if and only if

$$V(x) > 0 \quad \text{for } \{x \mid \bar{E}_i \bar{x} \geq 0\}.$$

□

Proof: See Appendix A.3.

As discussed above, the purpose of the cell boundings is to be able to verify that a piecewise quadratic function is positive (or negative) in a certain cell. The following lemma shows how this verification can be cast as a linear matrix inequality condition.

LEMMA 4.4

Consider the function

$$V(x) = \bar{x}^T \bar{P}_i \bar{x} \quad \text{for } x \in X_i,$$

with $\bar{P}_i = \bar{P}_i^T$ and let \bar{E}_i be a cell bounding satisfying (4.18). If there exists a matrix W_i with nonnegative entries, $W_i \succeq 0$, such that

$$\bar{P}_i - \bar{E}_i^T W_i \bar{E}_i > 0 \quad (4.20)$$

then $V(x) > 0$ for all $x \in X_i$ with $x \neq 0$. □

Proof: A solution to the inequality (4.20) guarantees that

$$z^T \bar{P}_i z - z^T \bar{E}_i^T W_i \bar{E}_i z > 0$$

for any $z \in \mathbb{R}^{n+1} \setminus \{0\}$. Let $z = \bar{x}$. Since $\bar{x}^T \bar{E}_i^T W_i \bar{E}_i \bar{x} \geq 0$ for $x \in X_i$, we have

$$V(x) = \bar{x}^T \bar{P}_i \bar{x} > \bar{x}^T \bar{E}_i^T W_i \bar{E}_i \bar{x} \geq 0 \quad \text{for } x \neq 0 \text{ with } x \in X_i.$$

Hence, $V(x) > 0$ for $x \neq 0$, and the assertion follows.

The technique used in Lemma 4.4 is known as the S -procedure, see [1, 153, 19]. Intuitively, the point with this approach is that if $\bar{x}^T \bar{E}_i^T W_i \bar{E}_i \bar{x} < 0$ for $x \notin X_i$, the inequality (4.20) may be simpler to satisfy than the corresponding LMI without relaxation term. Although this approach is conservative in general it is very useful in practice. For some situations, the S -procedure is both a necessary and a sufficient way to account for quadratic constraints, see [153, 19]. The specific way we construct a relaxation term from affine constraint can be seen as a special case of Shor's relaxation used in non-convex and combinatorial optimization, see [128, 112].

4.6 Piecewise Quadratic Lyapunov Functions

The previous section has laid the grounds for analysis of piecewise linear systems using piecewise quadratic Lyapunov functions. In Lemma 4.2, we proposed a format for continuous piecewise quadratic functions. This format separates the degrees of freedom in the function from the constraints imposed by the partition and the continuity requirement. In Lemma 4.4, we showed how it is possible to verify positivity (and hence negativity) of a piecewise quadratic function on a polyhedral domain by solving a linear matrix inequality. We will now combine these results to formulate the search for piecewise quadratic Lyapunov functions on the form

$$V(x) = \begin{cases} x^T P_i x & \text{for } x \in X_i, i \in I_0 \\ \begin{bmatrix} x \\ 1 \end{bmatrix}^T \bar{P}_i \begin{bmatrix} x \\ 1 \end{bmatrix} = x^T P_i x + 2q_i^T x + r_i & \text{for } x \in X_i, i \in I_1. \end{cases} \quad (4.21)$$

More precisely, we have the following result.

THEOREM 4.1—PIECEWISE QUADRATIC STABILITY

Consider symmetric matrices T , U_i and W_i such that U_i and W_i have nonnegative entries, while

$$\begin{aligned} P_i &= F_i^T T F_i, & i \in I_0 \\ \bar{P}_i &= \bar{F}_i^T T \bar{F}_i, & i \in I_1 \end{aligned}$$

satisfy

$$\begin{cases} 0 > A_i^T P_i + P_i A_i + E_i^T U_i E_i \\ 0 < P_i - E_i^T W_i E_i \end{cases} \quad i \in I_0$$

$$\begin{cases} 0 > \bar{A}_i^T \bar{P}_i + \bar{P}_i \bar{A}_i + \bar{E}_i^T U_i \bar{E}_i \\ 0 < \bar{P}_i - \bar{E}_i^T W_i \bar{E}_i \end{cases} \quad i \in I_1$$

Then every trajectory $x(t) \in \cup_{i \in I} X_i$ satisfying (2.3) with $u \equiv 0$ for all $t \geq 0$ tends to zero exponentially. \square

Proof: Consider the Lyapunov function candidate $V(t) = V(x(t))$ defined by (4.21). Since trajectories $x(t)$ in the sense of Definition 2.1 are continuous and piecewise C^1 , Lemma 4.2 implies that $V(t)$ constructed in this way is continuous and piecewise C^1 . Moreover, according to Lemma 4.2, there exists $\beta > 0$ such that the upper bound of (4.2) in Lemma 4.1 holds. A solution to the inequalities above implies that there exists $\alpha > 0$ and $\gamma > 0$ such that $\alpha \|x(t)\|_2^2 < V(t)$ and $dV(t)/dt < -\gamma \|x(t)\|_2^2$. Hence, exponential convergence follows from Lemma 4.1 with $\|\cdot\| = \|\cdot\|_2$ and $p = 2$.

Since Theorem 4.1 only considers trajectories defined for all $t \geq 0$, no conclusion can be drawn about trajectories that end up in attractive sliding modes. In the absence of attractive sliding modes, the above conditions assure that (4.21) is a Lyapunov function for the system. The first LMI condition for each region assures that the Lyapunov function decreases along system trajectories, $\dot{V}(x(t)) < 0$, while the second condition assures positivity, $V(x(t)) > 0$. Any level set of $V(x)$ that is fully contained in the partition $\cup_{i \in I} X_i$ is a region of attraction for the equilibrium $x = 0$. In particular, if the partition covers the whole state space then the system is globally exponentially stable. If no solution can be found to the conditions of Theorem 4.1 for a given partition, it is natural to refine the partition and to try again. Such partition refinements increase the flexibility of the Lyapunov function candidate (4.21).

With the piecewise quadratic stability theorem at hand, we can return to the motivating examples where the standard LMI conditions for quadratic stability failed.

EXAMPLE 4.6—PIECEWISE QUADRATIC WHERE QUADRATIC FAILS

Consider the system (4.9) in Example 4.2. Let E_i denote the cell bounding used in quadrant i . Setting

$$E_1 = -E_3 = \begin{bmatrix} 1 & 0 \\ 0 & 1 \end{bmatrix}, \quad E_2 = -E_4 = \begin{bmatrix} -1 & 0 \\ 0 & 1 \end{bmatrix},$$

and $F_i = [E_i^T \ I_n]^T$ we invoke Theorem 4.1 and find a feasible solution

$$V(x) = x^T x \quad x \in X_i, i \in I.$$

Hence, stability can indeed be proved using a quadratic Lyapunov function but one needs to account for the composition of the state space partition. The level curves of the computed Lyapunov function are shown together with a simulation in Figure 4.7(left).

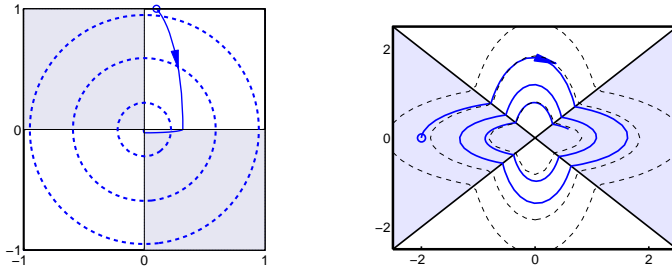

Figure 4.7 Level surfaces (dashed) for the systems in Example 4.2 and Example 4.3 computed using Theorem 4.1. In both cases, the standard conditions for quadratic stability fail while Theorem 4.1 verifies stability.

As a second example, consider the system with flower-like trajectories used in Example 4.3. Similarly as above, we let

$$E_1 = -E_3 = \begin{bmatrix} -1 & 1 \\ -1 & -1 \end{bmatrix}, \quad E_2 = -E_4 = \begin{bmatrix} -1 & 1 \\ 1 & 1 \end{bmatrix},$$

and $F_i = [E_i^T \ I_n]^T$. From the conditions of Theorem 4.1 we find the piecewise quadratic Lyapunov function $V(x) = x^T P_i x$ with

$$P_1 = P_3 = \begin{bmatrix} 5 & 0 \\ 0 & 1 \end{bmatrix}, \quad P_2 = P_4 = \begin{bmatrix} 1 & 0 \\ 0 & 5 \end{bmatrix}.$$

As seen in Figure 4.7(right), the level surfaces of the computed Lyapunov function are neatly tailored to the system trajectories. \square

Theorem 4.1 only treats systems that do not have attractive sliding modes. Thus, in order to be able to conclude stability for every possible behavior of the model (2.3), we must rule out the possibility of attractive sliding modes. A direct application of Proposition 3.4 verifies the absence of attractive sliding modes for the systems in Example 4.6. For systems with attractive sliding modes one has to extend the analysis conditions. Such extensions will be made in Section 4.11.

Analysis of a Min-Max Selector System

The examples analyzed so far have been small examples in two dimensions, constructed to illustrate the shortcomings of quadratic and merits of piecewise quadratic Lyapunov functions. Our next example is motivated by industrial applications, has higher state dimension and a nonlinearity that is not easily treated with absolute stability techniques.

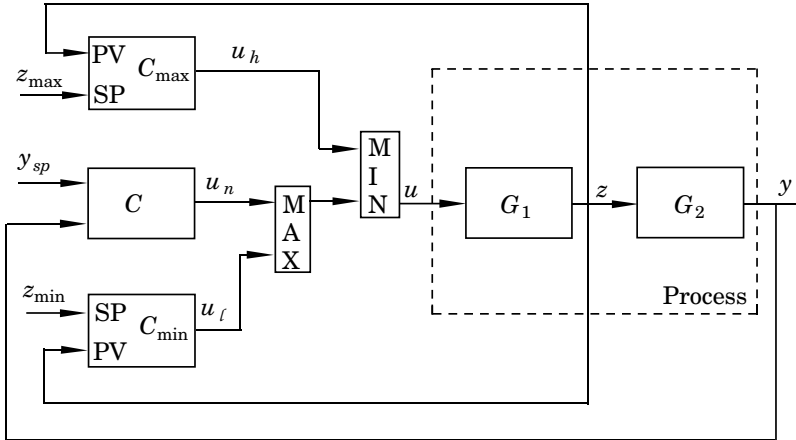

Figure 4.8 Control system with min/max selectors, from [4].

The example is the min-max selector control system shown in Figure 4.8. This scheme is common in situations where several process variables have to be taken into account using a single control signal. In Figure 4.8, y is the primary variable, and z is a process variable that must remain within given ranges. The controller C is designed to control the primary variable, while the controllers C_{max} and C_{min} are designed to keep the critical variable z within certain bounds. Designed correctly, the min-max selector chooses the controller that is most appropriate for the situation, and allows good control of the primary variable while respecting the constraints.

Consider a system characterized by

$$G_1(s) = \frac{40}{0.05s^3 + 2s^2 + 22s + 40},$$

$$G_2(s) = \frac{5}{s^2 + 7s + 5}.$$

To control the primary variable, we design a lead-lag controller

$$C(s) = \frac{s^2 + 3s + 3}{0.02s^2 + s + 0.01},$$

while C_{min} and C_{max} are proportional controllers

$$\begin{aligned} u_h &= K_h(z_{max} - z), \\ u_l &= K_l(z_l - z). \end{aligned}$$

The plots in Figure 4.9 show a simulation of the system without constraint controllers. The tracking of the primary variable is quite good, but the critical variable z exceeds its constraint limits (shown in dashed lines). The plots in Figure 4.10 show a simulation of the min-max selector strategy. The constraints are now respected while the tracking of the primary variable remains satisfactory.

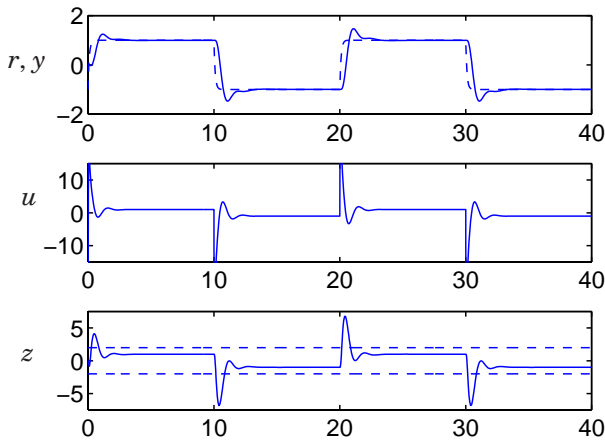

Figure 4.9 Simulation of the control system in Figure 4.8 without constraint handling. The tracking of the primary variable is quite good (top), but the critical variable exceeds its limits (bottom).

We will apply Theorem 4.1 to stability analysis of the system for a constant set-point y_{sp} and constant constraint limits z_{min}, z_{max} on the critical variable. Different values of y_{sp}, z_{min} and z_{max} result in different equilibrium points. For sake of simplicity, we will let $y_{sp} = z_{max} = z_{min} = 0$, but the technique would apply similarly to any choice of these constant inputs.

For analysis purposes, it is convenient to re-write the system equations as a linear system interconnected with the static nonlinearity

$$u = \min(u_h, \max(u_n, u_l)).$$

The full details for this step are given in Section B.1. The selector nonlinearity has three input signals u_h, u_n, u_l and one output, u . Similar to

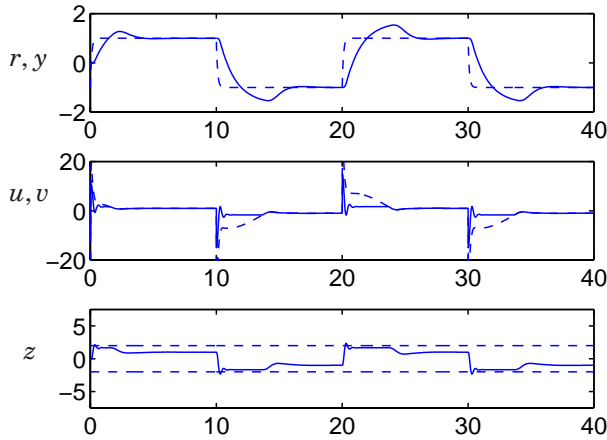

Figure 4.10 Simulation of the min-max selector system. The constraint limits are respected (bottom), while the tracking of the primary variable is still satisfactory (top). The middle plot shows how the constraint controllers override the primary control signal (dashed) resulting in a control (full) that respects the constraints.

the simpler system used as motivating example in Section 4.4, we can reduce the number of inputs by one using a simple loop transformation. This results in the system shown in Figure 4.11. The transformed system

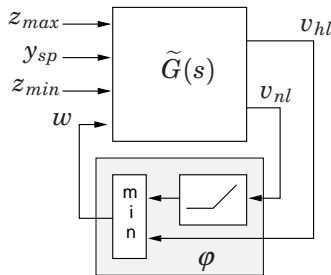

Figure 4.11 Selector control system rewritten as linear system interconnected with a static multi-variable nonlinearity.

has two outputs v_{hl} and v_{nl} , and the selector nonlinearity is now reduced to the two-dimensional mapping $\varphi(v_{hl}, v_{nl})$ shown in Figure 4.12. The

nonlinearity φ is piecewise linear, and has the explicit expression

$$\varphi = \begin{cases} 0 & \text{if } v_{hl} \geq 0, \quad v_{nl} \leq 0 \\ v_{nl} & \text{if } v_{nl} \geq 0, \quad v_{hl} \geq v_{nl} . \\ v_{hl} & \text{otherwise} \end{cases}$$

Since the region where $\varphi(v_{hl}, v_{nl}) = v_{hl}$ is not convex, we have to introduce an additional region, see Figure 4.12(right).

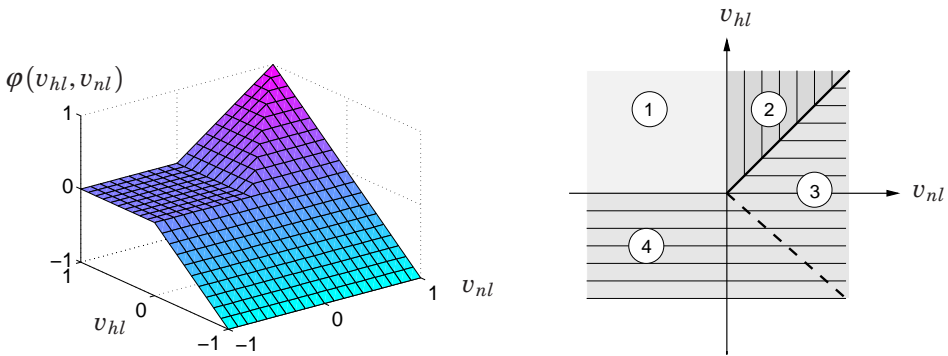

Figure 4.12 Static nonlinearity in the selector control system (left). The corresponding non-convex state partition (right) is rendered convex by splitting one cell in two (the dashed line in rightmost figure).

While this nonlinearity fits directly in the piecewise linear framework, it is not easily dealt with using other techniques. It is easy to verify that the nonlinearity has gain less than one, which motivates an attempt to apply the small gain theorem. However, the \mathcal{L}_2 -induced gain of the linear system is 15.8, and the small gain can not verify stability. An approach based on linear differential inclusions (Corollary 4.1) also fails.

In contrast, a numerical stability analysis using Theorem 4.1 verifies system stability. In this case, the optimization routines return a Lyapunov function which is globally quadratic. Since Corollary 4.1 fails, this example shows the importance of using partition information in the analysis.

It may appear strange to let $z_{min} = z_{max} = 0$ in the analysis. This choice was made for sake of simplicity, and similar results could be obtained for any choice of z_{min} and z_{max} . The analysis only considers stability of an equilibrium point. Such an analysis is particularly interesting for verifying that no undesired switching occurs.

4.7 Analysis of Uncertain Systems

The LMI computations of Theorem 4.1 are readily extended to systems described by piecewise linear differential inclusions (pwLDIs), as defined in Section 2.3. We let $K(i)$ be the set of extreme dynamics that define the system behavior in cell X_i and consider the system

$$\dot{x} \in \overline{\text{co}}_{k \in K(i)} \{A_k x + a_k\} \quad x \in X_i.$$

In order to guarantee that the Lyapunov function is decreasing for all possible solutions of the pwLDI, we must require that the Lyapunov function is decreasing with respect to every extreme dynamics $\dot{x} = A_k x + a_k$ that defines the inclusion in each cell. This leads to multiple decreasing conditions in each region, one for each extreme dynamics. The discussion is made more precise in the following theorem.

THEOREM 4.2—PWQ STABILITY OF PWLDIS

Consider symmetric matrices T , U_{ik} and W_{ik} such that U_{ik} and W_{ik} have nonnegative entries, while

$$\begin{aligned} P_i &= F_i^T T F_i, & i \in I_0 \\ \bar{P}_i &= \bar{F}_i^T T \bar{F}_i, & i \in I_1 \end{aligned}$$

satisfy

$$\begin{cases} 0 > A_k^T P_i + P_i A_k + E_i^T U_{ik} E_i \\ 0 < P_i - E_i^T W_{ik} E_i \end{cases} \quad i \in I_0, \quad k \in K(i)$$

$$\begin{cases} 0 > \bar{A}_k^T \bar{P}_i + \bar{P}_i \bar{A}_k + \bar{E}_i^T U_{ik} \bar{E}_i \\ 0 < \bar{P}_i - \bar{E}_i^T W_{ik} \bar{E}_i \end{cases} \quad i \in I_1, \quad k \in K(i)$$

Then every trajectory $x(t) \in \cup_{i \in I} X_i$ satisfying the inclusion (2.9) with $u \equiv 0$ for $t \geq 0$ tends to zero exponentially. \square

Proof: Follows similarly to Theorem 4.1 and Proposition 4.2.

Theorem 4.2 enables the use of the piecewise quadratic machinery for rigorous stability analysis of smooth nonlinear systems. We will develop this approach in further detail in Chapter 7, but illustrate the ideas on the following example.

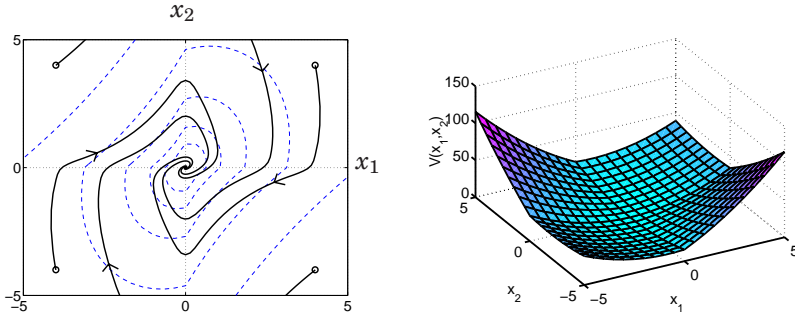

Figure 4.13 The left figure shows simulations (full) and Lyapunov function level surfaces (dashed) obtained in Example 4.7. The right figure shows the computed Lyapunov function.

EXAMPLE 4.7—EMBEDDING SMOOTH SYSTEMS IN PWLDIS

Simulations indicate that the following nonlinear system is stable

$$\begin{aligned} \dot{x}_1 &= -2x_1 + 2x_2 + \text{sat}(x_1x_2)x_1 \\ \dot{x}_2 &= -2x_1 - \text{sat}(x_1x_2)(x_1 + 4x_2). \end{aligned}$$

We would like to verify global exponential stability of the origin by computing a piecewise quadratic Lyapunov function for the system. A simple technique for rigorous analysis of the system is to explore the bounds

$$p_{min} \leq \text{sat}(x_1x_2) \leq p_{max}$$

and re-write the model as the differential inclusion

$$\dot{x} = \begin{bmatrix} -2 & 2 \\ -2 & 0 \end{bmatrix} x + p(t) \begin{bmatrix} 1 & 0 \\ -1 & -4 \end{bmatrix} x \quad (4.22)$$

with $p_{min} \leq p(t) \leq p_{max}$. By using information about the nonlinearity $p(t) = \text{sat}(x_1x_2)$ we can obtain pwLDIs of different accuracy. First, notice that analysis using a global model based on the bound $-1 \leq p(t) \leq 1$ is futile, since $p(t) = -1$ gives an unstable extreme dynamics. Taking the step from linear analysis to piecewise linear analysis, we can obtain a refined model by exploring the fact that

$$0 \leq \text{sat}(x_1x_2) \leq 1$$

in the first and third quadrant, and

$$-1 \leq \text{sat}(x_1x_2) \leq 0$$

in the second and fourth quadrant. This observation motivates a model with four regions, each region covering one quadrant. The dynamics in each region is given by a linear differential inclusion on the form (2.9). To verify stability, we apply Theorem 4.2 and find the Lyapunov function with the level curves indicated in Figure 4.7. This proves global exponential stability. Note that the level surfaces are non-convex sets, and that the system is not easily dealt with using absolute stability results due to the multi-variable nature of the nonlinearity $\text{sat}(x_1x_2)$. \square

4.8 Improving Computational Efficiency

The piecewise quadratic Lyapunov functions are much more powerful than the globally quadratic functions. As illustrated, the piecewise quadratic approach allows us to analyze many systems where other methods fail or are hard to apply. Naturally, this additional power comes at a price. System analysis using piecewise quadratic Lyapunov functions is more computationally demanding than the use of globally quadratics.

A straightforward implementation of the LMI conditions in Theorem 4.1 may result in time-consuming analysis computations. This is especially true when the state space partitioning is performed in many dimensions. It is therefore of interest to look for methods that decrease the computational burden without introducing excessive conservatism. Essentially, such savings can be done in two ways; either by reducing the number of search variables (the free variables in T , U_i and W_i), or by decreasing the number of constraints that has to be satisfied. In this section, we will provide two methods that give a significant reduction in the computations required for the piecewise quadratic analysis.

Stability Analysis in Two Steps

The LMI conditions in Theorem 4.1 incorporate the positive condition in the Lyapunov function search. At first glance, this appears very natural. Looking back at Lemma 4.4, however, we see that there is very little reason to do so. Lemma 4.4 suggests that if we can find a function which is decreasing along all system trajectories, this function contains all information about system stability. If the function can be shown to be positive definite on the partition, stability follows analogously to Theorem 4.1. If we find some point where the computed function is non-positive, then no trajectory in the partition starting at this point can approach the origin as $t \rightarrow \infty$. We give the following result.

PROPOSITION 4.4—STABILITY ANALYSIS IN TWO STEPS

Consider a symmetric matrix T , and symmetric nonnegative matrices

$U_i \succeq 0$, while $P_i = F_i^T T F_i$ for $i \in I_0$ and $\bar{P}_i = \bar{F}_i^T T \bar{F}_i$ for $i \in I_1$ satisfy

$$\begin{aligned} 0 &> A_i^T P_i + P_i A_i + E_i^T U_i E_i & i \in I_0 \\ 0 &> \bar{A}_i^T \bar{P}_i + \bar{P}_i \bar{A}_i + \bar{E}_i^T U_i \bar{E}_i & i \in I_1 \end{aligned}$$

Let $x(t) \in \cup_{i \in I} X_i$ be a trajectory of (2.3) with $u \equiv 0$ for $t \geq 0$, and define

$$V(x) = \bar{x}^T \bar{P}_i \bar{x} \quad \text{for } x \in X_i, i \in I.$$

If $V(x) > 0$ for all $x \in \cup_{i \in I} X_i \setminus \{0\}$ then every $x(t)$ tends to zero exponentially. If $V(x_0) \leq 0$ for some $x_0 \in \cup_{i \in I} X_i$ with $x_0 \neq 0$, then no $x(t)$ with $x(0) = x_0$ can tend to zero as $t \rightarrow \infty$. \square

Proof: Follows from Lemma 4.1 along the same lines as the proof of Theorem 4.1.

Proposition 4.4 implies that the large LMI problem in Theorem 4.1 can be split into several smaller problems. By disregarding the positivity constraints in the Lyapunov function search, we eliminate roughly 50% of the constraints and obtain a large reduction also in the number of search variables. Hence, this problem can be solved in a fraction of the time needed to solve the original problem. Moreover, if the LMI conditions in Proposition 4.4 do not admit a solution then neither do the analysis conditions in Theorem 4.1.

Once a Lyapunov function candidate is found we proceed to check its positivity properties. This can be done according to Lemma 4.4, similar to what was done in Theorem 4.1. Verifying positivity then amounts to solving a number of small LMI problems (one for each region). Since the Lyapunov function candidate obtained from the first step is now fixed, each such problem has only one constraint in only one free matrix variable and can be solved very efficiently. We will illustrate the savings obtained by Proposition 4.4 in the end of this section.

Quadratic Cell Boundings – Computational Savings at a Price

In many cases, it is the number of free parameters in the relaxation terms (the entries of matrices U_i and W_i) that add the most parameters to the Lyapunov function search. A second way to reduce the computations is therefore to try to minimize the number of free parameters used in the S -procedure terms. Returning to Lemma 4.4 we see that, for a given \bar{P}_i , a solution to the inequality

$$\bar{P}_i - \bar{E}_i^T U_i \bar{E}_i > 0$$

does not only imply that $V(x) = \bar{x}^T \bar{P}_i \bar{x} > 0$ for $x \in X_i$, but that $V(x)$ is positive for all x in the quadratic set

$$\mathcal{E}_i(\bar{E}_i) = \{x \mid \bar{x}^T \bar{E}_i^T U_i \bar{E}_i \bar{x} \geq 0\}.$$

We may view the term $\bar{S}_i := \bar{E}_i^T U_i \bar{E}_i$ as a description of a quadratic set derived from its polyhedral representation. From this perspective, the free parameters in U_i are used to adjust the quadratic set so as to verify the desired inequality, see Figure 4.14. One way to reduce the number of

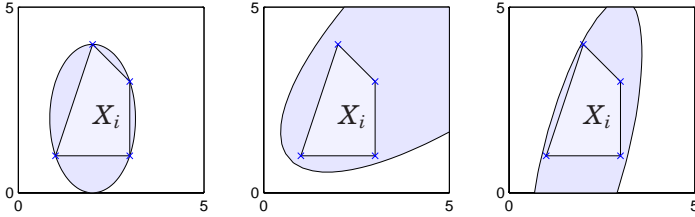

Figure 4.14 Several quadratic boundings $\mathcal{E}_i(\bar{E}_i)$ (dark) of the cell X_i (light) can be derived by optimizing the free parameters in the matrix U_i .

search variables would be to simply fix the matrix \bar{S}_i before the Lyapunov function search. This is equivalent to specifying a quadratic set

$$\mathcal{E}_i(\bar{S}_i) = \{x \mid \bar{x}^T \bar{S}_i \bar{x} \geq 0\}$$

that contains the cell X_i , i.e., $\mathcal{E}_i(\bar{S}_i) \supseteq X_i$. To pursue this direction further, we define *quadratic cell boundings* as follows.

DEFINITION 4.3—QUADRATIC CELL BOUNDING

A matrix $\bar{S}_i = \bar{S}_i^T$ is a quadratic cell bounding if

$$\bar{x}^T \bar{S}_i \bar{x} \geq 0 \quad \text{for } x(t) \in X_i. \quad (4.23)$$

Furthermore, we say that \bar{S}_i has the zero interpolation property if

$$\bar{S}_i = \begin{bmatrix} S_i & 0_{n \times 1} \\ 0_{1 \times n} & 0 \end{bmatrix} \quad \text{for } i \in I_0.$$

□

Rather than using Lemma 4.4 in the conditional analysis, we then use the following result.

LEMMA 4.5

Consider the function

$$V(x) = \bar{x}^T \bar{P}_i \bar{x} \quad \text{for } x \in X_i,$$

with $\bar{P}_i = \bar{P}_i^T$ and let \bar{S}_i be a quadratic cell bounding satisfying (4.23). If

$$\bar{P}_i - u_i \bar{S}_i > 0 \tag{4.24}$$

for some $u_i \geq 0$, then $V(x) > 0$ for all $x \in X_i$ with $x \neq 0$. □

Proof: Follows similarly to Lemma 4.4.

The following variant of Theorem 4.1 now follows directly.

PROPOSITION 4.5—PWQ STABILITY WITH QUADRATIC RELAXATION

Consider a symmetric matrix T and nonnegative scalars u_i and w_i such that $P_i = F_i^T T F_i$ for $i \in I_0$ and $\bar{P}_i = \bar{F}_i^T T \bar{F}_i$ for $i \in I_1$ satisfy

$$\begin{cases} 0 > A_i^T P_i + P_i A_i + u_i S_i \\ 0 < P_i - w_i S_i \end{cases} \quad i \in I_0$$

$$\begin{cases} 0 > \bar{A}_i^T \bar{P}_i + \bar{P}_i \bar{A}_i + u_i \bar{S}_i \\ 0 < \bar{P}_i - w_i \bar{S}_i \end{cases} \quad i \in I_1$$

Then every trajectory $x(t) \in \cup_{i \in I} X_i$ satisfying (2.3) with $u \equiv 0$ for $t \geq 0$ tends to zero exponentially. □

Proof: Follows similarly to Theorem 4.1.

Clearly, this approach allows for large savings search variables. More precisely, if $\bar{E}_i \in R^{p \times (n+1)}$, the polyhedral relaxations $\bar{E}_i^T U_i \bar{E}_i$ use $p(p-1)/2$ free parameters, while the quadratic formulation (4.23) uses just one free parameter. The drawback of this approach is that a quadratic approximation of each cell has to be fixed *before* the optimization. On the contrary, the polyhedral relaxation has a lot of freedom to adjust a quadratic supset of the region *during* the Lyapunov function search. This freedom is critical in many examples, making analysis with quadratic cell boundings fail where computations using polyhedral cell boundings verify stability.

A natural candidate for quadratic approximation of polyhedral cells is to compute the ellipsoid with minimum volume that contains the cell [44].

Further details on minimum volume ellipsoids are given in Chapter 8. Unfortunately, minimal volume has only little to do with the role of the relaxation term in the LMI conditions. Indeed, in Chapter 8 we will be able to prove that for some important classes of partitions the use of minimal volume ellipsoids is always more conservative than the formulation used in Theorem 4.1. Such a proof requires some further developments and, for now, we can only demonstrate the arguments on a simple example.

A Comparative Example

To give a flavor of the benefits and limitations of the different formulations of piecewise quadratic stability given in Theorem 4.1, Proposition 4.4 and Proposition 4.5 we consider analysis of the system shown in Figure 4.15. The system dynamics is given by

$$\dot{x} = Ax + b_1f_1(x_1) + b_2f_2(x_2)$$

where $A \in \mathbb{R}^{2 \times 2}$, $b_1, b_2 \in \mathbb{R}^{2 \times 1}$ and $f_i(x_i) = \arctan(x_i)$. We will present re-

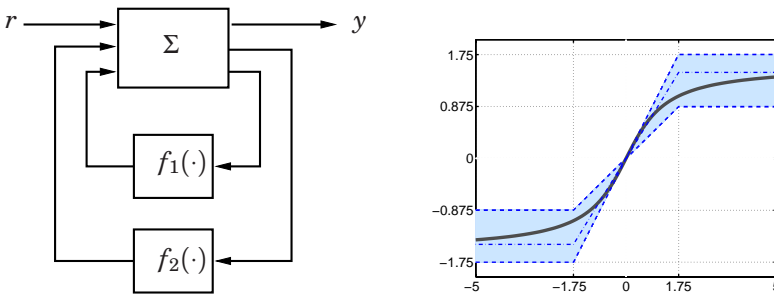

Figure 4.15 The system used as comparative example (left). The nonlinearity $f_i(x_i)$ is shown in full lines in the right figure. The dash-dotted line illustrates a piecewise linear approximation and the dashed lines show piecewise linear sector bounds.

sults for both piecewise linear approximations and piecewise linear sector bounds on the nonlinearities, see Figure 4.15 (right). In both cases, the piecewise linear descriptions induce a partition of the domain $[-5, 5] \times [-5, 5]$ into nine regions.

First, we let

$$A = \begin{bmatrix} -3 & 2 \\ 1 & -3 \end{bmatrix}, \quad b_1 = \begin{bmatrix} -1 \\ 0 \end{bmatrix}, \quad b_2 = \begin{bmatrix} 0 \\ -1 \end{bmatrix}$$

and use the piecewise linear approximation of $f_i(x_i)$. In this case, all approaches verify stability. The different computational requirements are

Approach	Time (s)	#Variables	#Constraints
P-1	1.04	117	114
P-2	0.41	69	57
Q-1	0.23	37	34
Q-2	0.11	29	17

Table 4.1 First set-up. All approaches verify stability. Large savings in computations are obtained from the alternative formulations (P-2,Q-1,Q-2).

shown in Table 4.1. The computations were performed on a SUN Ultra 10 computer using the LMI software [42]. In the table the acronym P refers to the use of polytopic cell description in the S -procedure terms while Q indicates the use of quadratic cell boundings. The number 1 means that the analysis was performed in a single step (enforcing both positivity and decreasing conditions simultaneously) while 2 means that the analysis was performed in two steps (enforcing the decreasing condition during the Lyapunov function search and subsequently verifying positivity).

As seen in Table 4.1, Proposition 4.4 (P-2) results in a large reduction in computation time compared with the computations required by Theorem 4.1(P-1). The computational savings are even greater when using quadratic cell boundings as in Proposition 4.5(Q-1). In this case, the quadratic cell boundings are taken as the minimal volume ellipsoids that cover each region. By combining the two-step analysis procedure with quadratic cell boundings (Q-2), the computational time is reduced to around than 10% of what was required by the original formulation.

Using the same matrices A , b_1 and b_2 , we now consider the case when the nonlinearities are described by piecewise linear sector bounds. This approach allows stability to be verified in a rigorous way, but it also increases the computational cost. In each region the system is now described by a differential inclusion with four extreme dynamics. As the main burden in analysis of such systems is verification of the multiple decreasing conditions, the savings of the two step analysis procedure gets somewhat lower, see Table 4.2.

The problem with ellipsoidal cell boundings is that there is very little freedom in adjusting the S -procedure terms during the Lyapunov function search. This introduces some conservatism as can be seen by letting

$$A = \begin{bmatrix} -2 & 2 \\ 1 & -2 \end{bmatrix}, \quad b_1 = \begin{bmatrix} -1 \\ 0 \end{bmatrix}, \quad b_2 = \begin{bmatrix} 0 \\ -1 \end{bmatrix},$$

and using piecewise linear sector bounds on the nonlinearities. The com-

Approach	Time (s)	#Variables	#Constraints
P-1	3.79	261	285
P-2	2.17	213	228
Q-1	0.80	61	85
Q-2	0.45	53	58

Table 4.2 Second set-up. The use of piecewise linear sector bounds decreases the benefits of the two-set analysis procedure, but good savings are still obtained.

computational results are shown in Figure 4.3. Stability can no longer be verified using ellipsoidal cell boundings, while the computational savings in the use of Proposition 4.4 remain the same.

Approach	Time (s)	#Variables	#Constraints
P-1	4.15	261	285
P-2	2.62	213	228
Q-1	fails	–	–
Q-2	fails	–	–

Table 4.3 Final set-up. Quadratic cell boundings fail to verify stability.

To understand the computational complexity of the different approaches better, it is useful to see how different factors contribute to the total number of parameters. In this example, we have constructed the constraint matrices using the procedure given in Section 8.1. This procedure gives $\bar{F}_i \in \mathbb{R}^{6 \times 3}$ and $\bar{E}_i \in \mathbb{R}^{4 \times 3}$. This implies that $T \in \mathbb{R}^{6 \times 6}$, and the Lyapunov function candidate $\bar{F}_i^T T \bar{F}_i$ has 21 free parameters. Each of the matrices U_i and W_i used in the polytopic S -procedure have 6 free parameters while the ellipsoidal S -procedure uses 1 parameter. As the origin lies in the interior of one cell, S -procedure relaxation is only used in 8 regions.

Applied to the first set-up (Table 4.1), the approach P-1 requires $21 + (1 + 1) \cdot 8 \cdot 6 = 117$ parameters while P-2 uses $21 + 1 \cdot 8 \cdot 6 = 69$ parameters. For the piecewise linear sector bounds (Table 4.2), P-1 uses $21 + (1 + 4) \cdot 8 \cdot 6 = 261$ parameters while P-2 uses $21 + 4 \cdot 8 \cdot 6 = 213$ parameters. In this case, E-2 uses only $21 + 4 \cdot 8 \cdot 1 = 53$ parameters.

4.9 Piecewise Linear Lyapunov Functions

There are several reasons to look for alternatives to the piecewise quadratic analysis. Firstly, the LMI computations in Theorem 4.1 has many free search variables, and analysis of large problems using these conditions may be time consuming using today's LMI software. Secondly, the S -procedure, which was used to exploit the restriction $x \in X_i$ in the computations, may be a restrictive way to check positivity of a piecewise quadratic function on a polyhedral domain. In other words, there are systems that admit a piecewise quadratic Lyapunov function but where this function can not be found using the search of Theorem 4.1.

As an alternative to piecewise quadratics, we will consider Lyapunov function candidates that are continuous and piecewise linear,

$$V(x) = \begin{cases} p_i^T x & x \in X_i, i \in I_0 \\ \bar{p}_i^T x = p_i^T \bar{x} + q_i & x \in X_i, i \in I_1 \end{cases} \quad (4.25)$$

Such Lyapunov functions can be computed using linear programming. Compared to LMI software, the linear programming solvers have reached a high level of maturity. Efficient software exists for large scale problems that exploits sparsity in problem data and admits systems with several thousands of cells to be analyzed in a matter of seconds.

Similar to the piecewise quadratic case, we will use a compact parameterization of such function that separates the free parameters from the constraints imposed by the continuity requirement. The parameterization is established in the following lemma.

LEMMA 4.6—PWL PARAMETERIZATION

Let $\{X_i\}_{i \in I}$ be a polyhedral partition, and let $\bar{F}_i \in \mathbb{R}^{p \times (n+1)}$ be continuity matrices that satisfy (4.14). Then, for each $t \in \mathbb{R}^p$, the scalar function

$$V(x) = t^T \bar{F}_i \bar{x} := \bar{p}_i \bar{x} \quad \text{for } x \in X_i.$$

is continuous and piecewise linear. Moreover, if each \bar{F}_i has the zero interpolation property, there exists α and β such that

$$\alpha \|x\|_\infty \leq V(x) \leq \beta \|x\|_\infty.$$

□

Proof: Follows similarly to Lemma 4.2 and the absence of offset terms in $V(x)$ in a neighborhood around the origin.

Another attractive feature of piecewise linear Lyapunov functions is that the conditional analysis ($x \in X_i$) can sometimes be performed without loss. This fact is established in the following Lemma, similar in nature to Farkas' lemma [123, 157].

LEMMA 4.7

The following statements are equivalent.

1. $p^T x > 0$ for all x such that $Ex \geq 0, Ex \neq 0$
2. There exists a vector $u > 0$ such that $p - E^T u = 0$.

□

Proof: See Section A.3.

Note that contrary to the standard formulation of Farkas' lemma which uses non-strict inequalities, Lemma 4.7 is formulated using strict inequalities. However, the result only considers linear forms, and does not treat affine terms.

The following stability theorem now follows.

THEOREM 4.3—PIECEWISE LINEAR STABILITY

Let $\{X_i\}_{i \in I} \subseteq \mathbb{R}^n$ be a polyhedral partition with continuity matrices \bar{F}_i , satisfying (4.14) and (4.15), and cell boundings $\bar{E}_i \in X_i$, satisfying (4.18) and (4.19). Assume furthermore that $\bar{E}_i \bar{x} \neq 0$ for every $x \in X_i$ such that $x \neq 0$. If there exists a vector t and non-negative vectors $u_i > 0$ and $w_i > 0$ while

$$\begin{aligned} p_i &= F_i^T t, & i \in I_0 \\ \bar{p}_i &= \bar{F}_i^T t, & i \in I_1 \end{aligned}$$

satisfy

$$\begin{cases} 0 = p_i^T A_i + u_i E_i \\ 0 = p_i^T - w_i E_i \end{cases} \quad i \in I_0 \quad (4.26)$$

$$\begin{cases} 0 = \bar{p}_i^T \bar{A}_i + u_i \bar{E}_i \\ 0 = \bar{p}_i^T - w_i \bar{E}_i \end{cases} \quad i \in I_1 \quad (4.27)$$

then every trajectory $x(t) \in \cup_{i \in I} X_i$ satisfying (2.3) with $u \equiv 0$ for $t \geq 0$ tends to zero exponentially. □

Proof: Follows similarly to Theorem 4.1 after post-multiplying the inequalities of Theorem 4.3 with x and \bar{x} respectively, and invoking Lemma 4.1 with $\|\cdot\| = \|\cdot\|_\infty$.

The search for free variables t , u_i and w_i in Theorem 4.3 is a linear programming problem. If the system does not have any attractive sliding modes, a solution to this problem guarantees that

$$V(x) = \bar{p}_i^T \bar{x} \quad \text{for } x \in X_i, i \in I$$

is a Lyapunov function for the system. The theorem is valid for both bounded and unbounded polyhedral cells. There are still relaxation terms u_i and w_i in the analysis conditions, but the number of entries in u_i and w_i has been reduced in comparison to the number of entries in the matrices U_i and W_i used in the piecewise quadratic analysis.

Note that the additional constraint

$$\bar{E}_i \bar{x} \neq 0 \quad \text{for } x \in X_i, x \neq 0$$

does not impose any further restriction. For $i \in I_0$, the assumption is violated if $\{x | \bar{E}_i \bar{x} \geq 0\}$ is some linear halfspace, but $p^T x$ can not be strictly positive for all x in a closed linear halfspace. For $i \in I_1$, the situation can always be avoided by adding the additional constraint $[0_{1 \times n} \quad 1] \bar{x} \geq 0$ to the cell bounding (as was suggested in Algorithm 4.1).

If all cells are bounded, we can exploit convexity to reduce the computations even further. More specifically, let the cells be given in vertex representation

$$X_i = \overline{\text{co}}_{k \in V(i)} \{v_k\}$$

where $V(i)$ are the set of indices for the vertices v_k of cell X_i . Then, an affine function is positive on X_i if and only if it is positive on the vertices of X_i . This allows us to formulate the following result.

THEOREM 4.4

Let $\{X_i\}_{i \in I}$ be a partition of a bounded subset of \mathbb{R}^n into convex polytopes with vertices v_k , and let \bar{F}_i be the associated continuity matrices satisfying (4.14) and (4.15). If there exists a vector t such that

$$\begin{aligned} p_i &= F_i^T t & \text{for } i \in I_0 \\ \bar{p}_i &= \bar{F}_i^T t & \text{for } i \in I \end{aligned}$$

satisfy

$$\begin{cases} 0 > p_i^T A_i v_k & i \in I_0, v_k \in X_i \\ 0 < p_i^T v_k & i \in I_0, v_k \in X_i \end{cases} \quad (4.28)$$

$$\begin{cases} 0 > \bar{p}_i^T \bar{A}_i \bar{v}_k & i \in I_1, v_k \in X_i \\ 0 < \bar{p}_i^T \bar{v}_k & i \in I_1, v_k \in X_i \end{cases} \quad (4.29)$$

for each $v_k \neq 0$, then every trajectory $x(t) \in \cup_{i \in I} X_i$ satisfying (2.3) with $u \equiv 0$ for $t \geq 0$ tends to zero exponentially. \square

Proof: Follows similarly to Theorem 4.3 but where decreasing and positivity conditions are checked according to the discussion above.

Note that all the relaxation terms have vanished, and that the vector inequalities of Theorem 4.3 have been reduced to a number of scalar inequalities.

It is possible to arrive at even simpler stability conditions if one considers partitions where each cell $X_i \subseteq \mathbb{R}^n$ has $n + 1$ vertices. Such polytopes are called simplexes, and will be treated in more detail in Section 8.1. For such partitions, the Lyapunov function is completely determined by its values at the cell vertices. The positivity conditions can then be replaced by the requirement that all entries of the vector t should be positive, $t \succ 0$.

Although Theorem 4.4 requires the analysis domain to be bounded (the cells are polytopes) it can still be used to assess global exponential stability in some cases. More precisely, if $I_1 = \emptyset$, any piecewise linear Lyapunov function valid in some open neighborhood of the origin can be used to induce a globally valid Lyapunov function. Lyapunov functions derived in this way are often called *polytopic Lyapunov functions*, as the level sets of such a Lyapunov function are polytopes, see [16, 102] for further details.

EXAMPLE 4.8—SELECTOR SYSTEM CONT'D

To illustrate the use of piecewise linear Lyapunov functions, we return to the simple min-selector system. As discussed in conjunction with Theorem 4.3, the piecewise linear Lyapunov functions cannot be used on the initial partition, since the natural cells are both open linear halfspaces. Using the refined partition shown in Figure 4.16(left), however, Theorem 4.4 return the Lyapunov function shown in Figure 4.16(right). Hence, global exponential stability follows from the arguments above. Note that the Lyapunov function is poorly conditioned, and the level surfaces are heavily unbalanced. By refining the partitioning further, one arrives at

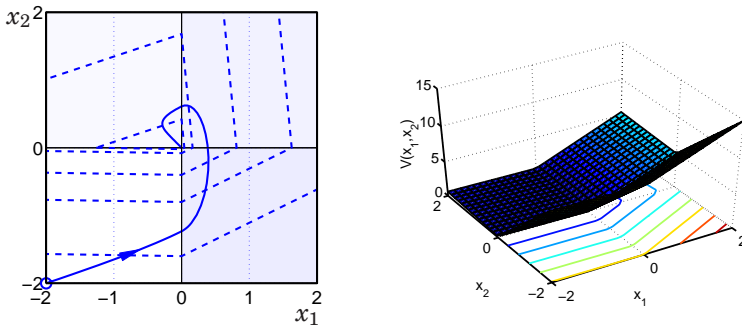

Figure 4.16 Refined partition and level surfaces of computed Lyapunov function (dashed) to the left. The computed Lyapunov function is shown to the right.

Lyapunov functions that closely resemble the Lyapunov function used in the piecewise quadratic analysis. \square

When working with piecewise linear Lyapunov functions it is often necessary to refine an initial partition in order to find a solution to the analysis problems. For example, for systems with oscillative dynamics the level sets need to be close to circular and a large number sectors may be needed to obtain the required accuracy in this approximation, see [96, 111]. It is then natural to ask how partition refinements should be made in an efficient manner. We will return to this issue in Chapter 7 and devise an automatic refinement algorithm that “introduces flexibility where needed”.

Two Useful Extensions

The basic stability computations can be extended in several useful ways. One example is computation of decay rate, τ , which can be estimated from the modified Lyapunov inequality

$$\dot{V}(x) + \tau V(x) < 0 \quad \forall x \neq 0.$$

Given a fixed value of τ , the above condition can be verified using a slight modification of the previous theorems (where A_i has been replaced by $A_i + \tau I$ in the decreasing conditions). The optimal value of τ can then be found by bisection. Another possibility is to prove stability for piecewise linear inclusions,

$$\dot{x} \in \overline{\text{co}}_{k \in K(i)} \{A_k x + \alpha_k\} \quad x \in X_i$$

In this case, one need to simultaneously solve several decreasing conditions in each region (one for each $k \in K(i)$).

4.10 A Unifying View

There is a close relation between the parameterizations of the piecewise linear and the piecewise quadratic Lyapunov functions. In this section, we will elaborate this relationship further and establish a unifying framework for computation of globally quadratic, piecewise quadratic, polyhedral and piecewise linear Lyapunov functions.

One may view the matrix format for continuous piecewise quadratic Lyapunov functions introduced in Lemma 4.2,

$$V(x) = \bar{x}^T \bar{F}_i^T T \bar{F}_i \bar{x} \quad x \in X_i,$$

as a quadratic form in the coordinates z obtained by the continuous piecewise linear mapping $z = \bar{F}_i \bar{x}$. If one rather considers linear forms in z ,

$$V(x) = t^T \bar{F}_i \bar{x} := \bar{p}_i^T \bar{x} \quad x \in X_i$$

one obtains the parameterization of continuous piecewise linear functions suggested in Lemma 4.6. In fact, the piecewise linear Lyapunov functions can be seen as a direct restriction of the piecewise quadratics as follows. Let \bar{F}_i be constraint matrices satisfying (4.14) and define

$$\hat{F}_i = \begin{bmatrix} F_i & f_i \\ 0 & 1 \end{bmatrix}, \quad T = \frac{1}{2} \begin{bmatrix} 0 & t \\ t^T & 0 \end{bmatrix}.$$

Note that \hat{F}_i also satisfies the continuity condition (4.14), and that the piecewise quadratic function $V(x)$ of Proposition 1 now evaluates to

$$\bar{x}^T \bar{P}_i \bar{x} = \bar{x}^T \hat{F}_i^T T \hat{F}_i \bar{x} = t^T \bar{F}_i \bar{x} = \bar{p}_i^T \bar{x}.$$

The close relationship between the parameterization of piecewise linear and piecewise quadratic Lyapunov functions allows us to establish a unifying view of several important approaches to numerical Lyapunov function construction, see Figure 4.17.

Most versatile are the *piecewise quadratic Lyapunov functions* [63]

$$V(x) = \bar{x}^T \bar{F}_i^T T \bar{F}_i \bar{x} \quad x \in X_i$$

As shown in Theorem 4.1, and its variants, piecewise quadratic Lyapunov functions can be computed via convex optimization in terms of LMIs. The conditional analysis (that inequalities are only required to hold for those x such that $x \in X_i$) can be done using the S-procedure, which appears to work well in practice but is only a sufficient condition.

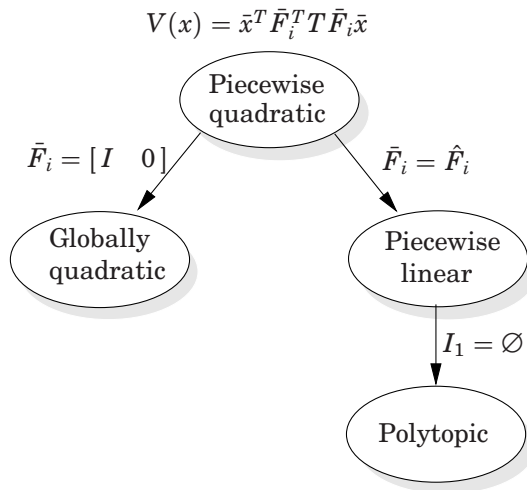

Figure 4.17 A unifying view of four classes of Lyapunov functions for piecewise linear system that can be computed via convex optimization.

The *quadratic Lyapunov functions* [33, 19] are special instances of the piecewise quadratics, obtained by letting $\bar{F}_i = [I_{n \times n} \ 0_n]$. Quadratic Lyapunov functions can be computed via LMI optimization, and conditional analysis can be done using the S -procedure.

Also the *piecewise linear Lyapunov functions* [80, 59]

$$V(x) = t^T \bar{F}_i \bar{x} \quad x \in X_i$$

can be seen as a special case of the piecewise quadratics. They can be computed via linear programming as shown in Theorem 4.3 and Theorem 4.4. The conditional analysis can in some cases be formulated without loss (as established in Lemma 4.7).

Polytopic Lyapunov functions [96, 102, 16] are a special case of the piecewise linear Lyapunov functions. The polytopic Lyapunov functions can be obtained from the piecewise linear by considering partitions that consist of convex cones with base in the origin, *i.e.*, polyhedral partitions for which $I_1 = \emptyset$. The computations can be done using linear programming and the conditional analysis is performed without loss.

Choosing Lyapunov Function Class

The choice of Lyapunov function candidate involves several trade-offs. For example, using today's technology the linear matrix inequalities in Section 3 are substantially more demanding to solve than the linear programming problems in Section 4. Well developed linear programming software

exists that allows very large problems to be solved efficiently on standard PCs. On the other hand, one may need a much finer partition when constructing a piecewise linear Lyapunov function than one would need in the case of piecewise quadratics. As always, it is advisable to try the simplest things first, and use more powerful Lyapunov function candidates only when necessary. By using one format for several classes of Lyapunov functions, it is simple to move from one function class to the other in order to find the most appropriate Lyapunov function candidate. Once the constraint matrices \bar{F}_i and \bar{E}_i for a given partition are fixed, the unifying parameterization allows seamless transfer between piecewise linear and piecewise quadratic Lyapunov function computations. To illustrate these trade-offs, we consider the following problem [104, 16]

EXAMPLE 4.9—EXPRESSIVE POWER

Consider the following linear uncertain system

$$\dot{x}(t) = A\{\delta(t)\}x(t) = \begin{bmatrix} 0 & 1 \\ -1 + \delta(t) & -1 \end{bmatrix} x(t).$$

where $|\delta(t)| \leq d$ is an uncertain time-varying parameter. For $d > \sqrt{3}/2$ there is no quadratic Lyapunov function that can show stability for all admissible parameter variations. In [16], Blanchini reported a polyhedral Lyapunov function with 30 vertices that proves stability for $d \leq 0.98$. Using a piecewise quadratic Lyapunov function with four regions (being the four quadrants in \mathbb{R}^2) we can not only decrease the number of parameters needed to represent the Lyapunov function, but also improve that bound to $d = 1 - \varepsilon$ with $\varepsilon = 1E - 15$. \square

Another issue appears when Lyapunov-like functions are used in system analysis and optimal control problems. Different problem formulations then call for different classes of loss functions. While energy-related problems (such as computation of the induced \mathcal{L}_2 -gain) are conveniently expressed as quadratic integrals, piecewise linear functions have been useful in analysis of systems with absolute constraints (see the discussion about invariant sets in Chapter 3). Related is also the question of what approaches that allow control problems to be solved using convex optimization.

4.11 Systems with Attractive Sliding Modes

The dynamics given by (2.3) are only uniquely defined in the interior of the cells, and does not suffice in case the system has attractive sliding

modes. The trajectory concept introduced in Definition 2.1 only considers functions $x(t)$ that do not remain on the cell boundary for any time interval. In case of attractive sliding modes, however, there are boundary points where all vector fields generated in the interior of the neighboring regions point towards the boundary. Trajectories in the sense of Definition 2.1 that enter the attractive sliding mode can not leave the boundary immediately, and cease to be well-defined.

Differential equations with discontinuous right-hand sides have been studied by several researchers and several definitions for solutions have been suggested. The most well-known may be the solution concepts due to Filippov [39] and Utkin [138]. Usually, solutions are defined by some limiting process, such as introducing a small hysteresis around cell boundaries and letting the hysteresis parameter tend to zero, see Figure 4.18. In this way, the behavior on the surface of discontinuity is defined by averaging the dynamics in the neighboring regions.

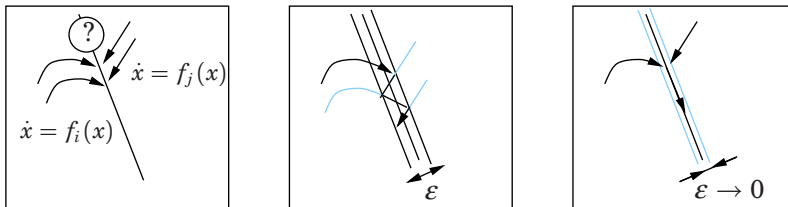

Figure 4.18 The dynamics on the surface of discontinuity is initially not well defined (left). By introducing a hysteresis layer in the cells (center) and letting its width tend to zero, a family of feasible behaviors can be obtained (right).

Filippov studied non-smooth dynamical systems

$$\dot{x} = f(x) \tag{4.30}$$

where $f : \mathbb{R}^n \rightarrow \mathbb{R}^n$ is a piecewise continuous function. The solution to this equation is understood in the following sense, see [39, 127].

DEFINITION 4.4—FILIPPOV SOLUTION

An absolutely continuous function $x(t)$ is called a solution of (4.30) on $[t_0, t_f]$ if for almost all $t \in [t_0, t_f]$

$$\dot{x} \in \bigcap_{\delta > 0} \bigcap_{\mu_N = 0} \overline{\text{co}}f(B(x, \delta) \setminus N),$$

where $\bigcap_{\mu_N = 0}$ denotes the intersection of all sets N of Lebesgue measure zero, and $B(x, \delta)$ is a ball with center in $x \in \mathbb{R}^n$ and radius δ . \square

For piecewise linear systems defined in Section 2.1, this leads to the following solution concept. An absolutely continuous function $x(t)$ is called a *Filippov solution* of the system (2.3) on $[t_0, t_f]$ if for almost all $t \in [t_0, t_f]$

$$\dot{x}(t) \in \overline{\text{co}}_{j \in J(t)} \{A_j x + a_j\}, \quad (4.31)$$

where for each t , $J(t)$ is the set of indices such that $x(t) \in X_j$.

Since the cells are assumed to have disjoint interior, the solution concept is only changed on cell boundaries. In case of attractive sliding modes, we will accept a time function $x(t)$ that remains on the cell boundary for some time interval if it can be generated by some convex combination of the dynamics in the neighboring cells.

The analysis developed up to this point is only valid for systems that do not possess attractive sliding modes. The following example shows the need to account for sliding modes in the analysis.

EXAMPLE 4.10—SLIDING MODES AND STABILITY

Consider the piecewise linear system

$$\dot{x} = \begin{cases} \begin{bmatrix} -2 & -2 \\ 4 & 1 \end{bmatrix} x := A_1 x & x_1 \geq 0 \\ \begin{bmatrix} -2 & 2 \\ -4 & 1 \end{bmatrix} x := A_2 x & x_1 \leq 0 \end{cases} \quad (4.32)$$

Both system matrices are stable and they share the same eigenvalues. Moreover, the system admits a solution to the LMIs used for the piecewise quadratic analysis of Theorem 4.1. It is easy to be misled and believe that this would imply exponential stability of the switched system (4.32). However, this is not the case, as can be seen from the Filippov solution shown in Figure 4.19. The solution tends to the attractive sliding mode $x_1 = 0, x_2 \geq 0$, along which the state vector tends to infinity. □

This example clearly demonstrates that proper treatment of sliding modes is instrumental in the analysis of general piecewise linear systems. It also illustrates how the results of Theorem 4.1 are not valid in the presence of attractive sliding modes.

Since Filippov solutions may remain on a cell boundary for some time interval, it is necessary to assure that the value of the Lyapunov function decreases also in this case. Although the Lyapunov function candidates used this far are continuous their partial derivatives do not necessarily match at cell boundaries. In order to formulate the analysis conditions,

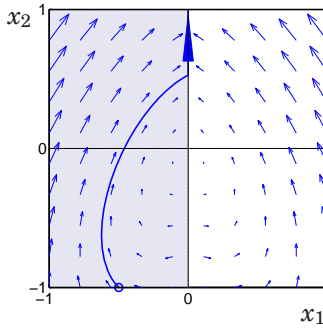

Figure 4.19 The behavior on attractive sliding modes is critical for system stability. The state reaches the sliding mode $x_1 = 0, x_2 \geq 0$, and tends to infinity.

we must therefore define an expression for the Lyapunov function on the cell boundaries. To this end, let ∂X_i be a boundary of cell X_i on which there is an attractive sliding mode, and let

$$\mathcal{J}(i) = \{j \mid X_j \cap X_i \neq \emptyset\}.$$

Let $V_i(x)$ be used to define the Lyapunov function on the cell boundary. To verify stability of Filippov solutions, we need to assure that

$$\frac{\partial V_i(x)}{\partial x} \{A_j x + a_j\} < 0 \quad \forall x \in \partial X_i \setminus \{0\}, \quad \forall j \in \mathcal{J}(i). \quad (4.33)$$

Note that any of the expressions $V_j(x)$ with $j \in \mathcal{J}$ could have been used to define the Lyapunov function on the cell boundary. However, if (4.33) can be verified for one of these expressions, continuity implies that the value $V(x)$ decreases regardless of what expression V_j is used to define the Lyapunov function on the boundary.

The condition (4.33) can also be verified via LMI computations. This allows us to use piecewise quadratic Lyapunov functions also in the analysis of systems with attractive sliding modes. To see that this, consider a sliding regime X_s defined by those x that satisfy

$$\begin{aligned} \bar{G}_i^{(s)} \bar{x} &= 0 \\ \bar{G}_i^{(n)} \bar{x} &\geq 0 \end{aligned}$$

To guarantee that the Lyapunov function is decreasing with respect to all extreme dynamics in

$$\dot{x} \in \overline{\text{co}}_{j \in G(t)} \{A_j x + a_j\}$$

we augment the analysis conditions of Theorem 4.1 by the following LMI conditions.

$$\bar{A}_j^T \bar{P}_i + \bar{P}_i \bar{A}_j + \left(\bar{G}_i^{(n)} \right)^T W_{ij} \bar{G}_i^{(n)} + \left(\bar{G}_i^{(s)} \right)^T N_{ij} + N_{ij}^T \bar{G}_i^{(s)} < 0$$

for matrices $W_{ij} \succeq 0$ and N_{ij} of appropriate dimensions.

Sliding mode analysis gives a significant increase in the computations required to assess stability. If sliding modes can be ruled out a priori one should therefore use the theorems that are tailored to this situation. If sliding modes cannot be ruled out, it is preferable to try to detect on what boundaries sliding modes will occur and use the augmented conditions only on these surfaces. This can be done using the tools in Section 3.4. Apart from decreasing the computational burden, information of where sliding modes appear gives valuable engineering insight.

EXAMPLE 4.11—EXPONENTIAL STABILITY OF SLIDING MODE SYSTEM

To illustrate stability analysis of a system with sliding modes, we consider the following slight modification of Example 4.10

$$\dot{x} = \begin{cases} A_1 x & x_2 \geq 0 \\ A_2 x & x_2 \leq 0 \end{cases}$$

where A_1 and A_2 are the system matrices defined in Example 4.10. Also this system has an attractive sliding mode, as illustrated by the simulation in Figure 4.20. Applying the extended stability analysis described above, we find a piecewise quadratic Lyapunov function that guarantees stability also on the sliding mode. State trajectories and the corresponding value of the Lyapunov function are shown in Figure 4.20.

□

The same approach used above extends directly to piecewise linear Lyapunov functions.

4.12 Local Analysis and Convergence to a Set

In many cases a local stability analysis cannot be extended globally. The following example illustrates an interesting case when the piecewise quadratic analysis according to Theorem 4.1 fails.

EXAMPLE 4.12—LYAPUNOV ANALYSIS OF SATURATED SYSTEM

Consider again the double integrator under bounded linear feedback.

$$\begin{aligned} \dot{x}_1 &= x_2 \\ \dot{x}_2 &= -\text{sat}(2x_1 + 3x_2) \end{aligned}$$

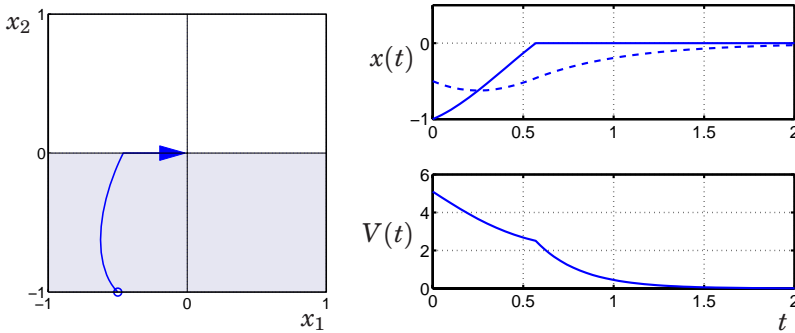

Figure 4.20 The extended stability conditions verify stability also in the presence of attractive sliding modes. The computed Lyapunov function decreases also on the attractive sliding mode (right).

It can be verified that the function

$$V(x_1, x_2) = \frac{1}{2}x_1^2 + \frac{1}{2} \int_0^{2x_1+3x_2} \text{sat}(z) dz \quad (4.34)$$

is a Lyapunov function that proves global asymptotic stability of the origin. However, the convergence is not exponential in the saturated regions and the Lyapunov function candidate cannot be bounded in the sense of Lemma 4.1 (the Lyapunov function grows quadratically in the x_1 -direction, but only linearly in the x_2 -direction). Hence, there is no solution to the LMIs of Theorem 4.1. \square

When the local stability analysis cannot be extended globally, one may still hope to achieve a larger guaranteed region of attraction than the one resulting from a purely linear analysis (such as that of Proposition 4.1).

A simple way to extend the local analysis is to try to verify the stability conditions within some ball $\mathcal{B}_R = \{x \mid x^T x \leq R^2\}$. By gradually increasing the radius, one increases the domain of validity of the analysis, and hopefully also the resulting domain of attraction. Let

$$\bar{\mathcal{B}}_R = \begin{bmatrix} -I & 0 \\ 0 & R^2 \end{bmatrix}. \quad (4.35)$$

Then, the ball \mathcal{B}_R can be expressed as

$$\mathcal{B}_R = \{x \mid \bar{x}^T \bar{\mathcal{B}}_R \bar{x} \geq 0\}$$

Stability analysis can then be carried out by adding the relaxation term $u_i \bar{\mathcal{B}}_R$ to the LMI conditions of Theorem 4.1. The decreasing conditions

then take the form

$$0 > \bar{A}_i^T \bar{P}_i + \bar{P}_i \bar{A}_i + \bar{E}_i^T U_i \bar{E}_i + u_i \bar{B}_R.$$

for $u_i \geq 0$. These extensions can be used to obtain significantly better estimates of the region of attraction for the saturated system than what can be obtained from Proposition 4.1.

EXAMPLE 4.13—EXTENDED ROA ESTIMATION FOR SATURATED SYSTEM

By gradually increasing the analysis radius R , exponential stability can be established for a ball of very large radius (in the order of $R = 1E4$). The level surfaces of the computed Lyapunov function are shown in Figure 4.21.

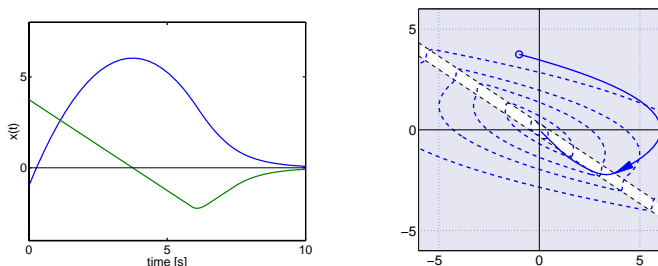

Figure 4.21 Although the system trajectories do not have uniform global exponential decay in the saturated regions (left), it is still possible to find a piecewise quadratic Lyapunov function that stability for a very large set of initial values.

□

The intuition about this example is that although the required Lyapunov function cannot be bounded by quadratic functions globally it can be bounded by quadratics on any compact domain. Numerical precision limits how far the analysis domain can be extended.

A more interesting case is when the open loop system is unstable. The bounded control will then give a bounded domain of attraction. The following example shows how the approach described above can be used for estimating the region of attraction.

EXAMPLE 4.14—BOUNDED REGION OF ATTRACTION

By replacing the double integrator system by

$$\begin{aligned} \dot{x}_1 &= x_2 \\ \dot{x}_2 &= 0.1x_2 - \text{sat}(2x_1 + 3x_2) \end{aligned}$$

we obtain a system which is exponentially unstable. This system can not be globally stabilized using a bounded feedback. Using the approach described above we can still obtain an estimate of the region of attraction, as shown in dashed line in Figure 4.22. For comparison, the exact region of attraction obtained by simulation is shown in full line in the same figure.

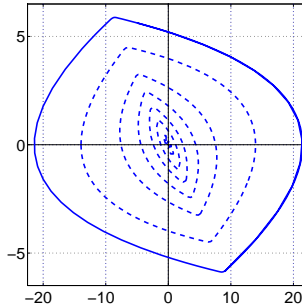

Figure 4.22 Limited region of attraction estimated by piecewise quadratic Lyapunov function (dashed), and exact region of attraction (full).

□

Note that a similar approach could be used to show convergence to a set. By restricting the analysis to the region outside some ball $\mathcal{B}_r = \{x \mid x^T x \leq r^2\}$, convergence be established to the largest level set of the computed Lyapunov function that contains \mathcal{B}_r . Such a result could be combined with the local instability analysis to do limit cycle computations.

4.13 Comments and References

Piecewise Quadratic Lyapunov Functions

When quadratic Lyapunov functions do not suffice, it is very natural to consider functions that are piecewise quadratic. We have for example seen how the Lyapunov functions used in the Popov criterion are piecewise quadratic when the nonlinearity in the feedback connection is piecewise linear. It has been pointed out to us that the idea of “patching together” piecewise quadratic Lyapunov functions in the state space has been used in the analysis of specific nonlinear systems, see [116].

To the best of our knowledge, this thesis is the first work that presents a systematic methodology for computation of piecewise quadratic Lyapunov functions. The focus on piecewise linear systems and the use of

convex optimization are two important ingredients that allow complex systems to be analyzed using efficient numerical computations. Around the same time that these results were published [63], similar ideas were reported for the analysis of hybrid systems in [109]. An interesting extension to systems with multiple equilibrium points was given in [44].

Strict vs. Nonstrict Inequalities

As the main benefit of the stability conditions presented in this thesis is the possibility for numerical verification, our philosophy has been to derive stability conditions that can be implemented in software as they stand. This has led to two peculiarities in our formulation of the stability conditions.

The first feature is the separation of cells that contain the origin from cells that do not. From a theoretical point-of-view it may appear unnecessary to eliminate affine terms in regions that contain the origin. An alternative approach would be to use non-strict inequalities

$$\bar{A}_i^T \bar{P}_i + \bar{P}_i \bar{A}_i + \bar{E}_i^T U_i \bar{E}_i \leq \begin{bmatrix} -\varepsilon I & 0 \\ 0 & 0 \end{bmatrix} \quad \forall i \in I.$$

A formulation of this kind could be useful for analysis of systems with multiple equilibria [44]. However, at the writing of this thesis neither [42] which was used for all computations in this thesis, nor the freely available semidefinite programming environment [151] supported non-strict LMIs.

Another feature of the stability conditions is that they use a parameterization that enforces continuity on the Lyapunov function candidate. An alternative approach would simply be to have different matrices \bar{P}_i in each region, and then enforce continuity via constraint equations of the type (4.13). This is the approach used in [108, 44]. There are many factors that contributed to our use of constraint matrices. Not every optimization environment supports the mixture of linear equations and LMI conditions. It may also be numerically sensitive to introduce a large number of superfluous parameters, and then trust the optimization software to eliminate redundant constraints. Moreover, the approach with constraint matrices is natural for many classes of partitions (as will be shown in Chapter 8), and can be used with ease also for complicated partitions.

Piecewise Linear Lyapunov Functions

While efficient software for LMI optimization have not appeared until quite recently [100], the simplex method for solving linear programming problems is more than 50 years old [35]. Consequently, researchers have for a long time been aware of the benefits of deriving results that can be verified via linear programming.

Computer algorithms for construction of piecewise linear Lyapunov functions have been reported in, among others, [24, 25, 95, 16, 96, 102]. The focus has been on polytopic Lyapunov functions and uncertain linear systems. An important exception is the work [102] that considers polytopic Lyapunov functions for piecewise linear systems. Highly related to our approach is the stability analysis proposed in [80], in which piecewise linear Lyapunov functions (that may have affine terms, and are not necessarily polytopic) were constructed using so-called facet functions.

Polytopic vs. Ellipsoidal Cell Boundings

Ellipsoidal cell boundings have also been used in the references [108, 44]. In [44], ellipsoidal cell boundings were used to allow the use of the S-procedure in control design based on quadratic Lyapunov functions. In [108], ellipsoidal cell boundings were used to assure robustness to uncertainties in regional descriptions of hybrid systems. As shown in this chapter, computational efficiency may be another reason for trying ellipsoidal cell boundings before using the full power of polyhedral relaxation terms.

Numerical Lyapunov Function Construction

Most analysis methods for dynamical systems are somehow related to Lyapunov functions, and a Lyapunov function appears more or less explicitly in most analysis conditions. Dissipativity analysis [149, 47], absolute stability [152, 113], and analysis based on integral quadratic constraints [94] can all be viewed as methods for Lyapunov function construction.

5

Dissipativity Analysis

A fundamental idea in systems and control is to view complex systems as the interconnection of simpler subsystems. Such a perspective is often helpful in bringing insight into and understanding about a dynamic system. Viewing a system as the interconnection of its components, it is natural to ask whether the analysis of a complex system can be based on the (hopefully simpler) analysis of its components. This is the idea behind input-output analysis, which has been a very successful tool in system theory. Roughly speaking, the idea is to replace detailed models of system components by relationships between their input and output energies, and then derive results for interconnections of such models. The most well-known results may be the small-gain and the passivity theorems. Both allow stability of a feedback interconnection to be verified from the analysis of its components. Hence, by establishing \mathcal{L}_2 -gain or passivity properties of piecewise linear systems, we can hope to establish stability of interconnections by invoking small gain and passivity theorems. This chapter will provide such tools.

This approach is useful for robustness analysis and it also allows us to use different tools for analyzing different components. For example, physical insight may help us to establish passivity of one subsystem and piecewise linear techniques can allow us to prove strict passivity of another subsystem. This allows us to analyze systems that combine piecewise linear systems with components that can not be or are not efficiently described by piecewise linear techniques. Time delays is one example of such components.

As we have seen in Chapter 2, several important interconnections of piecewise linear systems are themselves piecewise linear. Although this route will not be explored in depth here, we note that these tools will also allow us to choose whether to analyze a interconnected system in one step, or to first analyze the subsystems and then use small-gain and passivity results. This will enable us to trade-off complexity in the computations

for some conservatism in the analysis.

5.1 Dissipativity Analysis via Convex Optimization

Dissipativity is a very useful notion in the study of performance and robustness of dynamical systems. Roughly speaking, dissipativity means that the system absorbs more energy from its environment than it supplies. In a more abstract setting a dissipative system is defined as a system that admits a supply rate (defining “input power”) and a storage function (measuring the “stored energy”) so that the energy is always dissipated, see [149, 47]. Many important system properties, such as \mathcal{L}_2 -induced norms and passivity, correspond to different supply rates.

There is a close relation between Lyapunov functions and storage functions. In some cases the storage function will qualify as a Lyapunov function, hence proving system stability. Moreover, for linear systems with quadratic supply rates it can be shown that dissipativity implies the existence of a quadratic storage function [149]. With the developments from the previous chapter at hand, it is natural to base a dissipativity analysis of piecewise linear systems on storage functions that are piecewise quadratic. Before giving some precise results, we will illustrate the ideas on the problem of estimating the \mathcal{L}_2 -norm of a piecewise linear system. The initial step will be based on a simple and transparent Lyapunov technique, see [149, 47, 140].

Performance Bounds from Dissipation Inequalities

Consider the problem of estimating an upper bound on the \mathcal{L}_2 -induced gain from u to y of the system (2.3). In other words, we want to determine a constant γ such that

$$\int_0^T \|y(t)\|_2^2 dt \leq \gamma^2 \int_0^T \|u(t)\|_2^2 dt \quad \forall u(t)$$

holds for all $T \geq 0$. We will assume that $x(0) = 0$. The inequality can be verified if we can find a non-negative storage function $V(x) \geq 0$ with $V(x(0)) = 0$ such that

$$\frac{\partial V}{\partial x} (A_i x + a_i + B_i u) \leq \gamma^2 u^T u - y^T y \quad (5.1)$$

along system trajectories. Integration of this inequality gives

$$V(x(t)) - V(x(0)) \leq \gamma^2 \int_0^T \|u(t)\|_2^2 dt - \int_0^T \|y(t)\|_2^2 dt.$$

Since $V(x(0)) = 0$ and $V(x) \geq 0$, we have

$$0 \leq \gamma^2 \int_0^T \|u(t)\|_2^2 dt - \int_0^T \|y(t)\|_2^2 dt.$$

and the desired bound follows.

As always with Lyapunov-techniques, the central difficulty lies in finding a storage function $V(x)$ that satisfies the dissipation inequality. We will consider systems that are piecewise linear and storage functions that are piecewise quadratic. This will allow us to compute estimates on the \mathcal{L}_2 -gain using convex optimization. For a given partition, a best upper bound can then be obtained by minimizing the parameter γ subject to the relevant inequalities. Also this problem is convex.

For linear systems, it is sufficient to consider quadratic storage functions, and the exact \mathcal{L}_2 -gain can be found using the above procedure [19]. A similar result for piecewise linear systems is, to the best of the author's knowledge, unknown. In general, the above computations will return bounds on γ rather than the exact \mathcal{L}_2 -gain.

Dual Bounds from Worst Case Disturbances

Working with bounds rather than exact solutions, it is useful to have measures on how good the computed bounds are. For the dissipativity-like computations in this chapter, such bounds can often be obtained by constructing “worst-case disturbances”. As the optimal value of γ can be obtained from the solution of the Hamilton-Jacobi-Bellman equation

$$\frac{\partial V(x)}{\partial x} (A_i x + a_i + B_i u) = \gamma u^T u - y^T y,$$

it is natural to try to construct a worst case disturbance that attains equality in (5.1). Let $\hat{V}(x)$ be a solution to (5.1) and let $\hat{\gamma}$ be the gain estimate obtained in this way. A lower bound on the \mathcal{L}_2 -induced gain can then be obtained by maximizing the expression

$$\frac{\partial \hat{V}(x)}{\partial x} (A_i x + a_i + B_i u) + y^T y - \hat{\gamma}^2 u^T u$$

with respect to u . Simulating the piecewise linear system with this input and comparing the input and output norms then gives a lower bound on the \mathcal{L}_2 -induced gain. As this estimate is based on piecewise quadratic storage functions rather than arbitrary storage functions the maximization will only give a lower bound on the \mathcal{L}_2 -induced gain.

Successive Refinements via Upper and Lower Bounds

In many cases, the bounds obtained by piecewise quadratic computations will give significant improvements compared to computations based on quadratic storage functions. Moreover, by making refinements of the state-space partitioning, it is possible to introduce more flexibility in the piecewise quadratic storage functions. With increased flexibility, the computations can be repeated in hope of achieving better estimates. As increased flexibility comes at the price of increased computations, the upper and lower bounds can serve as an aid in the trade-off between precision in the analysis and the cost of computations.

5.2 Computation of \mathcal{L}_2 -induced Gain

The analysis outlined above can be directly combined with the developments in Chapter 4 to give LMI conditions for \mathcal{L}_2 gain computations for piecewise linear systems. After verification of stability, for example using Theorem 4.1, an upper bound for the gain can be obtained as follows.

THEOREM 5.1—UPPER BOUND ON \mathcal{L}_2 GAIN

Suppose there exist symmetric matrices T , U_i and W_i such that U_i and W_i have non-negative entries, while $P_i = F_i^T T F_i$ and $\bar{P}_i = \bar{F}_i^T T \bar{F}_i$ satisfy

$$\begin{aligned} 0 &> \begin{bmatrix} P_i A_i + A_i^T P_i + C_i^T C_i + E_i^T U_i E_i & P_i B_i \\ B_i^T P_i & -\gamma^2 I \end{bmatrix} && \text{for } i \in I_0 \\ 0 &> \begin{bmatrix} \bar{P}_i \bar{A}_i + \bar{A}_i^T \bar{P}_i + \bar{C}_i^T \bar{C}_i + \bar{E}_i^T U_i \bar{E}_i & \bar{P}_i \bar{B}_i \\ \bar{B}_i^T \bar{P}_i & -\gamma^2 I \end{bmatrix} && \text{for } i \in I_1 \end{aligned}$$

Then every trajectory $x(t)$ with $x(0) = 0$, $\int_0^\infty (\|x\|_2^2 + \|u\|_2^2) dt < \infty$ satisfies

$$\int_0^\infty \|y\|_2^2 dt \leq \gamma^2 \int_0^\infty \|u\|_2^2 dt.$$

The best upper bound on the \mathcal{L}_2 induced gain is achieved by minimizing γ subject to the constraints defined by the inequalities. \square

Proof: Let $i(t)$ be chosen so that $x(t) \in X_i$, and let $\bar{P}_i = [I \ 0]^T P_i [I \ 0]$ for $i \in I_0$. It then follows from the matrix inequalities in Theorem 5.1 that

$$0 \geq \begin{bmatrix} \bar{P}_i \bar{A}_i + \bar{A}_i^T \bar{P}_i + \bar{C}_i^T \bar{C}_i + \bar{E}_i^T U_i \bar{E}_i & \bar{P}_i \bar{B}_i \\ \bar{B}_i^T \bar{P}_i & -\gamma^2 I \end{bmatrix} \quad \forall i \in I.$$

Multiplying from the left and right with $[\bar{x}^T \quad u]$ and removing the non-negative terms $\bar{x}^T \bar{E}_i^T U_i \bar{E}_i \bar{x}$ gives

$$\begin{aligned} 0 &\geq 2\bar{x}^T \bar{P}_i (\bar{A}_i \bar{x} + \bar{B}_i u) + \bar{x}^T \bar{C}_i^T \bar{C}_i \bar{x} - \gamma^2 u^T u = \\ &= \frac{d}{dt} (\bar{x}^T \bar{P}_i \bar{x}) + \|y\|_2^2 - \gamma^2 \|u\|_2^2 \end{aligned}$$

Integration from 0 to ∞ gives the desired inequality.

In analogy with the previous section, a lower bound on the gain can be computed by the construction of a worst case disturbance. For this purpose, we will consider disturbances on the form $u = \bar{L}_i \bar{x}$, where the “feedback gains” L_i are obtained by maximizing the expression

$$2\bar{x}^T \bar{P}_i (\bar{A}_i \bar{x} + \bar{B}_i u) + \|\bar{C}_i \bar{x}\|_2^2 - \hat{\gamma}^2 \|u\|_2^2$$

with respect to u . The precise formulas for the “feedback gains” will be given in the next chapter and are omitted here. In the above expression, \bar{P}_i and $\hat{\gamma}$ come from the upper bound computation. Simulating the system with this control law and comparing the input and output norms gives a lower bound on the \mathcal{L}_2 gain.

EXAMPLE 5.1—ANALYSIS OF A SATURATED CONTROL SYSTEM

Consider the control system shown in Figure 5.1. The output of the system $G_1(s)$ is subject to a unit saturation. The closed loop dynamics is piecewise affine, with three cells induced by the saturation limits $u = \pm 1$. We set

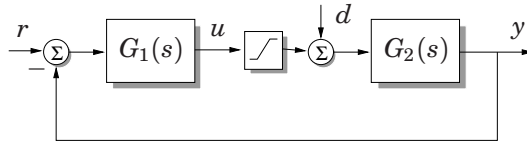

Figure 5.1 Saturated control system.

$r = 0$ and estimate the \mathcal{L}_2 -induced gain from the disturbance d to the output y . With the transfer functions

$$G_1(s) = \frac{s-3}{16s^2+s+2} \quad G_2(s) = \frac{s+7}{4s^2+3s+12}$$

we obtain the results shown in Table 5.1.

Here “Lure function” means a Lyapunov function of the form $V(x) = x^T P x + \eta \int_0^{Cx} \text{sat}(s) ds$ and “IQC for monotonic nonlinearities” means a

Method	Gain Estimate
Quadratic Lyapunov function	No solution found
Lure function with positive η	No solution found
Lure without constraints on η	37.63
IQC for monotonic nonlinearities	5.62
Piecewise quadratic Lyapunov function	5.54

Table 5.1 Various upper bounds on \mathcal{L}_2 gain.

gain estimate computed based on [155] using the toolbox [93]. A lower bound on the \mathcal{L}_2 gain, computed for the linear region, is equal to 5.52. \square

This example is somewhat contrived, but it illustrates the differences that can be obtained from the various approaches. Apart from being useful in analysis of disturbance rejection properties, computation of \mathcal{L}_2 -induced gain can be used for establishing robust stability in presence of norm-bounded uncertainties. We will return to this in an example in the end of this chapter.

5.3 Estimation of Transient Energy

In order to demonstrate the use of partition refinements, we will apply the central idea to the estimation of the “transient energy”

$$\int_0^\infty \bar{x}^T \bar{Q}_i \bar{x} dt \quad \text{for } x(t) \in X_i, \quad i \in I$$

of a piecewise linear system. This can be seen as an alternative to simulation. The value of this integral depends on the initial value and we would like our estimate to also be a function of the initial value. In this way, one computation will give an estimate of the integral for every initial value on the partition. We assume that $\bar{Q}_i = \bar{Q}_i^T$ have the zero interpolation property, *i.e.*

$$\bar{x}^T \bar{Q}_i \bar{x} = \bar{x}^T \begin{bmatrix} Q_i & 0 \\ 0 & 0 \end{bmatrix} \bar{x} = x^T Q_i x \quad \text{for } i \in I_0$$

The desired estimates can be obtained from the following minor modification of the stability analysis in Chapter 4.

THEOREM 5.2—UPPER BOUND ON TRANSIENT ENERGY

Let $x(t) \in \cup_{i \in I} X_i$ with $x(\infty) = 0$ be a trajectory of the system (2.3) with $u \equiv 0$ for $t \geq 0$. Consider symmetric matrices T and U_i , such that U_i have non-negative entries, while $P_i = F_i^T T F_i$ and $\bar{P}_i = \bar{F}_i^T T \bar{F}_i$ satisfy

$$\begin{aligned} 0 &> P_i A_i + A_i^T P_i + Q_i + E_i^T U_i E_i & i \in I_0, \\ 0 &> \bar{P}_i \bar{A}_i + \bar{A}_i^T \bar{P}_i + \bar{Q}_i + \bar{E}_i^T U_i \bar{E}_i & i \in I_1. \end{aligned}$$

Then

$$\int_0^\infty \bar{x}^T \bar{Q}_i \bar{x} dt \leq \inf_{T, U_i} \bar{x}(0)^T \bar{P}_{i_0} \bar{x}(0).$$

□

Proof: It follows directly from the two inequalities that

$$0 \geq \bar{P}_i \bar{A}_i + \bar{A}_i^T \bar{P}_i + \bar{Q}_i + \bar{E}_i^T U_i \bar{E}_i, \quad i \in I.$$

Let $i(t)$ be chosen so that $x(t) \in X_{i(t)}$. Then, multiplying the above inequality from left and right by \bar{x} and removing nonnegative terms gives

$$0 \geq \frac{d}{dt} (\bar{x}^T \bar{P}_{i(t)} \bar{x}) + \bar{x}(t)^T \bar{Q}_{i(t)} \bar{x}(t).$$

Integration from $t = 0$ to $t = \infty$ gives the desired result.

A lower bound can be obtained similarly, by replacing \bar{Q}_i by $-\bar{Q}_i$ in the analysis. A solution to the resulting inequalities then implies that

$$\bar{x}(0)^T \bar{P}_{i_0} \bar{x}(0) \leq \int_0^\infty \bar{x}^T \bar{Q}_i \bar{x} dt.$$

A best lower bound estimated in this way can be obtained by maximizing $V(x_0)$ subject to the relevant constraints.

Note that although the computations are optimized for a specific initial value, the function $V(x)$ obtained from the computations bounds the value of the integral for all initial values on the partition.

In many cases, $\bar{Q}_i \geq 0$ for all $i \in I$. A solution to the LMIs of Theorem 5.2 then guarantees that there is a solution to the inequalities in Proposition 4.4. Hence, if the function $V(x) = \bar{x}^T \bar{P}_i \bar{x}$ obtained from the computations above is positive on the partition, then it will also work as a Lyapunov function for the system.

The following example applies the results on the problem of estimating the “output energy” for a piecewise linear system and illustrates the use of partition refinements to obtain better and better estimates.

EXAMPLE 5.2—TRANSIENT IN FLOWER EXAMPLE

Consider again the piecewise linear system defined in Example 4.3, and introduce an output $y = x_1$, *i.e.*, let

$$C_i = [1 \ 0], \quad i \in I.$$

Figure 5.2 shows a simulated trajectory (left) and the corresponding output (right). Consider the problem of estimating the “output energy”,

$$\int_0^\infty \|y(t)\|_2^2 dt = \int_0^\infty x(t)^T C_i^T C_i x(t) dt$$

from a given initial value. This can be done by direct application of Theorem 5.2 by letting $Q_i = C_i^T C_i$. The output simulated from $x(0) = [1 \ 0]$ (shown in Figure 5.2) has total energy $\int_0^\infty \|y(t)\|_2^2 dt = 1.88$, while the bounds obtained from Theorem 5.2 for the initial cell partition gives $0.60 \leq \int_0^\infty \|y\|_2^2 dt \leq 2.50$.

A possible reason for the gap between the bounds is that the level curves of the cost function can not be well approximated by piecewise quadratic functions. To improve the bounds, we introduce more flexibility in the approximation by repeatedly splitting every cell in two. This simple-minded refinement procedure, illustrated in Figure 5.3, is repeated three times yielding the bounds shown in Table 5.2.

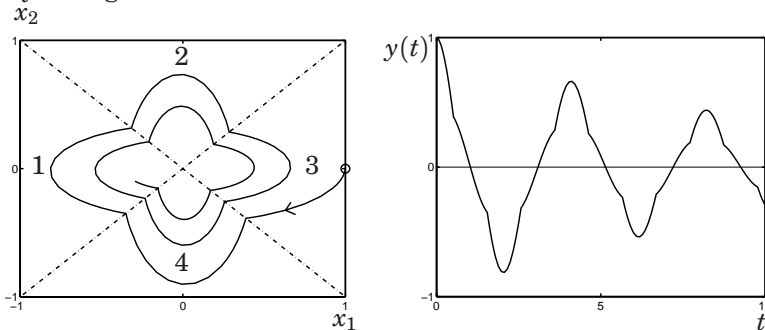

Figure 5.2 Trajectory of a simulation (left) and corresponding output (right).

Note that the bounds on the output energy optimized for the initial state $(1, 0)$ match closely over the the whole state space, giving good estimates of the output energy also for other initial states. \square

5.4 Dissipative Systems with Quadratic Supply Rates

The results of the previous sections can be generalized in a natural way to validation of more general dissipation inequalities. The same technique

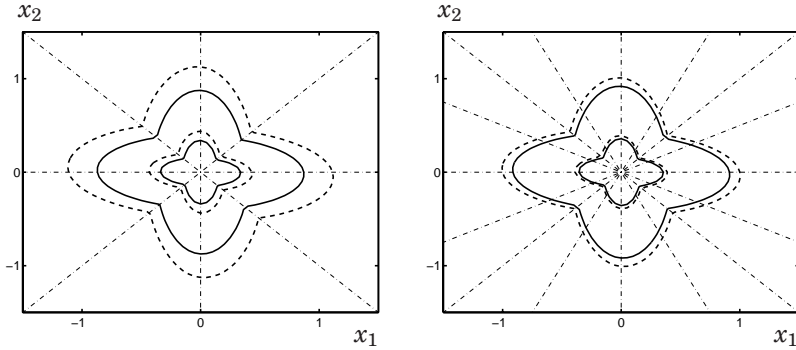

Figure 5.3 Upper (full) and lower (dashed) bounds on the storage function computed in Example 5.2. The bounds get increasingly tight when we move from 8 cells (left) to 16 cells (right).

Number of Cells	Lower bound	Upper bound
4	0.60	2.50
8	1.33	2.18
16	1.65	1.98
32	1.78	1.88

Table 5.2 Lower and upper bounds for output energy obtained by application of Theorem 5.2.

that was used in \mathcal{L}_2 -induced gain computations can be applied to verification of dissipativity with respect to arbitrary quadratic supply functions. We give the following result.

THEOREM 5.3—VALIDATION OF DISSIPATION INEQUALITIES

Consider symmetric matrices T , U_i and W_i such that U_i and W_i have non-negative entries, while $P_i = F_i^T T F_i$ and $\bar{P}_i = \bar{F}_i^T T \bar{F}_i$ satisfy

$$\begin{cases} 0 < \begin{bmatrix} C_i & D_i \\ 0 & I \end{bmatrix}^T M \begin{bmatrix} C_i & D_i \\ 0 & I \end{bmatrix} - \begin{bmatrix} P_i A_i + A_i^T P_i + E_i^T U_i E_i & P_i B_i \\ B_i^T P_i & 0 \end{bmatrix} \\ 0 < P_i - E_i^T U_i E_i \end{cases}$$

for $i \in I_0$ and

$$\begin{cases} 0 < \begin{bmatrix} \bar{C}_i & \bar{D}_i \\ 0 & I \end{bmatrix}^T M \begin{bmatrix} \bar{C}_i & \bar{D}_i \\ 0 & I \end{bmatrix} - \begin{bmatrix} \bar{P}_i \bar{A}_i + \bar{A}_i^T \bar{P}_i + \bar{E}_i^T U_i \bar{E}_i & \bar{P}_i \bar{B}_i \\ \bar{B}_i^T \bar{P}_i & 0 \end{bmatrix} \\ 0 < \bar{P}_i - \bar{E}_i^T U_i \bar{E}_i. \end{cases}$$

for $i \in I_1$. Then every trajectory $x(t)$ with $x(0) = 0$ and $\int_0^t \|u(t)\|_2^2 dt < \infty$ satisfies

$$0 \leq \int_0^t \begin{bmatrix} y(s) \\ u(s) \end{bmatrix}^T M \begin{bmatrix} y(s) \\ u(s) \end{bmatrix} ds \quad \forall t \geq 0$$

□

Proof: Multiplying from left and right by (\bar{x}, u) gives

$$0 \leq \begin{bmatrix} y \\ u \end{bmatrix}^T M \begin{bmatrix} y \\ u \end{bmatrix} - \frac{d}{dt} (\bar{x}^T \bar{P}_i \bar{x})$$

and the result follows by integration over $[0, t]$.

The \mathcal{L}_2 -induced gain computations given in Theorem 5.1 are a special case of this result, where

$$M = \begin{bmatrix} -I & 0 \\ 0 & \gamma^2 \end{bmatrix}.$$

In this way, Theorem 5.3 can be used to establish induced gain and passivity properties of piecewise linear systems that can be used in analysis based on the small gain or passivity theorems. This type of results open up many possibilities, as they allow freedom in whether to incorporate nonlinearities in the system description or to replace them by energy inequalities and use interconnection results. They also allow analysis of robustness with respect to dynamic uncertainties. The following example illustrates some of the ideas.

EXAMPLE 5.3—ROBUSTNESS ANALYSIS VIA THE SMALL GAIN THEOREM

Consider the system shown in Figure 5.4. This is a linear system with a dynamic uncertainty Δ and a nonlinear spring. The uncertainty block Δ is assumed to have induced \mathcal{L}_2 -gain less than one and the spring has the nonlinear characteristic shown in Figure 5.4. Nonlinear spring arrangements of similar type can for example be found in engine control systems, see [81]. We set $u = 0$ and consider the system defined by a transfer matrix $G(s)$ with state-space realization

$$\frac{d}{dt} \begin{bmatrix} x_1 \\ x_2 \\ x_3 \end{bmatrix} = \begin{bmatrix} -3 & 0 & -1 \\ 4 & -1 & 0 \\ 0 & 2 & -1 \end{bmatrix} \begin{bmatrix} x_1 \\ x_2 \\ x_3 \end{bmatrix} + \begin{bmatrix} 0 & -5 \\ 0 & 0 \\ 1 & 0 \end{bmatrix} \begin{bmatrix} w_d \\ w_s \end{bmatrix}$$

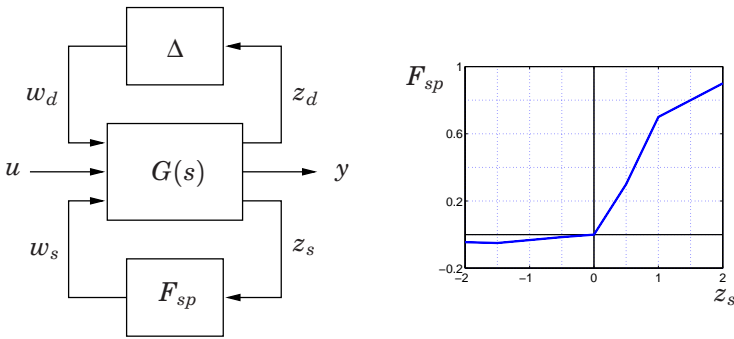

Figure 5.4 System with nonlinear spring characteristic and unmodeled dynamics (left). Detailed spring characteristic (right).

and outputs $z_d = x_1$, $z_s = x_2$.

The tools derived so far give a large flexibility in how to analyze stability of this system. A first crude approximation is to use a norm bounds on both the Δ -block and on the spring characteristic, and then apply the small gain theorem [78]. However, this approach fails for the suggested example, as the H_∞ norm of the linear system exceeds one (the H_∞ -norm is 5.73). Another approach is to consider the feedback interconnection of the linear system and the spring as a piecewise linear system, and treat only the Δ -block as uncertain. We may then start by using global sector bounds on the spring nonlinearity and estimate the \mathcal{L}_2 -gain from w_d to z_d (see Figure 2.6). However, this approach estimates the \mathcal{L}_2 -gain to 1.12 and stability can not be established. Using the piecewise linear sector bounds in Figure 2.6(middle) and applying Theorem 5.1 verifies that the gain from w_d to z_d is less than 0.25 and closed loop stability follows. \square

This example demonstrates how induced \mathcal{L}_2 -gain computations can be used to robustness analysis of piecewise linear uncertain systems, and how partition refinements are useful for obtaining sufficient accuracy in the analysis.

5.5 Comments and References

Piecewise Linear Systems and Integral Quadratic Constraints

The verification of dissipation inequalities could easily be extended to treat more general integral quadratic constraints (IQCs). For example, integral quadratic constraints with a frequency dependent weight rather

than a constant matrix M could be verified using Theorem 5.3 by first introducing a state space realization of the weight, and then include this dynamics in the system description. Once a certain integral quadratic constraint has been verified for a piecewise linear component, it can be used in the general framework for IQC-based system analysis developed in [94]. A more straightforward approach would be to perform IQC-based analysis directly in the piecewise linear framework. The analysis of piecewise linear systems interconnected with components described by IQCs could potentially be very useful. A good starting point for a stability analysis based on piecewise quadratic Lyapunov functions could be the Lyapunov approach outlined in [70], Section 1.7.

Nonlinear H_∞ Control

Interpreted in time domain, the linear H_∞ problem is concerned with attenuation of the \mathcal{L}_2 -induced gain from disturbances to outputs. Nonlinear H_∞ refers to the extensions of these techniques to nonlinear systems, see [53]. In this context, \mathcal{L}_2 -induced gains are often estimated using finite difference discretization of the dissipation inequalities, see [54].

6

Controller Design

The ultimate aim of any work on control theory is to provide methods and procedures for controller design. Up until this point, we have focused on deriving methods for stability and performance analysis of piecewise linear systems. At the very least, such methods can be used in control design procedures that iterate between design and analysis steps.

In this chapter, we will proceed by applying the piecewise quadratic machinery to design of optimal feedback controls for piecewise linear systems. More precisely, we will consider optimal control problems with piecewise quadratic costs. Such control laws can be derived from the solution to the associated Hamilton-Jacobi-Bellman equation. By considering Hamilton-Jacobi-Bellman *inequalities* rather than equations, we will show how piecewise quadratic functions and convex optimization can be used to obtain lower bounds on the optimal cost. Based on this solution, a piecewise linear feedback law is derived that tries to achieve this cost. In this way, convex optimization can be used to design sub-optimal feedback solutions to control problems with quadratic cost functions. By refining the partitioning of the state space, more flexibility can be introduced when solving the relevant matrix inequalities, in hope of achieving increasingly better solutions and control laws with improved performance.

As an alternative, we will consider formulations that allow design problems to be solved by direct optimization. Using this approach, however, we will discover that it is not so easy to use piecewise quadratic functions as the basis for control design while keeping convexity in the computations. We will present some cases when convexity can be retained, and discuss alternatives when this fails.

6.1 Piecewise Linear Quadratic Control

Consider the following general form of optimal control problem.

$$\begin{aligned} & \text{Minimize} && \int_0^\infty L(x, u) dt \\ & \text{subject to} && \begin{cases} \dot{x}(t) = f(x(t), u(t)) \\ x(0) = x_0 \end{cases} \end{aligned}$$

It is well known that solutions of this problem can be characterized in terms of the Hamilton—Jacobi—Bellman (H-J-B) equation

$$0 = \inf_u \left(\frac{\partial V}{\partial x} f(x, u) + L(x, u) \right). \quad (6.1)$$

In fact, by integrating the inequality

$$0 \leq \frac{\partial V}{\partial x} f(x, u) + L(x, u) \quad \forall x, u \quad (6.2)$$

and assuming that $x(\infty) = 0$, we get

$$V(x_0) - V(0) = - \int_0^\infty \frac{\partial V}{\partial x} f(x, u) dt \leq \int_0^\infty L(x, u) dt.$$

Hence, every V that satisfies (6.2) gives a lower bound on the optimal value of the loss function. In fact, the maximization of $V(x_0) - V(0)$ subject to (6.2) is a convex optimization problem in V with an infinite number of constraints parameterized by x and u . The objective of this section is to solve this problem in some special cases.

Let us consider the case where f is piecewise linear and L is piecewise quadratic. Then, the objective is to bring the system to $x(\infty) = 0$ from an arbitrary initial state $x(0)$, while limiting the cost

$$J(x_0, u) = \int_0^\infty (\bar{x}^T \bar{Q}_i \bar{x} + u^T R_i u) dt.$$

Here $i(t)$ is defined so that $x(t) \in X_{i(t)}$. Under the assumption that

$$\bar{Q}_i = \begin{bmatrix} Q_i & 0 \\ 0 & 0 \end{bmatrix} \quad \text{for } i \in I_0 \quad (6.3)$$

this can be done in analogy with the previous results as follows.

THEOREM 6.1—LOWER BOUND ON OPTIMAL COST

Assume existence of symmetric matrices T and U_i , such that U_i have non-negative entries, while $P_i = F_i^T T F_i$ and $\bar{P}_i = \bar{F}_i^T T \bar{F}_i$ satisfy

$$0 < \begin{bmatrix} P_i A_i + A_i^T P_i + Q_i - E_i^T U_i E_i & P_i B_i \\ B_i^T P_i & R_i \end{bmatrix} \quad i \in I_0$$

$$0 < \begin{bmatrix} \bar{P}_i \bar{A}_i + \bar{A}_i^T \bar{P}_i + \bar{Q}_i - \bar{E}_i^T U_i \bar{E}_i & \bar{P}_i \bar{B}_i \\ \bar{B}_i^T \bar{P}_i & R_i \end{bmatrix} \quad i \in I_1$$

Then, every trajectory $x(t)$ of (2.3) with $x(t) \in \cup_{i \in I} X_i$, $x(\infty) = 0$ and $x(0) = x_0 \in X_{i_0}$ satisfies

$$J(x_0, u) \geq \sup_{T, U_i} \bar{x}_0^T \bar{P}_{i_0} \bar{x}_0$$

□

Proof: It follows directly from the matrix inequalities in Theorem 6.1 that

$$0 \leq \begin{bmatrix} \bar{P}_i \bar{A}_i + \bar{A}_i^T \bar{P}_i + \bar{Q}_i - \bar{E}_i^T U_i \bar{E}_i & \bar{P}_i \bar{B}_i \\ \bar{B}_i^T \bar{P}_i & R_i \end{bmatrix} \quad i \in I$$

Multiplying from left and right by (\bar{x}, u) and removing the nonnegative terms including U_i gives

$$\begin{aligned} 0 &\leq 2\bar{x}^T \bar{P}_i (\bar{A}_i \bar{x} + \bar{B}_i u) + \bar{x}^T \bar{Q}_i \bar{x} + u^T R_i u \\ &= \frac{d}{dt} (\bar{x}^T \bar{P}_i \bar{x}) + \bar{x}^T \bar{Q}_i \bar{x} + u^T R_i u \end{aligned}$$

Integration from 0 to ∞ gives the desired result.

Note that it is straightforward to modify Theorem 6.1 for the case of input constraints of the form

$$G_i x + H_i u \geq 0 \text{ for } i \in I_0 \quad \bar{G}_i \bar{x} + \bar{H}_i u \geq 0 \text{ for } i \in I$$

The first inequality condition then becomes

$$0 < \begin{bmatrix} P_i A_i + A_i^T P_i + Q_i & P_i B_i \\ B_i^T P_i & R_i \end{bmatrix} - \begin{bmatrix} E_i & 0 \\ G_i & H_i \end{bmatrix}^T U_i \begin{bmatrix} E_i & 0 \\ G_i & H_i \end{bmatrix}$$

and the second is analogous.

Theorem 6.1 gives a lower bound on the minimal value of the cost function J . Upper bounds are obtained by studying specific control laws. Consider the control law obtained by the minimization

$$\min_u \left(\frac{\partial V}{\partial x} f(x, u) + L(x, u) \right). \quad (6.4)$$

If the H-J-B equation (6.1) holds, then every minimizing control law is optimal. In particular, V has then decay rate given by $-L(x, u)$, which is typically negative, so V may serve as a Lyapunov function to prove that the control law is stabilizing.

However, if only the inequality (6.2) holds, for example as a result of solving the matrix inequalities in Theorem 6.1, then there is no guarantee that the control law minimizing (6.4) is even stabilizing. Still, the minimization problem is the starting point for definition of control laws that will be used in our further analysis.

Exact minimization of the expression (6.4) without input constraints can be done analytically in analogy with ordinary linear quadratic control, using the notation

$$\begin{aligned} L_i &= -R_i^{-1} B_i^T P_i, & \bar{L}_i &= -R_i^{-1} \bar{B}_i^T \bar{P}_i, \\ \mathcal{A}_i &= A_i + B_i L_i, & \bar{\mathcal{A}}_i &= \bar{A}_i + \bar{B}_i \bar{L}_i, \\ Q_i &= Q_i + P_i B_i R_i^{-1} B_i^T P_i, & \bar{Q}_i &= \bar{Q}_i + \bar{P}_i \bar{B}_i R_i^{-1} \bar{B}_i^T \bar{P}_i. \end{aligned} \quad (6.5)$$

The minimizing control law can then be written as

$$u(t) = \bar{L}_i \bar{x} \quad x \in X_i.$$

This control law is simple, but may be discontinuous and give rise to sliding modes. For simplex partitions, to be described in detail later, this problem can be avoided as follows. First design control vectors u_i for the grid points of the partition, then use linear interpolation between these vectors to define affine state feedback laws $u = \bar{L}_i \bar{x}$ inside the simplexes. In this way, no sliding modes are created and the design approach can also be used in the case of input constraints.

Once a stabilizing piecewise linear control law has been designed, an upper bound of the optimal cost is obtained from Theorem 5.2. We give the following example.

EXAMPLE 6.1—LQ CONTROL OF AN INVERTED PENDULUM

Consider the following simple model of an inverted pendulum

$$\begin{aligned} \dot{x}_1 &= x_2 \\ \dot{x}_2 &= -0.1x_2 + \sin(x_1) + u \end{aligned} \quad (6.6)$$

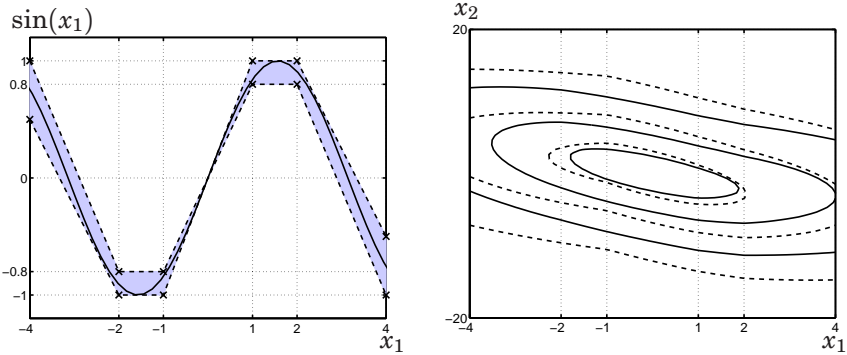

Figure 6.1 The left figure shows bounds on the system nonlinearity. The right figure shows lower (dashed) and upper (solid) bounds on the optimal cost.

We are interested in applying the proposed technique to find a feedback control that brings the pendulum from rest at the stable equilibrium $(\pi, 0)^T$ to the upright position $(0, 0)^T$ while minimizing the criteria

$$J(x, u) = \int_{t=0}^{\infty} 4x_1^2(t) + 4x_2(t)^2 + u^2 dt.$$

A piecewise linear model of the system (6.6) can be constructed by finding piecewise affine bounds on the system nonlinearity $\sin(x_1)$. For the purpose of this example, we divide the interval $[-4, 4]$ into five segments and compute the bounds illustrated in Figure 6.1 (left). This description of the system nonlinearity induces the partition shown by dotted vertical lines in Figure 6.1 (right). We apply Theorem 6.1 to compute a lower bound on the achievable performance as $J(x_0, u) \geq 15.2$.

It is easy to verify that the closed loop system obtained by applying the control law (6.5) is stable and has no attractive sliding modes. Theorem 5.2 can now be applied to compute the upper bound on the performance to be $J(x_0, u) \leq 16.6$. We conclude that both the optimal and the computed control law satisfy

$$15.2 \leq J(x_0, u) \leq 16.6.$$

The level surfaces of the upper and lower bounds on the value function is shown in Figure 6.1 (right). Although the bounds are valid for all initial values within the estimated region of attraction, they match most closely for the optimized initial value. In addition, the computed control law is evaluated on the pendulum model (6.6) by simulation. The value of the loss function computed in this way is $J(x_0, u) = 15.4$. \square

6.2 Comments and References

Optimal Control and the Hamilton-Jacobi-Bellman Inequality

By considering optimal control problems in terms of Hamilton-Jacobi-Bellman inequalities rather than equations, it has been possible to use convex optimization in the design of optimal control laws. Interesting theoretical results on the H-J-B inequality can be found [146]. The H-J-B inequality has also been used to obtain computational procedures for solving optimal control problems with discrete states [13].

Although the ideas of using convex optimization for design of optimal controllers has only been taken a very short step in this thesis, the approach appears to have a large potential. It has allowed us to obtain feedback solutions from optimal control considerations using very simple methods.

Piecewise Linear Quadratic Control

Work related to the term piecewise linear quadratic control has appeared in [9, 150]. In [9], linear quadratic control problems for piecewise linear systems were addressed by solving Riccati differential equations, and the optimum had to be recomputed for each new final state. The reference [150] treats control design for linear systems with bounded controls. A piecewise linear control law is obtained by scheduling a set of state feedback controllers designed via linear quadratic theory.

Failure of an Elegant Trick

An attractive feature of quadratic stability analysis via linear differential inclusions is that control design problems also can be solved via convex optimization. An elegant trick which makes it possible to formulate the joint search for Lyapunov function and state feedback gains as a convex optimization problem is given in [12, 19]. Unfortunately, a straightforward application of the same trick to the analysis conditions for piecewise quadratic Lyapunov functions fails.

Consider a linear system $\dot{x} = Ax + Bu$. Assume that we want to design a linear state feedback $u = Kx$ that renders the closed loop system

$$\dot{x} = Ax + BKx$$

exponentially stable. Verifying exponential stability amounts to finding a quadratic Lyapunov function $V(x) = x^T Px$ for the closed loop system. Hence, the design of a stabilizing controller can be formulated as the

existence of K and P that satisfy the matrix inequalities

$$P > 0$$

$$A^T P + PA + K^T B^T P + PBK < 0$$

At a first glance this problem appears to be non-convex, since products of the matrix variables P and K appear in the conditions. However, convexity can be recovered by the change of variables

$$Q = P^{-1}, \quad Y^T = KQ^T$$

Pre-and post-multiplication of the design inequalities by Q gives

$$Q > 0$$

$$QA^T + AQ + YB^T + BY^T < 0$$

which are LMI conditions in the variables Q and Y .

Unfortunately, the same trick does not work directly in the case of piecewise quadratic Lyapunov functions, and convexity is not easily recovered. The joint search for a piecewise linear feedback law $u = \bar{K}_i \bar{x}$ and a piecewise quadratic Lyapunov function gives the matrix inequalities

$$\bar{P}_i - \bar{E}_i^T U_i \bar{E}_i > 0$$

$$\bar{A}_i^T \bar{P}_i + \bar{P}_i \bar{A}_i + \bar{K}_i^T \bar{B}_i^T \bar{P}_i + \bar{P}_i \bar{B}_i \bar{K}_i + \bar{E}_i^T W_i \bar{E}_i < 0$$

There are now three obstacles to a direct application of the trick used in quadratic stability analysis. Whereas the condition $P > 0$ guarantees that P is invertible, a similar claim is not automatically true for the piecewise quadratic case. Even if we assume invertability, it is not easy to find a parameterization of the inverse of the matrices

$$P_i = F_i^T T F_i$$

that parameterize continuous piecewise quadratics. Moreover, the presence of S -procedure terms, which are typically sign indefinite, is a further obstacle.

Three Ideas on How to Proceed

One possibility for recovering convexity in the joint feedback and Lyapunov function search is to find a format for matrices whose inverses parameterize continuous and piecewise quadratic functions.

$$\bar{F}_i^T T \bar{F}_i$$

Such a parameterization is possible for the special case when all cells of the partition are simplexes. By restricting the parameter matrix T to be diagonal, and by computing the constraint matrices as suggested in Section 8.1, it is possible to obtain an explicit format for the inverse as

$$P^{-1} = V_i T^{-1} V_i^T.$$

However, the class of Lyapunov functions obtained in this way appears to be very weak, and it is hard to obtain solutions to the associated optimization problem. Whether there is a more powerful format for these matrices remains an open question and such a format would potentially be very useful. Two interesting references in this context are [44, 16]. In the first reference it is shown how it is possible to use quadratic cell boundings in LMI-based controller design using quadratic Lyapunov functions. The second reference deals with controller design for polytopic Lyapunov functions.

A second approach would of course be to fix a Lyapunov function and only consider the problem of finding feedback gains. This approach gives convex design problems, and is natural when invariance properties and state constraints are part of the design specifications, see [154].

A final way out is to accept that the design inequalities are bilinear in the relevant matrix variables, and to apply non-convex optimization methods for solving these. As software for solving these problems continue to develop [137], this may be an increasingly interesting alternative. We note that in this framework, it is easy to restrict the feedback laws to be continuous which is natural in many cases.

7

Extensions

The piecewise linear analysis can be extended in many useful ways. This chapter presents four extensions of the basic results. The first extension is to show how fuzzy systems can be viewed as piecewise linear differential inclusions, hence be analyzed using piecewise quadratic Lyapunov functions. This allows an important class of fuzzy control systems to be analyzed using substantially more powerful methods than was previously available. The second extension considers a class of piecewise linear hybrid systems. Piecewise linear systems with hysteresis components are a special case. In the analysis of such systems, it is advantageous to employ piecewise quadratic Lyapunov functions that have certain discontinuities. It is shown how the search for such Lyapunov functions can be formulated in the LMI framework, allowing a class of hybrid systems to be analyzed using efficient computations. A third development is to consider analysis of smooth nonlinear systems. By taking approximation errors explicitly into account, it is shown how rigorous analysis results for smooth systems can be obtained from the piecewise linear analysis. In order to achieve sufficient accuracy in the nonlinearity description and required flexibility in the Lyapunov function candidate, it is often necessary to refine an initial partition. It then becomes natural to ask how such partition refinements can be made automatically and efficiently. The fourth development is to devise a simple method for automatic partition refinements. The refinements are based on linear programming duality, and try to improve flexibility where it is needed the most.

7.1 Fuzzy Logic Systems

While fuzzy control systems have quickly gained acceptance in industry, a large part of academia is still approaching works on fuzzy control with suspicion. One reason for this is the evident lack of systematic methods for analysis and design of fuzzy control systems. In this section, we will

illustrate how the piecewise linear techniques developed in the previous chapters can be applied to the analysis of fuzzy control systems.

Recently, an increasing amount of work in fuzzy systems literature has been devoted to analysis of linear Takagi-Sugeno systems [134]. The behavior of these systems are described by a set of rules R_i on the form

$$\begin{aligned} R_i : \quad & \text{IF } x_1 \text{ is } F_{i,1} \text{ AND } \dots \text{ AND } x_n \text{ is } F_{i,n} \\ & \text{THEN } \dot{x} = A_i x, \end{aligned} \quad i = 1, \dots, L. \quad (7.1)$$

Normally, the sets $F_{i,k}$ (describing the k th input variable in the i th rule) are labeled using linguistically meaningful terms such as “Large”, “Fast” or “Saturated”. Contrary to classical logic, where a proposition such as “ x_k is $F_{i,k}$ ” can only take the values 0 or 1, fuzzy logic allows propositions to be fulfilled to any degree in the interval $[0, 1]$. To support this, one introduces membership functions

$$\mu_{i,k}(x) : \mathbb{R}^n \rightarrow [0, 1],$$

that to each x assigns a degree of validity of the proposition “ x is $F_{i,k}$ ”. Using extensions of the inference and compositional rules of classical logic, fuzzy logic can derive a value of \dot{x} for a given x based on linguistic rules on the form (7.1). In this way, fuzzy systems allows dynamic models to be specified by a set of linguistic rules, the associated membership functions and some fuzzy inference parameters (see [3] for further details).

By the appropriate restrictions of the fuzzy inference parameters [134, 135, 147], the dynamics derived from the rules (7.1) can be written as

$$\dot{x} = \sum_{i=1}^L \mu_i(x) \cdot A_i x. \quad (7.2)$$

Here, $\mu_i(x)$ are normalized membership functions obtained as

$$\begin{cases} \tilde{\mu}_i(x) = \prod_{k=1}^n \mu_{i,k}(x) \\ \mu_i(x) = \frac{\tilde{\mu}_i(x)}{\sum_{i=1}^L \tilde{\mu}_i(x)} \end{cases} \quad (7.3)$$

Hence $\mu_i(x)$ satisfy $0 \leq \mu_i(x) \leq 1$, $\sum_i \mu_i(x) = 1$.

Drawing upon the work on quadratic stability and quadratic stabilization, this formulation has been used as a basis for solve stability analysis, gain computations and state feedback design problems for fuzzy systems

using LMI computations, see [156, 135]. Unfortunately, most of these results are derived by embedding the fuzzy system (7.2) into the class of linear time-varying systems

$$\dot{x} = \sum_{i=1}^L \lambda_i(t) A_i x \quad (7.4)$$

where the weights $\lambda_i(t)$ may vary arbitrarily with time while satisfying $0 \leq \lambda_i(t) \leq 1$, $\sum_i \lambda_i(t) = 1$. In other words, the stability conditions guarantee stability for the system (7.4) from which stability of (7.2) follows. By this embedding, the structural information structural information about the system encoded in the rule premises is disregarded. As we have seen in Chapter 4, this structural information is crucial in many cases.

It is natural to try to extend the piecewise quadratic analysis to fuzzy systems. In this way, fuzzy controllers can be analyzed efficiently using more powerful Lyapunov functions and structural information can be accounted for. This also allow us to treat affine Takagi-Sugeno systems that have an additional offset term in the consequent dynamics. This was the model structure that what was originally proposed in [134]. The affine Takagi-Sugeno systems are described by rules on the form

$$\begin{aligned} R_i : \quad & \text{IF } x_1 \text{ is } F_{i,1} \text{ AND } \dots \text{ AND } x_n \text{ is } F_{i,n} \\ & \text{THEN } \dot{x} = A_i x + a_i, \quad i = 1, \dots, L \end{aligned}$$

and the inferred dynamics can be written as

$$\dot{x} = \sum_{i=1}^L \mu_i(x) \cdot \{A_i x + a_i\}, \quad (7.5)$$

with $\mu_i(x) \geq 0$ and $\sum_i \mu_i(x) = 1$. Many applications use affine Takagi-Sugeno systems, see e.g. [132, 7]. As shown in [37], the function approximation capabilities of the Takagi-Sugeno system are also substantially improved when offset terms are allowed.

Takagi-Sugeno Fuzzy Systems – A Piecewise Linear Perspective

In order to clarify the link between fuzzy systems and the piecewise linear systems considered in this thesis, it is fruitful to consider fuzzy systems as a particular instance of operating regime based models [56, 97]. Operating regime based modeling is a common name for techniques where a globally valid model of the system dynamics is obtained by combining simple local models, each valid within a certain operating regime. In this

context, the special feature of fuzzy systems is that prior knowledge of operating regimes and locally valid dynamics is encoded using fuzzy rules. Each rule antecedent defines an operating regime and the associated rule consequent specifies the local model valid within this region:

$$R_i : \underbrace{\text{IF } x_1 \text{ is } F_{i,1} \text{ AND } \dots \text{ AND } x_n \text{ is } F_{i,n}}_{\text{operating regime specification}} \\ \text{THEN } \underbrace{\dot{x} = A_i x + a_i}_{\text{local dynamics}}, \quad i = 1, \dots, L$$

Comparing with the mathematical description (7.5), we see that in regions where $\mu_i(x) = 1$ for some i , all other normalized membership functions evaluate to zero and the dynamics of the system is given by $\dot{x} = A_i x + a_i$. We will call such a region the *operating regime* of model i . Between operating regimes there are regions where $0 < \mu_i(x) < 1$. In these regions, the system dynamics is given by a convex combination of several affine systems. We will call these regions *interpolation regimes*. As we will see next, the partitioning into operating and interpolation regimes is often polyhedral. This will allow us to view fuzzy systems as pwLDIs and directly apply the associated analysis techniques to fuzzy systems.

The Geometry of Fuzzy Partitions

There is more structure in fuzzy system partitions than what is directly visible in the formulation (7.5). Consider for simplicity the case when the model scheduling is governed by one variable, $w = Cx$. In this case, the rules are on the form

$$R_i : \text{IF } w \text{ is } F_i \text{ THEN } \dot{x} = A_i x + a_i \quad i = 1, \dots, L. \quad (7.6)$$

The operating regimes where $\mu_i(w) = 1$ induce intervals in the scheduling space $w = Cx$, and polyhedral cells in the state space. An example of membership functions and the associated partitioning is shown in Figure 7.1. Note that if the scheduling intervals $\{w | \mu_i(w) = 1\}$ are connected sets, the induced regimes are convex polyhedral sets. This is for example the case for the membership functions in Figure 7.1.

A similar structure in the induced partition can be found when rules are formed using the AND connective in a higher dimensional scheduling space. The rules then take the form (7.1), and the normalized membership functions are obtained as in (7.3). Since $\mu_l(x) = 1$ in operating regime l , we must have $\mu_{l,m}(x_m) = 1$ for $m = 1, \dots, n$. Operating regime l is thus given by the intersection of the cells that are induced by the fuzzy sets

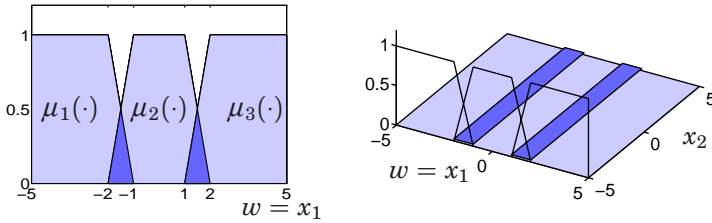

Figure 7.1 The normalized membership functions (left) and the resulting partition of the state space into operating and interpolation regimes (right).

used in each propositional variable,

$$X_l = \bigcap_m \{x : \mu_{l,m}(x_m) = 1\}.$$

The partition resulting from rules formed with the AND connective can be seen as a composition of several simple partitions, as illustrated in Figure 7.2. Moreover, the induced operating and interpolation regimes are then convex polyhedral sets that can be obtained directly from the membership functions of the simple propositions.

Fuzzy Systems as Piecewise Linear Differential Inclusions

The discussion above establishes that affine Takagi-Sugeno systems can be viewed as pwLDIs as introduced in Chapter 2. The fuzzy rules (7.1) induce a partitioning of the state space into a number of convex polyhedral cells $\{X_i\}_{i \in I}$. The cells act either as operating regimes or as interpolation regimes. In each region, the dynamics is given by a convex combination of affine systems

$$\dot{x} = \sum_{k \in K(i)} \mu_k(x) \{A_k x + a_k\}, \quad x \in X_i$$

with $0 \leq \mu_k(x) \leq 1$, $\sum_{k \in K(i)} \mu_k(x) = 1$. Here, we have introduced the index set $K(i)$ to specify what system matrices are used in the interpolation within cell X_i , *i.e.*,

$$K(i) = \{k \mid \mu_k(x) > 0 \text{ for } x \in X_i\}$$

For operating regimes, the set $K(i)$ contains one single element. By disregarding the state dependence of the membership functions, we can embed

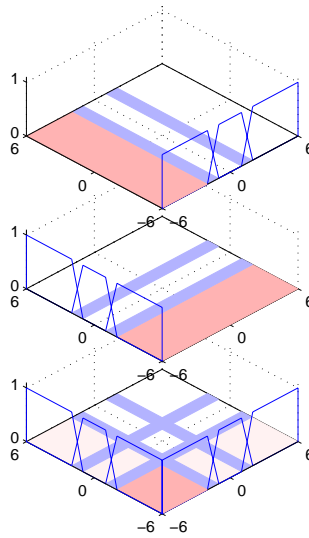

Figure 7.2 The fuzzy partition with scheduling in two variables (bottom) can be derived from the intersection of simple partitions induced by each propositional variable (top and center).

these fuzzy systems into the class of pwLDIs,

$$\dot{x} = \overline{\text{co}}_{k \in K(i)} \{ \bar{A}_k \bar{x} \} \quad x \in X_i \quad (7.7)$$

with $0 \leq \mu_k(t) \leq 1$, $\sum_{k \in K(i)} \mu_k(t) = 1$. Now, Theorem 4.2 applies directly and gives a novel procedure for studying stability of fuzzy systems.

An Example

In order to demonstrate the feasibility of the approach to problems of more realistic size, this section presents a piecewise quadratic stability analysis of a 25-region fuzzy system. The system dynamics is given by the nine rules in Table 7.1. The membership functions of the fuzzy propositions “ x_i is $F_{i,i}$ ” are trapezoidal and shown in Figure 7.1. The rules partition the state space into the operating regimes and interpolation regimes shown in Figure 7.3.

Note that all regions off the origin have bias terms, and that the system matrices associated to some of the operating regions are non-Hurwitz (these operating regimes, given by the two last rules of the rule base, are lightly shaded in Figure 7.3). Hence, the standard conditions for quadratic stability can not be applied. As shown in Figure 7.4, simulations reveal a highly nonlinear behavior but suggest that the system is stable.

IF	x_1 is negative	AND	x_2 is positive	THEN	$\dot{x} = A_1x + a_1$
IF	x_1 is zero	AND	x_2 is positive	THEN	$\dot{x} = A_2x + a_2$
IF	x_1 is positive	AND	x_2 is positive	THEN	$\dot{x} = A_3x + a_3$
IF	x_1 is negative	AND	x_2 is zero	THEN	$\dot{x} = A_4x + a_4$
IF	x_1 is zero	AND	x_2 is zero	THEN	$\dot{x} = A_5x + a_5$
IF	x_1 is positive	AND	x_2 is zero	THEN	$\dot{x} = A_6x + a_6$
IF	x_1 is negative	AND	x_2 is negative	THEN	$\dot{x} = A_7x + a_7$
IF	x_1 is zero	AND	x_2 is negative	THEN	$\dot{x} = A_8x + a_8$
IF	x_1 is positive	AND	x_2 is negative	THEN	$\dot{x} = A_9x + a_9$

Table 7.1 Rule base for 25 region fuzzy system.

The linear matrix inequalities of Theorem 4.2 have a feasible solution proving exponential stability of the origin. The level surfaces of the computed Lyapunov function are indicated by dashed lines in Figure 7.5. Note that the rules only describe the system dynamics on the domain $\|x\|_\infty \leq 5$. Hence, stability can only be granted for trajectories that do not escape from this region. We conclude local asymptotic stability of the origin, with a guaranteed region of attraction indicated by the outermost level set in Figure 7.5.

7.2 Hybrid Systems

Hybrid systems are systems that combine continuous dynamics and discrete events. Hybrid control systems arise when there is an interaction between logic-based devices and continuous dynamics and control.

The piecewise linear systems considered so far can indeed be regarded as hybrid systems. The cell index may be viewed as a discrete state variable whose value changes when the continuous state hits a cell boundary. Arguably, the discrete state has a very passive role in this case and this model class can exhibit very few behaviors that can not be understood from a classical nonlinear systems perspective [78]. For a broad review of hybrid phenomena and associated models, see [23]. In this section, we will extend the piecewise quadratic analysis to a class of systems with a more prominent hybrid nature. In relation to the systems considered so far, we can view this hybrid extension as piecewise linear systems that have overlapping regimes in \mathbb{R}^n . The value of the discrete state is no longer determined directly by the partition, but has to be specified via a set of transition rules. Piecewise linear systems with hysteresis components will

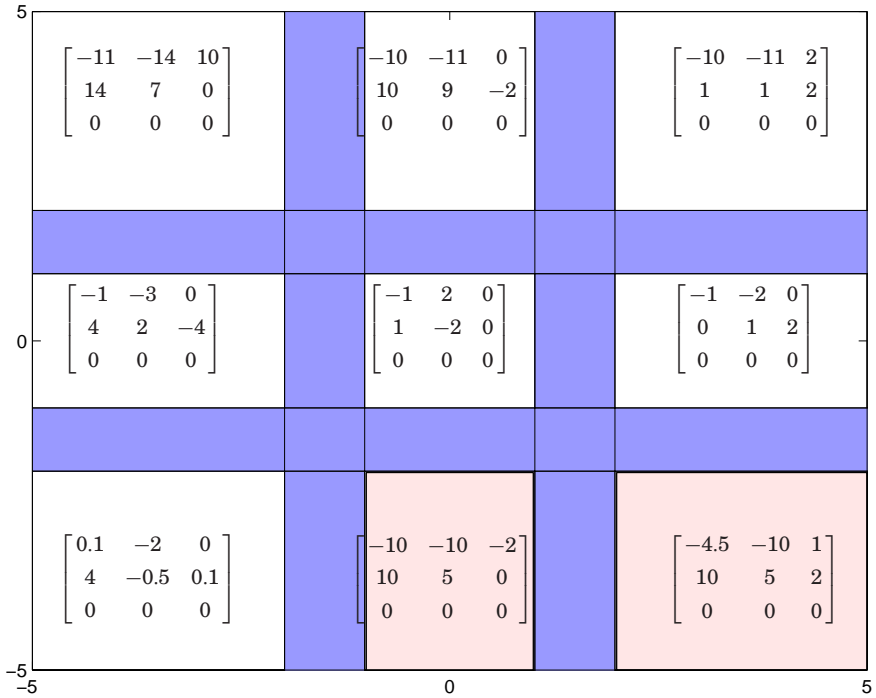

Figure 7.3 Partition of the fuzzy system defined by the rules in Table 7.1 into operating regimes and interpolation regimes. The matrices \bar{A}_i defining the dynamics in each operating regime are also shown.

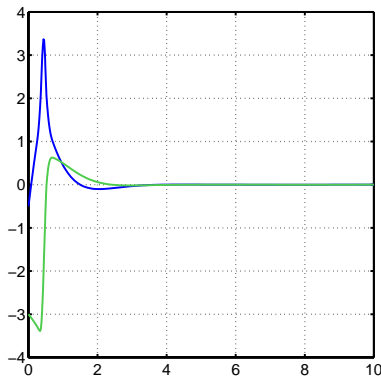

Figure 7.4 System response from a typical initial condition.

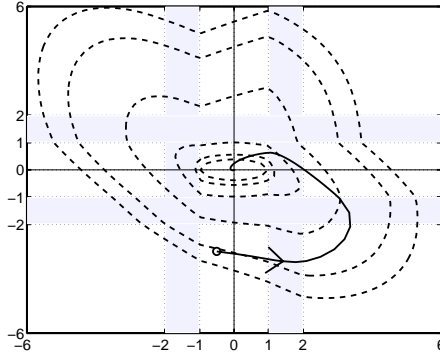

Figure 7.5 Level surfaces of the computed Lyapunov function. The guaranteed region of attraction is given by the outermost level set.

be a particular case. Exponential stability will be established using Lyapunov functions that are discontinuous in $x(t)$, but where the value of the Lyapunov function decreases every time there is a change in the discrete state. Similar to before, the analysis computations can be cast as convex optimization problems in terms of linear matrix inequalities.

A Class of Hybrid System

We consider piecewise affine systems on the form

$$\dot{x}(t) = A_{i(t)}x(t) + a_{i(t)}, \quad i(t) = \nu\{x(t), i(t^-)\} \quad (7.8)$$

with $x \in \mathbb{R}^n$ and $i \in I \subset \mathbb{Z}$. This is a particular instance of the *differential automaton* defined in [136]. Here, the differential equation describes the continuous dynamics while the algebraic equation models the state of the decision-making logic. The discrete state $i(t) \in I$ is piecewise constant. The notation t^- indicates that the discrete state is piecewise continuous from the right. The model associates one continuous affine dynamics to each value of the discrete state.

We will assume that changes in the discrete state are triggered by the evolution of the continuous dynamics. More precisely, a transition from the discrete state j to the discrete state k occurs when the continuous state hits the *transition hyperplane*

$$\bar{f}_{jk}^T \bar{x}(t) = 0$$

provided that the *enabling condition*

$$\bar{E}_k \bar{x} \succeq 0$$

is satisfied. These systems can be conveniently represented as a finite automaton with a continuous dynamics associated to each discrete state, see Figure 7.6. The leftmost arrow indicates the initial discrete state. The

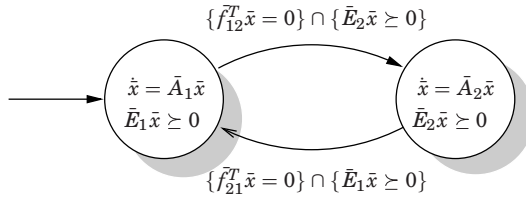

Figure 7.6 Piecewise linear hybrid system illustrated as an hybrid automaton.

following example illustrates the model class, and the need for extensions of the piecewise quadratic analysis from Chapter 4.

EXAMPLE 7.1

Figure 7.7 (left) shows a simulation of the system $\dot{x}(t) = A_{i(t)}x(t)$

$$i(t) = \begin{cases} 2, & \text{if } i(t^-) = 1 \text{ and } f_{12}^T x(t) = 0 \\ 1, & \text{if } i(t^-) = 2 \text{ and } f_{21}^T x(t) = 0 \end{cases} \quad (7.9)$$

with $i(0) = 1$, switching boundaries

$$f_{12} = [-10 \quad -1]^T, \quad f_{21} = [2 \quad -1]^T$$

and system matrices

$$A_1 = \begin{bmatrix} -1 & -100 \\ 10 & -1 \end{bmatrix}, \quad A_2 = \begin{bmatrix} 1 & 10 \\ -100 & 1 \end{bmatrix}.$$

The simulations shown in Figure 7.7 indicate that the system is asymptotically stable. From the simulated trajectory of the system, it is also clear that it is not possible to find a Lyapunov function that disregards the influence of the discrete state. □

The state space of the model (7.8), $\mathbb{R} \times \mathbb{Z}$, can be thought of as a set of enumerated copies of \mathbb{R}^n . From this perspective, a transition in the discrete state can be seen as the transfer from one copy of \mathbb{R}^n to the other, see Figure 7.8. The simulation in Figure 7.7 is the projection of this trajectory onto the continuous state space.

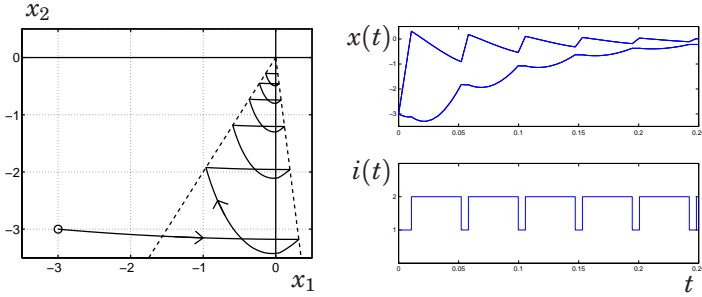

Figure 7.7 Sample trajectory of the hybrid system projected onto the continuous state space (left) and corresponding time plots (right).

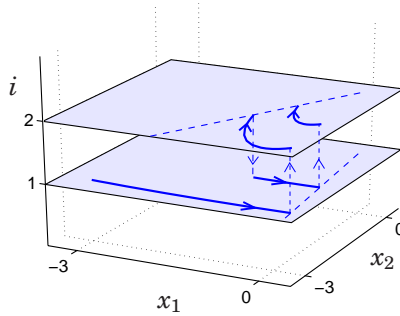

Figure 7.8 State space of hybrid system illustrated as a number of enumerated copies of \mathbb{R}^n . Changes in the discrete state transfers the state from one copy to the other.

With this basic understanding of the system class, we can now proceed to state a more technical definition. We assume that the continuous dynamics is piecewise affine,

$$\dot{x}(t) = A_{i(t)}x(t) + a_{i(t)} \quad \text{a.e.} \quad (7.10)$$

We let $I_0 \subseteq I$ be the set of indices for which $x(t) = 0$ is admissible, and let $I_1 = I \setminus I_0$. It is assumed that $a_i = 0$ for $i \in I_0$. From the transition conditions for the discrete dynamics, we construct vectors f_{ij} and \bar{f}_{ij} for $i, j \in I$ such that $f_{i,i} = 0$, $\bar{f}_{i,i} = 0$ for $i \in I$ and

$$f_{i(t^-)i(t)}^T x(t) = 0 \quad \forall t, \quad (7.11)$$

$$\bar{f}_{i(t^-)i(t)}^T \begin{bmatrix} x(t) \\ 1 \end{bmatrix} = 0 \quad \forall t. \quad (7.12)$$

To account for the enabling conditions, *i.e.*, that certain discrete states may only be admissible for a subset of the continuous states, we construct

matrices $E_{i(t)}$ and $\bar{E}_{i(t)}$ such that

$$\begin{aligned} E_{i(t)}x(t) &\succeq 0, & i(t) \in I_0, \\ \bar{E}_{i(t)} \begin{bmatrix} x(t) \\ 1 \end{bmatrix} &\succeq 0, & i(t) \in I_1. \end{aligned}$$

Discontinuous Lyapunov Functions

In the analysis of hybrid systems it is sometimes desirable to relax the requirement that the Lyapunov function should be continuous. An interesting option is to use Lyapunov functions that have a discontinuous dependence on the discrete state, but where the value of the Lyapunov function decreases at the switching instants. This is the idea behind so-called ‘multiple Lyapunov functions’, see [22]. This possibility has been incorporated in Lemma 4.1 by the requirement that $V(t)$ be decreasing and piecewise C^1 .

When the transition conditions are affine inequalities in the state, it is possible to formulate the search for this type of Lyapunov functions as a LMI problem. This can be seen by the following simple argument. Let the Lyapunov function be $V(x) = \bar{x}^T \bar{P}_{i(t)} \bar{x}$ and let the discrete state initially have the value j . Assume that the condition for the discrete state to change value from j to k is given by $\bar{f}_{jk}^T \bar{x} = 0$. Then, the requirement that the Lyapunov function should be decreasing at the switching instant,

$$\bar{x}^T P_j \bar{x} \geq \bar{x}^T P_k \bar{x} \quad \text{for } \{x \mid \bar{f}_{jk}^T \bar{x} = 0\}$$

can be expressed as the linear matrix inequality in \bar{P}_j, \bar{P}_k and \bar{t}_{jk}

$$\bar{P}_j - \bar{P}_k + \bar{f}_{jk} \bar{t}_{jk}^T + \bar{t}_{jk} \bar{f}_{jk}^T \geq 0.$$

We let $\bar{P}_i = [I \quad 0]^T P_i [I \quad 0]$ for $i \in I_0$, and state the following result.

THEOREM 7.1

Consider vectors t_{ij} and \bar{t}_{ij} , symmetric matrices U_i and W_i with non-

negative entries and symmetric matrices P_i and \bar{P}_i such that

$$\begin{cases} 0 > A_i^T P_i + P_i A_i + E_i^T U_i E_i \\ 0 < P_i - E_i^T W_i E_i \end{cases} \quad i \in I_0 \quad (7.13)$$

$$\begin{cases} 0 > \bar{A}_i^T \bar{P}_i + \bar{P}_i \bar{A}_i + \bar{E}_i^T U_i \bar{E}_i \\ 0 < \bar{P}_i - \bar{E}_i^T W_i \bar{E}_i \end{cases} \quad i \in I_1 \quad (7.14)$$

$$0 < \bar{P}_i - \bar{P}_j + \bar{f}_{ij} \bar{t}_{ij}^T + \bar{t}_{ij} \bar{f}_{ij}^T \quad i \in I_1 \text{ or } j \in I_1 \quad (7.15)$$

$$0 < P_i - P_j + f_{ij} t_{ij}^T + t_{ij} f_{ij}^T \quad i, j \in I_0 \quad (7.16)$$

where $i \neq j$, then every continuous, piecewise C^1 trajectory $x(t)$ satisfying (7.10) tends to zero exponentially. \square

Clearly, when applying Theorem 7.1 one only needs to consider those i, j that correspond to feasible transitions in the dynamics. Similar to the partition refinements in our previous analysis, it can sometimes be useful to introduce additional discrete states to obtain more flexibility in the Lyapunov function candidate.

There is a strong relation between Theorem 7.1 and Theorem 4.1. By allowing non-strict inequalities in (7.15) and (7.16), Theorem 4.1 can be seen as a special case of Theorem 7.1 where $\bar{f}_{ij} = f_{ji}$, $\forall i, j \in I$. However, a formulation with non-strict inequalities is numerically very sensitive and most LMI solvers can not treat non-strict inequalities as they stand. Inherent algebraic constraints must first be eliminated. Theorem 4.1 can be seen as the outcome of such an elimination.

Theorem 7.1 can be applied directly to the system of Example 7.1.

EXAMPLE 7.2

Consider again the switching system (7.9). To illustrate the use of enabling conditions, we let

$$E_1 = \begin{bmatrix} 0 & 0 \\ 0 & 0 \end{bmatrix}, \quad E_2 = \begin{bmatrix} -10 & -1 \\ 2 & -1 \end{bmatrix}.$$

The LMI conditions of Theorem 7.1 have a feasible solution

$$P_1 = \begin{bmatrix} 17.9 & -0.89 \\ -0.89 & 179 \end{bmatrix}, \quad P_2 = \begin{bmatrix} 739 & -38.1 \\ -38.1 & 91.8 \end{bmatrix}.$$

A simulated trajectory of the system and the corresponding value of the computed Lyapunov function are shown in Figure 7.9. The discontinuities in the Lyapunov function concur with changes in the discrete state.

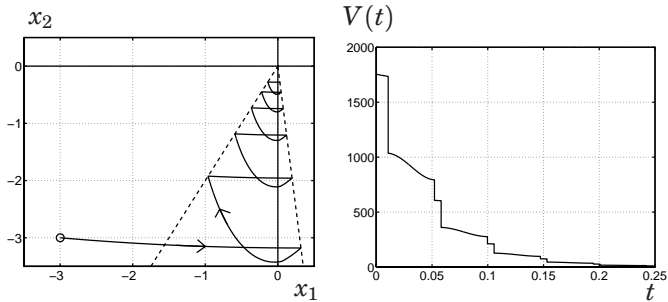

Figure 7.9 Sample trajectory of the hybrid system (left) and the corresponding value of the Lyapunov function (right).

□

Several extensions can be made to the above result. It is for example straightforward to extend the class of systems to allow differential inclusions rather than differential equations in modeling the continuous dynamics. System with alternative transition rules would also be possible. From a computational viewpoint, the most important development is the observation that the search for a Lyapunov function with specified discontinuities can be formulated as a convex optimization problem. A similar development could be done for analysis via piecewise linear Lyapunov functions.

7.3 Smooth Nonlinear Systems

Piecewise linear systems have good approximation capabilities and can in principle approximate any smooth nonlinear system to arbitrary precision. Our third extension will be to show how approximation errors can be explicitly taken into account, providing formal results for smooth systems based on a piecewise linear analysis.

One way of accounting for approximation errors is to use piecewise linear differential inclusions, as defined in Chapter 2. The idea is then to use upper and lower bounds on the nonlinearity in each polyhedral region. Stability of the original system follows if it is possible to find a Lyapunov function that is valid for all bounding systems in each region (Theorem 4.2). A problem with this approach is that a careless modeling with differential inclusions may result in a very large number of extreme systems in each region. This problem is particularly pronounced for multi-variable nonlinearities, where the analysis conditions quickly become prohibitively expensive. Another alternative is to use a norm bound of the approximation error in the following manner.

THEOREM 7.2—NORM BOUNDED APPROXIMATION ERRORS

Let $x(t)$ be a piecewise C^1 trajectory of the system $\dot{x} = f(x)$ and assume that

$$\|f(x) - A_i x - a_i\|_2 \leq \varepsilon_i \|x\|_2 \quad x \in X_i, i \in I.$$

If there exists numbers $\gamma_i > 0$, symmetric matrices U_i and W_i with non-negative entries, and a symmetric matrix T such that $P_i = F_i^T T F_i$ and $\bar{P}_i = \bar{F}_i^T T \bar{F}_i$ satisfy

$$-2\varepsilon_i \gamma_i I > A_i^T P_i + P_i A_i + E_i^T U_i E_i \quad (7.17)$$

$$E_i^T W_i E_i < P_i < \gamma_i I \quad (7.18)$$

for $i \in I_0$ and

$$-2\varepsilon_i \gamma_i I > \bar{A}_i^T \bar{P}_i + \bar{P}_i \bar{A}_i + \bar{E}_i^T U_i \bar{E}_i \quad (7.19)$$

$$\bar{E}_i^T W_i \bar{E}_i < \bar{P}_i < \gamma_i I \quad (7.20)$$

for $i \in I_1$, then $x(t)$ tends to zero exponentially. \square

Proof: Define the function

$$\bar{V}(x) = \bar{x}^T \bar{P}_i \bar{x} \quad x \in X_i, \quad i \in I. \quad (7.21)$$

The inequalities (7.18) and (7.20) imply the existence of $c_1, c_2 > 0$ such that

$$c_1 \|x\|_2^2 \leq \bar{V}(x) \leq c_2 \|x\|_2^2$$

Let the approximation error be described by

$$\tilde{a}_i(x) = \begin{bmatrix} f(x) - A_i x - a_i \\ 0 \end{bmatrix} \quad x \in X_i, \quad i \in I.$$

Then, inequalities (7.17) and (7.19) and the assumption $\|\tilde{a}_i(x)\|_2^2 \leq \varepsilon_i \|x\|_2^2$ imply

$$\begin{aligned} \frac{d}{dt} \bar{V}(x) &= 2\bar{x}^T \bar{P}_i \begin{bmatrix} f(x) \\ 0 \end{bmatrix} \\ &= \bar{x}^T (\bar{A}_i^T \bar{P}_i + \bar{P}_i \bar{A}_i) \bar{x} + 2\bar{x}^T \bar{P}_i \tilde{a}_i(x) \\ &< -2(\varepsilon_i \gamma_i + \delta) \|x\|_2^2 + 2\gamma_i \|x\|_2 \cdot \|\tilde{a}_i(x)\|_2 \\ &\leq -\delta \|x\|_2^2 \leq -\delta \bar{V}(x) / c_2 \end{aligned}$$

for some $\delta > 0$. This proves exponential decay.

Theorem 7.2 quantifies the trade-off between computational effort and precision in the analysis. If no solution to the above matrix inequalities can be found, it is natural to refine the partitioning of the state space used in the piecewise linear approximation and the piecewise quadratic Lyapunov function, and to try again. The partition refinements decrease the approximation error and increase the flexibility of the Lyapunov function candidates, but introduces additional matrix inequalities in the analysis problem. For such an approach to be useful, it is important to have support for partition refinements, so that increased flexibility is introduced where it is needed the most.

7.4 Automated Partition Refinements

A powerful feature of piecewise linear systems is the possibility to do partition refinements. These refinements increase the accuracy in the non-linearity description and improve the flexibility of the Lyapunov function candidate. For a piecewise linear system with an initial cell partition for the dynamics it is natural (but not necessary) to use the same partition for the Lyapunov function. There are many examples where a refined partition is needed for the analysis. In Example 4.8, the initial partition for the dynamics consisted of two cells, but this partition had to be refined into a partition with four cells before a solution to the analysis inequalities could be found. To verify stability of the smooth nonlinear system in Example 4.7, it was necessary to refine a (globally) linear differential inclusion into a piecewise linear differential inclusion in order to verify stability. For simple examples, the partition refinements can often be made in an ad hoc manner. For more complex examples, however, it is important to have some kind of support that indicates where partition refinements are needed the most. In Section 5.3, discrepancies in the loss functions used for estimating upper and lower performance bounds was used for guiding the partition refinements. In this section we will show how linear programming duality can be used for automated partition refinements in the stability analysis based on piecewise linear Lyapunov functions. Results are only given for simplex partitions and piecewise linear Lyapunov functions.

Introducing Flexibility where Needed

To illustrate the ideas, consider the problem of finding a piecewise linear Lyapunov function on a polytopic partition. Rather than solving the lin-

ear programming problem as it stands in Theorem 4.4, we consider the following slight modification

$$\begin{array}{ll}
 \min_{t, \tau} \tau & \text{subject to} \\
 \tau > p_i^T A_i v_k & i \in I_0, v_k \in X_i, \\
 \tau > \bar{p}_i^T \bar{A}_i \bar{v}_k & i \in I_1, v_k \in X_i.
 \end{array} \tag{7.22}$$

In this formulation, exponential stability according to Theorem 4.4 is obtained when $\tau < 0$. If the optimal value of the linear program is positive, no piecewise linear Lyapunov function exists on the current partition. In this case it is reasonable to find the cell which imposes the strongest constraint on the optimization problem and to subdivide this cell in order to increase the flexibility of the Lyapunov function candidate. The computations can then be repeated, proving stability or suggesting further partition refinements.

In the case of linear programming, it is particularly simple to obtain the information about to what degree a certain constraint restricts the optimal value τ . This sensitivity information is obtained as the solution to the associated dual problem (many LP solvers, such as [34], solve the primal and the dual problem simultaneously so this step need not require any additional computations). One approach would then be to split the cell that corresponds to the largest dual variable. Since there are many constraints associated to each cell, another possibility is to compute the “total constraint cost” for each cell as the sum of the dual variables associated to it. The cell with the largest constraint cost can then be subdivided. An iterative refinement procedure can then proceed along the steps of the following algorithm.

ALGORITHM 7.1—AUTOMATED PARTITION REFINEMENTS

1. Solve the linear program associated to Theorem 4.4, modified as in (7.22).
2. If $\tau < 0$, the procedure has terminated and asymptotic stability has been proven. Otherwise, refine the cell with the highest constraint cost and return to 1.

□

Cell Splitting

After deciding which cell to subdivide, one must also decide how this subdivision should be carried out. This appears to be a delicate issue, since

not every splitting operation increases the flexibility of the Lyapunov function. The simple idea of splitting a cell by introducing a new vertex in its center has the disadvantage that the boundaries of the cells are never refined (see Figure 7.10a). We therefore suggest to split a cell by introducing

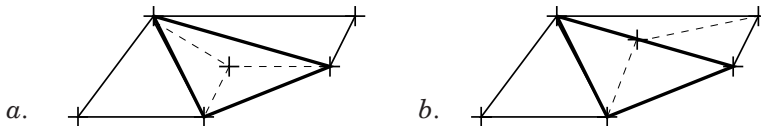

Figure 7.10 Procedures for subdividing a simplex; insertion of a new vertex in the center of a cell (left), or at the center of the largest boundary.

a new vertex in the center of its longest edge (see Figure 7.10b). Note that this operation induces a subdivision also of the neighboring cells. Since the vector field in cells containing the origin is homogeneous, we propose to split these cells by introducing a new vertex in the largest edge of the face facing the origin.

The following example illustrates the duality-based partition refinements.

EXAMPLE 7.3

Consider the following system

$$\begin{cases} \dot{x}_1 = x_2 \\ \dot{x}_2 = -5x_1 - x_2 - \text{sat}(x_1 + x_2) \end{cases} \quad (7.23)$$

where $\text{sat}(x)$ denotes the unit saturation. This system is piecewise linear and has oscillatory dynamics in both the linear and the saturated operating regions. It is well-known that piecewise linear Lyapunov functions may require a rather fine partition of the state space in order prove stability of oscillatory systems [96, 111]. Indeed, for the coarse initial partition shown in Figure 7.11 (left), no piecewise linear Lyapunov function can be found. Based on this initial partition, however, the automatic refinement procedure terminates with the partition shown in Figure 7.11 (right). The corresponding Lyapunov function, shown in Figure 7.12 (left) guarantees exponential decay of all trajectories within the estimated region of attraction, shown as the outermost level set in Figure 7.12 (right).

□

Admittedly, the suggested refinement procedure has been based on a large portion of heuristics, and many important problems remain open. Is it,

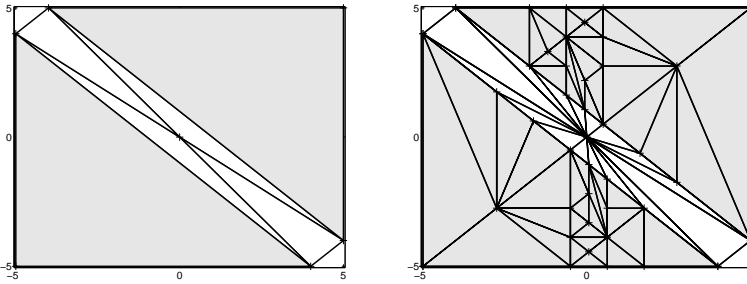

Figure 7.11 Initial partition (left) and automatically refined partition (right) of Example 7.3.

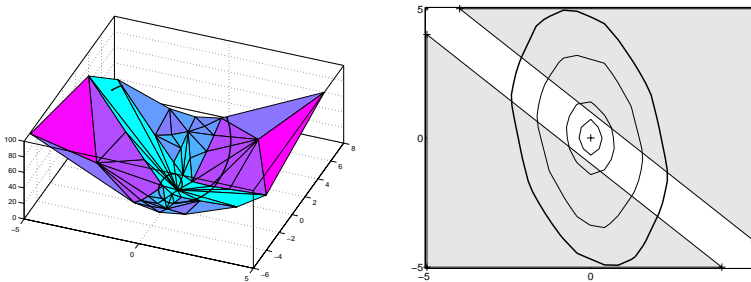

Figure 7.12 Lyapunov function (left) and guaranteed region attraction (right) in Example 7.3.

for example, possible to prove that the refinement procedure terminates in a finite number of steps? If so, under what conditions?

7.5 Comments and References

Stability Analysis of Fuzzy Systems

The fuzzy community may have been first in using LMI computations for design and analysis of nonlinear control laws [156, 135]. The need to move beyond quadratic Lyapunov functions has also been pointed out [80]. In fact, the use of discontinuous piecewise quadratic Lyapunov functions has also been used in the independent work [38]. In comparison with these results, an application of Theorem 4.2 to fuzzy systems constitutes a number of significant improvements. This includes the use of the

S -procedure to exploit structural information, and the ability to handle affine Takagi-Sugeno systems. Moreover, [38] give procedures for computing different Lyapunov matrices for each region. To assure stability of the system, however, one must verify that certain boundary conditions hold. It is suggested that these boundary conditions could be verified by simulation. In contrast, the approach taken in this thesis avoids this non-trivial step by parameterizing the Lyapunov function candidates to be continuous across cell boundaries.

Analysis of Piecewise Linear Hybrid Systems

The area of hybrid control has attracted a large interest over the last couple of years. A very useful idea has been the notion of ‘multiple Lyapunov functions’ see [22, 23] (see also [106, 107]). Our main contribution has been to show how the search for these kinds of Lyapunov functions can be formulated as an LMI problem [63, 66]. This allows efficient construction of Lyapunov functions for a class of hybrid systems. Similar ideas has been presented in the independent work [108]. Further aspects on LMI-based analysis of hybrid systems can be found in [45].

8

Computational Issues

The results derived in the previous chapters allow analysis and design of piecewise linear control systems based on numerical computations. For clarity of presentation, detailed discussions about computational issues have been postponed to this chapter.

The computations derived in this thesis have made heavy use of the constraint matrices \bar{G}_i , \bar{E}_i and \bar{F}_i without actually going into details of how these matrices can be determined for a given partition. In this section, we will show how these matrices can be computed for two important classes of partitions. In both cases, the constraint matrices can be computed efficiently using simple manipulations. Moreover, we illustrate how constraint matrices for complicated partitions can sometimes be computed from the descriptions of simpler partitions. We will also show how quadratic cell boundings with minimal volume can be computed for polyhedral cells. For two important classes of polytopes, we will derive explicit expressions for the circumscribing ellipsoid with minimum volume.

The S -procedure has played an important role in many computations. How restrictive the computations are depends on the conservatism of the S -procedure. In this chapter, we will provide some further insight in the role of the S -procedure, and derive two interesting results. Both consider simplex partitions. The first result states that analysis based on the polyhedral S -procedure is always less conservative than the use of minimum volume ellipsoids. Furthermore, we will establish non-conservatism of the polyhedral S -procedure for simplex cells in \mathbb{R}^n with $n \leq 3$.

Finally, we present a Matlab toolbox for analysis of piecewise linear systems. A set of intuitive commands allow specification of piecewise linear systems. Many of the analysis results, such as stability analysis and \mathcal{L}_2 gain computations, are then available as single commands. Included in the toolbox is also a simulation engine for piecewise linear systems with discontinuous dynamics. The tool allows efficient and accurate simulation of systems with sliding modes on cell faces.

8.1 Computing Constraint Matrices

The partitioning of a domain into convex polyhedra with disjoint interior can be made in a large number of ways. The analysis procedures developed in this thesis are not restricted to any particular partition type, but they do require that some key properties of the partition are expressed in the specific matrix format defined in Section 4.5. The purpose of this parameterization is to efficiently separate the free parameters of the piecewise quadratic function from the continuity constraint imposed by the partition. For such a parameterization to be useful, we need to be able to compute these matrices for a given partition. In this section, we will show how the necessary constraint matrices can be computed efficiently from partition data.

Simplex and Hyperplane Partitions

A fundamental result from polytope theory states that every convex polytope admits two alternative but equivalent representations. A convex polytope can be represented either as the convex hull of its vertices, or as the intersection of its supporting halfspaces, see *e.g.*[157]. From these two descriptions, two classes of partitions appear particularly natural. One class is the partitions induced by a number of hyperplanes, the other is the partitions induced by a number of points. We will call these partition types hyperplane and simplex partitions, respectively.

A *hyperplane partition* is a partition which is induced by a number of hyperplanes. The cells of a hyperplane partition are convex polyhedra that have these hyperplanes as boundaries. Given a set of convex polyhedra, the associated hyperplane partition is obtained by extending the cell boundaries globally. This extension of boundaries may induce new cells, see Figure 8.1. Hence, a partition obtained in this way may have more cells than the number of polyhedra that generated it.

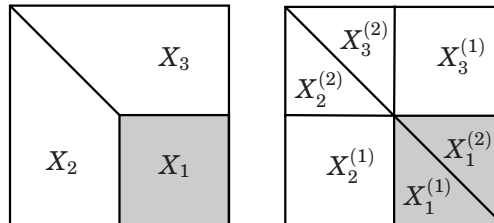

Figure 8.1 A hyperplane partition generated from an initial set of polyhedra by extending their boundaries globally.

A *simplex partition* is a partition induced by a number of grid points. A simplex in \mathbb{R}^n is defined as the convex hull of $n + 1$ affinely independent points. The affine independence guarantees that the simplex has non-empty interior and does not “collapse” in some direction. The cells of the partition are simplices that have $n + 1$ of the grid points as its vertices. Given a set of points, these can be combined into many different simplex partitions, see Figure 8.2. In other words, a set of vertices does not induce a unique simplex partition (see [82] for further details on triangulations). Every convex polytope can be partitioned into simplices by the possible insertion of new vertices. Thus, given some initial polytopical partition, it can always be refined into a simplex partition. A simplex partition derived in this way may then have more cells than the original (non-simplex) partition that generated it, see Figure 8.2.

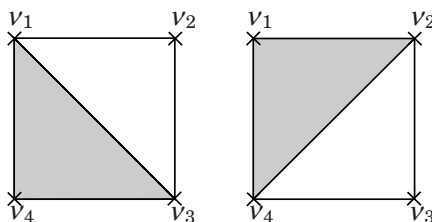

Figure 8.2 Two simplex partitions induced by the four vertices v_k of a square.

Constraint Matrices for Hyperplane Partitions

A hyperplane partition is a partition induced by K hyperplanes,

$$\mathcal{H}_k = \{x \mid h_k^T x + g_k = 0\} \quad k = 1, \dots, K.$$

The partition induced by a saturated linear state feedback is a typical example, see Figure 2.1. For convenient representation, we collect all hyperplane data in a *hyperplane matrix*, \tilde{H} . This matrix is obtained by stacking the vectors that define the hyperplane equations on top of each other,

$$\tilde{H} = \begin{bmatrix} h_1^T & g_1 \\ \vdots & \vdots \\ h_p^T & g_p \end{bmatrix}.$$

We adopt the convention that every hyperplane is defined with $g_k \leq 0$.

Each hyperplane induces two closed halfspaces,

$$\begin{aligned}\mathcal{H}_k^+ &= \{x \mid h_k^T x + g_k \geq 0\} \\ \mathcal{H}_k^- &= \{x \mid h_k^T x + g_k \leq 0\}\end{aligned}$$

which we will call the positive and negative induced halfspace of \mathcal{H}_k , respectively. The convention $g_k \leq 0$ then implies that $0 \in \mathcal{H}_k^-$ for all k .

Each cell of the partition is defined as the intersection of K of these induced halfspaces. Hence, cells can be specified by stating whether they belongs to the positive or negative induced halfspace of each hyperplane. In this way, an associated cell identifier \bar{G}_i is obtained by multiplying the k th row of \bar{H} with -1 if $X_i \subseteq \mathcal{H}_k^-$ and with $+1$ if $X_i \subseteq \mathcal{H}_k^+$. However, such a representation has many redundant constraints and it is sufficient to consider the halfspaces induced by the boundaries of the cell.

Polyhedral cell boundings \bar{E}_i can be obtained from the cell identifiers \bar{G}_i by a direct application of Algorithm 4.1.

Continuity matrices \bar{F}_i can be computed as follows. Let the k th row of \bar{F}_i be equal to the k th row of \bar{H} if $X_i \subseteq \mathcal{H}_k^+$ and equal to the zero vector otherwise. Since $0 \in \mathcal{H}_k^-$ for all k , this assures that

$$\bar{F}_i \bar{x} = \max \{ \bar{H} \bar{x}, \mathbf{0} \} \quad x \in X_i,$$

where $\max(z, v)$ denotes element-wise maximum. This implies that the matrices \bar{F}_i have the zero interpolation property. We summarize the development in the following proposition.

PROPOSITION 8.1—CONSTRAINT MATRICES FOR HYPERPLANE PARTITIONS

Let $\{X_i\}_{i \in I}$ be a hyperplane partition. The matrices \bar{G}_i and \bar{F}_i constructed as above satisfy the conditions (4.17) and (4.14), respectively. Moreover, the matrices \bar{F}_i have the zero interpolation property. \square

In order to give the \bar{F}_i matrices full column rank, it may sometimes be necessary to augment the matrices computed in this way according to

$$\bar{F}_i = \begin{bmatrix} \bar{F}_i & f_i \\ I & 0 \end{bmatrix}. \quad (8.1)$$

The constraint matrices for the saturated system given in Example 2.3, Example 4.4 and Example 4.5 were computed using the procedure outlined above. The following example illustrates the use of the hyperplane matrix when computing the cell identifier for one of the three regions.

EXAMPLE 8.1—CONSTRAINT MATRICES FOR SATURATED SYSTEM
Consider again the linear system with actuator saturation,

$$\dot{x} = Ax + b \operatorname{sat}(k^T x)$$

The hyperplanes induced by the saturation give the hyperplane matrix

$$\bar{H} = \begin{bmatrix} h_1^T & g_1 \\ h_2^T & g_2 \end{bmatrix} = \begin{bmatrix} k^T & -1 \\ -k^T & -1 \end{bmatrix}.$$

Note that $g_k \leq 0$ for all k . Consider the cell X_3 corresponding to positive saturation ($k^T x \geq 1$). Since $X_3 \subseteq \mathcal{H}_1^+$ and $X_3 \subseteq \mathcal{H}_2^-$ we can obtain a cell identifier by multiplying the second row of \bar{H} with -1 . This gives

$$\tilde{G}_3 = \begin{bmatrix} k^T & -1 \\ k^T & 1 \end{bmatrix}.$$

As only \mathcal{H}_1 is a cell boundary of X_3 , we delete the second row of \tilde{G}_3 and arrive at

$$\bar{G}_3 = [k^T \quad -1],$$

which was the cell identifier given in Example 2.3. □

Constraint Matrices for Simplex Partitions

A *simplex partition* is a partition induced by a number of points $\{v_k\}$. The cells of the partition are convex polytopes with $n + 1$ of these points as its vertices. A typical example is the partition that was used for approximation of a smooth function in Example 2.2. More formally, a simplex in \mathbb{R}^n is defined as the convex hull of $n + 1$ of affinely independent points. The affine independence guarantees that the simplex has non-empty interior and does not “collapse” in some direction.

Let $X_i \subset \mathbb{R}^n$ be a simplex. Each $x \in X_i$ has a unique representation as a convex combination of the cell vertices

$$x = \sum_k z_k v_k, \quad x, v_k \in X_i \quad (8.2)$$

with $z_k \geq 0$, $\sum_k z_k = 1$. The numbers z_k are sometimes called the barycentric coordinates of X_i . If the decomposition (8.2) is used for $x \notin X_i$, then at least one of the barycentric coordinates will be negative. This indicates that the mapping from x to the barycentric coordinates of X_i would qualify as cell identifier (which is exactly what we will use later).

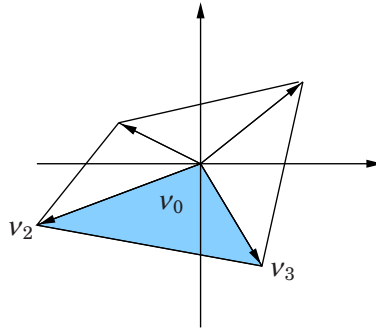

Figure 8.3 Simplex partition of state space.

The representation (8.2) can be extended in a natural way to describe all points that belong to the partition. Each $x \in \cup_{i \in I} X_i$ can be written as a weighted sum of the vertices of the partition

$$x = \sum_k z_k v_k. \quad (8.3)$$

Within each simplex X_i we can recover the decomposition (8.2) by letting $z_k = 0$ for all k such that $v_k \notin X_i$. Clearly, we still have $\sum_k z_k = 1$. Let $z = [z_1 \ \dots \ z_K]$ be the vector of partition coordinates. Then, for every $x \in X_i$ the only non-zero entries of z are those coordinates that correspond to vertices of X_i . Moreover, on a boundary between two simplices the only non-zero coordinates are those z_k that describe this common boundary. This implies that the decomposition (8.3) defines a continuous piecewise linear mapping $x \rightarrow z$ which is unique for every $x \in X_i$. It is this mapping that will be used for constructing continuity matrices.

To describe the computations, we let v_1, \dots, v_p be the vertices of the partition and introduce the vertex matrix

$$\bar{\mathcal{V}} = [\bar{v}_1 \ \dots \ \bar{v}_p], \quad (8.4)$$

For each simplex X_i , we define an *extraction matrix* $\mathcal{E}_i \in \mathbb{R}^{p \times (n+1)}$ as follows. The k th row of \mathcal{E}_i is zero for all k such that $v_k \notin X_i$ and the non-zero rows of \mathcal{E}_i are equal to the rows of an identity matrix. The extraction matrix then has the property that $z = \mathcal{E}_i \mathcal{E}_i^T z$ when $x \in X_i$. The constraint matrices \bar{G}_i and \bar{F}_i are now computed as follows,

$$\bar{G}_i = (\bar{\mathcal{V}} \mathcal{E}_i)^{-1}, \quad \bar{F}_i = \mathcal{E}_i \bar{G}_i \quad \text{for } i \in I. \quad (8.5)$$

The matrix $(\bar{\mathcal{V}} \mathcal{E}_i)$ is invertible due to the non-empty interior of X_i . We give the following result.

PROPOSITION 8.2—CONSTRAINT MATRICES FOR SIMPLEX PARTITIONS

Let $\{X_i\}_{i \in I}$ be a simplex partition. The matrices \bar{G}_i and \bar{F}_i as constructed in (8.4) and (8.5) satisfy the conditions (4.17) and (4.14), respectively. Moreover, if $v_k = 0$ for some k , then the continuity matrices with zero interpolation property are obtained by deleting the k th row of all matrices \bar{F}_i computed as above. \square

Cell boundings \bar{E}_i can be computed via Algorithm 4.1.

The construction extends straightforwardly to unbounded polyhedra by allowing simplices to have vertices “at infinity”. In this case every $x \in X_i$ can be written as

$$x = \sum_{k=1}^q z_k v_k + \sum_{k=q+1}^p z_k d_k$$

where $z_k \geq 0$ and $\sum_{k=0}^q z_k = 1$. The vectors v_1, \dots, v_k are vertices defining a polytope, while d_{q+1}, \dots, d_p define directions that span a cone with base in this polytope. The computations of constraint matrices remain the same and statements above hold true also in this case, provided that each cell has at least one vertex and that we define

$$\bar{V} = \begin{bmatrix} v_1 & \dots & v_q & d_{q+1} & \dots & d_p \\ 1 & \dots & 1 & 0 & \dots & 0 \end{bmatrix}.$$

Building Complex Partitions from Simple Partitions

In the computations above we have let the dimension of the partition be the same as the dimension of the state space. In other words, the partitioning has been done with respect to all state variables. In many cases, significant nonlinearities may be confined to some subset of the state space. This was for example the case with the min-max selector system defined in Section 4.6. It can then be natural to concentrate the flexibility of the Lyapunov function candidate to these states.

Partitioning a Subset of the State Assume that the partitioning has been performed on the subspace

$$Z = \{z \in \mathbb{R}^q \mid z = Cx, \quad x \in \mathbb{R}^n\}$$

Then, the constraint matrices constructed on \mathbb{R}^q can be used to describe the induced partition in \mathbb{R}^n by post-multiplying the constraint matrices by

$$N = \begin{bmatrix} C & 0 \\ 0 & 1 \end{bmatrix}$$

That is, let \bar{F}_{Z_i} , \bar{E}_{Z_i} and \bar{G}_{Z_i} be constraint matrices for a polyhedral partition in \mathbb{R}^q , let $C \in \mathbb{R}^{q \times (n+1)}$, and let N be defined as above. Then,

$$\bar{F}_i = \bar{F}_{Z_i}N, \quad \bar{E}_i = \bar{E}_{Z_i}N, \quad \bar{G}_i = \bar{G}_{Z_i}N,$$

are constraint matrices for the corresponding cells in \mathbb{R}^n . Moreover, if \bar{F}_{Z_i} and \bar{E}_{Z_i} have the zero interpolation property, then so have \bar{F}_i and \bar{E}_i . This approach was used to construct constraint matrices for the min-max selector system analyzed in Chapter 4.

If the constructed continuity matrix does not have full row rank, this can be achieved by the augmentation (8.1).

Creating Cells by Intersecting Partitions Another issue appears when we interconnect two piecewise linear systems for which we have already computed constraint matrices. Thus, let S_1 be a piecewise linear component with state vector $x_1 \in \mathbb{R}^{n_1}$, and S_2 be a piecewise linear component with state vector $x_2 \in \mathbb{R}^{n_2}$. Then, the interconnected system may be realized with a state vector $x \in \mathbb{R}^n$ with $n = n_1 + n_2$.

The partition of the interconnected system is obtained as the “product” between the partitions of the components,

$$V_{ij} = \{(x, z) \mid x \in X_i, z \in Z_j\}$$

$$\{X_i\}_{i \in I} \times \{Z_j\}_{j \in J} := \{V_{ij} \mid i \in I, j \in J\}$$

The corresponding constraint matrices can be constructed by first extending the constraint matrices for the subsystems into $\mathbb{R}^{n_1} \times \mathbb{R}^{n_2}$, and then stacking them on top of each other (creating the intersection). For example, let \bar{F}_{1i} and \bar{F}_{2j} be continuity matrices for two partitions. Then, the continuity matrices for the product partition are given by

$$\bar{F}_{ij} = \begin{bmatrix} F_{1i} & 0 & f_{1i} \\ 0 & F_{2j} & f_{2j} \end{bmatrix}.$$

Similar to above, if the constraint matrices of the individual components have the zero interpolation property, then so have the matrices describing the product partition.

This approach was used in the construction of constraint matrices for the fuzzy system example in Section 7.1.

Computing Ellipsoidal Cell Boundings

As we have seen in Chapter 4, substantial computational savings can be obtained if we use quadratic cell boundings rather than the polyhedral. This approach requires that we fix quadratic bounding for each cell before

carrying out the piecewise quadratic analysis. A natural candidate for quadratic approximation of a polyhedral set is to use the ellipsoid with minimum volume that contains the set [44]. The minimal volume ellipsoid containing a polytope can be obtained by solving the following convex optimization problem, see [143].

PROPOSITION 8.3—MINIMAL VOLUME ELLIPSOIDS

Let X_i be a convex polytope with vertices v_{ik} ,

$$X_i = \{x \mid x \in \overline{\text{co}}(v_{i1}, \dots, v_{iK})\}$$

The ellipsoid

$$\mathcal{E}_i = \{x \mid \|P_i x + b_i\|_2 \leq 1\}$$

of minimum volume that contains X_i is given by the solution to the strictly convex optimization problem

$$\begin{aligned} \min_{P_i, b_i} \quad & \ln \det P_i^{-1} \\ \text{s.t.} \quad & P_i = P_i^T > 0 \\ & \begin{bmatrix} I & P_i v_{ik} + b_i \\ (P_i v_{ik} + b_i)^T & 1 \end{bmatrix} \geq 0 \quad \text{for } k = 1, \dots, K \end{aligned}$$

□

Given a solution P_i, b_i to the above optimization problem, the corresponding ellipsoidal cell boundings \bar{S}_i of Definition 4.3 are given by

$$\bar{S}_i = \begin{bmatrix} -P_i^T P_i & -P_i^T b_i \\ -b_i^T P_i & 1 - b_i^T b_i \end{bmatrix}.$$

In order to compute the minimum volume ellipsoid, we need to compute all vertices of the cell. The necessary computation, called a vertex enumeration, may be computationally intensive [6]. First when the vertices are found, Proposition 8.3 can be invoked to compute the optimal bounding ellipsoid. The need to perform a vertex enumeration reduces the actual savings in the use of ellipsoidal cell boundings. As we will see next, however, it is possible to derive explicit expressions for the minimal volume ellipsoids containing simplex and hyper-rectangular cells. These results make the application of ellipsoidal cell boundings easy and computationally efficient for these types of cells. To the best of the author's knowledge, the problem of finding minimal volume ellipsoids appears to have attracted little interest in the mathematical literature (see [69, 8] for some related results). We have the following results.

PROPOSITION 8.4—SIMPLEX BOUNDING

Let X_i be a simplex with non-empty interior, and let \bar{G}_i be the corresponding cell identification matrix, as computed in (8.5). Then, the ellipsoid of minimum volume that contains X_i is given by

$$\bar{x}^T \bar{G}_i^T \bar{G}_i \bar{x} \leq 1.$$

□

Proof: See Appendix A.

PROPOSITION 8.5—PARALLELEPIPED BOUNDING

Let $X_i \subset \mathbb{R}^n$ be a parallelepiped with non-empty interior,

$$X_i = \{x \in \mathbb{R}^n \mid |c_i^T x - \tilde{x}_i| \leq d_i, \quad i = 1, \dots, n\}$$

and let

$$\bar{T} = \begin{bmatrix} c_1^T/d_1 & -\tilde{x}_1/d_1 \\ \vdots & \vdots \\ c_n^T/d_n & -\tilde{x}_n/d_n \end{bmatrix}$$

Then, the ellipsoid of minimal volume that contains X_i is given by

$$\bar{x}^T \bar{T}^T \bar{T} \bar{x} \leq n$$

□

Proof: See Appendix A.

8.2 On the S-procedure in Piecewise Quadratic Analysis

The S -procedure-relaxation plays a crucial role in the piecewise quadratic computations. It is this approach that let us express that the inequality

$$V(x) = \bar{x}^T \bar{P}_i \bar{x} > 0$$

need only to hold for $x \in X_i$ via LMIs. How restrictive our computations are depend on the conservatism of the S -procedure.

In [153] it was shown that the S -procedure is necessary and sufficient to account for a single quadratic constraint. In other words, let

$$\mathcal{E}_i = \{x \mid x^T S_i x \geq 0\}$$

be a quadratic set. Then the quadratic form

$$V(x) = x^T P_i x \tag{8.6}$$

is positive for all $x \in \mathcal{E}_i$ with $x \neq 0$ if and only if there exists a non-negative scalar $u_i \geq 0$ such that the following LMI condition is satisfied

$$P_i - u_i S_i > 0.$$

Clearly, if we consider a set given as the intersection of several quadratic sets, $\mathcal{E} = \bigcap_{i=1}^m \mathcal{E}_i$ and there exists $u_i \geq 0$ such that

$$P_i - \sum_{i=1}^m u_i S_i > 0 \tag{8.7}$$

then $V(x)$ defined in (8.6) is positive for all $x \in \mathcal{E}$. However, as was shown by a simple example in [153] this condition is only sufficient. In other words, there are quadratic functions $V(x)$ that are positive on sets on the form \mathcal{E} with $m > 1$, but where no solution to the LMI condition (8.7) can be found.

Let e_{ik} denote the columns of \bar{E}_i . Then, the polyhedral S -procedure-relaxation can be seen as a special case of (8.7) via

$$P_i - \bar{E}_i^T U_i \bar{E}_i = P_i - \sum_{j,k} u_{jk} e_{ij} e_{ik}^T > 0$$

This indicates that the S -procedure is only a sufficient condition for verifying positivity of a piecewise quadratic function on a polyhedral domain.

It is then easy to come to the premature conclusion that it is more conservative to use polytopic relaxations than to fix a quadratic set approximation and use this in the LMI computations. In this section, we will show how this is not the case. For some important classes of partitions we will be able to prove that the polytopic relaxation is always stronger than quadratic relaxations. Moreover, based on separation results for so-called copositive matrices, we will prove that the polytopic S -procedure-relaxation is non-conservative for simplex partitions in \mathbb{R}^n with $n \leq 3$.

Polyhedral Relaxation is Stronger than Ellipsoidal

By a comparative example in Chapter 4, we illustrated how the use of ellipsoidal cell description in the S -procedure allows significant computational savings in the analysis computations compared to the use of polytopic relaxations. However, as the same example indicated, these savings

come at the price of increased conservatism in the analysis. The developments in Section 8.1 will now allow us to be more precise in this issue. More specifically, we will show that if the piecewise quadratic computations with minimum volume ellipsoids as cell boundings have a solution, then so have the computations in Theorem 4.1, while the opposite is not always true. This is contrary to a statement in [44](Section 4.1) where it was indicated that computations using ellipsoidal cell boundings would be less conservative than those using polyhedral relaxations, since the S-procedure may be lossy when several quadratic terms are used.

PROPOSITION 8.6—POLYHEDRAL RELAXATION IS STRONGER THAN ELLIPSOIDAL Let X_i be a simplex cell. Let \bar{E}_i be the associated cell bounding satisfying (4.18), and let \bar{S}_i describe the minimal volume ellipsoidal boundings computed as in Proposition 8.4. Then, the polytopic S-procedure relaxation $\bar{E}_i^T U_i \bar{E}_i$ is stronger than the S-procedure using minimum volume ellipsoids, $u_i \bar{S}_i$. More precisely, if the LMI

$$\bar{P}_i - \tau_i \bar{S}_i > 0 \tag{8.8}$$

has a solution, then so has the LMI

$$\bar{P}_i - \bar{E}_i^T U_i \bar{E}_i > 0, \tag{8.9}$$

but there are cases when (8.9) admits a solution while (8.8) does not. \square

Proof: See Appendix A.

A similar result can be established also for hyper-rectangular cells.

To understand the use of the S-procedure in the piecewise quadratic analysis, it is fruitful to consider the problem of verifying the constraint

$$\bar{x}^T \bar{P}_i \bar{x} > 0 \qquad x \in X_i$$

using LMI computations. In this case, the role of the S-procedure is to separate the set $V_i^- = \{x \mid \bar{x}^T \bar{P}_i \bar{x} < 0\}$ from the set X_i . The volume of the covering ellipsoid may have very little to do with this separation. This is illustrated in Figure 8.4. The minimum volume ellipsoid of X_i intersects the set V^- , hence it cannot be used to verify the desired inequality. By using the polyhedral relaxation, there is a lot of freedom in optimizing over the quadratic bounding, and separation can easily be accomplished, see Figure 8.4(right).

Another point is that although the S-procedure is only sufficient when there is more than one quadratic constraint, adding new constraints can never make the inequalities harder to satisfy since the associated multipliers can always be set to zero. On the contrary, adding new terms may allow separations that would otherwise not be possible.

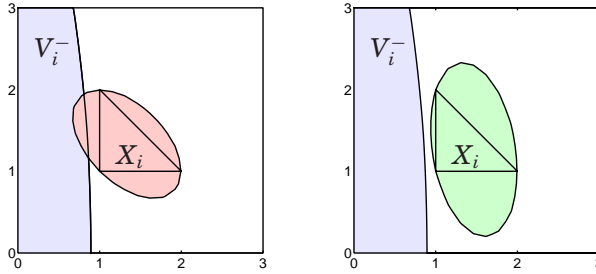

Figure 8.4 The counter example in Proposition 8.6. The minimal volume ellipsoid fails to separate X_i from V_i^- (left), while optimizing over the covering ellipsoids using the polyhedral formulation easily finds a separating supset.

Copositivity and Non-Conservatism of the S-procedure

There is a lot of structure in the way computations are made for simplex partitions. In this section, we will use this structure further to prove that the polytopic relaxation is both necessary and sufficient for the piecewise quadratic computations on simplices in \mathbb{R}^n with $n = 1, 2, 3$.

In what follows, we let X_i be a simplex in \mathbb{R}^n with associated continuity matrix \bar{F}_i and cell bounding \bar{E}_i computed as in Section 8.1. Consider verification of the inequality

$$\bar{x}^T \bar{F}_i^T T \bar{F}_i \bar{x} \geq 0 \quad x \in X_i. \quad (8.10)$$

Recall that in the simplex case, the matrices \bar{F}_i and \bar{E}_i are used to map the state vector x into partition coordinates z . It can be verified that

$$\begin{aligned} z &= \bar{E}_i \bar{x} & x &\in X_i \\ z &= \mathcal{E}_i^T \bar{F}_i \bar{x} & x &\in X_i \end{aligned}$$

where \mathcal{E}_i is the vertex extraction matrix for X_i . Moreover, $\bar{F}_i = \mathcal{E}_i \bar{E}_i$ and

$$X_i = \left\{ z := \bar{E}_i x \mid z \succeq 0, \sum_{i=1}^{n+1} z_i = 1 \right\}$$

Hence, verification of the inequality (8.10), is equivalent to verification of

$$z^T T_i z \geq 0 \quad z \succeq 0. \quad (8.11)$$

with $T_i = \mathcal{E}_i^T T \mathcal{E}_i$. The constraint $\sum_i z_i = 1$ can be disregarded due to homogeneity. Problems of the type (8.11) occur, for example, in the solution to some non-standard LQG problems [52] and has attracted some

attention in the linear algebra literature. Matrices that satisfy (8.11) are called *copositive* matrices. If the inequality in (8.11) is strict for $z \neq 0$, T_i is called a *strictly copositive* matrix. For some time it was conjectured that if T_i is copositive, then it can be written as the sum of two matrices

$$T_i = P_i + U_i \tag{8.12}$$

where P_i is positive semidefinite and $U_i \succeq 0$, i.e., U_i has non-negative entries. The following result was proved in [36], see also [52].

PROPOSITION 8.7—DECOMPOSITION OF COPOSITIVE MATRICES [36]

For dimensions $n \leq 4$, every copositive matrix T_i can be decomposed in the form (8.12). However, indecomposable copositive matrices exist for $n \geq 5$. \square

Proposition 8.7 implies that for $n \leq 4$, the inequality (8.11) holds if and only if there exists a matrix $U_i \succeq 0$ such that

$$T_i - U_i \succeq 0. \tag{8.13}$$

Since \bar{E}_i is invertible, this is equivalent to

$$\bar{E}_i^T T_i \bar{E}_i - \bar{E}_i^T U_i \bar{E}_i > 0$$

and hence

$$\bar{F}_i^T T \bar{F}_i - \bar{E}_i^T U_i \bar{E}_i \geq 0.$$

This is a non-strict version of the LMI condition used in Theorem 4.1. Moreover, the matrix U_i used in this decomposition has non-negative entries ($u_{ij} = 0$ is allowed).

As this cannot be handled in a solver which only treats strict inequalities, we will extend the result to treat strict inequalities and allow the entries of U_i to be (strictly) positive.

PROPOSITION 8.8—NON-CONSERVATISM OF THE S -PROCEDURE

Let $\{X_i\}_{i \in I}$ be a simplex partition in \mathbb{R}^n with $n \leq 3$, and with constraint matrices \bar{E}_i and \bar{F}_i computed as in Section 8.1. Then

$$V(x) = \bar{x}^T \bar{F}_i^T T \bar{F}_i \bar{x} > 0 \quad \text{for } x \in X_i \setminus \{0\}, i \in I$$

if and only if there exists a matrix U_i with positive entries such that

$$\bar{F}_i^T T \bar{F}_i - \bar{E}_i^T U_i \bar{E}_i > 0.$$

□

Proof: As discussed above, $V(x) > 0$ for $x \neq 0$ is equivalent to

$$z^T T_i z > 0 \quad z \succeq 0, \forall i \in I.$$

Let O be a matrix where every entry is unity. Then, this inequality implies for each $i \in I$ there exists an $\varepsilon_i > 0$ such that

$$z^T (T_i - \varepsilon_i (I + O)) z \geq 0 \quad z \succeq 0. \quad (8.14)$$

In fact, since $z^T (O + I) z \geq 0$ on the domain of interest, ε_i can be taken as the minimal ε_i that satisfies (8.14) on the compact set

$$\{z \mid \|z\|_2 = 1, z \succeq 0\}$$

This implies that $T_i - \varepsilon_i (I + O)$ is copositive and, by Proposition 8.7, there exists $\tilde{U}_i \succeq 0$ such that

$$T_i - \tilde{U}_i - \varepsilon_i O - \varepsilon I \geq 0$$

Let $U_i = \tilde{U}_i + \varepsilon_i O$. Then $U_i \succ 0$, and

$$T_i - U_i \geq \varepsilon_i I > 0$$

Pre- and post-multiplication of \bar{E}_i and invoking the identity $\bar{E}_i^T T_i E_i = \bar{F}_i^T T \bar{F}_i$ concludes the proof.

8.3 A Matlab Toolbox

The ambition throughout this thesis has been to develop powerful analysis results that can be verified using efficient computations. An attractive feature of such an approach is that the analysis and design procedures can be packaged into software that can be used easily also by inexperienced users.

This section presents `pwL_tools`, a Matlab toolbox for analysis of piecewise linear systems. The toolbox makes it simple to define piecewise linear systems and give easy access to many of the results derived in this thesis. It also contains a simulation engine for efficient simulation of systems with discontinuous dynamics. The computations use the LMI toolbox [42].

The purpose of this presentation is not to produce a duplicate of the toolbox reference manual [46]. Rather, we aim at giving an overview of the functionality and present details only on the implementation of the simulation engine.

Toolbox Structure

A piecewise linear system has two key components; the partition of the state space into regions, and the equations describing the dynamics in each cell. This implies that a piecewise linear system can be represented as a set of ordered pairs,

$$\{(\Sigma_i, X_i)\} \quad i \in I$$

defining the local dynamics and the state-space partitioning, respectively. Any toolbox working with piecewise linear systems must have some way for representing this basic data.

The analysis procedures derived in this thesis are not restricted to any particular partition type, but they do require that certain partition properties are expressed using the constraint matrices \bar{G}_i and \bar{F}_i . In this chapter we have given procedures for computation of constraint matrices for simplex and hyperplane partitions. To apply the analysis computations to other classes of piecewise linear systems, one only needs to derive procedures for construction of constraint matrices.

Following this philosophy, the toolbox `pwl_tools` is based around a computational engine that uses a system description based on constraint matrices. In other words, the computational engine requires that both cell identifiers \bar{G}_i and continuity matrices \bar{F}_i are specified for each region. This has allowed us to separate the implementation of the analysis computations from the implementation of various user-friendly ways of specifying systems. On top of the computational engine, we have provided additions that simplify the specification of different classes of piecewise linear systems. Currently, only systems with hyperplane or simplex partitions are supported, but future extensions are easy to incorporate.

Partition Specification

The specification of constraint matrices \bar{E}_i , \bar{F}_i and \bar{G}_i can be far from easy for the inexperienced user. It is therefore desirable to relieve him or her from this task. The toolbox supports easy construction of simplex and hyperplane partitions. The constraint matrices are computed automatically using the manipulations described in Section 8.1

Table 8.1 summarizes the commands for specifying hyperplane partitions. The command `setpart` initializes a new partition, and should be issued prior to defining the partition components. In order to indicate the type of partition, `setpart` takes the argument 'h' for hyperplane partitions and 's' for simplex partitions. The commands `addhnp` and `addati` define generating hyperplanes and affine dynamics respectively. Both commands return a positive integer that serves as identifier for later reference. Cells are subsequently defined using the command `addhcell`, which

Command	Description
setpart	Initialize partition data structure
addhp	Add hyperplane
addati	Specify affine dynamics
addhcell	Define hyperplane cell
getpart	Retrieve partition data structure

Table 8.1 Commands for defining hyperplane partitions.

takes two arguments. The first argument specifies the bounding hyperplanes (using their identifiers returned by `addhp`), and the second argument specifies the dynamics valid in the region (using the identifiers returned by `addati`). The sign of the hyperplane reference indicates on “what side” of the hyperplane the cell is located. To be more precise, let r_k be the reference for hyperplane \mathcal{H}_k . Then, specifying $+r_k$ in the list of bounding hyperplanes indicates that $X_i \subseteq \mathcal{H}_k^+$, while specifying $-r_i$ indicates that $X_i \subseteq \mathcal{H}_k^-$.

The command `getpart` returns a data structure that describes the partition. Finally, the command `part2pwl` computes the data required by the computational engine of `pwl_tools`. To illustrate the use of the commands, we return to the linear system with actuator saturation in Example 2.1.

EXAMPLE 8.2—DESCRIBING THE SATURATED SYSTEM

The piecewise linear system induced by the actuator saturation in Example 2.1 can be described by the following lines of Matlab code.

```
%-- Initialize partition
setpart('h');
%-- Specify hyperplanes
n_sat=addhp([-k -1]);
p_sat=addhp([k -1]);
%-- Define local dynamics
dnsat=addati(A,-b);
dlin =addati(A+b*k');
dpsat=addati(A,b);
%-- Introduce cells
Xn=addhcell([n_sat],dnsat);
Xl=addhcell([-n_sat -p_sat],dlin);
Xp=addhcell([p_sat],dpsat);
%-- Retrieve partition data
part=getpart;
```

□

Command	Description
setpart	Initialize partition data structure
addvtx	Add vertex
addray	Add ray
addati	Specify affine dynamics
addvcell	Define vertex cell
getpart	Retrieve partition data structure

Table 8.2 Commands for defining simplex partitions.

The specification of a simplex partition is very similar to the definition of a hyperplane partition. The main difference is that cells are now defined by vertices (“points”) and rays (“directions”) rather than the equations for its bounding hyperplanes. The commands for composing simplex partitions are shown in Table 8.2.

A new simplex partition is initialized by the command `setpart('s')`. Vertices and rays are defined by the commands `addvtx` and `addray`. Both commands return an identifier for later reference. Similar to the hyperplane case, dynamics are defined by the command `addati`. The cells of the partition are defined by the command `addvcell` which takes three arguments. The first two arguments are lists of vertex and ray references respectively, while the last argument specifies the dynamics valid within the region. The total number of vertex and ray references should sum to $n + 1$, of which at least one should be a vertex. Once all cells are defined, the command `getpart` retrieves a data structure describing the partition, and the command `part2pwl` transform this information into the data required by `pwl_tools`. We apply the commands to Example 4.3.

EXAMPLE 8.3—DESCRIBING SIMPLEX PARTITIONS

Consider the system from Example 4.3. This system used a partition with four cells that are a rotation of the four quadrants in \mathbb{R}^2 . The interpretation of this partition as a simplex partition is shown in Figure 8.5. The partition has one vertex at the origin and four rays that define the directions of the cell boundaries. The commands in Table 8.2 makes it easy to define the system for use in `pwl_tools`. The following lines of code performs the necessary steps.

```
%-- Initialize simplex partition
setpart('s');
%-- Define vertices and rays
```

```

v0=addvtx([0 0]);
r1=addray([-1 -1]);
r2=addray([-1 1]);
r3=addray([1 1]);
r4=addray([1 -1]);
%-- Set up dynamics
d1 = addati(A1);
d2 = addati(A2);
%-- Define cells
X1 = addvcell([v0],[r1 r2],d1);
X2 = addvcell([v0],[r2 r3],d2);
X3 = addvcell([v0],[r3 r4],d1);
X4 = addvcell([v0],[r4 r1],d2);
%-- Retrieve partition data structure
part = getpart;
%-- Transform into pwltools data structure
pwlst=part2pwl(part);

```

□

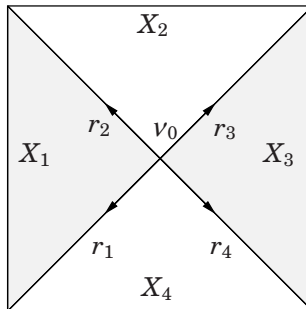

Figure 8.5 Data needed for specifying the simplex partition in Example 8.3.

Once a pwl object that describes the system has been obtained, many computations derived in this thesis can be used for system analysis and controller design.

Structural Analysis

The structural analysis described in Chapter 3 is supported through the commands in Table 8.3. The command `findeqs` searches uses the computations of Proposition 3.1 to compute the equilibrium points of the system. The command `dcgain` allows for the static analysis described in Section 3.1. Sliding modes on cell faces can be detected by application of `findsm`, which implements Proposition 3.4.

Command	Description
findeqs	Find Equilibrium Points
dcgain	DC gain analysis
findsm	Find attractive sliding modes

Table 8.3 Commands for structural analysis.

Command	Description
qstab	Quadratic stability analysis
pqstab	Piecewise quadratic stability analysis
pqstabs	D.o. accounting for sliding modes

Table 8.4 Commands for Lyapunov function computations.

Lyapunov Function Computations

The commands provided for stability analysis are shown in Table 8.4. Here `pqstab` denotes the search for a piecewise quadratic Lyapunov function according to Theorem 4.1. If stability can be established, the command returns the matrices \bar{P}_i that define the computed Lyapunov function. The command `qstab` performs the search for a globally quadratic Lyapunov function using S -procedure. The results of `pqstab` are only valid if the system does not possess attractive sliding modes. The command `pqstabs` is modified according to the discussion in Section 4.11 to assure stability also in the presence of sliding modes.

EXAMPLE 8.4—FLOWER SYSTEM — STABILITY ANALYSIS

The tools can be used to easily verify stability of the flower system of Example 4.3. The marker `>>` symbolizes the prompt in the Matlab command window. Lines that do not start with this marker indicate information displayed by the commands.

```
>> %-- Search for sliding modes
>> findsm(pwlsys);
There are no sliding modes.
>> %-- Since there are no sliding modes, use pqstab
>> pqstab(pwlsys);
Lyapunov function found.
```

□

Command	Description
iogain	Computation of induced \mathcal{L}_2 gain
pqobserv	Output energy estimation

Table 8.5 Commands for system analysis.

Command	Description
optcstlb	Estimate minimal achievable cost for pwlQG problem
pwlctrl	Derive piecewise linear controller based on optcstlb
optcstub	Estimate pwlQ cost achieved by pwlctrl

Table 8.6 Commands for controller design.

System Analysis

The commands for system analysis are summarized in Table 8.5.

The command `iogain` computes an upper bound on the \mathcal{L}_2 -induced gain of a pwl system as described in Theorem 5.1. The command `pqobserv` is an application of Theorem 5.2 to the computation of upper and lower bounds on the integral of the output energy obtained from a given initial state.

Controller Design

The piecewise linear quadratic optimal control is supported through the three commands summarized in Table 8.6.

A lower bound on the achievable cost is computed by `optcstlb`. The command `pwlctrl` creates a pwl controller based on the results from `optcstlb`. The command returns the feedback gains for each region. The command `optcstub` estimates the cost achieved by this control law, hence providing an upper bound on the optimal cost.

Simulation

Simulation is one of the most important tools for evaluating new control strategies, in academia as well as in industry. Despite the strong development in general-purpose simulation environments during the last 30 years, the support for event detection is a quite recent addition to most simulation packages. Simulation of systems with switching and discontinuous dynamics is still poorly supported. Included in the toolbox is therefore a simulation engine that allows efficient simulation of piecewise linear systems with discontinuous dynamics, see Table 8.7.

In the context of piecewise linear systems, problems may occur when

Command	Description
<code>pwlsim</code>	Simulate pwl system with sliding modes

Table 8.7 The command `pwlsim` simulates systems with sliding modes.

the vector field is discontinuous across cell boundaries. If the vector field in several neighboring cells point towards their common boundary, a unique continuation of trajectories may not be possible. This situation causes most simulators to simply ‘get stuck’. As was discussed in Section 4.11, it may still be possible to define meaningful solution concepts in these situations. One such concept was Filippov’s convex definition that defines solutions by averaging the dynamics in the neighboring cells. This averaging gives rise to a sliding motion confined to the switching surface. The command `pwlsim` detects sliding mode situations, and simulates the sliding mode dynamics given by Filippov’s solution. This prevents the simulator to get stuck, and systems with sliding modes can be simulated with high precision and efficiency.

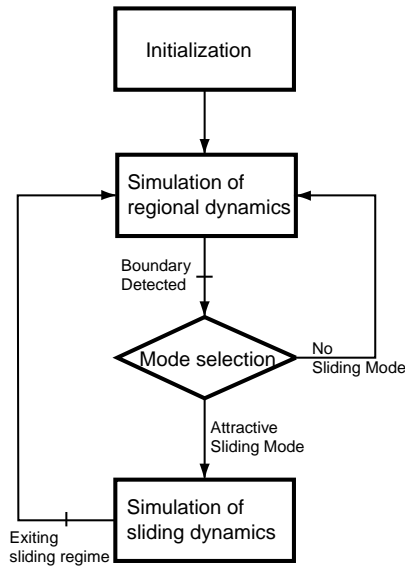

Figure 8.6 Schematic description of simulation engine.

A schematic diagram of the simulation algorithm is shown in Figure 8.6. The first step in the simulation is to perform a cell identification,

in order to detect to what cell X_i a given initial value belongs. The regional dynamics is then simulated using the ODE-solvers in Matlab,

$$\dot{x} = A_i x + a_i \quad \text{as long as } \bar{G}_i \bar{x} \succ 0. \quad (8.15)$$

The ODE routines support event detection, and as soon as equality is attained for some element in the vector $\bar{G}_i \bar{x}$, the simulation of the regional dynamics is terminated. This means that the state belongs to a cell boundary.

When the state enters a cell boundary, the simulation engine checks the conditions for sliding motion. Let the cell boundary be given by

$$\partial X_i = \{x \mid h_i^T x + g_i = 0\}.$$

Sliding motion is possible using Filippov's convex definition if there exists positive scalars $\alpha_k \geq 0$ with $\sum_k \alpha_k = 1$ such that

$$\sum_k \alpha_k (h_i^T A_k x + h_i^T a_k) = 0 \quad \text{for all } k \text{ with } x \in X_k.$$

As long as the conditions for sliding motion are fulfilled, the simulator uses the resulting dynamics

$$\dot{x} = \sum_k \alpha_k (A_k x + a_k) \quad \text{for all } k \in X_i.$$

When the state exits the sliding regime, the simulation engine returns to the simulation of regional dynamics.

In the case of ambiguities, the simulator stops and reports uniqueness problems. Such situations occur for example when one tries to simulate a system from an initial state on a boundary where the neighboring vector fields are all outward. Another situation that presents non-uniqueness problems is when the state belongs to the intersection of several cell boundaries. If sliding motion is possible on an intersection of cell boundaries, the simulator also aborts. The reason for this is that in these situations Filippov's definition may not be enough to produce a unique velocity for the sliding motion, see [91, 125].

An alternative solution for simulation with sliding on intersecting hyperplanes is to simply introduce a space hysteresis in the cell definitions. Rather than simulating the regional dynamics until a cell boundary is hit, we proceed a small distance before switching cell. This can be obtained by replacing the condition $\bar{G}_i \succ 0$ in (8.15) by the condition $\bar{G}_i \succ \varepsilon \mathbf{1}$ where $\mathbf{1}$ denotes a vector of ones of appropriate dimension, and $\varepsilon > 0$.

We apply the first approach to the simulation of a relay system with a sliding mode, cf. [57, 5].

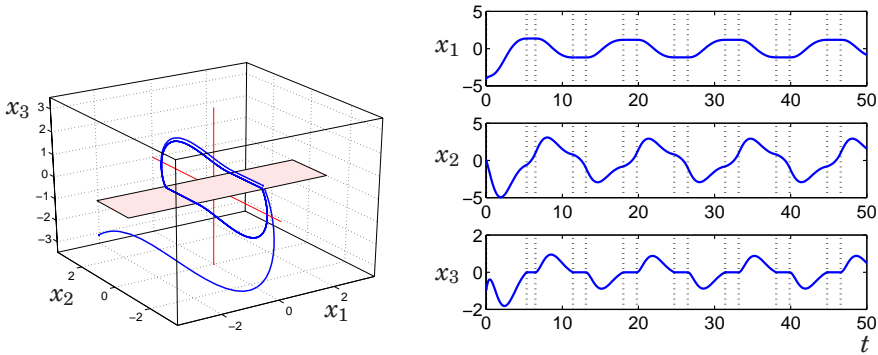

Figure 8.7 Limit cycle with sliding trajectory. The vertical dashed lines in the right part indicate time instances for the mode selection.

EXAMPLE 8.5—SIMULATION OF SLIDING MODE SYSTEM

Consider the following linear system under relay feedback

$$\dot{x} = \begin{bmatrix} 0 & 0 & -1 \\ 1 & 0 & -2 \\ 0 & 1 & -2 \end{bmatrix} x - \begin{bmatrix} 0 \\ -1 \\ 1 \end{bmatrix} \text{sign}(y)$$

$$y = [0 \quad 0 \quad 1]x.$$

This system has a limit cycle with an attractive sliding mode and requires accurate simulation. Sliding mode detection and simulation can be carried out in `pw1_tools` with the following commands.

```
>> % Search for sliding modes
>> findsm(pwlsys);
Sliding mode detected on boundary between cell 1 and 2.
>> % Simulate the system
>> x0 = [1 -1 0]';
>> [t, x, te] = pwlsim(pwlsys, x0, [0 20]);
```

The above code establishes that the system exhibits a sliding mode on the switching surface. Simulating the system using the command `pwlsim`, one can see how the system tends to a limit cycle with sliding mode, see Figure 8.7. □

8.4 Comments and References

Constraint Matrices and Canonical Representations

Many important theoretical problems remain open considering the constraint matrices. Can the suggested parameterization represent all continuous and piecewise quadratic Lyapunov functions on a given partition? Is the parameterization close to being canonical, or is it possible to eliminate further parameters? Related questions have been raised about the canonical piecewise linear models discussed in Chapter 2, see [77, 71, 86].

9

Concluding Remarks

This thesis has dealt with analysis of piecewise linear dynamical systems. The developments contain two important ingredients; a powerful systems class and a novel toolset for efficient Lyapunov function construction. The thesis has taken the full route from an initial idea, via theoretical developments, to a methodology that can be applied to relevant engineering problems. The results are made easily available through through a Matlab toolbox that implements many of the results derived in the thesis. Several new results were given and many interesting and important problems remain open. In this sense, this thesis has taken some first steps towards a useful Lyapunov-based theory for piecewise linear systems. In these concluding remarks, we summarize the contributions and give some suggestions for future research.

Summary of Contributions

Piecewise linear systems and piecewise quadratic Lyapunov functions are natural extensions of linear systems and quadratic Lyapunov functions. Piecewise linear systems have been used extensively in circuit theory. The main applications have been efficient circuit simulation and static analysis, while the more complicated dynamical properties appears to have been largely unattended. This thesis focuses on the dynamical properties of piecewise linear systems.

Piecewise Linear Dynamic Systems

Piecewise linear systems is a natural extension of linear systems. Many of the most common nonlinearities control systems, such as saturations and relays, are piecewise linear. This thesis has tried to take a broader view. We have given a simple matrix parameterization of polyhedral piecewise linear systems which is convenient for computations. The polyhedral

piecewise linear systems are natural in the analysis of systems with saturations and selectors, but are also useful for approximation of smooth nonlinear systems. Uncertainty plays a central role in the analysis of feedback systems, and the possibility to account for uncertainties is very useful in system analysis. We showed how the standard uncertainty models for linear systems can be extended in a natural way to piecewise linear systems. An important idea was the use of piecewise linear differential inclusions. They allow piecewise linear sector bounds on nonlinearities, and arbitrarily precise bounds can be achieved by partition refinements. This makes piecewise linear systems an interesting system class for analysis of smooth nonlinear systems, and they allow a lot of freedom in the trade-off between fidelity and complexity in the modeling process.

Non-quadratic Lyapunov Functions via Convex Optimization

The main contribution of this thesis is the LMI-based computations of piecewise quadratic Lyapunov functions. It is a novel idea that can be implemented using very efficient computations. The approach improves the freedom compared to the Popov criterion, but its main attraction is that it easily deals with multi-variable nonlinearities. The flexibility of an initial Lyapunov function candidate can be improved via partition refinements. This makes the piecewise quadratic Lyapunov functions a very powerful Lyapunov function class.

By restricting the format for piecewise quadratic Lyapunov functions we obtained a parameterization of Lyapunov functions that are continuous and piecewise linear. Piecewise linear Lyapunov functions can be computed via linear programming. This has some advantages compared to the LMI-based computations used in the construction of piecewise quadratic Lyapunov functions. An important aspect of this development is that the common parameterization establishes a unifying view of quadratic, polytopic, piecewise linear and piecewise quadratic Lyapunov functions. The function classes have different degrees of flexibility and require different amounts of memory for their representation. They also require different amount of computations in the stability analysis. By having one format for several classes of Lyapunov functions, it is simple to move from one function class to the other in order to find the most appropriate Lyapunov function candidate for a certain problem.

Emphasis was put on making the computations efficient. By a slight reformulation of the analysis conditions, the basic computations could be simplified considerably, essentially without introducing conservatism. The use of ellipsoidal cell boundings allowed even more efficient computations, but introduces some conservatism in the analysis.

Results for analysis of systems with attractive sliding modes were also given. A simple way for performing local analysis and convergence to a

set was derived. This has a direct application to estimation of stability regions, but may also be useful in limit cycle computations.

Dissipativity Analysis using Piecewise Quadratic Storage Functions

The Lyapunov functions were applied to dissipativity analysis. We gave an approach for dissipativity analysis based on piecewise quadratic storage functions. By use of upper and lower bounds on the estimated energy quantities, it was shown how partition refinements could give improved estimates. The dissipativity analysis also opens up possibilities to combine the piecewise linear analysis with analysis done by other methods. The ideas were illustrated on small gain analysis of a piecewise linear system with dynamic uncertainty.

Piecewise Linear-Quadratic Optimal Control

The piecewise quadratic functions were also used in solving optimal control problems via convex optimization. In this way, feedback control laws were obtained using very simple methods. The idea was only taken a small step in this thesis, and further developments are necessary in order to make this approach a useful design methodology.

Fuzzy Systems, Hybrid Systems and Smooth Nonlinear Systems

The basic results were extended in several useful ways, providing new analysis techniques for fuzzy systems, hybrid systems and smooth nonlinear systems.

The first extension was to fuzzy systems. An important class of fuzzy systems are close to being piecewise linear, and we showed how these systems could be described by piecewise linear differential inclusions. Given a system model in terms of fuzzy logic-based rules, a corresponding uncertain piecewise linear model can be derived using a simple procedure. This allowed the piecewise quadratic Lyapunov function computations to be tailored to fuzzy systems, hence providing a novel and powerful toolset for analysis of such systems.

A second extension was to hybrid systems. Hybrid systems have attracted a large interest in the control community over the last few years, and many intriguing questions remain to be answered. We showed how a class of hybrid systems could be analyzed via convex optimization. The analysis uses Lyapunov functions that have a discontinuous dependence on the discrete state.

The third extension was to smooth nonlinear systems. Piecewise linear systems can approximate smooth systems to arbitrary precision. The same statement holds true for the piecewise linear and piecewise quadratic Lyapunov functions suggested in this thesis. It is therefore natural to

try to use the piecewise linear approach to analysis of smooth systems. We showed approximation errors could be taken into account explicitly, providing formal results for smooth systems based on piecewise linear analysis.

Partition refinements play an important role throughout this thesis. They increase the accuracy in piecewise linear approximations and improve the flexibility of the Lyapunov function candidates. A novel approach for automated partition refinements was proposed, based on linear programming duality.

Computational Aspects and Toolbox Implementation

Computational issues were also treated. Explicit formulas for covering ellipsoids of minimal volume were given for simplex and hyper-rectangular cells. This makes it easy and computationally efficient to use ellipsoidal cell boundings in the analysis, and has also a theoretical interest in itself. We provided some insight in the S -procedure, proving that for some partition types, the polytopic S -procedure is always less conservative than the quadratic S -procedure. We also proved non-conservatism of the S -procedure for simplex partitions in dimensions up to 3.

Finally, we presented a Matlab toolbox that makes it easy to describe, simulate and analyze piecewise linear systems. It gives easy access to many of the results from the thesis and provides a simulation engine for efficient simulation of piecewise linear systems with sliding modes.

Open Problems and Ideas for Future Research

Numerical analysis and design of control systems is only in its infancy. The progress in hardware and software opens many possibilities. In this thesis, we have shown how convex optimization can be used to analysis of nonlinear dynamical systems. The results have direct applications, and can be extended in many promising ways. In this section, we point out some open problems and give ideas for future research.

The matrix representation for piecewise linear systems was derived to be convenient in computations. A drawback with this representation is that it requires a large amount of memory for its representation. As discussed in Chapter 2, model representations that are much more memory efficient can be derived for piecewise linear systems with continuous vector fields. The implicit piecewise linear representation was shown to be closely related to our model. Is it possible to derive LMI conditions for piecewise quadratic stability that makes efficient use of this model?

Partition refinements are very useful to increase the flexibility of the Lyapunov function candidate. We gave a simple procedure for automated

partition refinements based on linear programming duality. The developments were based on a large portion of heuristics, and many issues are left open. Is this partition refinement strategy the best possible? Can convergence be proven in a formal way? The extension to the LMI case would also be very interesting.

It would be very useful to be able to analyze piecewise linear systems that are interconnected with nonlinearities described by integral quadratic constraints. This would, for example, allow less conservative analysis of piecewise linear systems with time delays. It appears to be fruitful to consider an approach along the lines of the Lyapunov technique presented in [70], Section 1.7.

The idea of solving optimal control problems via convex optimization and the Hamilton-Jacobi-Bellman inequality is very promising. Advances in hardware and software now allows design of feedback laws based on optimality considerations using convex optimization. This theme has only be touched upon in this thesis. Several interesting extensions along these lines have been given in [118].

There is currently a large interest in fuzzy control and hybrid control systems. We have extended the piecewise quadratic Lyapunov functions to apply also to these cases. The piecewise linear techniques Lyapunov functions could be extended similarly, resulting in potentially very useful results.

Many system theoretic issues related to well-posedness of solutions, observability and controllability are left open. These are important components of a more complete theory for piecewise linear dynamical systems.

Finally, the majority of the problems treated in this thesis are concerned with properties of equilibria. Tracking problems have not been considered. Extensions to tracking problems would be of great practical relevance.

A

Proofs

A.1 Proofs for Chapter 2

Proof of Proposition 2.1

We consider two polyhedral piecewise linear systems

$$\begin{aligned} \Sigma_1 : \begin{cases} \dot{x} = A_i x + a_i + B_i u_1 \\ y_1 = C_i x + c_i + D_i u_1 \end{cases} & x \in X_i \\ \Sigma_2 : \begin{cases} \dot{z} = A_j z + a_j + B_j u_2 \\ y_2 = C_j z + c_j + D_j u_2 \end{cases} & z \in Z_j \end{aligned}$$

where X_i and Z_j denote polyhedral sets, represented as

$$\begin{aligned} X_i &= \{x \mid G_i x + g_i \succeq 0\} \\ Z_j &= \{z \mid G_j z + g_j \succeq 0\} \end{aligned}$$

Throughout, this proof we will let $x \in X_i$ and $z \in Z_j$. This is a polyhedral constraint in x and z , which can be represented as

$$\tilde{X}_{ij} = \left\{ \begin{bmatrix} x \\ z \\ 1 \end{bmatrix} \mid \begin{bmatrix} G_i & 0 & g_i \\ 0 & G_j & g_j \end{bmatrix} \begin{bmatrix} x \\ z \\ 1 \end{bmatrix} := \tilde{G}_{ij} \begin{bmatrix} x \\ z \\ 1 \end{bmatrix} \succeq 0 \right\}$$

The partition of the interconnected system is made up from cells derived for all i, j such that $x \in X_i$, $z \in Z_j$, and has thus $i \times j$ cells.

Appendix A. Proofs

In series connection, we let

$$u_2 = y_1$$

and obtain

$$\begin{aligned} \begin{bmatrix} \dot{x} \\ \dot{z} \end{bmatrix} &= \begin{bmatrix} A_i & 0 & a_i \\ B_j C_i & A_j & a_j + B_j c_i \end{bmatrix} \begin{bmatrix} x \\ z \\ 1 \end{bmatrix} + \begin{bmatrix} B_i \\ B_j D_i \end{bmatrix} u_1 \\ y_2 &= \begin{bmatrix} D_j C_i & C_j & c_j + D_j c_i \end{bmatrix} \begin{bmatrix} x \\ z \\ 1 \end{bmatrix} + D_j D_i u_1 \end{aligned}$$

In parallel connection we let

$$u_1 = u_2$$

and obtain

$$\begin{aligned} \begin{bmatrix} \dot{x} \\ \dot{z} \end{bmatrix} &= \begin{bmatrix} A_i & 0 & a_i \\ 0 & A_j & a_j \end{bmatrix} \begin{bmatrix} x \\ z \\ 1 \end{bmatrix} + \begin{bmatrix} B_i \\ B_j \end{bmatrix} u_1 \\ \begin{bmatrix} y_1 \\ y_2 \end{bmatrix} &= \begin{bmatrix} C_i & 0 & c_i \\ 0 & C_j & c_j \end{bmatrix} \begin{bmatrix} x \\ z \\ 1 \end{bmatrix} + \begin{bmatrix} D_i \\ D_j \end{bmatrix} u_1 \end{aligned}$$

For the feedback interconnection, we set

$$u_1 = y_2 + w_1, \quad u_2 = y_1 + w_2$$

and assume $D_j = 0$ to avoid algebraic loops. We get

$$\begin{aligned} \begin{bmatrix} \dot{x} \\ \dot{z} \end{bmatrix} &= \begin{bmatrix} A_i + B_i C_j & 0 & a_i + B_i c_j \\ B_j C_i & A_j + B_j D_i c_j & a_j + B_j c_i + B_j D_i c_j \end{bmatrix} \begin{bmatrix} x \\ z \\ 1 \end{bmatrix} + \\ &+ \begin{bmatrix} B_i & 0 \\ 0 & B_j \end{bmatrix} \begin{bmatrix} w_1 \\ w_2 \end{bmatrix} \\ \begin{bmatrix} y_1 \\ y_2 \end{bmatrix} &= \begin{bmatrix} C_i & D_i C_j & c_i + D_i c_j \\ 0 & C_j & c_j \end{bmatrix} \begin{bmatrix} x \\ z \\ 1 \end{bmatrix} + \begin{bmatrix} D_i \\ 0 \end{bmatrix} w_1 \end{aligned}$$

A.2 Proofs for Chapter 3

Proof of Proposition 3.2

Consider the system

$$\dot{x} = A_i(x - x_i^*) \quad \text{for } \{x \mid \bar{G}_i \bar{x} \geq 0\}$$

Let $\lambda_{ik} > 0$ be a real eigenvalue of A_i with corresponding eigenvector v_{ik} . Hence, if we pick $x(0) = x_i^* + \alpha v_{ik} \in X_i$ for some $\alpha > 0$, then

$$x(t) - x_i^* = (e^{\lambda_{ik}(t-t_0)} + \alpha)v_{ik} \quad \text{for all } t \geq 0.$$

Such an α exists by the assumptions of Proposition 3.2. It remains to show that the solution generated in this way remains in X_i , *i.e.*, that

$$\begin{aligned} \bar{G}_i \bar{x}(t) &= G_i \left(x_i^* + (e^{\lambda_{ik}(t-t_0)} + \alpha)v_{ik} \right) + g_i = \\ &= (e^{\lambda_{ik}(t-t_0)} + \alpha)G_i v_{ik} + G_i x_i^* + g_i \geq 0 \end{aligned}$$

for all $t \geq 0$. Since $x(t)$ evolves along a line, and since the cells are convex, it is sufficient to check that this condition is satisfied as $t \rightarrow \infty$. This requires that $G_i v_{ik} \geq 0$, and that whenever an entry of $G_i v_{ik}$ is zero, the corresponding entry of $G_i x_i^* + g_i$ is non-negative. This proves the statement.

A.3 Proofs for Chapter 4

Proof of Proposition 4.2

Consider the Lyapunov function candidate $V(x) = x^T P x$. Since P is positive definite, $V(x)$ can be bounded in the sense of Lemma 4.1, Equation (4.2). A solution to the strict inequalities (4.8) implies the existence of a $\gamma > 0$ such that

$$A_i^T P + P A_i + \gamma I \leq 0 \quad i = 1, \dots, L.$$

Now, consider the representation (4.6) of the differential inclusion (4.5). For the suggested Lyapunov function, $V(x) = x^T P x$, we have

$$\begin{aligned} \frac{d}{dt} V(x(t)) &= \sum_{i=1}^L \lambda_i(t) x(t)^T (A_i^T P + P A_i) x(t) \leq \\ &\leq \sum_i^L \lambda_i(t) (-\gamma \|x(t)\|_2^2) = -\gamma \|x(t)\|_2^2. \end{aligned}$$

The desired result now follows from Lemma 4.1 by letting the vector norm $\|\cdot\|$ be the two-norm $\|\cdot\|_2$ and by setting $p = 2$.

Proof of Lemma 4.3

Consider a cell X_i with cell identifier \bar{G}_i , *i.e.*,

$$X_i = \left\{ x \mid \bar{G}_i \bar{x} = [G_i \quad g_i] \begin{bmatrix} x \\ 1 \end{bmatrix} \succeq 0 \right\}.$$

We first prove that the constructed cell boundings have the zero interpolation property. It then suffices to consider $i \in I_0$. Removing all rows of \bar{G}_i whose last entry is nonzero gives a cell bounding on the form

$$\bar{E}_i = [G_i^T \quad 0].$$

Hence, matrices \bar{E}_i computed in this way have the zero interpolation property.

To prove the second claim we proceed in two steps. First, let $i \in I_1$. Adding the suggested row to the cell identifiers is equivalent to adding the constraint $1 \geq 0$ to the cell definitions. This constraint is satisfied for all x , and the assertion follows. Now, let $i \in I_0$. Then $V(x)$ is quadratic,

$$V(x) = x^T P_i x \quad \text{for } x \in X_i$$

for some $P_i \in \mathbb{R}^{n \times n}$. The suggested deletion process eliminates all halfspaces with nonzero offset terms, *i.e.*, halfspaces

$$\mathcal{H}_{ik} = \{x \mid a_{ik}^T x + b_{ik} \geq 0\}$$

with $b_{ik} > 0$ from the analysis domain. We claim that this does not change the result of the analysis. To see this, note that the intersection of such halfspaces always contains a neighborhood around the origin. Due to homogeneity, if

$$V(x_0) = x_0^T P x_0 > 0$$

for some x_0 , then $V(t \cdot x_0) > 0$ for all $t \neq 0$. Hence, if $V(x_0) > 0$ for $x_0 \in \cap_k \mathcal{H}_{ik}$, then $V(x) > 0$ for all x , and the constraints can be removed without altering the analysis. This concludes the proof.

Proof of Lemma 4.7

We will first prove the following lemma.

LEMMA A.1

The following statements are equivalent

1. $p^T x > 0$ for all x such that $Ex \geq 0$ and $x \neq 0$.
2. $p \in \text{Int}(\mathcal{K}_E)$ where $\mathcal{K}_E = \{y \mid y = E^T u, u \geq 0\}$
3. There exists a vector $u \succ 0$ such that $p - E^T u = 0$.

□

Proof: Let \mathcal{K}_E^o denote the polar cone of \mathcal{K}_E , i.e.,

$$\mathcal{K}_E^o = \{x \mid x^T y \leq 0, \forall y \in \mathcal{K}_E\}$$

and let \mathcal{B} denote the ball $\mathcal{B} = \{x \mid \|x\| = 1\}$ Then, equivalence of Claim 1 and Claim 2 follows from

$$\begin{aligned} 1 &\Leftrightarrow p^T x > 0 && \forall x \in -\mathcal{K}_E^o \setminus \{0\} \\ &\Leftrightarrow p^T \frac{x}{\|x\|} && \forall x \in -\mathcal{K}_E^o \setminus \{0\} \\ &\Leftrightarrow p^T x > 0 && \forall x \in -\mathcal{K}_E^o \cap \mathcal{B} \\ &\Leftrightarrow \exists \varepsilon > 0, p^T x > \varepsilon && \forall x \in -\mathcal{K}_E^o \cap \mathcal{B} \\ &\Leftrightarrow p^T x \geq \varepsilon \|x\| && \forall x \in -\mathcal{K}_E^o \\ &\Leftrightarrow p^T x \geq \varepsilon y^T x && \forall x \in -\mathcal{K}_E^o, \forall y \in \mathcal{B} \\ &\Leftrightarrow (p - \varepsilon y)^T x \geq 0 && \forall x \in -\mathcal{K}_E^o, \forall y \in \mathcal{B} \end{aligned}$$

Hence, by Farkas' lemma, $p - \varepsilon y \in \mathcal{K}_E \forall y \in \mathcal{B}$ which implies

$$\Leftrightarrow p \in \text{Int}(\mathcal{K}_E) \qquad \Leftrightarrow 2.$$

We prove equivalence of Claim 2 and Claim 3 in two steps. First

$$2 \Leftrightarrow p - \varepsilon y \in \mathcal{K}_E, \qquad \forall y \in \mathcal{B}$$

Let $\mathbf{1} = [1 \ \dots \ 1]^T$. Then, the statement above implies

$$\begin{aligned} &\Rightarrow p - \varepsilon \frac{E^T \mathbf{1}}{\|E^T \mathbf{1}\|} \in \mathcal{K}_E \\ &\Leftrightarrow \exists u_0 \geq 0, p - \varepsilon \frac{E^T \mathbf{1}}{\|E^T \mathbf{1}\|} = E^T u_0 \\ &\Leftrightarrow p = E^T \left(u_0 + \varepsilon \frac{\mathbf{1}}{\|E^T \mathbf{1}\|} \right) := E^T u \Leftrightarrow 3 \end{aligned}$$

Appendix A. Proofs

where $u \succ 0$. Hence Claim 2 implies Claim 3. Conversely,

$$\begin{aligned}
 3 &\Leftrightarrow p = E^T u, u \succ 0 \\
 &\Leftrightarrow \exists \varepsilon > 0, u + \varepsilon v \succeq 0 && \forall v \in \mathcal{B} \\
 &\Leftrightarrow \exists \varepsilon > 0, p + \varepsilon E^T v \in \mathcal{K}_E \\
 &\Leftrightarrow p + \varepsilon E^T v \in \mathcal{K}_E
 \end{aligned}$$

and, if E has full column rank,

$$\Rightarrow p \in \text{Int}(\mathcal{K}_E) \Leftrightarrow 2$$

We can now proceed to prove Lemma 4.7. Note that Claim 2 implies Claim 1 trivially, since

$$p^T x = u^T E x \geq 0$$

for $u \succ 0$ and all x with $E x \neq 0$.

Consider the converse statement. If E has full column rank, then $1 \Rightarrow 2$ by Lemma A.1. When E does not have full column rank then we can, without loss of generality, assume that E is on the form

$$E = [E_+ \quad 0].$$

where E_+ has full column rank. Now, Claim 1 implies that p must be on the form

$$p = [p_+^T \quad 0]^T.$$

Let $x = [x_+ \quad x_0]$. Then, we have

$$p_+^T x_+ > 0 \quad \forall x_+ \text{ with } E_+ x_+ \geq 0, x_+ \neq 0$$

and, by Lemma A.1, there exists $u_+ \succ 0$ such that

$$p_+ - E_+^T u_+ = 0$$

Hence Claim 2 follows with $u = [u_+^T \quad u_0^T]^T \succ 0$, with arbitrary but $u_0 \succ 0$.

A.4 Proofs for Chapter 8

Proof of Proposition 8.4

LEMMA A.2

Let $x, z \in \mathbb{R}^n$ and let $x = \bar{T}\bar{z} = Tz + t$ be an affine bijective map. If

$$\mathcal{E}(\bar{S}_i) = \{z \mid \bar{z}^T \bar{S}_i \bar{z} \leq 1\}$$

is the minimal volume ellipsoid that contains the set Z_i , then

$$\mathcal{E}(\bar{T}^T \bar{S}_i \bar{T}) = \{x \mid \bar{x}^T \bar{T}^T \bar{S}_i \bar{T} \bar{x} \leq 1\}$$

is the minimum volume ellipsoid that contains the set

$$X_i = \{x = \bar{T}\bar{z} \mid z \in Z_i\}.$$

□

Proof: Since the mapping $x = \bar{T}\bar{z}$, is affine and bijective,

$$\mathcal{E}(\bar{S}_i) \supseteq Z_i \Leftrightarrow \mathcal{E}(\bar{T}^T \bar{S}_i \bar{T}) \supseteq X_i.$$

Moreover, if $\mathcal{E}(\bar{S}_i)$ describes an ellipsoid, it can be written as

$$\mathcal{E}(\bar{S}_i) = \{z \mid (z - z_0)^T P^{-1} (z - z_0) \leq 1\}$$

for some x_0 and some $P = P^T > 0$. The volume of $\mathcal{E}(\bar{S}_i)$ is then

$$\text{vol}(\mathcal{E}(\bar{S}_i)) = \sqrt{\det P} \cdot V_n$$

where V_n denotes the volume of a unit sphere in \mathbb{R}^n . Let

$$\bar{T} = [T \quad \tau].$$

Then, the volume of the transformed ellipsoid is

$$\text{vol}(\mathcal{E}(\bar{T}^T \bar{S}_i \bar{T})) = \det T \sqrt{\det P} \cdot V_n.$$

Hence, for a given mapping \bar{T} the volume is proportional to $\det P$, and the circumscribing ellipsoid of minimal volume can be obtained by optimizing the volume of either $\mathcal{E}(\bar{S}_i)$ or $\mathcal{E}(\bar{T}^T \bar{S}_i \bar{T})$.

Appendix A. Proofs

LEMMA A.3

The minimum volume ellipsoid containing the standard simplex,

$$X_i = \{x \in \mathbb{R}^{n+1} \mid x_k \geq 0, \sum_{k=1}^{n+1} x_k = 1\}$$

is the ball

$$\mathcal{E}^* = \{x \mid x^T x \leq 1, \sum_{k=1}^{n+1} x_k = 1\} \quad (\text{A.1})$$

□

Proof See [61].

Note that both X_i and \mathcal{E}^* are affine sets in \mathbb{R}^{n+1} , *i.e.*, they live on a constraint hyperplane $\{x \mid \sum_{k=1}^{n+1} x_k = 1\}$. We note that Lemma A.2 can be applied also to affine mappings that maps points in \mathbb{R}^n onto the affine set in \mathbb{R}^{n+1} defined by the constraint hyperplane.

PROOF A.1—PROOF OF PROPOSITION 8.4

Proposition 8.4 now follows trivially, since the map $x \mapsto z$ defined by

$$z = \bar{G}_i \bar{x}$$

is a bijective affine map, that transforms an arbitrary simplex in \mathbb{R}^n into a regular simplex in the constraint hyperplane. $\sum_{k=1}^{n+1} z_k = 1$. By virtue of Lemma A.3, the circumscribing ellipsoid with minimal ellipsoid is then the ball (A.1). By virtue of Lemma A.2, the minimal ellipsoid that contains an arbitrary simplex in \mathbb{R}^n is given by

$$\mathcal{E}^* = \{x \mid \bar{x}^T \bar{G}_i^T \bar{G}_i \bar{x} \leq 1\}.$$

This concludes the proof. □

Proof of Proposition 8.5

LEMMA A.4

The minimum volume n-dimensional ellipsoid containing the unit cube

$$X_i = \{x \in \mathbb{R}^n \mid \|x\|_\infty \leq 1\}$$

is the ball $\{x \in \mathbb{R}^n \mid x^T x \leq n\}$. □

Proof: Follows trivially from the inequality $\|x\|_2 \leq \sqrt{n} \|x\|_\infty \forall x \in \mathbb{R}^n$.

PROOF A.2—PROOF OF PROPOSITION 8.5

Follows by direct application of Lemma A.2. \square

Proof of Proposition 8.6

PROOF A.3

According to Proposition 8.4, the outer ellipsoidal approximation is given by

$$\bar{S}_i = \begin{bmatrix} 0_{n \times n} & 0 \\ 0_{1 \times n} & 1 \end{bmatrix} - \bar{E}_i^T \bar{E}_i$$

Let $\bar{0} = [0_{1 \times n} \ 1]$ and $\bar{1} = [1_{1 \times n} \ 1]$. From the computation of \bar{E}_i , Equations (8.4), (8.5), we have

$$\bar{1}^T \bar{E}_i = \bar{0}^T$$

and thus

$$u_i \bar{S}_i = u_i \bar{E}_i^T (\bar{0} \bar{0}^T - I) \bar{E}_i$$

This expression is on the form $\bar{E}_i^T U_i \bar{E}_i$ with $u_{ij} = u_i$ if $i \neq j$ and 0 otherwise. This concludes the first part of the proof.

For the second part of the proof, consider the simplex

$$X_i = \left\{ x \mid x \in \overline{\text{co}} \left(\begin{bmatrix} 1 \\ 1 \end{bmatrix}, \begin{bmatrix} 2 \\ 1 \end{bmatrix}, \begin{bmatrix} 1 \\ 2 \end{bmatrix} \right) \right\}$$

for which we have

$$\bar{E}_i = \begin{bmatrix} -1 & -1 & 3 \\ 1 & 0 & -1 \\ 0 & 1 & -1 \end{bmatrix}, \quad \bar{S}_i = \begin{bmatrix} 2 & 1 & -4 \\ 1 & 2 & -4 \\ -4 & -4 & 10 \end{bmatrix}.$$

Let

$$\bar{P}_i = \begin{bmatrix} 20 & 0 & 5 \\ 0 & 1 & 0 \\ 5 & 0 & -25 \end{bmatrix}$$

Pre- and postmultiplying the LMI (8.8) by $\bar{z} = [3 \ 6 \ 4]^T$ we obtain $-64 - 2u_i$, which is negative for all admissible values of u_i ($u_i \geq 0$). Hence,

Appendix A. Proofs

there is no solution to this LMI. However, for the formulation (8.9), it is straightforward to verify that the choice

$$U_i = \begin{bmatrix} 0 & 20 & 5 \\ 20 & 0 & 20 \\ 5 & 20 & 0 \end{bmatrix}$$

solves the LMI.

□

B

Additional Details on Examples

B.1 Further Details on the Min-Max System

Let

$$\begin{aligned}G_1(s) &= C_1(sI - A_1)^{-1}B_1 + D_1, \\G_2(s) &= C_2(sI - A_2)^{-1}B_2 + D_2, \\C(s) &= C_n(sI - A_n)^{-1}B_n + D_n.\end{aligned}$$

Written in state space form, the system equations then become

$$\begin{cases} \dot{x}_1 = A_1x_1 + B_1u \\ z = C_1x_1 \\ \dot{x}_2 = A_2x_2 + B_2z = A_2x_2 + B_2C_1x_1 \\ y = C_2x_2 \\ \dot{x}_n = A_nx_n + B_n(y_{sp} - y) = A_nx_n - B_nC_2x_2 + B_ny_{sp} \\ u_n = C_nx_n + D_n(y_{sp} - y) = -D_nC_2x_2 + C_nx_n + D_ny_{sp} \end{cases}$$

This gives the state space model for the interconnected system

$$\begin{aligned} \frac{d}{dt} \begin{bmatrix} x_1 \\ x_2 \\ x_n \end{bmatrix} &= \begin{bmatrix} A_1 & 0 & 0 \\ B_2 C_1 & A_2 & 0 \\ 0 & -B_n C_2 & A_n \end{bmatrix} \begin{bmatrix} x_1 \\ x_2 \\ x_n \end{bmatrix} + \begin{bmatrix} B_1 \\ 0 \\ 0 \end{bmatrix} u + \begin{bmatrix} 0 \\ 0 \\ B_n \end{bmatrix} y_{sp} \\ \begin{bmatrix} y \\ u_h \\ u_n \\ u_l \end{bmatrix} &= \begin{bmatrix} 0 & C_2 & 0 \\ -K_h C_1 & 0 & 0 \\ 0 & -D_n C_2 & C_n \\ -K_l C_1 & 0 & 0 \end{bmatrix} \begin{bmatrix} x_1 \\ x_2 \\ x_n \end{bmatrix} + \begin{bmatrix} 0 & 0 & 0 \\ K_h & 0 & 0 \\ 0 & D_n & 0 \\ 0 & 0 & K_l \end{bmatrix} \begin{bmatrix} z_{max} \\ y_{sp} \\ z_{min} \end{bmatrix} \end{aligned}$$

Denoting the state vector by \tilde{x} , we obtain

$$\begin{aligned} \dot{\tilde{x}} &= \tilde{A}\tilde{x} + \tilde{B}u + \tilde{B}_{sp}\tilde{u}_{sp} \\ \tilde{y} &= \tilde{C}\tilde{x} + \tilde{D}u_{sp} \end{aligned}$$

where u is generated through the min – max selector strategy.

In order to reduce the number of input variables to the min-max non-linearity, consider the outputs

$$\begin{aligned} v_{hl} &= u_h - u_l := \tilde{C}_{hl}\tilde{x} \\ v_{nl} &= u_n - u_l := \tilde{C}_{nl}\tilde{x} \\ v_{ll} &= u_l - u_l = 0 \end{aligned}$$

and note that the input u now can be written as

$$\min(v_{hl}, \max(v_{nl}, 0)) + u_l := \varphi(v_{hl}, v_{nl}) + u_l.$$

Note that u_l This implies that we can consider analysis of the system in Figure 4.11 where $\tilde{G}(s)$ is the transfer matrix for the system

$$\begin{aligned} \dot{\tilde{x}} &= (\tilde{A} + \tilde{B}\tilde{C}_l)\tilde{x} + \tilde{B}w \\ y &= \begin{bmatrix} \tilde{C}_{hl} \\ \tilde{C}_{nl} \end{bmatrix} \tilde{x}. \end{aligned}$$

where we have defined $u_l = \tilde{C}_l\tilde{x}$.

The four regions shown in Figure 4.12(right) have cell boundings

$$\tilde{E}_1 = \begin{bmatrix} -1 & 0 \\ 0 & 1 \end{bmatrix}, \quad \tilde{E}_2 = \begin{bmatrix} -1 & 1 \\ 1 & 0 \end{bmatrix}, \quad \tilde{E}_3 = \begin{bmatrix} 1 & 1 \\ 1 & -1 \end{bmatrix}, \quad \tilde{E}_4 = \begin{bmatrix} 0 & -1 \\ -1 & -1 \end{bmatrix}$$

and the continuity matrices are given by

$$\tilde{F}_1 = \begin{bmatrix} -1 & 0 \\ 0 & 1 \\ 0 & 0 \\ 0 & 0 \end{bmatrix}, \quad \tilde{F}_2 = \begin{bmatrix} 0 & 0 \\ -1 & 1 \\ 1 & 0 \\ 0 & 0 \end{bmatrix}, \quad \tilde{F}_3 = \begin{bmatrix} 0 & 0 \\ 0 & 0 \\ 1 & 1 \\ 1 & -1 \end{bmatrix}, \quad \tilde{F}_4 = \begin{bmatrix} -1 & -1 \\ 0 & 0 \\ 0 & 0 \\ 0 & -1 \end{bmatrix},$$

in the v_{nl}/v_{hl} space. To obtain the corresponding constraint matrices in \mathbb{R}^n , we post-multiply the constraint matrices by

$$\tilde{C} = \begin{bmatrix} \tilde{C}_{nl} \\ \tilde{C}_{hl} \end{bmatrix}.$$

In other words, $E_i = \tilde{E}_i \tilde{C}$, and $F_i = \tilde{F}_i \tilde{C}$. Further details on the computation of constraint matrices are given in Chapter 8.

C

Bibliography

- [1] M. A. AISERMAN and F. GANTMACHER. *Die absolute Stabilität von Regelsystemen*, chapter II, p. 33. R. Oldenburg Verlag, 1965.
- [2] A. ANDRONOV and C. CHAIKIN. *Theory of Oscillations*. Princeton University Press, Princeton, NJ, 1949.
- [3] K.-E. ÅRZÉN, M. JOHANSSON, and R. BABUSKA. “A survey on fuzzy control.” Technical Report, Esprit LTR project FAMIMO Deliverable D1.1B, 1998.
- [4] K. J. ÅSTRÖM and T. HÄGGLUND. *PID Controllers: Theory, Design, and Tuning*. Instrument Society of America, Research Triangle Park, NC, second edition, 1995.
- [5] D. P. ATHERTON, O. P. MCNAMARA, and A. GOUCEM. “Suns: The sussex university nonlinear control systems software.” In *Preprints of the 3rd IFAC/IFIP International Symposium CADCE’85*, pp. 173–178, 1985.
- [6] D. AVIS, D. BREMNER, and R. SEIDEL. “How good are convex hull algorithms.” *Computational Geometry: Theory and Applications*, **7**, pp. 265–301, 1997.
- [7] R. BABUŠKA, H. TE BRAAKE A.J. KRIJGSMAN, and H. VERBRUGGEN. “Comparison of intelligent control schemes for real-time pressure control.” *Control Engineering Practice*, **4:11**, pp. 1585–1592, 1996.
- [8] K. BALL. “Ellipsoids of maximal volume in convex bodies.” *Geom. Dedicata*, **41:2**, pp. 241–250, 1992.
- [9] S. P. BANKS and S. A. KHATHUR. “Structure and control of piecewise-linear systems.” *International Journal of Control*, **50:2**, pp. 667–686, 1989.
- [10] R. BELLMAN. *Dynamic Programming*. Princeton University Press, New Jersey, 1957.

- [11] R. BELLMAN and K. FAN. “On systems of linear inequalities in hermitian matrix variables.” In KLEE, Ed., *Convexity (Volume 7 of Proceedings of Symposia in Pure Mathematics)*, pp. 1–11. American Mathematical Society, 1963.
- [12] J. BERNUSSOU, P. L. D. PERES, and J. C. GEROMEL. “A linear programming oriented procedure for quadratic stabilization of uncertain systems.” *Systems and Control Letters*, **13**, pp. 65–72, 1989.
- [13] D. P. BERTSEKAS and J. TSITSIKLIS. *Neuro-Dynamic Programming*. Athena Scientific, 1996.
- [14] S. A. BILLINGS and W. S. F. VOON. “Piecewise linear identification of non-linear systems.” *International Journal of Control*, **46**, pp. 215–235, 1987.
- [15] F. BLANCHINI. “Set invariance in control – a survey.” *Automatica*. Accepted for publication.
- [16] F. BLANCHINI. “Nonquadratic Lyapunov functions for robust control.” *Automatica*, **31:3**, pp. 451–461, 1995.
- [17] F. BLANCHINI and M. SZNAIER. “Persistent disturbance rejection via static state feedback.” *IEEE Transactions on Automatic Control*, **40:6**, pp. 1127–1131, 1995.
- [18] V. D. BLONDEL and J. N. TSITSIKLIS. “A survey of computational complexity results in systems and control.” Technical Report, University of Liege, Institute of Mathematics, Belgium, 1998.
- [19] S. BOYD, L. EL GHAOU, E. FERON, and V. BALAKRISHNAN. *Linear Matrix Inequalities in System and Control Theory*. SIAM Studies in Applied Mathematics, 1994.
- [20] S. BOYD and Q. YANG. “Structured and simultaneous Lyapunov functions for system stability problems.” *International Journal of Control*, **49:6**, pp. 2215–2240, 1989.
- [21] M. S. BRANICKY. “Analysis of continuous switching systems: Theory and examples.” In *Proc. American Control Conference*, pp. 3110–3114, Baltimore, MD, 1994.
- [22] M. S. BRANICKY. “Stability of switched hybrid systems.” In *Proceedings of the 33rd CDC*, pp. 3498–3503, Lake Buena Vista, FL, 1994.
- [23] M. S. BRANICKY. *Studies in Hybrid Systems: Modeling, Analysis and Control*. PhD thesis LIDS-TH-2304, Department of Electrical Engineering and Computer Science, M.I.T., Cambridge, MA, 1995.

- [24] R. K. BRAYTON and C. H. TONG. “Stability of dynamical systems: A constructive approach.” *IEEE Transaction on Circuits and Systems*, **26**, pp. 224–234, 1979.
- [25] R. K. BRAYTON and C. H. TONG. “Constructive stability and asymptotic stability of dynamical systems.” *IEEE Transactions on Circuits and Systems*, **27**, pp. 1121–1130, 1980.
- [26] L. BREIMAN. “Hinging hyperplanes for regression, classification, and function approximation.” *IEEE Transactions on Information Theory*, **39:3**, pp. 999–1013, 1993.
- [27] A. BRØNSTED. *An Introduction to Convex Polytopes*. Springer-Verlag, 1983.
- [28] H. W. BUURMAN. *From Circuit to Signal – Development of a Piecewise Linear Simulator*. PhD thesis, Eindhoven University of Technology, Eindhoven, the Netherlands, 1993.
- [29] M. J. CHIEN and E. S. KUH. “Solving nonlinear resistive networks using piecewise-linear analysis and simplicial subdivision.” *IEEE Trans. Circuits and Systems*, **CAS-24**, pp. 305–317, 1977.
- [30] L. CHUA. “Section-wise piecewise linear functions. Canonical representation, properties and applications.” *Proceedings of the IEEE*, **65**, pp. 915–929, 1977.
- [31] L. O. CHUA, C. A. DESOER, and E. S. KUH. *Linear and Nonlinear Circuits*. McGraw-Hill, New-York, 1987.
- [32] L. O. CHUA and R. L. P. YING. “Finding all solutions of piecewise-linear circuits.” *Circuit Theory and Applications*, **10**, pp. 201–229, 1982.
- [33] M. CORLESS. “Robust stability analysis and controller design with quadratic Lyapunov functions.” In ZINOBER, Ed., *Variable Structure and Lyapunov Control*, Lecture notes in Control and Information Sciences, chapter 9, pp. 181–203. Springer Verlag, 1994.
- [34] J. CZYZYK, S. MEHROTRA, M. WAGNER, and S. J. WRIGHT. “Pcx user guide (version 1.1).” Technical Report OTC 96/01, Optimization Technology Center, 1997.
- [35] G. B. DANTZIG. “Maximizing a linear function of variables subject to linear inequalities.” In KOOPMANS, Ed., *Activity Analysis of Production and Allocation*, pp. 339–347. Wiley, New York, 1951.
- [36] P. DIANANDA. “On non-negative forms in real variables some or all of which are non-negative.” *Proceedings of the Cambridge Philosophical Society*, **58**, pp. 17–25, 1962.

- [37] C. FANTUZZI and R. ROVATTI. “On the approximation capabilities of the homogeneous Takagi-Sugeno model.” In *Proceedings of the Fifth IEEE International Conference on Fuzzy Systems*, pp. 1067–1072, New Orleans, USA, 1996.
- [38] G. FENG, S. G. CAO, N. W. REES, and C. CHENG. “Analysis and design of model based fuzzy control systems.” In *Proceedings of the sixth IEEE Conference on Fuzzy Systems*, pp. 901–906, 1997.
- [39] A. F. FILIPPOV. *Differential Equations with Discontinuous Right-hand Sides*. Kluwer Academic Publishers, 1988.
- [40] I. FLÜGGE-LOTZ. *Discontinuous and Optimal Control*. McGraw-Hill, New York, 1968.
- [41] A. M. FOSS. “Criterion to assess stability of a ‘lowest wins’ control strategy.” *IEEE Proc. Pt. D*, **128:1**, pp. 1–8, 1981.
- [42] P. GAHINET, A. NEMIROVSKI, A. J. LAUB, and M. CHILALI. *LMI Control Toolbox for use with Matlab*. The Mathworks Inc., 1995.
- [43] G. GÜZELIS and I. GÖKNAR. “A canonical representation for piecewise linear affine maps and its application to circuit analysis.” *IEEE Trans. Circ. and Syst.*, **38**, pp. 1342–1354, 1991.
- [44] A. HASSIBI and S. BOYD. “Quadratic stabilization and control of piecewise-linear systems.” In *Proceedings of the 1998 American Control Conference*, pp. 3659–64, Philadelphia, PA, USA, 1998.
- [45] K. X. HE and M. D. LEMMON. “Lyapunov stability of continuous valued systems under the supervision of discrete event transition systems.” In *Proceedings of Hybrid Systems: Control and Computation*, vol. 1386 of *Lecture Notes in Computer Science*. Springer Verlag, 1998.
- [46] S. HEDLUND and M. JOHANSSON. “A toolbox for computational analysis of piecewise linear systems.” In *Submitted to the 1999 European Control Conference*, 1999.
- [47] D. HILL and P. MOYLAN. “The stability of nonlinear dissipative systems.” *IEEE Transactions on Automatic Control*, **21**, pp. 708–711, 1976.
- [48] A. P. HORISBERGER and P. R. BÉLANGER. “Regulators for linear, time invariant plants with uncertain parameters.” *IEEE Transactions on Automatic Control*, **21**, pp. 705–708, 1976.
- [49] C. S. HSU. “A theory of cell to cell mapping of dynamical systems.” *Journal of Applied Mechanics*, **47**, 1980.

- [50] M. IRI. "A method of multi-dimensional linear interpolation." *J. Inform. Processing Soc. of Japan*, pp. 211–215, 1967.
- [51] A. ISIDORI. *Nonlinear Control Systems*. Springer-Verlag, third edition, 1995.
- [52] D. H. JACOBSON. *Extensions of Linear-Quadratic Control Theory*. Springer Verlag, 1980.
- [53] M. R. JAMES. "Recent developments in nonlinear H_∞ control." In *Proceeding of the IFAC Symposium on Nonlinear Control System Design, NOLCOS'95*, Lake Tahoe, 1995.
- [54] M. R. JAMES and S. YULIAR. "Numerical approximation of the H_∞ norm for nonlinear systems." *Automatica*, **31:8**, pp. 1075–1086, 1995.
- [55] M. JIRSTRAND. *Constructive Methods for Inequality Constraints in Control*. PhD thesis 527, Department of Electrical Engineering, Linköping University, 1998.
- [56] T. A. JOHANSEN and B. A. FOSS. "Operating regime based process modeling and identification." *Computers and Chemical Engineering*, **21**, pp. 159–176, 1997.
- [57] K. H. JOHANSSON. *Relay Feedback and Multivariable Control*. PhD thesis ISRN LUTFD2/TFRT-1048--SE, Department of Automatic Control, Lund Institute of Technology, Lund, Sweden, September 1997.
- [58] M. JOHANSSON. "Analysis of piecewise linear systems via convex optimization – a unifying approach." In *Proceedings of the 1999 IFAC World Congress*, Beijing, China, 1999. To appear.
- [59] M. JOHANSSON. "Analysis of piecewise linear systems via convex optimization – a unifying approach." In *Proceedings of the 1999 IFAC World Congress*, Beijing, China, 1999. To appear.
- [60] M. JOHANSSON, A. GHULCHAK, and A. RANTZER. "Improving efficiency in the computation of piecewise quadratic Lyapunov functions." In *Proceedings of the 7th IEEE Mediterranean Conference in Control and Automation*, Haifa, Israel, 1999. To appear.
- [61] M. JOHANSSON, A. GHULCHAK, and A. RANTZER. "Improving efficiency in the computation of piecewise quadratic Lyapunov functions." In *Proceedings of the 7th IEEE Mediterranean Conference in Control and Automation*, Haifa, Israel, 1999. To appear.

- [62] M. JOHANSSON, J. MALMBORG, A. RANTZER, B. BERNHARDSSON, and K.-E. ÅRZÉN. “Modeling and control of fuzzy, heterogeneous and hybrid systems.” In *Proceedings of the SiCiCa 1997*, Annecy, France, June 1997.
- [63] M. JOHANSSON and A. RANTZER. “Computation of piecewise quadratic Lyapunov functions for hybrid systems.” Technical Report ISRN LUTFD2/TFRT-7459--SE, Department of Automatic Control, June 1996.
- [64] M. JOHANSSON and A. RANTZER. “On the computation of piecewise quadratic Lyapunov functions.” In *Proceedings of the 36th IEEE Conference on Decision and Control*, San Diego, USA, December 1997.
- [65] M. JOHANSSON and A. RANTZER. “Computation of piecewise quadratic Lyapunov functions for hybrid systems.” *IEEE Transactions on Automatic Control*, 1998. Special issue on Hybrid Systems. Also appeared as conference article in the 1997 European Control Conference, Brussels, Belgium. July 1997.
- [66] M. JOHANSSON and A. RANTZER. “Computation of piecewise quadratic Lyapunov functions for hybrid systems.” *IEEE Transactions on Automatic Control*, 1998. Special issue on Hybrid Systems.
- [67] M. JOHANSSON, A. RANTZER, and K.-E. ÅRZÉN. “A piecewise quadratic approach to stability analysis of fuzzy systems.” In *Stability Issues in Fuzzy Control*. Springer-Verlag, 1998. To appear.
- [68] M. JOHANSSON, A. RANTZER, and K.-E. ÅRZÉN. “Piecewise quadratic stability of fuzzy systems.” Submitted for journal publication. Also appeared as the conference article “Piecewise quadratic stability of affine Sugeno systems” in the 7th IEEE International Conference on Fuzzy Systems, Fuzz-IEEE, Anchorage, Alaska, May 1998. 1998.
- [69] F. JOHN. “Extremum problems with inequalities as subsidiary conditions.” In *Studies and Essays presented to R. Courant on his 60th birthday, January 8, 1948*, pp. 187–204. Interscience Publ. Inc., New York, 1948.
- [70] U. JÖNSSON. *Robustness Analysis of Uncertain and Nonlinear Systems*. PhD thesis ISRN LUTFD2/TFRT-1047--SE, Department of Automatic Control, Lund Institute of Technology, Lund, Sweden, September 1996.
- [71] C. KAHLERT and L. O. CHUA. “A generalized canonical piecewise linear representation.” *IEEE Trans. Circ. Syst.*, **37**, pp. 373–382, 1990.

- [72] T. KAILATH. *Linear Systems*. Prentice-Hall, Inc, Englewood Cliffs, New Jersey, 1980.
- [73] R. KALMAN. "Phase-plane analysis of automatic control systems with nonlinear gain elements." *Trans. AIEEE Part II: Applications and Industry*, **73**, pp. 383–390, 1954.
- [74] R. E. KALMAN. "Contributions to the theory of optimal control." *Bol. de Soc. Math. Mexicana*, p. 102, 1960.
- [75] M. KANTNER. "Robust stability of piecewise linear discrete time systems." In *Proceedings of the American Control Conference*, 1997.
- [76] N. KARMARKAR. "A new polynomial-time algorithm for linear programming." *Combinatorics*, **4**, pp. 373–395, 1984.
- [77] T. A. M. KEVENAAR, D. M. W. LEENAERTS, and W. M. G. VAN BOKHOVEN. "Extensions to Chua's explicit piecewise-linear function descriptions." *IEEE Tran. Circ and Syst.*, **41**, pp. 308–314, 1994.
- [78] H. K. KHALIL. *Nonlinear Systems*. Prentice Hall, Upper Saddle River, N.J., second edition, 1996.
- [79] H. KIENDL. "Calculation of the maximum absolute values of dynamical variables in linear control systems." *IEEE Transactions on Automatic Control*, **27:1**, 1980.
- [80] H. KIENDL and J. RÜGER. "Stability analysis of fuzzy control systems using facet functions." *Fuzzy Sets and Systems*, **70**, pp. 275–285, 1995.
- [81] A. KITAHARA, A. SATO, M. HOSHINO, N. KURIHARA, and S. SHIN. "LQG based electronic throttle control with a two degree of freedom structure." In *Proceedings of the 35th IEEE Conference on Decision and Control*, 1996.
- [82] C. W. LEE. "Subdivisions and triangulations of polytopes." In GOODMAN AND O'ROURKE, Eds., *Handbook of Discrete and Computational Geometry*, chapter 14, pp. 271–290. CRC Press LLC, 1997.
- [83] K. K. LEE and A. ARAPOSTATHIS. "On the controllability of piecewise-linear hypersurface systems." *System & Control Letters*, **9**, pp. 89–96, 1987.
- [84] D. LEENAERTS. "Further extensions to Chua's explicit piecewise linear function descriptions." *International Journal Circuit Theory and Application*, **24**, pp. 621–633, 1996.

- [85] B. LENZE. “On constructive one-sided spline approximation.” In CHUI *et al.*, Eds., *Approximation Theory VI*, vol. 2, pp. 383–386. Academic Press, 1989.
- [86] J.-N. LIN and R. UNBEHAUEN. “Canonical representation: From piecewise-linear function to piecewise-smooth functions.” *IEEE Transactions on Circuits and Systems– I*, **40:7**, pp. 461–467, 1993.
- [87] P. LÖTSTEDT. “Mechanical systems of rigid bodies subject to unilateral constraints.” *SIAM Journal on Applied Mathematics*, **42**, pp. 281–296, 1982.
- [88] A. LURE and V. POSTNIKOV. “On the theory of stability of control systems.” *Prikl. Mat. i Mekh*, pp. 3–13, 1944.
- [89] A. M. LYAPUNOV. *The general problem of the stability of motion (in Russian)*, vol. Collected Works II. Kharkov Mathematical Society, 1892.
- [90] A. M. LYAPUNOV. “The general problem of the stability of motion (translated into English by A. T. Fuller).” *Int. Journal of Control*, **55**, pp. 531–773, 1992. Also published as a book by Taylor & Francis, London.
- [91] J. MALMBORG. *Analysis and Design of Hybrid Control Systems*. PhD thesis ISRN LUTFD2/TFRT--1050--SE, Department of Automatic Control, Lund Institute of Technology, Lund, Sweden, May 1998.
- [92] S. E. MATTSSON. “On object-oriented modeling of relays and sliding mode behaviour.” In *IFAC'96, Preprints 13th World Congress of IFAC*, vol. F, pp. 259–264, San Francisco, California, July 1996.
- [93] A. MEGRETSKI, C.-Y. KAO, U. JONSSON, and A. RANTZER. “IQC β : A collection of Matlab routines for robustness analysis.” Available from <http://www.mit.edu/people/ameg>.
- [94] A. MEGRETSKI and A. RANTZER. “System analysis via Integral Quadratic Constraints.” *IEEE Transactions on Automatic Control*, **47:6**, pp. 819–830, June 1997.
- [95] A. N. MICHEL, B. H. NAM, and V. VITTAL. “Computer generated Lyapunov functions for interconnected systems: Improved results with application to power systems.” *IEEE Transactions on Circuits and Systems*, **31**, pp. 189–198, 1984.
- [96] A. MOLCHANOV and E. PYATNITSKII. “Lyapunov functions that specify necessary and sufficient conditions for absolute stability of nonlinear systems III.” *Automation and Remote Control*, **47**, pp. 620–630, 1986.

- [97] R. MURRAY-SMITH and T. A. J. (EDS.). *Multiple Model Approaches to Modelling and Control*. Taylor and Francis, London, 1997.
- [98] A. NAKAMURA and N. HAMADA. “Nonlinear dynamical system identification by piecewise-linear system.” In *Proceedings of the 1990 IEEE International Symposium on Circuits and Systems*, pp. 1454–1457. IEEE, 1990.
- [99] Y. NESTEROV and A. NEMIROVSKI. *Interior point polynomial methods in convex programming*, vol. 13 of *Studies in Applied Mathematics*. SIAM, Philadelphia, 1993.
- [100] Y. NESTEROV and A. NEMIROVSKY. “A general approach to polynomial-time algorithms design for convex programming.” Technical Report, Centr. Econ. & Math. Inst., USSR Acad. Sci, Moscow, USSR, 1988.
- [101] H. NIJMEIJER and A. SCHAFT VAN DER. *Nonlinear Dynamical Control Systems*. Springer-Verlag, New York, 1990.
- [102] Y. OHTA, H. IMANISHI, L. GONG, and H. HANEDA. “Computer generated Lyapunov functions for a class of nonlinear systems.” *IEEE Transactions on Circuits and Systems – I*, **40:5**, pp. 343–354, 1993.
- [103] T. OHTSUKI and N. YOSHIDA. “DC analysis of nonlinear networks based on generalized piecewise-linear characterization.” *IEEE Tran. Circuit Theory*, **CT-18**, pp. 146–151, 1971.
- [104] A. OLAS. “On robustness of systems with structured uncertainties.” In *Proc. 4th Workshop on Control Mechanics*, University of Southern California, 1991.
- [105] S. PASTORE and A. PREMOLI. “Polyhedral elements: A new algorithm for capturing all the equilibrium points of piecewise-linear circuits.” *IEEE Trans. Circuits. Syst.*, **40**, pp. 124–131, 1993.
- [106] T. PAVLIDIS. “Stability of systems described by differential equations containing impulses.” *IEEE Transactions on Automatic Control*, **12:1**, pp. 43–45, 1967.
- [107] P. PELETIES and R. DECARLO. “Asymptotic stability of m-switched systems using Lyapunov-like functions.” In *Proc. ACC*, pp. 1679–1683, Boston, 1991.
- [108] S. PETTERSSON. *Modelling, Control and Stability Analysis of Hybrid Systems*. Licentiate thesis Technical Report No.247L, Chalmers University of Technology, 1996.

- [109] S. PETERSSON. "Stability and robustness for hybrid system." Technical Report CTH/RT/I-96/003, Control Engineering Lab, Chalmers University of Technology, Gothenburg, Sweden, July 1996.
- [110] N. B. O. L. PETTIT. *Analysis of Piecewise Linear Dynamical Systems*. Research Studies Press Ltd. / John Wiley & Sons Limited, 1995.
- [111] A. POLAŃSKI. "On infinity norms as Lyapunov functions for linear systems." *IEEE Transactions on Automatic Control*, **40:7**, pp. 1270–1274, 1995.
- [112] S. POLJAK, F. RENDL, and H. WOLKOWICZ. "A recipe for best semidefinite relaxation for (0,1)-quadratic programming." Technical Report CORR 94-7, University of Waterloo, 1994.
- [113] V. POPOV. "Absolute stability of nonlinear systems of automatic control." *Automation and Remote Control*, **22**, pp. 857–875, 1961.
- [114] V. POPOV. "Absolute stability of nonlinear systems of automatic control." *Automation and Remote Control*, **22**, pp. 857–875, 1962. Russian original in August 1961.
- [115] V. POPOV. *Hyperstability of Control Systems*. Springer Verlag, New York, 1973.
- [116] H. M. POWER and A. C. TSOI. "Improving the predictions of the circle criterion by combining quadratic forms." *IEEE Transactions on Automatic Control*, **18:1**, pp. 65–67, 1973.
- [117] E. S. PYATNITSKII and V. I. SKORODINSKII. "Numerical methods of Lyapunov function construction and their application to the absolute stability problem." *System. Control Letters*, **2:2**, pp. 130–135, 1982.
- [118] A. RANTZER. "Dynamic programming via convex optimization." In *Proceedings of the 1999 IFAC World Congress*, Beijing, China, 1999.
- [119] A. RANTZER and M. JOHANSSON. "Piecewise linear quadratic optimal control." *IEEE Transactions on Automatic Control*, 1998. Accepted for publication. Also appeared as conference article in the 1997 American Control Conference, Albuquerque, N.M., June 1997.
- [120] A. RANTZER and M. JOHANSSON. "Piecewise linear quadratic optimal control." *IEEE Transactions on Automatic Control*, 1998. Accepted for publication.
- [121] W. J. RUGH. *Linear System Theory*. Prentice Hall, Englewood Cliffs, N.J., 1993.

- [122] C. SCHERER and S. WEILAND. “Linear matrix inequalities in control.” DISC (Dutch graduate school in control) Lecture Notes, 1997.
- [123] A. SCHRIJVER. *Theory of Integer and Linear Programming*. Wiley, Chichester, 1986.
- [124] J. W. SCHWARTZ. “Piecewise linear servomechanisms.” *AIEE Transactions*, **72**, pp. 401–405, 1953.
- [125] T. SEIDMAN. “Some limit problems for relays.” In *Proc. of the 1st WCNA*, pp. 787–796, Tampa, Fl., 1992.
- [126] J. SHAMMA. “Optimization of the l^∞ -induced norm under full state feedback.” *IEEE Transaction of Automatic Control*, **41:4**, pp. 533–544, 1996.
- [127] D. SHEVITZ and B. PADEN. “Lyapunov stability theory of nonsmooth systems.” *IEEE Transactions on Automatic Control*, **39:9**, pp. 1910–1914, 1994.
- [128] N. Z. SHOR. “Quadratic optimization problems.” *Soviet Journal of Circuits and Systems Sciences*, **25:6**, pp. 1–11, 1987.
- [129] A. SKEPPSTEDT, L. LJUNG, and M. MILLNERT. “Construction of composite models from observed data.” *International Journal of Control*, **55**, pp. 141–152, 1992.
- [130] J.-J. E. SLOITINE and W. LI. *Applied Nonlinear Control*. Prentice Hall, Englewood Cliffs, N.J., 1991.
- [131] E. SONTAG. “Nonlinear regulation: The piecewise linear approach.” *IEEE Transactions on Automatic Control*, **26**, pp. 346–358, 1981.
- [132] J. SOUSA, R. BABUŠKA, and H. VERBRUGGEN. “Fuzzy predictive control applied to an air-conditioning system.” *Control Engineering Practice*, **5:10**, pp. 1395–1406, 1997.
- [133] D. D. SWORDER. “Feedback control of a class of linear systems with jump parameters.” *IEEE Transactions on Automatic Control*, **14:1**, pp. 9–14, 1969.
- [134] T. TAKAGI and M. SUGENO. “Fuzzy identification of systems and its applications to modeling and control.” *IEEE Transactions on Systems, Man and Cybernetics*, **15:1**, pp. 116–132, 1985.
- [135] K. TANAKA, T. IKEDA, and H. O. WANG. “Robust stabilization of a class of uncertain nonlinear systems via fuzzy control: Quadratic stabilizability, H_∞ control theory and linear matrix inequalities.” *IEEE Transactions on Fuzzy Systems*, **4:1**, pp. 1–13, 1996.

- [136] L. TAVERNINI. “Differential automata and their discrete simulators.” *Nonlinear Analysis, Theory, Methods and Applications*, **11:6**, pp. 665–683, 1987.
- [137] H. D. TUAN, S. HOSOE, and H. TUY. “D.C. optimization approach to robust control: feasibility problems.” Technical Report Technical Report 9601, Dep. of Electronic-Mechanical Engineering at Nagoya University, Nagoya, Japan, 1997.
- [138] V. I. UTKIN. “Variable structure systems with sliding modes.” *IEEE Transactions on Automatic Control*, **AC-22**, pp. 212–222, 1977.
- [139] W. M. G. VAN BOKHOVEN. *Piecewise Linear Modelling and Analysis*. Kluwer Technische boeken, Deventer, the Netherlands, 1981.
- [140] A. J. VAN DER SCHAFT. “ L_2 -gain analysis of nonlinear systems and nonlinear state feedback H_∞ control.” *IEEE Transactions on Automatic Control*, **37:6**, 1992.
- [141] A. J. VAN DER SCHAFT and J. M. SCHUMACHER. “The complementary-slackness class of hybrid systems.” *Mathematics of Control, Signals and Systems*, **9**, pp. 266–301, 1996.
- [142] L. VANDENBERGHE and S. BOYD. “A polynomial-time algorithm for determining quadratic Lyapunov functions for nonlinear systems.” In *Eur. Conf. Circuit Th. and Design*, pp. 1065–1068, 1993.
- [143] L. VANDENBERGHE, S. BOYD, and S.-P. WU. “Determinant maximization with linear matrix inequality constraints.” *SIAM Journal on Matrix Analysis and Applications*, **19:2**, pp. 499–533, 1998.
- [144] L. VANDENBERGHE, B. L. D. MOOR, and J. VANDERWALLE. “The generalized linear complementarity problem applied to the complete analysis of resistive piecewise-linear circuits.” *IEEE Trans. Circuits. Syst.*, **36**, pp. 1382–1391, 1989.
- [145] V. M. VELIOV and M. I. KRASTANOV. “Controllability of piecewise linear systems.” *System & Control Letters*, **7**, pp. 335–341, 1986.
- [146] R. B. VINTER and R. M. LEWIS. “A necessary and sufficient condition for optimality of dynamic programming type, making no a priori assumptions on the controls.” *SIAM Journal on Control and Optimization*, **16:4**, pp. 571–583, 1978.
- [147] L.-X. WANG. *Adaptive Fuzzy Systems and Control: Design and Stability Analysis*. Prentice Hall, 1994.
- [148] J. WILLEMS. “The least squares stationary optimal control and the algebraic Riccati equation.” *IEEE Transactions on Automatic Control*, **16:6**, pp. 621–634, 1971.

- [149] J. WILLEMS. “Dissipative dynamical systems, part I: General theory; part II: Linear systems with quadratic supply rates.” *Arch. Rational Mechanics and Analysis*, **45:5**, pp. 321–393, 1972.
- [150] G. F. WREDENHAGEN and P. R. BELANGER. “Piecewise-linear LQ control for systems with input constraints.” *Automatica*, **30:3**, pp. 403–416, 1994.
- [151] S.-P. WU and S. BOYD. “Design and implementation of a parser/solver for SDPs with matrix structure.” In *Proc. of IEEE Conf. on Computer Aided Control System Design*, 1996.
- [152] V. YAKUBOVICH. “The method of matrix inequalities in the theory of stability of nonlinear control systems, Part I-III.” *Avtomatika i Telemekhanika*, 1964. 25(7):1017-1029, 26(4):577-599, 1964, 26(5): 753-763, 1965, (English translation in *Autom. Remote Control*).
- [153] V. YAKUBOVICH. “S-procedure in nonlinear control theory.” *Vestnik Leningrad University*, pp. 62–77, 1971. (English translation in *Vestnik Leningrad Univ.* 4:73-93, 1977).
- [154] C. YFOULIS, A. MUIR, N. PETTIT, and P. WELLSTEAD. “Stabilization of orthogonal piecewise linear systems using piecewise linear Lyapunov-like functions.” In *Proceedings of the 37th IEEE CDC*, Tampa, Florida, 1998.
- [155] G. ZAMES and P. FALB. “Stability conditions for systems with monotone and slope-restricted nonlinearities.” *SIAM Journal of Control*, **6:1**, pp. 89–108, 1968.
- [156] J. ZHAO. *System Modeling, Identification and Control using Fuzzy Logic*. PhD thesis, Université Catholique de Louvain, Belgium, 1995.
- [157] G. M. ZIEGLER. *Lectures on Polytopes*. Springer-Verlag, 1994.